

Dimensions and weights . . . . .	REF•1	Tools and working facilities . . . . .	REF•6
Conversion factors . . . . .	REF•2	MOT test checks . . . . .	REF•8
Buying spare parts . . . . .	REF•3	Fault finding . . . . .	REF•12
Vehicle identification . . . . .	REF•3	Glossary of technical terms . . . . .	REF•19
General repair procedures . . . . .	REF•4	Index . . . . .	REF•23
Jacking and vehicle support . . . . .	REF•5		



## Dimensions and weights

**Note:** All figures are approximate, and may vary according to model. Refer to manufacturer's data for exact figures.

### Dimensions

Overall length:	
Hatchback . . . . .	.4230 mm
Estate . . . . .	.4394 mm
Overall height*:	
Hatchback . . . . .	.1358 mm
Estate . . . . .	.1428 mm
Overall width . . . . .	.1660 mm
Ground clearance* . . . . .	.160 mm

\*Engine running - normal setting

### Weights

Kerb weight:	
BX . . . . .	.900 kg
BX 14 . . . . .	.900 kg
BX 16 . . . . .	.950 kg
BX 16 Estate . . . . .	.998 kg
BX 19 . . . . .	1000 kg
BX 19 Estate . . . . .	1037 kg
BX 19 GTi . . . . .	1025 kg
BX 19 GTi 16v . . . . .	1070 kg

### Weights (continued)

Maximum towing weight:	
BX . . . . .	.1000 kg
BX 14 . . . . .	.1000 kg
BX 16 . . . . .	.1100 kg
BX 16 Estate . . . . .	.1100 kg
BX 19 . . . . .	.1100 kg
BX 19 Estate . . . . .	.1100 kg
BX 19 GTi . . . . .	.1100 kg
BX 19 GTi 16v . . . . .	.1100 kg
Maximum roof rack load:	
Hatchback . . . . .	.75 kg
Estate . . . . .	.100 kg

# REF•2 Conversion factors

## Length (distance)

Inches (in)	x 25.4 = Millimetres (mm)	x 0.0394 = Inches (in)
Feet (ft)	x 0.305 = Metres (m)	x 3.281 = Feet (ft)
Miles	x 1.609 = Kilometres (km)	x 0.621 = Miles

## Volume (capacity)

Cubic inches (cu in; in <sup>3</sup> )	x 16.387 = Cubic centimetres (cc; cm <sup>3</sup> )	x 0.061 = Cubic inches (cu in; in <sup>3</sup> )
Imperial pints (Imp pt)	x 0.568 = Litres (l)	x 1.76 = Imperial pints (Imp pt)
Imperial quarts (Imp qt)	x 1.137 = Litres (l)	x 0.88 = Imperial quarts (Imp qt)
Imperial quarts (Imp qt)	x 1.201 = US quarts (US qt)	x 0.833 = Imperial quarts (Imp qt)
US quarts (US qt)	x 0.946 = Litres (l)	x 1.057 = US quarts (US qt)
Imperial gallons (Imp gal)	x 4.546 = Litres (l)	x 0.22 = Imperial gallons (Imp gal)
Imperial gallons (Imp gal)	x 1.201 = US gallons (US gal)	x 0.833 = Imperial gallons (Imp gal)
US gallons (US gal)	x 3.785 = Litres (l)	x 0.264 = US gallons (US gal)

## Mass (weight)

Ounces (oz)	x 28.35 = Grams (g)	x 0.035 = Ounces (oz)
Pounds (lb)	x 0.454 = Kilograms (kg)	x 2.205 = Pounds (lb)

## Force

Ounces-force (ozf; oz)	x 0.278 = Newtons (N)	x 3.6 = Ounces-force (ozf; oz)
Pounds-force (lbf; lb)	x 4.448 = Newtons (N)	x 0.225 = Pounds-force (lbf; lb)
Newtons (N)	x 0.1 = Kilograms-force (kgf; kg)	x 9.81 = Newtons (N)

## Pressure

Pounds-force per square inch (psi; lbf/in <sup>2</sup> ; lb/in <sup>2</sup> )	x 0.070 = Kilograms-force per square centimetre (kgf/cm <sup>2</sup> ; kg/cm <sup>2</sup> )	x 14.223 = Pounds-force per square inch (psi; lbf/in <sup>2</sup> ; lb/in <sup>2</sup> )
Pounds-force per square inch (psi; lbf/in <sup>2</sup> ; lb/in <sup>2</sup> )	x 0.068 = Atmospheres (atm)	x 14.696 = Pounds-force per square inch (psi; lbf/in <sup>2</sup> ; lb/in <sup>2</sup> )
Pounds-force per square inch (psi; lbf/in <sup>2</sup> ; lb/in <sup>2</sup> )	x 0.069 = Bars	x 14.5 = Pounds-force per square inch (psi; lbf/in <sup>2</sup> ; lb/in <sup>2</sup> )
Pounds-force per square inch (psi; lbf/in <sup>2</sup> ; lb/in <sup>2</sup> )	x 6.895 = Kilopascals (kPa)	x 0.145 = Pounds-force per square inch (psi; lbf/in <sup>2</sup> ; lb/in <sup>2</sup> )
Kilopascals (kPa)	x 0.01 = Kilograms-force per square centimetre (kgf/cm <sup>2</sup> ; kg/cm <sup>2</sup> )	x 98.1 = Kilopascals (kPa)
Millibar (mbar)	x 100 = Pascals (Pa)	x 0.01 = Millibar (mbar)
Millibar (mbar)	x 0.0145 = Pounds-force per square inch (psi; lbf/in <sup>2</sup> ; lb/in <sup>2</sup> )	x 68.947 = Millibar (mbar)
Millibar (mbar)	x 0.75 = Millimetres of mercury (mmHg)	x 1.333 = Millibar (mbar)
Millibar (mbar)	x 0.401 = Inches of water (inH <sub>2</sub> O)	x 2.491 = Millibar (mbar)
Millimetres of mercury (mmHg)	x 0.535 = Inches of water (inH <sub>2</sub> O)	x 1.868 = Millimetres of mercury (mmHg)
Inches of water (inH <sub>2</sub> O)	x 0.036 = Pounds-force per square inch (psi; lbf/in <sup>2</sup> ; lb/in <sup>2</sup> )	x 27.68 = Inches of water (inH <sub>2</sub> O)

## Torque (moment of force)

Pounds-force inches (lbf in; lb in)	x 1.152 = Kilograms-force centimetre (kgf cm; kg cm)	x 0.868 = Pounds-force inches (lbf in; lb in)
Pounds-force inches (lbf in; lb in)	x 0.113 = Newton metres (Nm)	x 8.85 = Pounds-force inches (lbf in; lb in)
Pounds-force inches (lbf in; lb in)	x 0.083 = Pounds-force feet (lbf ft; lb ft)	x 12 = Pounds-force inches (lbf in; lb in)
Pounds-force feet (lbf ft; lb ft)	x 0.138 = Kilograms-force metres (kgf m; kg m)	x 7.233 = Pounds-force feet (lbf ft; lb ft)
Pounds-force feet (lbf ft; lb ft)	x 1.356 = Newton metres (Nm)	x 0.738 = Pounds-force feet (lbf ft; lb ft)
Newton metres (Nm)	x 0.102 = Kilograms-force metres (kgf m; kg m)	x 9.804 = Newton metres (Nm)

## Power

Horsepower (hp)	x 745.7 = Watts (W)	x 0.0013 = Horsepower (hp)
-----------------	---------------------	----------------------------

## Velocity (speed)

Miles per hour (miles/hr; mph)	x 1.609 = Kilometres per hour (km/hr; kph)	x 0.621 = Miles per hour (miles/hr; mph)
--------------------------------	--	--

## Fuel consumption\*

Miles per gallon (mpg)	x 0.354 = Kilometres per litre (km/l)	x 2.825 = Miles per gallon (mpg)
------------------------	---------------------------------------	----------------------------------

## Temperature

Degrees Fahrenheit = (°C x 1.8) + 32                      Degrees Celsius (Degrees Centigrade; °C) = (°F - 32) x 0.56

\* It is common practice to convert from miles per gallon (mpg) to litres/100 kilometres (l/100km), where mpg x l/100 km = 282

Spare parts are available from many sources, including manufacturer's appointed garages, accessory shops, and motor factors. To be sure of obtaining the correct parts, it will sometimes be necessary to quote the vehicle identification number. If possible, it can also be useful to take the old parts along for positive identification. Items such as starter motors and alternators may be available under a service exchange scheme - any parts returned should always be clean.

Our advice regarding spare part sources is as follows.

## Officially-appointed garages

This is the best source of parts which are peculiar to your vehicle, and which are not otherwise generally available (eg badges, interior trim, certain body panels, etc). It is also the only place at which you should buy parts if the vehicle is still under warranty.

## Accessory shops

These are very good places to buy materials and components needed for the maintenance of your vehicle (oil, air and fuel

filters, spark plugs, light bulbs, drivebelts, oils and greases, brake pads, touch-up paint, etc). Components of this nature sold by a reputable shop are of the same standard as those used by the vehicle manufacturer.

Besides components, these shops also sell tools and general accessories, usually have convenient opening hours, charge lower prices, and can often be found not far from home. Some accessory shops have parts counters where the components needed for almost any repair job can be purchased or ordered.

## Motor factors

Good factors will stock all the more important components which wear out comparatively quickly, and can sometimes supply individual components needed for the overhaul of a larger assembly (eg brake seals and hydraulic parts, bearing shells, pistons, valves, alternator brushes). They may also handle work such as cylinder block re boring, crankshaft regrinding and balancing, etc.

## Tyre and exhaust specialists

These outlets may be independent, or members of a local or national chain. They frequently offer competitive prices when compared with a main dealer or local garage, but it will pay to obtain several quotes before making a decision. When researching prices, also ask what "extras" may be added - for instance, fitting a new valve and balancing the wheel are both commonly charged on top of the price of a new tyre.

## Other sources

Beware of parts or materials obtained from market stalls, car boot sales or similar outlets. Such items are not invariably sub-standard, but there is little chance of compensation if they do prove unsatisfactory. In the case of safety-critical components such as brake pads, there is the risk not only of financial loss but also of an accident causing injury or death.

Second-hand components or assemblies obtained from a car breaker can be a good buy in some circumstances, but this sort of purchase is best made by the experienced DIY mechanic.

# Vehicle identification

Modifications are a continuing and unpublicised process in vehicle manufacture, quite apart from major model changes. Spare parts manuals and lists are compiled upon a numerical basis, the individual vehicle identification numbers being essential to correct identification of the component concerned.

When ordering spare parts, always give as much information as possible. Quote the vehicle model, year of manufacture, body and engine numbers as appropriate.

The *vehicle identification plate* is in the engine compartment on the right-hand side wheel arch (see illustrations). It gives the VIN (vehicle identification number).

The *engine number* location depends on engine type. On BX and BX 14 models, it is located on the bottom left-hand side of the engine. On BX 16 and BX 19 models it is located on the top right-hand side of the engine (see illustration).

The *chassis number* is stamped into the

manufacturer's plate in the engine compartment on the front panel.

*Other identification numbers* or codes are stamped on major items such as the gearbox, final drive housing, distributor etc. These numbers are unlikely to be needed by the home mechanic.

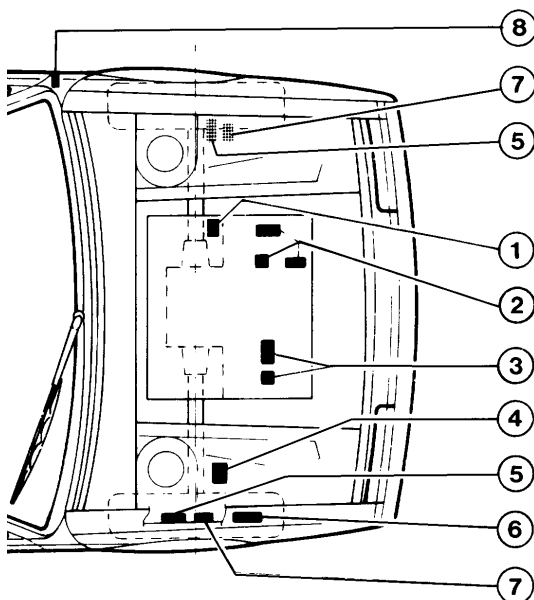

### Vehicle identification plate locations

- 1 Gearbox number
- 2 Engine number - BX and BX 14
- 3 Engine number - BX 16 and BX 19
- 4 Manufacturer's plate
- 5 Replacement parts organisation number
- 6 Chassis number
- 7 Paint reference number
- 8 Model year



Vehicle identification plate location



Engine number location - BX 16

# REF•4 General repair procedures

Whenever servicing, repair or overhaul work is carried out on the car or its components, it is necessary to observe the following procedures and instructions. This will assist in carrying out the operation efficiently and to a professional standard of workmanship.

## **Joint mating faces and gaskets**

When separating components at their mating faces, never insert screwdrivers or similar implements into the joint between the faces in order to prise them apart. This can cause severe damage which results in oil leaks, coolant leaks, etc upon reassembly. Separation is usually achieved by tapping along the joint with a soft-faced hammer in order to break the seal. However, note that this method may not be suitable where dowels are used for component location.

Where a gasket is used between the mating faces of two components, ensure that it is renewed on reassembly, and fit it dry unless otherwise stated in the repair procedure. Make sure that the mating faces are clean and dry, with all traces of old gasket removed. When cleaning a joint face, use a tool which is not likely to score or damage the face, and remove any burrs or nicks with an oilstone or fine file.

Make sure that tapped holes are cleaned with a pipe cleaner, and keep them free of jointing compound, if this is being used, unless specifically instructed otherwise.

Ensure that all orifices, channels or pipes are clear, and blow through them, preferably using compressed air.

## **Oil seals**

Oil seals can be removed by levering them out with a wide flat-bladed screwdriver or similar tool. Alternatively, a number of self-tapping screws may be screwed into the seal, and these used as a purchase for pliers or similar in order to pull the seal free.

Whenever an oil seal is removed from its working location, either individually or as part of an assembly, it should be renewed.

The very fine sealing lip of the seal is easily damaged, and will not seal if the surface it contacts is not completely clean and free from scratches, nicks or grooves. If the original sealing surface of the component cannot be restored, and the manufacturer has not made provision for slight relocation of the seal relative to the sealing surface, the component should be renewed.

Protect the lips of the seal from any surface which may damage them in the course of fitting. Use tape or a conical sleeve where possible. Lubricate the seal lips with oil before fitting and, on dual-lipped seals, fill the space between the lips with grease.

Unless otherwise stated, oil seals must be fitted with their sealing lips toward the lubricant to be sealed.

Use a tubular drift or block of wood of the appropriate size to install the seal and, if the seal housing is shouldered, drive the seal down to the shoulder. If the seal housing is

unshouldered, the seal should be fitted with its face flush with the housing top face (unless otherwise instructed).

## **Screw threads and fastenings**

Seized nuts, bolts and screws are quite a common occurrence where corrosion has set in, and the use of penetrating oil or releasing fluid will often overcome this problem if the offending item is soaked for a while before attempting to release it. The use of an impact driver may also provide a means of releasing such stubborn fastening devices, when used in conjunction with the appropriate screwdriver bit or socket. If none of these methods works, it may be necessary to resort to the careful application of heat, or the use of a hacksaw or nut splitter device.

Studs are usually removed by locking two nuts together on the threaded part, and then using a spanner on the lower nut to unscrew the stud. Studs or bolts which have broken off below the surface of the component in which they are mounted can sometimes be removed using a stud extractor. Always ensure that a blind tapped hole is completely free from oil, grease, water or other fluid before installing the bolt or stud. Failure to do this could cause the housing to crack due to the hydraulic action of the bolt or stud as it is screwed in.

When tightening a castellated nut to accept a split pin, tighten the nut to the specified torque, where applicable, and then tighten further to the next split pin hole. Never slacken the nut to align the split pin hole, unless stated in the repair procedure.

When checking or retightening a nut or bolt to a specified torque setting, slacken the nut or bolt by a quarter of a turn, and then retighten to the specified setting. However, this should not be attempted where angular tightening has been used.

For some screw fastenings, notably cylinder head bolts or nuts, torque wrench settings are no longer specified for the latter stages of tightening, "angle-tightening" being called up instead. Typically, a fairly low torque wrench setting will be applied to the bolts/nuts in the correct sequence, followed by one or more stages of tightening through specified angles.

## **Locknuts, locktabs and washers**

Any fastening which will rotate against a component or housing during tightening should always have a washer between it and the relevant component or housing.

Spring or split washers should always be renewed when they are used to lock a critical component such as a big-end bearing retaining bolt or nut. Locktabs which are folded over to retain a nut or bolt should always be renewed.

Self-locking nuts can be re-used in non-critical areas, providing resistance can be felt when the locking portion passes over the bolt or stud thread. However, it should be noted that self-locking stiffnuts tend to lose their

effectiveness after long periods of use, and should be renewed as a matter of course.

Split pins must always be replaced with new ones of the correct size for the hole.

When thread-locking compound is found on the threads of a fastener which is to be re-used, it should be cleaned off with a wire brush and solvent, and fresh compound applied on reassembly.

## **Special tools**

Some repair procedures in this manual entail the use of special tools such as a press, two or three-legged pullers, spring compressors, etc. Wherever possible, suitable readily-available alternatives to the manufacturer's special tools are described, and are shown in use. In some instances, where no alternative is possible, it has been necessary to resort to the use of a manufacturer's tool, and this has been done for reasons of safety as well as the efficient completion of the repair operation. Unless you are highly-skilled and have a thorough understanding of the procedures described, never attempt to bypass the use of any special tool when the procedure described specifies its use. Not only is there a very great risk of personal injury, but expensive damage could be caused to the components involved.

## **Environmental considerations**

When disposing of used engine oil, brake fluid, antifreeze, etc, give due consideration to any detrimental environmental effects. Do not, for instance, pour any of the above liquids down drains into the general sewage system, or onto the ground to soak away. Many local council refuse tips provide a facility for waste oil disposal, as do some garages. If none of these facilities are available, consult your local Environmental Health Department, or the National Rivers Authority, for further advice.

With the universal tightening-up of legislation regarding the emission of environmentally-harmful substances from motor vehicles, most current vehicles have tamperproof devices fitted to the main adjustment points of the fuel system. These devices are primarily designed to prevent unqualified persons from adjusting the fuel/air mixture, with the chance of a consequent increase in toxic emissions. If such devices are encountered during servicing or overhaul, they should, wherever possible, be renewed or refitted in accordance with the vehicle manufacturer's requirements or current legislation.

**Note: It is antisocial and illegal to dump oil down the drain. To find the location of your local oil recycling bank, call this number free.**



# Jacking and vehicle support REF•5

The jack supplied with the vehicle should only be used for changing the roadwheels - see "Wheel changing" at the front of this Manual. When using the jack, position it on firm ground and locate its head in the relevant vehicle jacking point.

When carrying out any other kind of work, raise the vehicle using a hydraulic (or "trolley") jack and always supplement the jack with axle stands.

When jacking-up the vehicle with a trolley jack, or supporting it on safety stands, locate

the jack or stands only at the specified support points (see illustration). Always ensure that they are securely located and the vehicle firmly supported before working underneath.

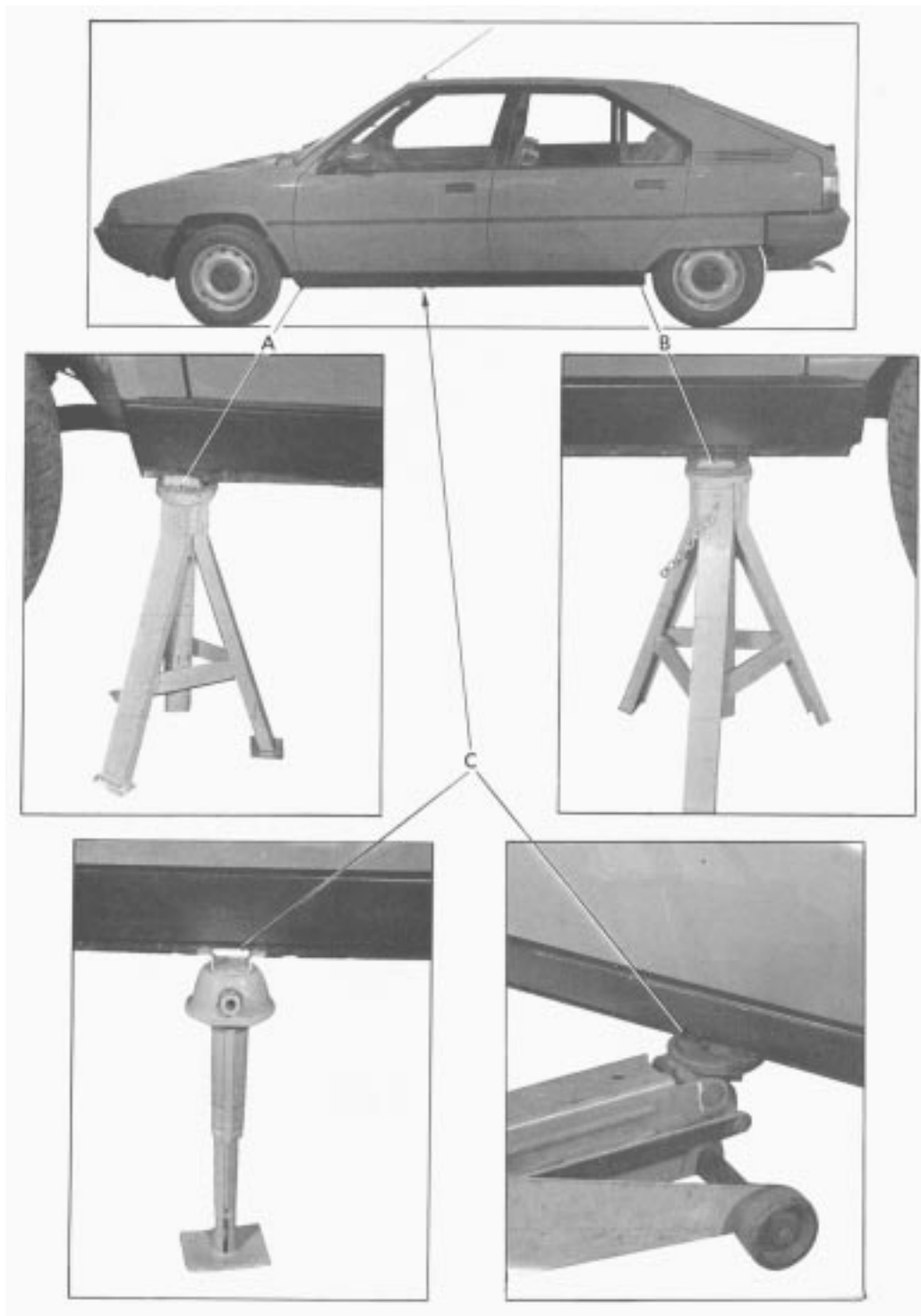

Jacking and support points

A Support stand - front    B Support stand - rear    C Jacking point

## Introduction

A selection of good tools is a fundamental requirement for anyone contemplating the maintenance and repair of a motor vehicle. For the owner who does not possess any, their purchase will prove a considerable expense, offsetting some of the savings made by doing-it-yourself. However, provided that the tools purchased meet the relevant national safety standards and are of good quality, they will last for many years and prove an extremely worthwhile investment.

To help the average owner to decide which tools are needed to carry out the various tasks detailed in this manual, we have compiled three lists of tools under the following headings: *Maintenance and minor repair*, *Repair and overhaul*, and *Special*. Newcomers to practical mechanics should start off with the *Maintenance and minor repair* tool kit, and confine themselves to the simpler jobs around the vehicle. Then, as confidence and experience grow, more difficult tasks can be undertaken, with extra tools being purchased as, and when, they are needed. In this way, a *Maintenance and minor repair* tool kit can be built up into a *Repair and overhaul* tool kit over a considerable period of time, without any major cash outlays. The experienced do-it-yourselfer will have a tool kit good enough for most repair and overhaul procedures, and will add tools from the *Special* category when it is felt that the expense is justified by the amount of use to which these tools will be put.

## Maintenance and minor repair tool kit

The tools given in this list should be considered as a minimum requirement if routine maintenance, servicing and minor repair operations are to be undertaken. We recommend the purchase of combination spanners (ring one end, open-ended the other); although more expensive than open-ended ones, they do give the advantages of both types of spanner.

- Combination spanners:*
  - Metric - 8 to 19 mm inclusive*
  - Adjustable spanner - 35 mm jaw (approx.)*
- Spark plug spanner (with rubber insert) - petrol models*
- Spark plug gap adjustment tool - petrol models*
- Set of feeler blades*
- Brake bleed nipple spanner*
- Screwdrivers:*
  - Flat blade - 100 mm long x 6 mm dia*
  - Cross blade - 100 mm long x 6 mm dia*
- Combination pliers*
- Hacksaw (junior)*
- Tyre pump*
- Tyre pressure gauge*
- Oil can*
- Oil filter removal tool*
- Fine emery cloth*
- Wire brush (small)*
- Funnel (medium size)*

## Repair and overhaul tool kit

These tools are virtually essential for anyone undertaking any major repairs to a motor vehicle, and are additional to those given in the *Maintenance and minor repair* list. Included in this list is a comprehensive set of sockets. Although these are expensive, they will be found invaluable as they are so versatile - particularly if various drives are included in the set. We recommend the half-inch square-drive type, as this can be used with most proprietary torque wrenches.

The tools in this list will sometimes need to be supplemented by tools from the *Special* list:

- Sockets (or box spanners) to cover range in previous list (including Torx sockets)*
- Reversible ratchet drive (for use with sockets)*
- Extension piece, 250 mm (for use with sockets)*
- Universal joint (for use with sockets)*
- Torque wrench (for use with sockets)*
- Self-locking grips*
- Ball pein hammer*
- Soft-faced mallet (plastic/aluminium or rubber)*
- Screwdrivers:*
  - Flat blade - long & sturdy, short (chubby), and narrow (electrician's) types*
  - Cross blade - Long & sturdy, and short (chubby) types*
- Pliers:*
  - Long-nosed*
  - Side cutters (electrician's)*
  - Circlip (internal and external)*
- Cold chisel - 25 mm*
- Scriber*
- Scrapper*
- Centre-punch*
- Pin punch*
- Hacksaw*
- Brake hose clamp*
- Brake/clutch bleeding kit*
- Selection of twist drills*
- Steel rule/straight-edge*
- Allen keys (inc. splined/Torx type)*
- Selection of files*
- Wire brush*
- Axle stands*
- Jack (strong trolley or hydraulic type)*
- Light with extension lead*



Sockets and reversible ratchet drive



Valve spring compressor



Spline bit set



Piston ring compressor



Clutch plate alignment set

## Special tools

The tools in this list are those which are not used regularly, are expensive to buy, or which need to be used in accordance with their manufacturers' instructions. Unless relatively difficult mechanical jobs are undertaken frequently, it will not be economic to buy many of these tools. Where this is the case, you could consider clubbing together with friends (or joining a motorists' club) to make a joint purchase, or borrowing the tools against a deposit from a local garage or tool hire specialist. It is worth noting that many of the larger DIY superstores now carry a large range of special tools for hire at modest rates.

The following list contains only those tools and instruments freely available to the public, and not those special tools produced by the vehicle manufacturer specifically for its dealer network. You will find occasional references to these manufacturers' special tools in the text of this manual. Generally, an alternative method of doing the job without the vehicle manufacturers' special tool is given. However, sometimes there is no alternative to using them. Where this is the case and the relevant tool cannot be bought or borrowed, you will have to entrust the work to a dealer.

- Valve spring compressor
- Valve grinding tool
- Piston ring compressor
- Piston ring removal/installation tool
- Cylinder bore hone
- Balljoint separator
- Coil spring compressors (where applicable)
- Two/three-legged hub and bearing puller
- Impact screwdriver
- Micrometer and/or vernier calipers
- Dial gauge
- Stroboscopic timing light
- Dwell angle meter/tachometer
- Universal electrical multi-meter
- Cylinder compression gauge
- Hand-operated vacuum pump and gauge
- Clutch plate alignment set
- Brake shoe steady spring cup removal tool
- Bush and bearing removal/installation set
- Stud extractors
- Tap and die set
- Lifting tackle
- Trolley jack



Stroboscopic timing light

## Buying tools

Reputable motor accessory shops and superstores often offer excellent quality tools at discount prices, so it pays to shop around.

Remember, you don't have to buy the most expensive items on the shelf, but it is always advisable to steer clear of the very cheap tools. Beware of 'bargains' offered on market stalls or at car boot sales. There are plenty of good tools around at reasonable prices, but always aim to purchase items which meet the relevant national safety standards. If in doubt, ask the proprietor or manager of the shop for advice before making a purchase.

## Care and maintenance of tools

Having purchased a reasonable tool kit, it is necessary to keep the tools in a clean and serviceable condition. After use, always wipe off any dirt, grease and metal particles using a clean, dry cloth, before putting the tools away. Never leave them lying around after they have been used. A simple tool rack on the garage or workshop wall for items such as screwdrivers and pliers is a good idea. Store all normal spanners and sockets in a metal box. Any measuring instruments, gauges, meters, etc, must be carefully stored where they cannot be damaged or become rusty.

Take a little care when tools are used. Hammer heads inevitably become marked, and screwdrivers lose the keen edge on their blades from time to time. A little timely attention with emery cloth or a file will soon restore items like this to a good finish.



Micrometer set

## Working facilities

Not to be forgotten when discussing tools is the workshop itself. If anything more than routine maintenance is to be carried out, a suitable working area becomes essential.

It is appreciated that many an owner-mechanic is forced by circumstances to remove an engine or similar item without the benefit of a garage or workshop. Having done this, any repairs should always be done under the cover of a roof.

Wherever possible, any dismantling should be done on a clean, flat workbench or table at a suitable working height.

Any workbench needs a vice; one with a jaw opening of 100 mm is suitable for most jobs. As mentioned previously, some clean dry storage space is also required for tools, as well as for any lubricants, cleaning fluids, touch-up paints etc, which become necessary.

Another item which may be required, and which has a much more general usage, is an electric drill with a chuck capacity of at least 8 mm. This, together with a good range of twist drills, is virtually essential for fitting accessories.

Last, but not least, always keep a supply of old newspapers and clean, lint-free rags available, and try to keep any working area as clean as possible.



Dial test indicator ("dial gauge")



Compression tester



Stud extractor set

# REF•8 MOT test checks

This is a guide to getting your vehicle through the MOT test. Obviously it will not be possible to examine the vehicle to the same standard as the professional MOT tester. However, working through the following checks will enable you to identify any problem areas before submitting the vehicle for the test.

Where a testable component is in borderline condition, the tester has discretion in deciding whether to pass or fail it. The basis of such discretion is whether the tester would be happy for a close relative or friend to use the vehicle with the component in that condition. If the vehicle presented is clean and evidently well cared for, the tester may be more inclined to pass a borderline component than if the vehicle is scruffy and apparently neglected.

It has only been possible to summarise the test requirements here, based on the regulations in force at the time of printing. Test standards are becoming increasingly stringent, although there are some exemptions for older vehicles. For full details obtain a copy of the Haynes publication *Pass the MOT!* (available from stockists of Haynes manuals).

An assistant will be needed to help carry out some of these checks.



The checks have been sub-divided into four categories, as follows:

**1** Checks carried out **FROM THE DRIVER'S SEAT**

**2** Checks carried out **WITH THE VEHICLE ON THE GROUND**

**3** Checks carried out **WITH THE VEHICLE RAISED AND THE WHEELS FREE TO TURN**

**4** Checks carried out on **YOUR VEHICLE'S EXHAUST EMISSION SYSTEM**

**1** Checks carried out **FROM THE DRIVER'S SEAT**

## Handbrake

Test the operation of the handbrake. Excessive travel (too many clicks) indicates incorrect brake or cable adjustment.

Check that the handbrake cannot be released by tapping the lever sideways. Check the security of the lever mountings.



## Footbrake

Depress the brake pedal and check that it does not creep down to the floor, indicating a master cylinder fault. Release the pedal, wait a few seconds, then depress it again. If the pedal travels nearly to the floor before firm resistance is felt, brake adjustment or repair is necessary. If the pedal feels spongy, there is air in the hydraulic system which must be removed by bleeding.



Check that the brake pedal is secure and in good condition. Check also for signs of fluid leaks on the pedal, floor or carpets, which would indicate failed seals in the brake master cylinder.

Check the servo unit (when applicable) by operating the brake pedal several times, then keeping the pedal depressed and starting the engine. As the engine starts, the pedal will move down slightly. If not, the vacuum hose or the servo itself may be faulty.

## Steering wheel and column

Examine the steering wheel for fractures or looseness of the hub, spokes or rim.

Move the steering wheel from side to side and then up and down. Check that the steering wheel is not loose on the column, indicating wear or a loose retaining nut. Continue moving the steering wheel as before, but also turn it slightly from left to right.

Check that the steering wheel is not loose on the column, and that there is no abnormal



movement of the steering wheel, indicating wear in the column support bearings or couplings.

## Windscreen and mirrors

The windscreen must be free of cracks or other significant damage within the driver's field of view. (Small stone chips are acceptable.) Rear view mirrors must be secure, intact, and capable of being adjusted.







## Seat belts and seats

**Note:** The following checks are applicable to all seat belts, front and rear.

- Examine the webbing of all the belts (including rear belts if fitted) for cuts, serious fraying or deterioration. Fasten and unfasten each belt to check the buckles. If applicable, check the retracting mechanism. Check the security of all seat belt mountings accessible from inside the vehicle.
- The front seats themselves must be securely attached and the backrests must lock in the upright position.

## Doors

- Both front doors must be able to be opened and closed from outside and inside, and must latch securely when closed.

**2** Checks carried out WITH THE VEHICLE ON THE GROUND

## Vehicle identification

- Number plates must be in good condition, secure and legible, with letters and numbers correctly spaced – spacing at (A) should be twice that at (B).



- The VIN plate and/or homologation plate must be legible.

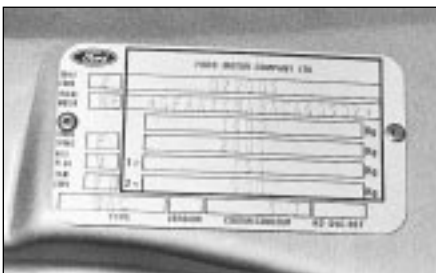

## Electrical equipment

- Switch on the ignition and check the operation of the horn.
- Check the windscreen washers and wipers, examining the wiper blades; renew damaged or perished blades. Also check the operation of the stop-lights.



- Check the operation of the sidelights and number plate lights. The lenses and reflectors must be secure, clean and undamaged.
- Check the operation and alignment of the headlights. The headlight reflectors must not be tarnished and the lenses must be undamaged.
- Switch on the ignition and check the operation of the direction indicators (including the instrument panel tell-tale) and the hazard warning lights. Operation of the sidelights and stop-lights must not affect the indicators - if it does, the cause is usually a bad earth at the rear light cluster.
- Check the operation of the rear foglight(s), including the warning light on the instrument panel or in the switch.

## Footbrake

- Examine the master cylinder, brake pipes and servo unit for leaks, loose mountings, corrosion or other damage.



- The fluid reservoir must be secure and the fluid level must be between the upper (A) and lower (B) markings.

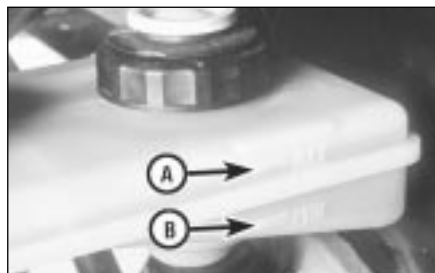

- Inspect both front brake flexible hoses for cracks or deterioration of the rubber. Turn the steering from lock to lock, and ensure that the hoses do not contact the wheel, tyre, or any part of the steering or suspension mechanism. With the brake pedal firmly depressed, check the hoses for bulges or leaks under pressure.



## Steering and suspension

- Have your assistant turn the steering wheel from side to side slightly, up to the point where the steering gear just begins to transmit this movement to the roadwheels. Check for excessive free play between the steering wheel and the steering gear, indicating wear or insecurity of the steering column joints, the column-to-steering gear coupling, or the steering gear itself.
- Have your assistant turn the steering wheel more vigorously in each direction, so that the roadwheels just begin to turn. As this is done, examine all the steering joints, linkages, fittings and attachments. Renew any component that shows signs of wear or damage. On vehicles with power steering, check the security and condition of the steering pump, drivebelt and hoses.
- Check that the vehicle is standing level, and at approximately the correct ride height.

## Shock absorbers

- Depress each corner of the vehicle in turn, then release it. The vehicle should rise and then settle in its normal position. If the vehicle continues to rise and fall, the shock absorber is defective. A shock absorber which has seized will also cause the vehicle to fail.



**Exhaust system**

□ Start the engine. With your assistant holding a rag over the tailpipe, check the entire system for leaks. Repair or renew leaking sections.

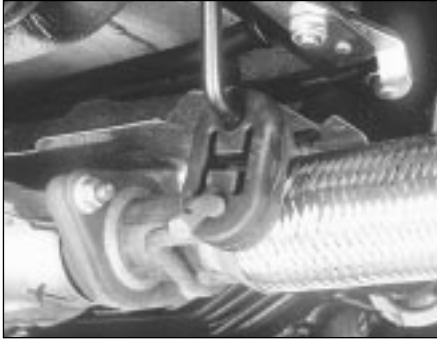

**3** Checks carried out **WITH THE VEHICLE RAISED AND THE WHEELS FREE TO TURN**

*Jack up the front and rear of the vehicle, and securely support it on axle stands. Position the stands clear of the suspension assemblies. Ensure that the wheels are clear of the ground and that the steering can be turned from lock to lock.*

**Steering mechanism**

□ Have your assistant turn the steering from lock to lock. Check that the steering turns smoothly, and that no part of the steering mechanism, including a wheel or tyre, fouls any brake hose or pipe or any part of the body structure.

□ Examine the steering rack rubber gaiters for damage or insecurity of the retaining clips. If power steering is fitted, check for signs of damage or leakage of the fluid hoses, pipes or connections. Also check for excessive stiffness or binding of the steering, a missing split pin or locking device, or severe corrosion of the body structure within 30 cm of any steering component attachment point.



**Front and rear suspension and wheel bearings**

□ Starting at the front right-hand side, grasp the roadwheel at the 3 o'clock and 9 o'clock positions and shake it vigorously. Check for free play or insecurity at the wheel bearings, suspension balljoints, or suspension mountings, pivots and attachments.

□ Now grasp the wheel at the 12 o'clock and 6 o'clock positions and repeat the previous inspection. Spin the wheel, and check for roughness or tightness of the front wheel bearing.



□ If excess free play is suspected at a component pivot point, this can be confirmed by using a large screwdriver or similar tool and levering between the mounting and the component attachment. This will confirm whether the wear is in the pivot bush, its retaining bolt, or in the mounting itself (the bolt holes can often become elongated).



□ Carry out all the above checks at the other front wheel, and then at both rear wheels.

**Springs and shock absorbers**

□ Examine the suspension struts (when applicable) for serious fluid leakage, corrosion, or damage to the casing. Also check the security of the mounting points.

□ If coil springs are fitted, check that the spring ends locate in their seats, and that the spring is not corroded, cracked or broken.

□ If leaf springs are fitted, check that all leaves are intact, that the axle is securely attached to each spring, and that there is no deterioration of the spring eye mountings, bushes, and shackles.

□ The same general checks apply to vehicles fitted with other suspension types, such as torsion bars, hydraulic displacer units, etc. Ensure that all mountings and attachments are secure, that there are no signs of excessive wear, corrosion or damage, and (on hydraulic types) that there are no fluid leaks or damaged pipes.

□ Inspect the shock absorbers for signs of serious fluid leakage. Check for wear of the mounting bushes or attachments, or damage to the body of the unit.

**Driveshafts (fwd vehicles only)**

□ Rotate each front wheel in turn and inspect the constant velocity joint gaiters for splits or damage. Also check that each driveshaft is straight and undamaged.



**Braking system**

□ If possible without dismantling, check brake pad wear and disc condition. Ensure that the friction lining material has not worn excessively, (A) and that the discs are not fractured, pitted, scored or badly worn (B).

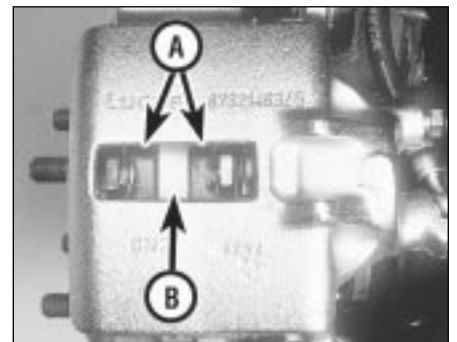

□ Examine all the rigid brake pipes underneath the vehicle, and the flexible hose(s) at the rear. Look for corrosion, chafing or insecurity of the pipes, and for signs of bulging under pressure, chafing, splits or deterioration of the flexible hoses.

□ Look for signs of fluid leaks at the brake calipers or on the brake backplates. Repair or renew leaking components.

□ Slowly spin each wheel, while your assistant depresses and releases the footbrake. Ensure that each brake is operating and does not bind when the pedal is released.



Examine the handbrake mechanism, checking for frayed or broken cables, excessive corrosion, or wear or insecurity of the linkage. Check that the mechanism works on each relevant wheel, and releases fully, without binding.

It is not possible to test brake efficiency without special equipment, but a road test can be carried out later to check that the vehicle pulls up in a straight line.

### Fuel and exhaust systems

Inspect the fuel tank (including the filler cap), fuel pipes, hoses and unions. All components must be secure and free from leaks.

Examine the exhaust system over its entire length, checking for any damaged, broken or missing mountings, security of the retaining clamps and rust or corrosion.



### Wheels and tyres

Examine the sidewalls and tread area of each tyre in turn. Check for cuts, tears, lumps, bulges, separation of the tread, and exposure of the ply or cord due to wear or damage. Check that the tyre bead is correctly seated on the wheel rim, that the valve is sound and

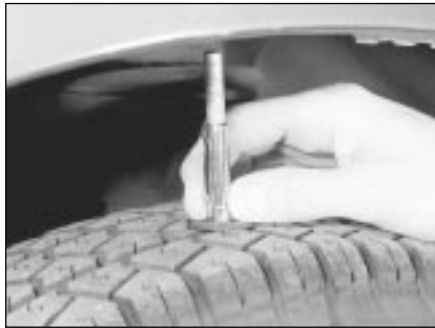

properly seated, and that the wheel is not distorted or damaged.

Check that the tyres are of the correct size for the vehicle, that they are of the same size and type on each axle, and that the pressures are correct.

Check the tyre tread depth. The legal minimum at the time of writing is 1.6 mm over at least three-quarters of the tread width. Abnormal tread wear may indicate incorrect front wheel alignment.

### Body corrosion

Check the condition of the entire vehicle structure for signs of corrosion in load-bearing areas. (These include chassis box sections, side sills, cross-members, pillars, and all suspension, steering, braking system and seat belt mountings and anchorages.) Any corrosion which has seriously reduced the thickness of a load-bearing area is likely to cause the vehicle to fail. In this case professional repairs are likely to be needed.

Damage or corrosion which causes sharp or otherwise dangerous edges to be exposed will also cause the vehicle to fail.

## 4 Checks carried out on YOUR VEHICLE'S EXHAUST EMISSION SYSTEM

### Petrol models

Have the engine at normal operating temperature, and make sure that it is in good tune (ignition system in good order, air filter element clean, etc).

Before any measurements are carried out, raise the engine speed to around 2500 rpm, and hold it at this speed for 20 seconds. Allow

the engine speed to return to idle, and watch for smoke emissions from the exhaust tailpipe. If the idle speed is obviously much too high, or if dense blue or clearly-visible black smoke comes from the tailpipe for more than 5 seconds, the vehicle will fail. As a rule of thumb, blue smoke signifies oil being burnt (engine wear) while black smoke signifies unburnt fuel (dirty air cleaner element, or other carburettor or fuel system fault).

An exhaust gas analyser capable of measuring carbon monoxide (CO) and hydrocarbons (HC) is now needed. If such an instrument cannot be hired or borrowed, a local garage may agree to perform the check for a small fee.

### CO emissions (mixture)

At the time of writing, the maximum CO level at idle is 3.5% for vehicles first used after August 1986 and 4.5% for older vehicles. From January 1996 a much tighter limit (around 0.5%) applies to catalyst-equipped vehicles first used from August 1992. If the CO level cannot be reduced far enough to pass the test (and the fuel and ignition systems are otherwise in good condition) then the carburettor is badly worn, or there is some problem in the fuel injection system or catalytic converter (as applicable).

### HC emissions

With the CO emissions within limits, HC emissions must be no more than 1200 ppm (parts per million). If the vehicle fails this test at idle, it can be re-tested at around 2000 rpm; if the HC level is then 1200 ppm or less, this counts as a pass.

Excessive HC emissions can be caused by oil being burnt, but they are more likely to be due to unburnt fuel.

### Diesel models

The only emission test applicable to Diesel engines is the measuring of exhaust smoke density. The test involves accelerating the engine several times to its maximum unloaded speed.

**Note:** *It is of the utmost importance that the engine timing belt is in good condition before the test is carried out.*

Excessive smoke can be caused by a dirty air cleaner element. Otherwise, professional advice may be needed to find the cause.

**Engine . . . . .1**

- Engine fails to rotate when attempting to start
- Engine rotates, but will not start
- Engine difficult to start when cold
- Engine difficult to start when hot
- Starter motor noisy or excessively-rough in engagement
- Engine starts, but stops immediately
- Engine idles erratically
- Engine misfires at idle speed
- Engine misfires throughout the driving speed range
- Engine hesitates on acceleration
- Engine stalls
- Engine lacks power
- Engine backfires
- Oil pressure warning light illuminated with engine running
- Engine runs-on after switching off
- Engine noises

**Cooling system . . . . .2**

- Overheating
- Overcooling
- External coolant leakage
- Internal coolant leakage
- Corrosion

**Fuel and exhaust systems . . . . .3**

- Excessive fuel consumption
- Fuel leakage and/or fuel odour
- Excessive noise or fumes from exhaust system

**Clutch . . . . .4**

- Pedal travels to floor - no pressure or very little resistance
- Clutch fails to disengage (unable to select gears)
- Clutch slips (engine speed increases, with no increase in vehicle speed)
- Judder as clutch is engaged
- Noise when depressing or releasing clutch pedal

**Manual gearbox . . . . .5**

- Noisy in neutral with engine running
- Noisy in one particular gear
- Difficulty engaging gears
- Jumps out of gear
- Vibration
- Lubricant leaks

**Automatic transmission . . . . .6**

- Fluid leakage
- Transmission fluid brown, or has burned smell
- General gear selection problems
- Transmission will not downshift (kickdown) with accelerator fully depressed

**Automatic transmission (continued)**

- Engine will not start in any gear, or starts in gears other than Park or Neutral
- Transmission slips, shifts roughly, is noisy, or has no drive in forward or reverse gears

**Driveshafts . . . . .7**

- Clicking or knocking noise on turns (at slow speed on full-lock)
- Vibration when accelerating or decelerating

**Hydraulic system . . . . .8**

- Loss of hydraulic pressure
- Loss of suspension pressure
- Loss of brake pressure

**Braking system . . . . .9**

- Vehicle pulls to one side under braking
- Noise (grinding or high-pitched squeal) when brakes applied
- Excessive brake pedal travel
- Brake pedal feels spongy when depressed
- Excessive brake pedal effort required to stop vehicle
- Judder felt through brake pedal or steering wheel when braking
- Brakes binding

**Suspension and steering . . . . .10**

- Vehicle pulls to one side
- Wheel wobble and vibration
- Excessive pitching and/or rolling around corners, or during braking
- Wandering or general instability
- Excessively-stiff steering
- Tyre wear excessive

**Electrical system . . . . .11**

- Battery will only hold a charge for a few days
- Ignition/no-charge warning light remains illuminated with engine running
- Ignition/no-charge warning light fails to come on
- Lights inoperative
- Instrument readings inaccurate or erratic
- Horn inoperative, or unsatisfactory in operation
- Windscreen/tailgate wipers inoperative, or unsatisfactory in operation
- Windscreen/tailgate washers inoperative, or unsatisfactory in operation
- Electric windows inoperative, or unsatisfactory in operation
- Central locking inoperative, or unsatisfactory in operation

**Introduction**

The vehicle owner who does his or her own maintenance according to the recommended service schedules should not have to use this section of the manual very often. Modern component reliability is such that, provided those items subject to wear or deterioration are inspected or renewed at the specified intervals, sudden failure is comparatively rare. Faults do not usually just happen as a result of sudden failure, but develop over a period of time. Major mechanical failures in particular are usually preceded by characteristic symptoms

over hundreds or even thousands of miles. Those components which do occasionally fail without warning are often small and easily carried in the vehicle.

With any fault finding, the first step is to decide where to begin investigations. Sometimes this is obvious, but on other occasions a little detective work will be necessary. The owner who makes half a dozen haphazard adjustments or replacements may be successful in curing a fault (or its symptoms), but will be none the wiser if the fault

recurs and ultimately may have spent more time and money than was necessary. A calm and logical approach will be found to be more satisfactory in the long run. Always take into account any warning signs or abnormalities that may have been noticed in the period preceding the fault - power loss, high or low gauge readings, unusual smells, etc - and remember that failure of components such as fuses or spark plugs may only be pointers to some underlying fault.

The pages which follow provide an easy reference guide to the more common problems which may occur during the operation of the vehicle. These problems and their possible causes are grouped under headings denoting various components or systems, such as Engine, Cooling system, etc. The Chapter and/or Section which deals with the problem is also shown in brackets. Whatever the fault, certain basic principles apply. These are as follows:

*Verify the fault.* This is simply a matter of being sure that you know what the symptoms are before starting work. This is particularly important if you are investigating a fault for someone else who may not have described it very accurately.

*Don't overlook the obvious.* For example, if the vehicle won't start, is there petrol in the tank? (Don't take anyone else's word on this particular point, and don't trust the fuel gauge either!) If an electrical fault is indicated, look for loose or broken wires before digging out the test gear.

*Cure the disease, not the symptom.* Substituting a flat battery with a fully charged one will get you off the hard shoulder, but if the underlying cause is not attended to, the new battery will go the same way. Similarly, changing oil-fouled spark plugs for a new set will get you moving again, but remember that the reason for the fouling (if it wasn't simply an incorrect grade of plug) will have to be established and corrected.

*Don't take anything for granted.* Particularly, don't forget that a 'new' component may itself be defective (especially if it's been rattling around in the boot for months), and don't leave components out of a fault diagnosis sequence just because they are new or recently fitted. When you do finally diagnose a difficult fault, you'll probably realise that all the evidence was there from the start.

## 1 Engine

### **Engine fails to rotate when attempting to start**

- Battery terminal connections loose or corroded (*Weekly checks*).
- Battery discharged or faulty (Chapter 5).
- Broken, loose or disconnected wiring in the starting circuit (Chapter 5).
- Defective starter solenoid or switch (Chapter 5).
- Defective starter motor (Chapter 5).
- Starter pinion or flywheel ring gear teeth loose or broken (Chapters 2 and 5).
- Engine earth strap broken or disconnected (Chapter 5).

### **Engine rotates but will not start**

- Fuel tank empty.
- Battery discharged (engine rotates slowly) (Chapter 5).
- Battery terminal connections loose or corroded (*Weekly checks*).
- Ignition components damp or damaged (Chapters 1 and 5).
- Broken, loose or disconnected wiring in the ignition circuit (Chapters 1 and 5).
- Worn, faulty or incorrectly gapped spark plugs (Chapter 1).
- Choke mechanism sticking, incorrectly adjusted, or faulty (Chapter 4).
- Major mechanical failure (eg camshaft drive) (Chapter 2).

### **Engine difficult to start when cold**

- Battery discharged (Chapter 5).
- Battery terminal connections loose or corroded (*Weekly checks*).
- Worn, faulty or incorrectly gapped spark plugs (Chapter 1).
- Choke mechanism sticking, incorrectly adjusted, or faulty (Chapter 4).
- Other ignition system fault (Chapters 1 and 5).
- Low cylinder compressions (Chapter 2).

### **Engine difficult to start when hot**

- Air filter element dirty or clogged (Chapter 1).
- Choke mechanism sticking, incorrectly adjusted, or faulty (Chapter 4).
- Carburettor float chamber flooding (Chapter 4).
- Low cylinder compressions (Chapter 2).

### **Starter motor noisy or excessively rough in engagement**

- Starter pinion or flywheel ring gear teeth loose or broken (Chapters 2 and 5).
- Starter motor mounting bolts loose or missing (Chapter 5).
- Starter motor internal components worn or damaged (Chapter 5).

### **Engine starts but stops immediately**

- Insufficient fuel reaching carburettor (Chapter 4).
- Loose or faulty electrical connections in the ignition circuit (Chapters 1 and 5).
- Vacuum leak at the carburettor or inlet manifold (Chapter 4).
- Blocked carburettor jet(s) or internal passages (Chapter 4).

### **Engine idles erratically**

- Incorrectly adjusted idle speed and/or mixture settings (Chapters 1 and 4).
- Air filter element clogged (Chapter 1).
- Vacuum leak at the carburettor, inlet manifold or associated hoses (Chapter 4).
- Worn, faulty or incorrectly gapped spark plugs (Chapter 1).
- Uneven or low cylinder compressions (Chapter 2).
- Camshaft lobes worn (Chapter 2).
- Timing belt incorrectly tensioned (Chapter 2).

### **Engine misfires at idle speed**

- Worn, faulty or incorrectly gapped spark plugs (Chapter 1).
- Faulty spark plug HT leads (Chapters 1 and 5).
- Incorrectly adjusted idle mixture settings (Chapter 1).
- Incorrect ignition timing (Chapter 5).
- Vacuum leak at the carburettor, inlet manifold or associated hoses (Chapter 4).
- Distributor cap cracked or tracking internally (Chapter 5).
- Uneven or low cylinder compressions (Chapter 2).
- Disconnected, leaking or perished crankcase ventilation hoses (Chapters 1 and 4).

### **Engine misfires throughout the driving speed range**

- Blocked carburettor jet(s) or internal passages (Chapter 4).
- Carburettor worn or incorrectly adjusted (Chapters 1 and 4).
- Fuel filter choked (Chapter 1).
- Fuel pump faulty or delivery pressure low (Chapter 4).
- Fuel tank vent blocked or fuel pipes restricted (Chapter 4).
- Vacuum leak at the carburettor, inlet manifold or associated hoses (Chapter 4).
- Worn, faulty or incorrectly gapped spark plugs (Chapter 1).
- Faulty spark plug HT leads (Chapter 5).
- Distributor cap cracked or tracking internally (Chapter 5).
- Faulty ignition coil (Chapter 5).
- Uneven or low cylinder compressions (Chapter 2).

## 1 Engine (continued)

### **Engine hesitates on acceleration**

- Worn, faulty or incorrectly gapped spark plugs (Chapter 1).
- Carburettor accelerator pump faulty (Chapter 4).
- Blocked carburettor jets or internal passages (Chapter 4).
- Vacuum leak at the carburettor, inlet manifold or associated hoses (Chapter 4).
- Carburettor worn or incorrectly adjusted (Chapters 1 and 4).

### **Engine stalls**

- Incorrectly adjusted idle speed and/or mixture settings (Chapters 1 and 4).
- Blocked carburettor jet(s) or internal passages (Chapter 4).
- Vacuum leak at the carburettor, inlet manifold or associated hoses (Chapter 4).
- Fuel filter choked (Chapter 1).
- Fuel pump faulty or delivery pressure low (Chapter 4).
- Fuel tank vent blocked or fuel pipes restricted (Chapter 4).

### **Engine lacks power**

- Incorrect ignition timing (Chapter 5).
- Carburettor worn or incorrectly adjusted (Chapter 1).
- Timing belt incorrectly fitted or tensioned (Chapter 2).
- Fuel filter choked (Chapter 1).
- Fuel pump faulty or delivery pressure low (Chapter 4).
- Uneven or low cylinder compressions (Chapter 2).
- Worn, faulty or incorrectly gapped spark plugs (Chapter 1).
- Vacuum leak at the carburettor, inlet manifold or associated hoses (Chapter 4).
- Brakes binding (Chapters 1 and 10).
- Clutch slipping (Chapter 6).

### **Engine backfires**

- Ignition timing incorrect (Chapter 5).
- Timing belt incorrectly fitted or tensioned (Chapter 2).
- Carburettor worn or incorrectly adjusted (Chapters 1 and 4).
- Vacuum leak at the carburettor, inlet manifold or associated hoses (Chapter 4).

### **Oil pressure warning light illuminated with engine running**

- Low oil level or incorrect grade ("Weekly checks").
- Faulty oil pressure switch (Chapter 2).
- Worn engine bearings and/or oil pump (Chapter 2).

- High engine operating temperature (Chapter 3).
- Oil pressure relief valve defective (Chapter 2).
- Oil pick-up strainer clogged (Chapter 2).

### **Engine runs-on after switching off**

- Idle speed excessively high (Chapter 1).
- Faulty anti-run-on solenoid (Chapter 4).
- Excessive carbon build-up in engine (Chapter 2).
- High engine operating temperature (Chapter 3).

### **Engine noises**

#### **Pre-ignition (pink) or knocking during acceleration or under load**

- Ignition timing incorrect (Chapter 5).
- Incorrect grade of fuel (Chapter 4).
- Vacuum leak at the carburettor, inlet manifold or associated hoses (Chapter 4).
- Excessive carbon build-up in engine (Chapter 2).
- Worn or damaged distributor or other ignition system component (Chapter 5).
- Carburettor worn or incorrectly adjusted (Chapter 1).

#### **Whistling or wheezing noises**

- Leaking inlet manifold or carburettor gasket (Chapter 4).
- Leaking exhaust manifold gasket or pipe to manifold joint (Chapter 4).
- Leaking vacuum hose (Chapter 4).
- Blowing cylinder head gasket (Chapter 2).

#### **Tapping or rattling noises**

- Wrong valve clearances (Chapter 1).
- Worn valve gear or camshaft (Chapter 2).
- Worn timing belt or tensioner (Chapter 2).
- Ancillary component fault (coolant pump, alternator, etc) (Chapters 3 and 5).

#### **Knocking or thumping noises**

- Worn big-end bearings (regular heavy knocking, perhaps less under load) (Chapter 2).
- Worn main bearings (rumbling and knocking, perhaps worsening under load) (Chapter 2).
- Piston slap (most noticeable when cold) (Chapter 2).
- Ancillary component fault (alternator, coolant pump, etc) (Chapters 3 and 5).

## 2 Cooling system

### **Overheating**

- Insufficient coolant in system (Chapter 3).
- Thermostat faulty (Chapter 3).
- Radiator core blocked or grille restricted (Chapter 3).
- Electric cooling fan or thermostatic switch faulty (Chapter 3).
- Pressure cap faulty (Chapter 3).
- Timing belt worn, or incorrectly tensioned (Chapter 2).
- Ignition timing incorrect (Chapter 5).
- Inaccurate temperature gauge sender unit (Chapter 3).
- Air lock in cooling system (Chapter 3).

### **Overcooling**

- Thermostat faulty (Chapter 3).
- Inaccurate temperature gauge sender unit (Chapter 3).

### **External coolant leakage**

- Deteriorated or damaged hoses or hose clips (Chapter 1).
- Radiator core or heater matrix leaking (Chapter 3).
- Pressure cap faulty (Chapter 3).
- Coolant pump seal leaking (Chapter 3).
- Boiling due to overheating (Chapter 3).
- Core plug leaking (Chapter 2).

### **Internal coolant leakage**

- Leaking cylinder head gasket (Chapter 2).
- Cracked cylinder head or cylinder bore (Chapter 2).

### **Corrosion**

- Infrequent draining and flushing (Chapter 1).
- Incorrect antifreeze mixture or inappropriate type ("Weekly checks").

## 3 Fuel and exhaust systems

### Excessive fuel consumption

- Air filter element dirty or clogged (Chapter 1).
- Carburettor worn or incorrectly adjusted (Chapters 1 and 4).
- Choke cable incorrectly adjusted or sticking (Chapter 4).
- Ignition timing incorrect (Chapter 5).
- Tyres under inflated (*Weekly checks*).

### Fuel leakage and/or fuel odour

- Damaged or corroded fuel tank, pipes or connections (Chapter 1).
- Carburettor float chamber flooding (Chapter 4).

### Excessive noise or fumes from exhaust system

- Leaking exhaust system or manifold joints (Chapter 1).
- Leaking, corroded or damaged silencers or pipe (Chapter 1).
- Broken mountings causing body or suspension contact (Chapter 1).

## 4 Clutch

### Pedal travels to floor - no pressure or very little resistance

- Broken clutch cable (Chapter 6).
- Faulty clutch pedal adjust mechanism (Chapter 6).
- Broken clutch release bearing or fork (Chapter 6).
- Broken diaphragm spring in clutch pressure plate (Chapter 6).

### Clutch fails to disengage (unable to select gears)

- Faulty clutch pedal adjust mechanism (Chapter 6).
- Clutch friction plate sticking on transmission input shaft splines (Chapter 6).
- Clutch friction plate sticking to flywheel or pressure plate (Chapter 6).
- Faulty pressure plate assembly (Chapter 6).
- Transmission input shaft seized in crankshaft spigot bearing (Chapter 2).
- Clutch release mechanism worn or incorrectly assembled (Chapter 6).

### Clutch slips (engine speed increases with no increase in vehicle speed)

- Faulty clutch pedal adjust mechanism (Chapter 6).

- Clutch friction plate friction material excessively worn (Chapter 6).
- Clutch friction plate friction material contaminated with oil or grease (Chapter 6).
- Faulty pressure plate or weak diaphragm spring (Chapter 6).

### Judder as clutch is engaged

- Clutch friction plate friction material contaminated with oil or grease (Chapter 6).
- Clutch friction plate friction material excessively worn (Chapter 6).
- Clutch cable sticking or frayed (Chapter 6).
- Faulty or distorted pressure plate or diaphragm spring (Chapter 6).
- Worn or loose engine or gearbox mountings (Chapter 2).
- Clutch friction plate hub or transmission input shaft splines worn (Chapter 6).

### Noise when depressing or releasing clutch pedal

- Worn clutch release bearing (Chapter 6).
- Worn or dry clutch pedal bushes (Chapter 6).
- Faulty pressure plate assembly (Chapter 6).
- Pressure plate diaphragm spring broken (Chapter 6).
- Broken clutch friction plate cushioning springs (Chapter 6).

## 5 Manual gearbox

### Noisy in neutral with engine running

- Input shaft bearings worn (noise apparent with clutch pedal released but not when depressed) (Chapter 7).\*
- Clutch release bearing worn (noise apparent with clutch pedal depressed, possibly less when released) (Chapter 6).

### Noisy in one particular gear

- Worn, damaged or chipped gear teeth (Chapter 7).\*

### Difficulty engaging gears

- Clutch fault (Chapter 6).
- Worn or damaged gear linkage (Chapter 7).
- Incorrectly adjusted gear linkage (Chapter 7).
- Worn synchroniser units (Chapter 7).\*

### Jumps out of gear

- Worn or damaged gear linkage (Chapter 7).

- Incorrectly adjusted gear linkage (Chapter 7).
- Worn synchroniser units (Chapter 7).\*
- Worn selector forks (Chapter 7).\*

### Vibration

- Lack of oil (Chapter 1).
- Worn bearings (Chapter 7).\*

### Lubricant leaks

- Leaking driveshaft oil seal (Chapter 7).
- Leaking housing joint (Chapter 7).\*
- Leaking input shaft oil seal (Chapter 7).\*

*\*Although the corrective action necessary to remedy the symptoms described is beyond the scope of the home mechanic, the above information should be helpful in isolating the cause of the condition so that the owner can communicate clearly with a professional mechanic*

## 6 Automatic transmission

**Note:** Due to the complexity of the automatic transmission, it is difficult for the home mechanic to properly diagnose and service this unit. For problems other than the following, the vehicle should be taken to a dealer service department or automatic transmission specialist.

### Fluid leakage

- Automatic transmission fluid is usually deep red in colour. Fluid leaks should not be confused with engine oil, which can easily be blown onto the transmission by air flow.

## 6 Automatic transmission (continued)

- To determine the source of a leak, first remove all built-up dirt and grime from the transmission housing and surrounding areas, using a degreasing agent or by steam-cleaning. Drive the vehicle at low speed, so that air flow will not blow the leak far from its source. Raise and support the vehicle, and determine where the leak is coming from. The following are common areas of leakage:
  - a) Fluid pan (transmission sump).
  - b) Dipstick tube (Chapter 7).
  - c) Transmission-to-fluid cooler fluid pipes/unions (Chapter 7).

### Transmission fluid brown, or has burned smell

- Transmission fluid level low, or fluid in need of renewal (Chapter 1).

### General gear selection problems

- The most likely cause of gear selection problems is a faulty or poorly-adjusted gear selector mechanism. The following are common problems associated with a faulty selector mechanism:
  - a) Engine starting in gears other than Park or Neutral.
  - b) Indicator on gear selector lever pointing to a gear other than the one actually being used.
  - c) Vehicle moves when in Park or Neutral.
  - d) Poor gear shift quality, or erratic gear changes.
- Refer any problems to a Citroen dealer, or an automatic transmission specialist.

### Transmission will not downshift (kickdown) with accelerator pedal fully depressed

- Low transmission fluid level (Chapter 1).
- Incorrect selector adjustment (Chapter 7).

### Engine will not start in any gear, or starts in gears other than Park or Neutral

- Faulty starter inhibitor switch (Chapter 7).
- Incorrect selector adjustment (Chapter 7).

### Transmission slips, shifts roughly, is noisy, or has no drive in forward or reverse gears

- There are many probable causes for the above problems, but the home mechanic should be concerned with only one possibility - fluid level. Before taking the vehicle to a dealer or transmission specialist, check the fluid level and condition of the fluid as described in Chapter 1. Correct the fluid level as necessary, or change the fluid and filter if needed. If the problem persists, professional help will be necessary.

## 7 Driveshafts

### Clicking or knocking noise on turns (at slow speed on full lock)

- Lack of constant velocity joint lubricant (Chapter 8).
- Worn outer constant velocity joint (Chapter 8).

### Vibration when accelerating or decelerating

- Worn inner constant velocity joint (Chapter 8).
- Bent or distorted driveshaft (Chapter 8).

## 8 Hydraulic system

### Loss of hydraulic pressure

- Reservoir filters blocked (Chapter 9).
- Pump supply pipe leaking (Chapter 9).
- Pressure regulator faulty (Chapter 9).
- Pump faulty or drivebelt broken (Chapter 9).
- Pressure regulator bleed screw loose (Chapter 9).

### Excessive hydraulic pressure

- Pressure regulator faulty (Chapter 9).

### Loss of suspension pressure

- Safety valve faulty (Chapter 9).
- Height corrector faulty (Chapter 9).
- Suspension cylinders faulty (Chapter 9).
- Height adjustment incorrect (see Chapters 9 and 11)

### Loss of brake pressure

- Brake valve faulty (see Chapters 9 and 10)

## 9 Braking system

**Note:** Before assuming that a brake problem exists, make sure that the tyres are in good condition and correctly inflated, the front wheel alignment is correct and the vehicle is not loaded with weight in an unequal manner

### Vehicle pulls to one side under braking

- Worn, defective, damaged or contaminated front or rear brake pads on one side (Chapter 1).
- Seized or partially seized front or rear brake caliper piston (Chapter 10).
- A mixture of brake pad materials fitted between sides (Chapter 1).
- Brake caliper mounting bolts loose (Chapter 10).
- Worn or damaged steering or suspension components (Chapter 11).

### Noise (grinding or high-pitched squeal) when brakes applied

- Brake pad friction material worn down to metal backing (Chapter 1).
- Excessive corrosion of brake disc, especially if the vehicle has been standing for some time (Chapter 1).
- Foreign object (stone chipping etc) trapped between brake disc and splash shield (Chapter 1).

### Excessive brake pedal travel

- Air in hydraulic system (Chapters 9 and 10).

### Brake pedal feels spongy when depressed

- Air in hydraulic system (Chapters 9 and 10).
- Deteriorated flexible rubber brake hoses (Chapters 1 or 10).



## 9 Braking system (continued)

### **Excessive brake pedal effort required to stop vehicle**

- Hydraulic circuit failure (Chapters 9 and 10).
- Seized brake caliper piston(s) (Chapter 10).
- Brake pads incorrectly fitted (Chapter 1).
- Incorrect grade of brake pads fitted (Chapter 1).
- Brake pads contaminated (Chapter 1).

### **Judder felt through brake pedal or steering wheel when braking**

- Excessive run-out or distortion of discs (Chapter 10).
- Brake pads worn (Chapter 1).
- Brake caliper mounting bolts loose (Chapter 10).
- Wear in suspension, steering components or mountings (Chapter 11).

### **Brakes binding**

- Seized brake caliper piston(s) (Chapter 10).
- Incorrectly adjusted handbrake mechanism (Chapter 10).

## 10 Suspension and steering

**Note:** Before diagnosing suspension or steering faults, be sure that the trouble is not due to incorrect tyre pressures, mixtures of tyre types or binding brakes

### **Vehicle pulls to one side**

- Defective tyre (*Weekly checks*).
- Excessive wear in suspension or steering components (Chapter 11).
- Incorrect front wheel alignment (Chapter 11).
- Accident damage to steering or suspension components (Chapter 11).

### **Wheel wobble and vibration**

- Front roadwheels out of balance (vibration felt mainly through the steering wheel) (Chapter 11).
- Rear roadwheels out of balance (vibration felt throughout the vehicle) (Chapter 11).
- Roadwheels damaged or distorted (Chapter 11).
- Faulty or damaged tyre (*Weekly checks*).
- Worn steering or suspension joints, bushes or components (Chapter 11).
- Wheel nuts loose (Chapter 1).

### **Excessive pitching and/or rolling around corners or during braking**

- Defective damping units (Chapter 11).
- Broken or weak suspension component (Chapter 11).
- Worn or damaged anti-roll bar or mountings (Chapter 11).

### **Wandering or general instability**

- Incorrect front wheel alignment (Chapter 11).
- Worn steering or suspension joints, bushes or components (Chapter 11).
- Roadwheels out of balance (Chapter 11).
- Faulty or damaged tyre (*Weekly checks*).
- Wheel nuts loose (Chapter 1).
- Defective damping units (Chapter 11).

### **Excessively stiff steering**

- Lack of steering gear lubricant (Chapter 11).
- Seized track rod balljoint or suspension balljoint (Chapter 11).
- Incorrect front wheel alignment (Chapter 11).
- Steering rack or column bent or damaged (Chapter 11).

### **Excessive play in steering**

- Worn steering column universal joint(s) or intermediate coupling (Chapter 11).
- Worn steering track rod balljoints (Chapter 11).
- Worn steering gear (Chapter 11).
- Worn steering or suspension joints, bushes or components (Chapter 11).

### **Tyre wear excessive**

#### **Tyres worn on inside or outside edges**

- Tyres under inflated (wear on both edges) (*Weekly checks*).
- Incorrect camber or castor angles (wear on one edge only) (Chapter 11).
- Worn steering or suspension joints, bushes or components (Chapter 11).
- Excessively hard cornering.
- Accident damage.

#### **Tyre treads exhibit feathered edges**

- Incorrect toe setting (Chapter 11).

#### **Tyres worn in centre of tread**

- Tyres over inflated (*Weekly checks*).

#### **Tyres worn on inside and outside edges**

- Tyres under inflated (*Weekly checks*).

#### **Tyres worn unevenly**

- Tyres out of balance (*Weekly checks*).
- Excessive wheel or tyre run-out (*Weekly checks*).
- Defective damping units (Chapter 11).
- Faulty tyre (*Weekly checks*).

## 11 Electrical system

**Note:** For problems associated with the starting system, refer to the faults listed under "Engine" earlier in this Section

### **Battery will only hold a charge for a few days**

- Battery defective internally (Chapter 5).
- Battery electrolyte level low (*Weekly checks*).
- Battery terminal connections loose or corroded (*Weekly checks*).
- Alternator drivebelt worn or incorrectly adjusted (Chapter 1).
- Alternator not charging at correct output (Chapter 5).

- Alternator or voltage regulator faulty (Chapter 5).
- Short-circuit causing continual battery drain (Chapter 5).

### **Ignition warning light remains illuminated with engine running**

- Alternator drivebelt broken, worn, or incorrectly adjusted (Chapter 1).
- Alternator brushes worn, sticking, or dirty (Chapter 5).
- Alternator brush springs weak or broken (Chapter 5).
- Internal fault in alternator (Chapter 5).
- Broken, disconnected, or loose wiring in charging circuit (Chapter 5).

## 11 Electrical system (continued)

### **Ignition warning light fails to come on**

- Warning light bulb blown (Chapter 13).
- Broken, disconnected, or loose wiring in warning light circuit (Chapter 13).
- Alternator faulty (Chapter 5).

### **Lights inoperative**

- Bulb blown (Chapter 13).
- Corrosion of bulb or bulbholder contacts (Chapter 13).
- Blown fuse (Chapter 13).
- Faulty relay (Chapter 13).
- Broken, loose, or disconnected wiring (Chapter 13).
- Faulty switch (Chapter 13).

### **Instrument readings inaccurate or erratic**

#### **Fuel or temperature gauge give no reading**

- Faulty sender unit (Chapters 3 or 4).
- Wiring open circuit (Chapter 13).
- Faulty gauge (Chapter 13).

#### **Fuel or temperature gauges give continuous maximum reading**

- Faulty sender unit (Chapters 3 or 4).
- Wiring short-circuit (Chapter 13).
- Faulty gauge (Chapter 13).

### **Horn inoperative or unsatisfactory in operation**

#### **Horn operates all the time**

- Horn push either earthed or stuck down (Chapter 13).
- Horn cable to horn push earthed (Chapter 13).

#### **Horn fails to operate**

- Blown fuse (Chapter 13).
- Cable or cable connections loose, broken or disconnected (Chapter 13).
- Faulty horn (Chapter 13).

#### **Horn emits intermittent or unsatisfactory sound**

- Cable connections loose (Chapter 13).
- Horn mountings loose (Chapter 13).
- Faulty horn (Chapter 13).

### **Windscreen/tailgate wipers inoperative or unsatisfactory in operation**

#### **Wipers fail to operate or operate very slowly**

- Wiper blades stuck to screen, or linkage seized or binding (Chapter 13).
- Blown fuse (Chapter 13).
- Cable or cable connections loose, broken or disconnected (Chapter 13).
- Faulty relay (Chapter 13).
- Faulty wiper motor (Chapter 13).

#### **Wiper blades sweep over too large or too small an area of the glass**

- Wiper arms incorrectly positioned on spindles (Chapter 13).
- Excessive wear of wiper linkage (Chapter 13).
- Wiper motor or linkage mountings loose or insecure (Chapter 13).

### **Wiper blades fail to clean the glass effectively**

- Wiper blade rubbers worn or perished (*Weekly checks*).
- Wiper arm tension springs broken or arm pivots seized (Chapter 13).
- Insufficient windscreen washer additive to adequately remove road dirt film (*Weekly checks*).

### **Windscreen/tailgate washers inoperative or unsatisfactory in operation**

#### **One or more washer jets inoperative**

- Blocked washer jet (Chapter 13).
- Disconnected, kinked or restricted fluid hose (Chapter 13).
- Insufficient fluid in washer reservoir (*Weekly checks*).

#### **Washer pump fails to operate**

- Broken or disconnected wiring or connections (Chapter 13).
- Blown fuse (Chapter 13).
- Faulty washer switch (Chapter 13).
- Faulty washer pump (Chapter 13).

#### **Washer pump runs for some time before fluid is emitted from jets**

- Faulty one-way valve in fluid supply hose (Chapter 13).

### **Electric windows inoperative or unsatisfactory in operation**

#### **Window glass will only move in one direction**

- Faulty switch (Chapter 13).

#### **Window glass slow to move**

- Incorrectly adjusted door glass guide channels (Chapter 12).
- Regulator seized or damaged, or in need of lubrication (Chapter 12).
- Door internal components or trim fouling regulator (Chapter 12).
- Faulty motor (Chapter 13).

#### **Window glass fails to move**

- Incorrectly adjusted door glass guide channels (Chapter 12).
- Blown fuse (Chapter 13).
- Faulty relay (Chapter 13).
- Broken or disconnected wiring or connections (Chapter 13).
- Faulty motor (Chapter 13).

### **Central locking system inoperative or unsatisfactory in operation**

#### **Complete system failure**

- Blown fuse (Chapter 13).
- Faulty relay (Chapter 13).
- Broken or disconnected wiring or connections (Chapter 13).

#### **Latch locks but will not unlock, or unlocks but will not lock**

- Faulty master switch (Chapter 13).
- Broken or disconnected latch operating rods or levers (Chapter 12).
- Faulty relay (Chapter 13).

#### **One motor fails to operate**

- Broken or disconnected wiring or connections (Chapter 13).
- Faulty motor (Chapter 13).
- Broken, binding or disconnected latch operating rods or levers (Chapter 12).
- Fault in door latch (Chapter 12).

## A

**ABS (Anti-lock brake system)** A system, usually electronically controlled, that senses incipient wheel lockup during braking and relieves hydraulic pressure at wheels that are about to skid.

**Air bag** An inflatable bag hidden in the steering wheel (driver's side) or the dash or glovebox (passenger side). In a head-on collision, the bags inflate, preventing the driver and front passenger from being thrown forward into the steering wheel or windscreen.

**Air cleaner** A metal or plastic housing, containing a filter element, which removes dust and dirt from the air being drawn into the engine.

**Air filter element** The actual filter in an air cleaner system, usually manufactured from pleated paper and requiring renewal at regular intervals.

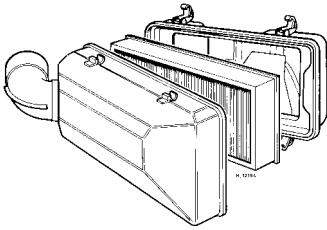

*Air filter*

**Allen key** A hexagonal wrench which fits into a recessed hexagonal hole.

**Alligator clip** A long-nosed spring-loaded metal clip with meshing teeth. Used to make temporary electrical connections.

**Alternator** A component in the electrical system which converts mechanical energy from a drivebelt into electrical energy to charge the battery and to operate the starting system, ignition system and electrical accessories.

**Ampere (amp)** A unit of measurement for the flow of electric current. One amp is the amount of current produced by one volt acting through a resistance of one ohm.

**Anaerobic sealer** A substance used to prevent bolts and screws from loosening. Anaerobic means that it does not require oxygen for activation. The Loctite brand is widely used.

**Antifreeze** A substance (usually ethylene glycol) mixed with water, and added to a vehicle's cooling system, to prevent freezing of the coolant in winter. Antifreeze also contains chemicals to inhibit corrosion and the formation of rust and other deposits that would tend to clog the radiator and coolant passages and reduce cooling efficiency.

**Anti-seize compound** A coating that reduces the risk of seizing on fasteners that are subjected to high temperatures, such as exhaust manifold bolts and nuts.

**Asbestos** A natural fibrous mineral with great heat resistance, commonly used in the composition of brake friction materials.

Asbestos is a health hazard and the dust created by brake systems should never be inhaled or ingested.

**Axle** A shaft on which a wheel revolves, or which revolves with a wheel. Also, a solid beam that connects the two wheels at one end of the vehicle. An axle which also transmits power to the wheels is known as a live axle.

**Axleshaft** A single rotating shaft, on either side of the differential, which delivers power from the final drive assembly to the drive wheels. Also called a driveshaft or a halfshaft.

## B

**Ball bearing** An anti-friction bearing consisting of a hardened inner and outer race with hardened steel balls between two races.

**Bearing** The curved surface on a shaft or in a bore, or the part assembled into either, that permits relative motion between them with minimum wear and friction.



*Bearing*

**Big-end bearing** The bearing in the end of the connecting rod that's attached to the crankshaft.

**Bleed nipple** A valve on a brake wheel cylinder, caliper or other hydraulic component that is opened to purge the hydraulic system of air. Also called a bleed screw.

**Brake bleeding** Procedure for removing air from lines of a hydraulic brake system.

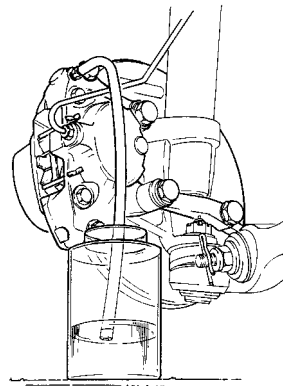

*Brake bleeding*

**Brake disc** The component of a disc brake that rotates with the wheels.

**Brake drum** The component of a drum brake that rotates with the wheels.

**Brake linings** The friction material which contacts the brake disc or drum to retard the vehicle's speed. The linings are bonded or riveted to the brake pads or shoes.

**Brake pads** The replaceable friction pads that pinch the brake disc when the brakes are applied. Brake pads consist of a friction material bonded or riveted to a rigid backing plate.

**Brake shoe** The crescent-shaped carrier to which the brake linings are mounted and which forces the lining against the rotating drum during braking.

**Braking systems** For more information on braking systems, consult the *Haynes Automotive Brake Manual*.

**Breaker bar** A long socket wrench handle providing greater leverage.

**Bulkhead** The insulated partition between the engine and the passenger compartment.

## C

**Caliper** The non-rotating part of a disc-brake assembly that straddles the disc and carries the brake pads. The caliper also contains the hydraulic components that cause the pads to pinch the disc when the brakes are applied. A caliper is also a measuring tool that can be set to measure inside or outside dimensions of an object.

**Camshaft** A rotating shaft on which a series of cam lobes operate the valve mechanisms. The camshaft may be driven by gears, by sprockets and chain or by sprockets and a belt.

**Canister** A container in an evaporative emission control system; contains activated charcoal granules to trap vapours from the fuel system.



*Canister*

**Carburettor** A device which mixes fuel with air in the proper proportions to provide a desired power output from a spark ignition internal combustion engine.

**Castellated** Resembling the parapets along the top of a castle wall. For example, a castellated balljoint stud nut.

**Castor** In wheel alignment, the backward or forward tilt of the steering axis. Castor is positive when the steering axis is inclined rearward at the top.

**Catalytic converter** A silencer-like device in the exhaust system which converts certain pollutants in the exhaust gases into less harmful substances.

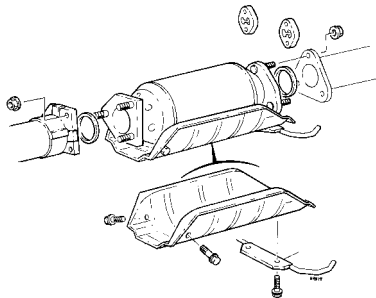

*Catalytic converter*

**Circlip** A ring-shaped clip used to prevent endwise movement of cylindrical parts and shafts. An internal circlip is installed in a groove in a housing; an external circlip fits into a groove on the outside of a cylindrical piece such as a shaft.

**Clearance** The amount of space between two parts. For example, between a piston and a cylinder, between a bearing and a journal, etc.

**Coil spring** A spiral of elastic steel found in various sizes throughout a vehicle, for example as a springing medium in the suspension and in the valve train.

**Compression** Reduction in volume, and increase in pressure and temperature, of a gas, caused by squeezing it into a smaller space.

**Compression ratio** The relationship between cylinder volume when the piston is at top dead centre and cylinder volume when the piston is at bottom dead centre.

**Constant velocity (CV) joint** A type of universal joint that cancels out vibrations caused by driving power being transmitted through an angle.

**Core plug** A disc or cup-shaped metal device inserted in a hole in a casting through which core was removed when the casting was formed. Also known as a freeze plug or expansion plug.

**Crankcase** The lower part of the engine block in which the crankshaft rotates.

**Crankshaft** The main rotating member, or shaft, running the length of the crankcase, with offset "throws" to which the connecting rods are attached.

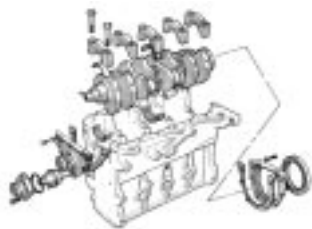

*Crankshaft assembly*

**Crocodile clip** See Alligator clip

## D

**Diagnostic code** Code numbers obtained by accessing the diagnostic mode of an engine management computer. This code can be used to determine the area in the system where a malfunction may be located.

**Disc brake** A brake design incorporating a rotating disc onto which brake pads are squeezed. The resulting friction converts the energy of a moving vehicle into heat.

**Double-overhead cam (DOHC)** An engine that uses two overhead camshafts, usually one for the intake valves and one for the exhaust valves.

**Drivebelt(s)** The belt(s) used to drive accessories such as the alternator, water pump, power steering pump, air conditioning compressor, etc. off the crankshaft pulley.

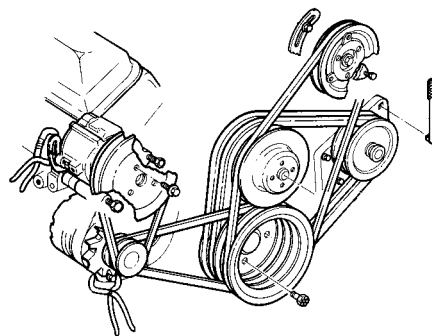

*Accessory drivebelts*

**Driveshaft** Any shaft used to transmit motion. Commonly used when referring to the axleshafts on a front wheel drive vehicle.

**Drum brake** A type of brake using a drum-shaped metal cylinder attached to the inner surface of the wheel. When the brake pedal is pressed, curved brake shoes with friction linings press against the inside of the drum to slow or stop the vehicle.

## E

**EGR valve** A valve used to introduce exhaust gases into the intake air stream.

**Electronic control unit (ECU)** A computer which controls (for instance) ignition and fuel injection systems, or an anti-lock braking system. For more information refer to the *Haynes Automotive Electrical and Electronic Systems Manual*.

**Electronic Fuel Injection (EFI)** A computer controlled fuel system that distributes fuel through an injector located in each intake port of the engine.

**Emergency brake** A braking system, independent of the main hydraulic system, that can be used to slow or stop the vehicle if the primary brakes fail, or to hold the vehicle stationary even though the brake pedal isn't depressed. It usually consists of a hand lever that actuates either front or rear brakes mechanically through a series of cables and linkages. Also known as a handbrake or parking brake.

**Endfloat** The amount of lengthwise movement between two parts. As applied to a crankshaft, the distance that the crankshaft can move forward and back in the cylinder block.

**Engine management system (EMS)** A computer controlled system which manages the fuel injection and the ignition systems in an integrated fashion.

**Exhaust manifold** A part with several passages through which exhaust gases leave the engine combustion chambers and enter the exhaust pipe.

## F

**Fan clutch** A viscous (fluid) drive coupling device which permits variable engine fan speeds in relation to engine speeds.

**Feeler blade** A thin strip or blade of hardened steel, ground to an exact thickness, used to check or measure clearances between parts.



*Feeler blade*

**Firing order** The order in which the engine cylinders fire, or deliver their power strokes, beginning with the number one cylinder.

**Flywheel** A heavy spinning wheel in which energy is absorbed and stored by means of momentum. On cars, the flywheel is attached to the crankshaft to smooth out firing impulses.

**Free play** The amount of travel before any action takes place. The "looseness" in a linkage, or an assembly of parts, between the initial application of force and actual movement. For example, the distance the brake pedal moves before the pistons in the master cylinder are actuated.

**Fuse** An electrical device which protects a circuit against accidental overload. The typical fuse contains a soft piece of metal which is calibrated to melt at a predetermined current flow (expressed as amps) and break the circuit.

**Fusible link** A circuit protection device consisting of a conductor surrounded by heat-resistant insulation. The conductor is smaller than the wire it protects, so it acts as the weakest link in the circuit. Unlike a blown fuse, a failed fusible link must frequently be cut from the wire for replacement.

## G

**Gap** The distance the spark must travel in jumping from the centre electrode to the side electrode in a spark plug. Also refers to the spacing between the points in a contact breaker assembly in a conventional points-type ignition, or to the distance between the reluctor or rotor and the pickup coil in an electronic ignition.



*Adjusting spark plug gap*

**Gasket** Any thin, soft material - usually cork, cardboard, asbestos or soft metal - installed between two metal surfaces to ensure a good seal. For instance, the cylinder head gasket seals the joint between the block and the cylinder head.

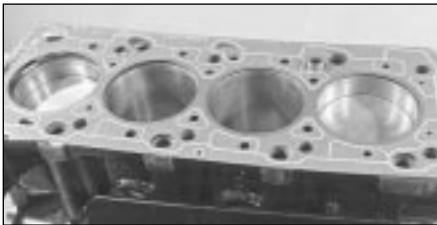

*Gasket*

**Gauge** An instrument panel display used to monitor engine conditions. A gauge with a movable pointer on a dial or a fixed scale is an analogue gauge. A gauge with a numerical readout is called a digital gauge.

## H

**Halfshaft** A rotating shaft that transmits power from the final drive unit to a drive wheel, usually when referring to a live rear axle.

**Harmonic balancer** A device designed to reduce torsion or twisting vibration in the crankshaft. May be incorporated in the crankshaft pulley. Also known as a vibration damper.

**Hone** An abrasive tool for correcting small irregularities or differences in diameter in an engine cylinder, brake cylinder, etc.

**Hydraulic tappet** A tappet that utilises hydraulic pressure from the engine's lubrication system to maintain zero clearance (constant contact with both camshaft and valve stem). Automatically adjusts to variation in valve stem length. Hydraulic tappets also reduce valve noise.

## I

**Ignition timing** The moment at which the spark plug fires, usually expressed in the number of crankshaft degrees before the piston reaches the top of its stroke.

**Inlet manifold** A tube or housing with passages through which flows the air-fuel mixture (carburettor vehicles and vehicles with throttle body injection) or air only (port fuel-injected vehicles) to the port openings in the cylinder head.

## J

**Jump start** Starting the engine of a vehicle with a discharged or weak battery by attaching jump leads from the weak battery to a charged or helper battery.

## L

**Load Sensing Proportioning Valve (LSPV)** A brake hydraulic system control valve that works like a proportioning valve, but also takes into consideration the amount of weight carried by the rear axle.

**Locknut** A nut used to lock an adjustment nut, or other threaded component, in place. For example, a locknut is employed to keep the adjusting nut on the rocker arm in position.

**Lockwasher** A form of washer designed to prevent an attaching nut from working loose.

## M

**MacPherson strut** A type of front suspension system devised by Earle MacPherson at Ford of England. In its original form, a simple lateral link with the anti-roll bar creates the lower control arm. A long strut - an integral coil spring and shock absorber - is mounted between the body and the steering knuckle. Many modern so-called MacPherson strut systems use a conventional lower A-arm and don't rely on the anti-roll bar for location.

**Multimeter** An electrical test instrument with the capability to measure voltage, current and resistance.

## N

**NOx** Oxides of Nitrogen. A common toxic pollutant emitted by petrol and diesel engines at higher temperatures.

## O

**Ohm** The unit of electrical resistance. One volt applied to a resistance of one ohm will produce a current of one amp.

**Ohmmeter** An instrument for measuring electrical resistance.

**O-ring** A type of sealing ring made of a special rubber-like material; in use, the O-ring is compressed into a groove to provide the sealing action.

**Overhead cam (ohc) engine** An engine with the camshaft(s) located on top of the cylinder head(s).

**Overhead valve (ohv) engine** An engine with the valves located in the cylinder head, but with the camshaft located in the engine block.

**Oxygen sensor** A device installed in the engine exhaust manifold, which senses the oxygen content in the exhaust and converts this information into an electric current. Also called a Lambda sensor.

## P

**Phillips screw** A type of screw head having a cross instead of a slot for a corresponding type of screwdriver.

**Plastigage** A thin strip of plastic thread, available in different sizes, used for measuring clearances. For example, a strip of Plastigage is laid across a bearing journal. The parts are assembled and dismantled; the width of the crushed strip indicates the clearance between journal and bearing.



*Plastigage*

**Propeller shaft** The long hollow tube with universal joints at both ends that carries power from the transmission to the differential on front-engined rear wheel drive vehicles.

**Proportioning valve** A hydraulic control valve which limits the amount of pressure to the rear brakes during panic stops to prevent wheel lock-up.

## R

**Rack-and-pinion steering** A steering system with a pinion gear on the end of the steering shaft that mates with a rack (think of a geared wheel opened up and laid flat). When the steering wheel is turned, the pinion turns, moving the rack to the left or right. This movement is transmitted through the track rods to the steering arms at the wheels.

**Radiator** A liquid-to-air heat transfer device designed to reduce the temperature of the coolant in an internal combustion engine cooling system.

**Refrigerant** Any substance used as a heat transfer agent in an air-conditioning system. R-12 has been the principle refrigerant for many years; recently, however, manufacturers have begun using R-134a, a non-CFC substance that is considered less harmful to the ozone in the upper atmosphere.

**Rocker arm** A lever arm that rocks on a shaft or pivots on a stud. In an overhead valve engine, the rocker arm converts the upward movement of the pushrod into a downward movement to open a valve.

**Rotor** In a distributor, the rotating device inside the cap that connects the centre electrode and the outer terminals as it turns, distributing the high voltage from the coil secondary winding to the proper spark plug. Also, that part of an alternator which rotates inside the stator. Also, the rotating assembly of a turbocharger, including the compressor wheel, shaft and turbine wheel.

**Runout** The amount of wobble (in-and-out movement) of a gear or wheel as it's rotated. The amount a shaft rotates "out-of-true." The out-of-round condition of a rotating part.

## S

**Sealant** A liquid or paste used to prevent leakage at a joint. Sometimes used in conjunction with a gasket.

**Sealed beam lamp** An older headlight design which integrates the reflector, lens and filaments into a hermetically-sealed one-piece unit. When a filament burns out or the lens cracks, the entire unit is simply replaced.

**Serpentine drivebelt** A single, long, wide accessory drivebelt that's used on some newer vehicles to drive all the accessories, instead of a series of smaller, shorter belts. Serpentine drivebelts are usually tensioned by an automatic tensioner.

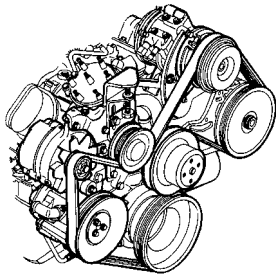

*Serpentine drivebelt*

**Shim** Thin spacer, commonly used to adjust the clearance or relative positions between two parts. For example, shims inserted into or under bucket tappets control valve clearances. Clearance is adjusted by changing the thickness of the shim.

**Slide hammer** A special puller that screws into or hooks onto a component such as a shaft or bearing; a heavy sliding handle on the shaft bottoms against the end of the shaft to knock the component free.

**Sprocket** A tooth or projection on the periphery of a wheel, shaped to engage with a chain or drivebelt. Commonly used to refer to the sprocket wheel itself.

**Starter inhibitor switch** On vehicles with an automatic transmission, a switch that prevents starting if the vehicle is not in Neutral or Park.

**Strut** See MacPherson strut.

## T

**Tappet** A cylindrical component which transmits motion from the cam to the valve stem, either directly or via a pushrod and rocker arm. Also called a cam follower.

**Thermostat** A heat-controlled valve that regulates the flow of coolant between the cylinder block and the radiator, so maintaining optimum engine operating temperature. A thermostat is also used in some air cleaners in which the temperature is regulated.

**Thrust bearing** The bearing in the clutch assembly that is moved in to the release levers by clutch pedal action to disengage the clutch. Also referred to as a release bearing.

**Timing belt** A toothed belt which drives the camshaft. Serious engine damage may result if it breaks in service.

**Timing chain** A chain which drives the camshaft.

**Toe-in** The amount the front wheels are closer together at the front than at the rear. On rear wheel drive vehicles, a slight amount of toe-in is usually specified to keep the front wheels running parallel on the road by offsetting other forces that tend to spread the wheels apart.

**Toe-out** The amount the front wheels are closer together at the rear than at the front. On front wheel drive vehicles, a slight amount of toe-out is usually specified.

**Tools** For full information on choosing and using tools, refer to the *Haynes Automotive Tools Manual*.

**Tracer** A stripe of a second colour applied to a wire insulator to distinguish that wire from another one with the same colour insulator.

**Tune-up** A process of accurate and careful adjustments and parts replacement to obtain the best possible engine performance.

**Turbocharger** A centrifugal device, driven by exhaust gases, that pressurises the intake air. Normally used to increase the power output from a given engine displacement, but can also be used primarily to reduce exhaust emissions (as on VW's "Umwelt" Diesel engine).

## U

**Universal joint or U-joint** A double-pivoted connection for transmitting power from a driving to a driven shaft through an angle. A U-joint consists of two Y-shaped yokes and a cross-shaped member called the spider.

## V

**Valve** A device through which the flow of liquid, gas, vacuum, or loose material in bulk may be started, stopped, or regulated by a movable part that opens, shuts, or partially obstructs one or more ports or passageways. A valve is also the movable part of such a device.

**Valve clearance** The clearance between the valve tip (the end of the valve stem) and the rocker arm or tappet. The valve clearance is measured when the valve is closed.

**Vernier caliper** A precision measuring instrument that measures inside and outside dimensions. Not quite as accurate as a micrometer, but more convenient.

**Viscosity** The thickness of a liquid or its resistance to flow.

**Volt** A unit for expressing electrical "pressure" in a circuit. One volt that will produce a current of one ampere through a resistance of one ohm.

## W

**Welding** Various processes used to join metal items by heating the areas to be joined to a molten state and fusing them together. For more information refer to the *Haynes Automotive Welding Manual*.

**Wiring diagram** A drawing portraying the components and wires in a vehicle's electrical system, using standardised symbols. For more information refer to the *Haynes Automotive Electrical and Electronic Systems Manual*.

**Note:** References throughout this index are in the form - "Chapter number" • "page number"

## A

**ABS** - 10•9  
**Accelerator cable** - 4A•21, 4B•5, 4C•4, 4D•4  
**Air cleaner** - 1•18, 4A•6  
**Air conditioning system** - 3•11  
**Airflow meter** - 4C•3  
**Alternator drivebelt** - 1•14, 5C•3  
**Alternator** - 5C•3  
**Anti-roll bar** - 11•7, 11•11  
**Antifreeze** - 0•11, 0•16, 1•19  
**ATF** - 0•16, 1•11, 1•21  
**Automatic transmission - 7B•1 et seq**  
 fault finding - REF•12, REF•15  
 fluid - 0•16, 1•11, 1•21  
 kickdown cable - 7B•2  
 overhaul - 7B•4  
 removal and refitting - 7B•4  
 selector control - 7B•2

## B

**Battery:**  
 booster - 0•7  
 charging - 5C•2  
 checks - 0•6, 0•14  
 removal and refitting - 5C•2  
**Bleeding the brakes** - 10•11  
**Body electrical systems - 13•1 et seq**  
**Bodywork and fittings - 12•1 et seq**  
**Bonnet lock** - 12•4  
**Bonnet removal, refitting and adjustment** - 12•4  
**Brake light switch** - 10•11  
**Braking system - 10•1 et seq**  
 ABS control unit - 10•9  
 ABS hydraulic control block - 10•9  
 ABS wheel sensor - 10•9  
 brake disc check - 1•13  
 brake discs removal and refitting - 10•5  
 brake pad check - 1•11  
 brake pads renewal - 10•2  
 brake pedal - 10•10  
 checks - 1•9  
 compensator control valve - 10•8  
 fault finding - REF•12, REF•16  
 fluid - 0•12, 0•16  
 front caliper unit - 10•5  
 handbrake cable - 10•10  
 handbrake check - 1•13  
 handbrake warning switch - 13•10  
 rear caliper unit - 10•7  
**Bulbs** - 13•3, 13•4, 13•5, 13•6  
**Bumpers removal and refitting** - 12•9

## C

**Cables:**  
 accelerator - 4A•21, 4B•5, 4C•4, 4D•4  
 choke - 4A•21  
 clutch - 1•17, 6•2  
 handbrake - 10•10  
 kickdown - 7B•2  
 speedometer - 13•11  
**Calipers** - 10•5, 10•7  
**Camshaft drivebelt** - 1•19, 2B•6, 2B•19, 2C•2, 2C•11  
**Camshaft** - 2B•9, 2C•11  
**Camshaft/rocker gear** - 2A•13  
**Camshaft/tappets** - 2B•15  
**Carburettors - 4A•9 et seq**  
**Carpets and upholstery** - 12•2  
**Central locking** - 13•13  
**Choke cable** - 4A•21  
**Cigar lighter** - 13•10  
**Clock** - 13•11  
**Clutch - 6•1 et seq**  
 cable - 1•17, 6•2  
 check - 1•11  
 fault finding - REF•12, REF•15  
 inspection and repair - 6•4  
 pedal - 1•17  
 release mechanism - 6•5  
 removal and refitting - 6•3  
 transfer gears - 6•6  
**Coil** - 5A•3, 5B•3  
**Console** - 12•11  
**Contents** - 0•2  
**Conversion factors** - REF•2  
**Cooling, heating and air conditioning systems - 3•1 et seq**  
 coolant pump - 3•5  
 coolant - 0•11, 0•16, 1•19  
 coolant low level warning switch - 3•4  
 coolant temperature switch - 3•4  
 draining - 1•19  
 fan - 3•3  
 fan thermal switch - 3•4  
 fault finding - REF•12, REF•14  
 filling - 1•21  
 flushing - 1•20  
 heater unit - 3•6, 3•8  
 heater matrix - 3•10  
 heater blower motor - 3•9  
 heater control panel - 3•10  
 radiator - 3•3  
 thermostat - 3•4  
**Crankshaft oil seals** - 2C•13, 2C•14

**Crankshaft/main bearings** - 2A•11, 2A•18, 2B•15, 2B•17  
**Cylinder head** - 2A•4, 2A•14, 2B•9, 2B•15, 2B•19, 2C•4, 2C•11, 2D•3  
**Cylinder liners** - 2A•16

## D

**Dashboard** - 12•11  
**Dents** - 12•2  
**Diagnostic test socket** - 5A•5  
**Dimensions and weights** - REF•1  
**Distributor cap** - 5A•4, 5B•4  
**Distributor** - 5A•4, 5B•4  
**Door trim** - 12•6  
**Door lock and handles** - 12•7  
**Door courtesy/boot light switch** - 13•9  
**Doors removal and refitting** - 12•8  
**Drivebelts:**  
 alternator - 5C•3  
 camshaft - 2B•6, 2B•19, 2C•2, 2C•11  
 checks - 1•14, 1•19  
 timing - 2B•15  
**Driveshafts - 8•1 et seq**  
 and differential oil seals - 7A•5  
 bellows - 1•13, 8•1  
 fault finding - REF•12, REF•16  
 HP pump - 1•14  
 intermediate bearing - 8•4  
 removal and refitting - 8•2, 8•3

## E

**ECU** - 5B•4  
**Electric window regulator** - 13•13  
**Electrical system checks** - 0•14  
**Electrical system fault finding** - REF•12, REF•17  
**Electronic control unit** - 5B•4  
**Emission control system** - 4D•6  
**Engine 150 - 2A•1 et seq**  
**Engine 171 and 159 - 2B•1 et seq**  
**Engine K1G - 2C•1 et seq**  
**Engine D6C - 2D•1 et seq**  
 camshaft drivebelt - 1•19, 2B•6, 2B•19, 2C•2, 2C•11  
 camshaft - 2B•9, 2C•11  
 camshaft and rocker gear - 2A•13  
 camshaft/tappets - 2B•15  
 crankshaft and main bearings - 2A•11, 2A•18, 2B•15, 2B•17  
 crankshaft oil seals - 2C•13, 2C•14  
 cylinder head - 2A•4, 2A•14, 2B•9, 2B•15, 2B•19, 2C•4, 2C•11, 2D•3

cylinder liners - 2A•16  
dismantling - 2A•8, 2B•13, 2C•9, 2D•6  
fault finding - REF•12, REF•13  
oil - 0•11, 0•16, 1•10  
oil filter - 1•10  
oil pump - 2A•14, 2A•20, 2B•15, 2B•18, 2C•13  
pistons - 2A•12, 2A•17, 2C•13  
reassembly - 2A•16, 2B•16, 2C•12, 2D•8  
timing chain - 2A•12, 2A•19  
timing belt - 2B•15, 2D•2  
valve rocker clearances - 2A•4  
**Engine management system** - 5B•5  
**Engine/transmission removal and refitting** - 2A•6, 2B•12, 2B•21, 2C•7, 2D•6, 2D•12  
**Exhaust manifold** - 4A•22, 4B•5, 4D•5  
**Exhaust system checks** - 1•10  
**Exhaust emission control system** - 4D•6  
**Exhaust maintenance, removal and refitting** - 4A•22, 4B•6, 4C•4

## F

**Fault finding - REF•12**  
automatic transmission - REF•12, REF•15  
braking system - REF•12, REF•16  
clutch - REF•12, REF•15  
cooling system - REF•12, REF•14  
driveshafts - REF•12, REF•16  
electrical system - REF•12, REF•17  
engine - REF•12, REF•13  
fuel and exhaust system - REF•12, REF•15  
manual gearbox - REF•12, REF•15  
hydraulic system - REF•12, REF•16  
suspension and steering - REF•12, REF•17  
**Filters :**  
air cleaner - 1•18  
fuel - 1•17, 1•21, 4A•8  
hydraulic system - 1•19  
oil - 1•10  
**Fluids** - 0•16  
**Foglight switches** - 13•10  
**Foglights** - 13•4  
**Fuel and exhaust systems - carburettor models - 4A•1 et seq**  
**Fuel and exhaust systems - Bosch LE3 Jetronic system - 4B•1 et seq**  
**Fuel and exhaust systems - Motronic injection - 4C•1 et seq**  
**Fuel and exhaust systems - Magneti Marelli injection - 4D•1 et seq**  
accelerator cable - 4A•21, 4B•5, 4C•4, 4D•4  
air cleaner - 1•18, 4A•6

air intake - 4A•7  
airflow meter - 4C•3  
carburettors - 4A•9 et seq  
choke cable - 4A•21  
de-aeration reservoir - 4B•4  
depressurisation - 4B•3  
emission control system - 4D•6  
exhaust maintenance, removal and refitting - 4A•22, 4B•6, 4C•4  
fault finding - REF•12, REF•15  
fuel filter - 1•17, 1•21, 4A•8  
fuel injectors - 4B•5, 4D•4  
fuel level transmitter - 4A•8  
fuel pressure regulator - 4D•5  
fuel pump - 4A•7, 4B•3  
fuel tank - 4A•8, 4B•4  
idle control stepper motor - 4D•5  
idle speed/mixture adjustment - 1•16, 4A•10, 4B•4, 4C•4, 4D•3  
inlet and exhaust manifolds - 4A•22, 4B•5, 4D•5  
Solex carburettors - 4A•12 et seq  
throttle body - 4D•4  
throttle initial position - 4B•4  
throttle position switch - 4B•4  
throttle potentiometer - 4D•5  
Weber carburettors - 4A•17 et seq  
**Fuses** - 13•1, 13•2, 13•3

## G

**Gearbox :**  
ATF - 0•16, 1•11, 1•21  
oil - 0•16, 1•22  
**General repair procedures** - REF•4  
**Glass** - 12•5, 12•7, 12•11  
**Glossary of technical terms** - REF•19  
**Glovebox light** - 13•6

## H

**Handbrake:**  
cable - 10•10  
check - 1•13  
warning switch - 13•10  
**Headlight alignment** - 13•6  
**Headlights** - 13•4  
**Heated window element** - 13•12  
**Heater unit** - 3•6, 3•8  
**Heater matrix** - 3•10  
**Heater blower motor** - 3•9  
**Heater control panel** - 3•10  
**Horn** - 13•6

**HT leads** - 5A•3  
**Hydraulic system - 9•1 et seq**  
checks - 1•10  
fault finding - REF•12, REF•16  
filter - 1•19  
fluid - 0•12, 0•16  
high-pressure pump - 9•5  
pipes - 9•3  
pressure checks - 9•3  
pressure regulator unit - 9•4  
security valve - 9•5  
system bleeding - 10•11

## I

**Idle speed/mixture adjustment** - 1•16, 4A•10, 4B•4, 4C•4, 4D•3  
**Ignition system - carburettor models - 5A•1 et seq**  
**Ignition system - fuel injection models - 5B•1 et seq**  
coil - 5A•3, 5B•3  
switch and steering lock - 5A•6  
timing - 5A•5  
**Indicators** - 13•4  
**Injectors** - 4B•5, 4D•4  
**Inlet manifold** - 4A•22, 4B•5, 4D•5  
**Instrument panel lights** - 13•6  
**Instrument panel removal and refitting** - 13•6  
**Instrument panel switches** - 13•8  
**Interior light** - 13•5  
**Introduction** - 0•4

## J

**Jacking and vehicle support** - REF•5  
**Jump starting** - 0•7

## K

**Kickdown cable** - 7B•2

## L

**Leaks** - 0•9, 1•9  
**Lights interior** - 13•5 et seq  
**Lights exterior** - 13•4 et seq  
**Locks bonnet** - 12•4  
**Locks door** - 12•7  
**Locking system** - 13•13  
**Lubricants, fluids and capacities** - 0•16  
**Luggage compartment light** - 13•6



## M

**Maintenance schedule** - 1•4  
**Manifolds** - 4A•22, 4B•5, 4D•5  
**Manual gearbox - 7A•1 et seq**  
 differential/driveshaft oil seals - 7A•5  
 fault finding - REF•12, REF•15  
 gearchange linkage - 7A•3  
 oil - 0•16, 1•22  
 overhaul - 7A•5  
 removal and refitting - 7A•4  
**Mirror switches** - 13•10  
**Mirrors** - 12•5  
**Mixture adjustment/idle speed** - 1•16, 4A•10, 4B•4, 4C•4, 4D•3  
**MOT test checks** - REF•8

## N

**Number plate light** - 13•5

## O

**Oils:**  
 engine - 0•11, 0•16, 1•10  
 gearbox - 0•16, 1•22  
**Oil filter** - 1•10  
**Oil pump** - 2A•14, 2A•20, 2B•15, 2B•18, 2C•13  
**Oil seals crankshaft** - 2C•13  
**Oil seals differential/driveshaft** - 7A•5

## P

**Parts** - REF•3  
**Pedals clutch** - 1•17  
**Pedals brake** - 10•10  
**Pistons** - 2A•12, 2A•17, 2C•13  
**Power steering** - 11•17  
**Power steering fluid** - 0•12, 0•16

## R

**Radiator** - 3•3  
**Radio/cassette** - 13•14  
**Rear lights** - 13•5  
**Relays** - 13•3  
**Remote locking system** - 13•13  
**Respraying** - 12•2  
**Routine maintenance and servicing - 1•1 et seq**  
**Rust** - 12•2

## S

**Safety first!** - 0•5  
**Screen washer fluid** - 0•12  
**Seat belts** - 1•9, 1•14  
**Seat (estate rear)** - 12•12  
**Sensors (Motronic)** - 5B•5  
**Sensors (Magnetic Marelli)** - 5B•5  
**Sidelights** - 13•5  
**Solex carburettors** - 4A•12 et seq  
**Spark plugs** - 1•17, 5A•3, 5B•3  
**Speakers** - 13•14  
**Specifications** - see start of each chapter  
**Speedometer cable** - 13•11  
**Starter motor** - 5C•3  
**Starting problems** - 0•6  
**Starting and charging systems - 5C•1 et seq**  
**Steering - 11•1 et seq**  
 checks - 1•13  
 column housing - 11•16  
 column switches - 13•8  
 fault finding - REF•12, REF•17  
 front wheel hub bearings - 11•3  
 lock/ignition switch - 11•16, 5A•6  
 manual steering gear unit - 11•16  
 power steering gear unit - 11•17  
 rear wheel bearings - 11•9  
 swivel - 11•13  
 track rod/balljoint - 11•13  
 wheel alignment - 11•18  
 wheel - 11•14  
**Sunroof motor** - 13•14  
**Sunroof** - 12•10  
**Suspension - 11•1 et seq**  
 anti-roll bar - 11•7, 11•11  
 checks - 1•18  
 fault finding - REF•12, REF•17  
 front arm - 11•4  
 height correctors - 11•12  
 hydraulic - 11•7, 11•11  
 rear arm - 11•10  
 subframe - 11•6  
**Switches:**  
 brake light - 10•11  
 coolant low level warning - 3•4  
 coolant temperature switch - 3•4  
 cooling fan thermal - 3•4  
 door and boot light - 13•9  
 foglight - 13•10  
 handbrake warning - 13•10  
 ignition - 5A•6  
 instrument panel - 13•8

mirror - 13•10  
 steering column - 13•8  
 throttle position - 4B•4  
 window - 13•10

## T

**Tailgate removal and refitting** - 12•8  
**TDC sensor (Motronic)** - 5B•5  
**Thermostat** - 3•4  
**Throttle cable** - 4A•21, 4B•5, 4C•4, 4D•4  
**Timing chain** - 2A•12, 2A•19  
**Timing belt** - 2B•15, 2D•2  
**Timing** - 5A•5  
**Tools** - REF•6  
**Towing** - 0•9  
**Transfer gears** - 6•6  
**Tyre condition** - 0•13  
**Tyre pressures** - 0•15

## U

**Underbody views** - 1•7, 1•8  
**Underbonnet views** - 0•10, 1•5, 1•6, 1•7  
**Upholstery and carpets** - 12•2

## V

**Valve clearances** - 1•14, 1•15  
**Valve rocker clearances** - 2A•4  
**Vehicle identification** - REF•3

## W

**Weber carburettors** - 4A•17 et seq  
**Weights and dimensions** - REF•1  
**Wheel alignment** - 11•18  
**Wheel changing** - 0•8  
**Window channels** - 12•7  
**Window regulator** - 12•7  
**Window switches** - 13•10  
**Windows electric regulator** - 13•13  
**Windscreen** - 12•11  
**Windscreen washer units** - 13•12  
**Wings** - 12•4  
**Wiper arms** - 13•11  
**Wiper motors** - 13•12  
**Wiper blades** - 0•15, 13•11  
**Wiring diagrams** - 13•15 et seq

# Preserving Our Motoring Heritage



<  
The Model J Duesenberg Derham Tourster. Only eight of these magnificent cars were ever built – this is the only example to be found outside the United States of America

Almost every car you've ever loved, loathed or desired is gathered under one roof at the Haynes Motor Museum. Over 300 immaculately presented cars and motorbikes represent every aspect of our motoring heritage, from elegant reminders of bygone days, such as the superb Model J Duesenberg to curiosities like the bug-eyed BMW Isetta. There are also many old friends and flames. Perhaps you remember the 1959 Ford Popular that you did your courting in? The magnificent 'Red Collection' is a spectacle of classic sports cars including AC, Alfa Romeo, Austin Healey, Ferrari, Lamborghini, Maserati, MG, Riley, Porsche and Triumph.

## A Perfect Day Out

Each and every vehicle at the Haynes Motor Museum has played its part in the history and culture of Motoring. Today, they make a wonderful spectacle and a great day out for all the family. Bring the kids, bring Mum and Dad, but above all bring your camera to capture those golden memories for ever. You will also find an impressive array of motoring memorabilia, a comfortable 70 seat video cinema and one of the most extensive transport book shops in Britain. The Pit Stop Cafe serves everything from a cup of tea to wholesome, home-made meals or, if you prefer, you can enjoy the large picnic area nestled in the beautiful rural surroundings of Somerset.



>  
John Haynes O.B.E.,  
Founder and  
Chairman of the  
museum at the wheel  
of a Haynes Light 12.



<  
Graham Hill's Lola  
Cosworth Formula 1  
car next to a 1934  
Riley Sports.

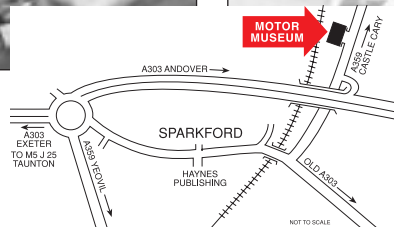

The Museum is situated on the A359 Yeovil to Frome road at Sparkford, just off the A303 in Somerset. It is about 40 miles south of Bristol, and 25 minutes drive from the M5 intersection at Taunton.

Open 9.30am - 5.30pm (10.00am - 4.00pm Winter) 7 days a week, except Christmas Day, Boxing Day and New Years Day  
Special rates available for schools, coach parties and outings Charitable Trust No. 292048