

# CORTECO 21653150

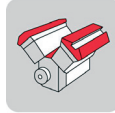

<b>Citroen</b>		
Berlingo	DW8B DW10TD	air condition / 09154 ->
<b>Fiat</b>		
Ducato	RHV	
Scudo	RHX RHZ	Code: C6367 Code: C6367
Ulysse	RHW RHZ 4HW	
<b>Lancia</b>		
Phedra	RHW 4HW	
Zeta	RHZ, RHW	
<b>Peugeot</b>		
206	DW10TD	
306 / Break	DW10TD	
307	DW10TD DW10ATED	MAN MAN
406 / Break	DW10TD DW10ATED DW12TED4	MAN MAN
607	DW12TED4	
806	DW10ATED DW10ATED4	
807	DW10ATED4 DW12TED4	
Boxer	DW10TD DW12TED	no air condition no air condition
Expert	DW10ATED DW10ATED4 DW10BTED	
Partner	DW8B DW8B DW10TD DW10TD	air condition/ Code: M59F, M59U air condition/ O 09154 -> / Code:M49F Code: M59F, M59U MAN / Code: M49F

# CORTECO 21653150



Peugeot Boxer 04/2002 ->

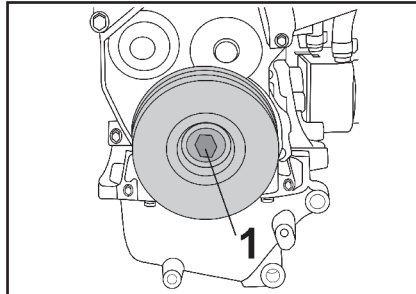

DW10TD, DW12TED

1 -> 50 Nm±5Nm(Loctite)  
+ 62°±5°

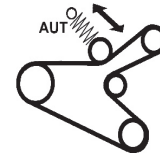

Fiat Ulysse 08/2002 ->, Lancia Phedra, Zeta, Peugeot 406 (2,2HDI), 607, 807

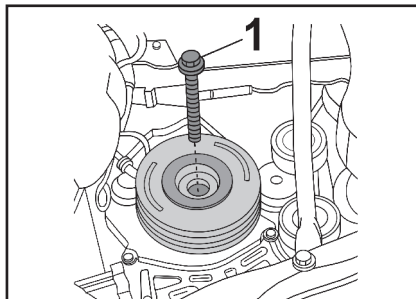

RHW, 4HW, RHZ  
DW12TED4,  
DW10ATED4

1 -> 70 Nm + 60°(Loctite)

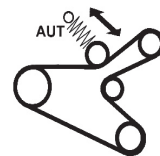

Fiat Ducato, Scudo, Ulysse -> 08/2002, Peugeot 206, 306, 307, 406, 806,  
Boxer 08/2001 -> 04/2002, Expert Partner

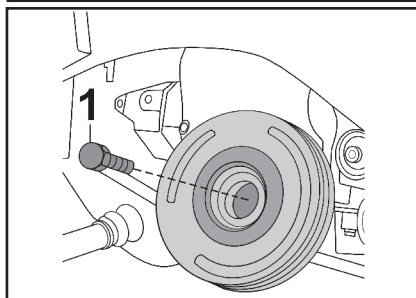

DW8B, DW10TD, RHV  
RHX, RHZ, DW10ATED,  
DW10ATED4, DW10BTED

1 -> 40Nm + 51° (Loctite)

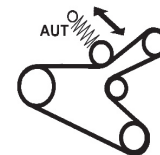

Citroen Berlingo

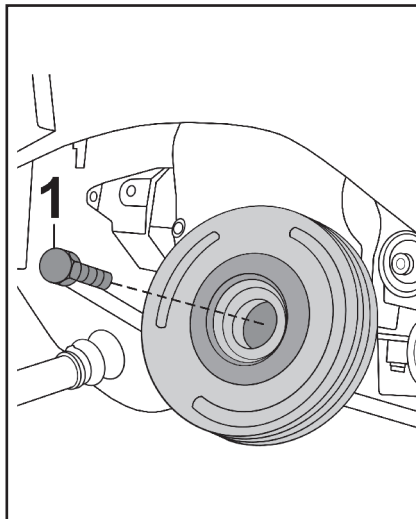

DW10TD

1 -> 40Nm + 51° (Loctite)

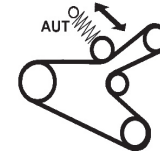

DW8B

1 -> 40Nm + 51° (Loctite)  
2 -> 115±10 Seem

