



**D**

### Vor der Montage zu beachten:

Radlagersätze sind sicherheitsrelevante Teile und können durch falsche Montage oder falsche Einstellung zu schweren Unfällen führen. Um Zwischenfälle zu vermeiden, ist es äußerst wichtig, dass die Anweisungen der Fahrzeughersteller, die auch in gewissen technischen Handbüchern zu finden sind, detailgetreu befolgt werden. Das Wechseln eines Radlagers sollte nur von Fachleuten mit einschlägiger Ausbildung und Erfahrung im Kfz-Handwerk vorgenommen werden.

- Die Montagearbeiten des Wälzlagers müssen in einer sauberen, staubfreien Umgebung vorgenommen werden.
- Vor der Montage müssen der einwandfreie geometrische und der allgemeine Zustand der Umbauteile überprüft werden.
- Alle Bauteile, die nicht zum Lieferumfang des Radlagersatzes gehören, sollten auf ihre Funktion hin überprüft werden.
- Die Lager dürfen erst unmittelbar vor dem Einbau aus ihrer Verpackung entnommen werden.
- Beim Aus- und Einbau sowie bei der Einstellung muss entsprechendes Werkzeug verwendet werden.
- Auf Sauberkeit während der Montage ist zu achten. Verunreinigungen, die während der Montage entstehen, müssen mit einem sauberen Lappen gereinigt werden.
- Das Wälzlager darf nicht zerlegt werden.
- Achten Sie darauf, dass das Wälzlager und die Dichtungen in die richtige Richtung montiert werden.
- Bei offenen Wälzlager ist es wichtig, die Wälzkörper kräftig einzuschmieren und die Dichtlippe der zu verwendenden Dichtungen einzufetten. Bitte dazu nur geeignetes „Wälzlagerfett“ verwenden!
- Das Wälzlager mit dem vom Fahrzeughersteller empfohlenen Werkzeug einpressen und/oder mit einem Rohr mit passendem Durchmesser montieren. Die Kräfte müssen immer auf der Fläche des Lagerringes wirken, der eingepresst wird.
- Die vom Fahrzeughersteller angegebenen Drehmomente sind einzuhalten. Prüfen Sie die zusammengesetzte Einheit (Schwergängigkeit, Spiel, Vibrationen, etc.).

### Magnetkodierung

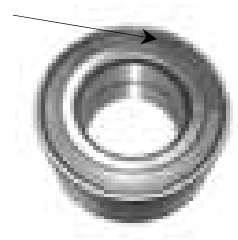

**D**

### Achtung: Radlager mit Magnetkodierung

Das Radlager enthält auf einer Seite eine schwarze Magnetkodierdichtung. Diese ist durch einen Kunststoffdeckel geschützt. Folgende generelle Montageanweisungen sind aus Sicherheitsgründen zu beachten:

- Kunststoffdeckel erst unmittelbar vor dem Einbau entfernen.
- Achten Sie darauf, dass das Radlager so eingebaut wird, dass die Magnetkodierung gegenüber dem Sensor liegt, bzw. zur Fahrzeuginnenseite zeigt.
- Die Magnetkodierung ist vor äußeren Einflüssen, wie z.B. Schmutz oder mechanischen Stößen, zu schützen. Vorsicht: Bringen Sie die Magnetkodierung nicht mit Magnetquellen in Berührung!
- Bei der Montage entstandene Verunreinigungen sind mit einem sauberen Tuch zu reinigen.
- Folgen Sie der Montagevorschrift des Fahrzeugherstellers.

**GB**

### Please note when mounting the kit!

Wheel bearing kits are safety critical parts and can lead to serious damage, if they are mounted in a wrong manner. Please follow the security instructions in your technical manuals and all instructions from the manufacturer. Changing wheel bearing kits should only be taken by competent specialists with technical experience.

- All recommendations/instructions of the manufacturer have to be considered.
- Bearings have to be mounted in a clean, dust free working area.
- Bearings should be only taken out from the package just before mounting.
- While mounting, please use appropriate tools.
- Dirt and impurities have to be removed.
- Before mounting, please check the geometrical and general condition of the mating parts.
- The function of all parts which are not included in delivery of the bearing kit should be examined.
- The bearing should not be divided into single parts.
- Important: mount the bearing and the seal in the correct direction.
- Ensure correct greasing when mounting the bearings, especially on seals.
- Press the bearing with the tool recommended by the manufacturer and/or with a tube of the corresponding diameter. The pressure has to be evenly spread on the surface of the bearing.
- Tighten the bearings to the correct torque with a torque wrench.
- Check the complete unit, looking for any problems, vibrations etc.

### Magnetic seal

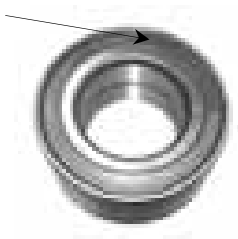

**GB**

### Note! Wheel bearing with magnetic seal:

The wheel bearing contains a black magnetic seal on one side, which is protected with a plastic cover. The following general instructions for assembly are to be considered for safety reasons:

- Remove the plastic cover immediately before the installation.
- The wheel bearing should be inserted in such a way that the magnetic seal is opposite to the sensor and points to the inner vehicle.
- The magnet seal should be protected against external influences, e.g. dirt or mechanical impacts. Don't disturb the magnetic seal via other magnets!
- Dirt has to be cleaned with a clean cloth.
- Follow the assembling instructions of the vehicle manufacturer.

**F**

### A noter avant le montage:

Les kits de roulements de roue sont des pièces de sécurité et peuvent – en cas de mauvais montage – causer de graves accidents. Pour éviter tout incident, il est important de suivre scrupuleusement les instructions de montage préconisées par les constructeurs. Vous trouverez ces instructions également dans certaines revues techniques. Un kit de roulements doit être monté par du personnel qualifié et expérimenté dans la réparation d'automobiles.

### Important!

- le montage du roulement doit être effectué dans un environnement propre et à l'abri de la poussière
- avant le montage, vérifiez le bon état général et la géométrie des pièces environnantes.
- vérifiez le bon fonctionnement de toutes les pièces qui ne font pas parties du kit de roulements
- sortir les roulements de l'emballage juste avant le montage
- utilisez des outils appropriés pour le montage et le démontage
- faire attention à la propreté lors du montage; toute impureté doit être nettoyée immédiatement et méticuleusement
- il ne faut pas détailler un roulement ou ne monter qu'une partie du roulement livré
- vérifiez le sens de montage des roulements et des joints
- bien graisser les roulements à cage ouverte ainsi que les lèvres des joints fournis
- montez le roulement avec les outils préconisés par les constructeurs et/ou avec un tube dont le diamètre correspond à la taille du roulement. Pour tout roulement monté sous pression, il est important que la pression appliquée soit homogène sur la surface entière de la bande du roulement.
- respectez les couples de serrage préconisés par les constructeurs contrôlez l'ensemble de l'unité ( le bon fonctionnement du roulement, le jeu, ou d'éventuelles vibrations etc. )

### Magnétisé avec un code

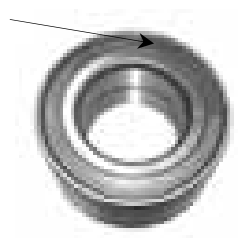

**F**

### Attention ! Roulement de roue avec aimant codé

Le roulement de roue comprend d'un côté un joint noir codé et aimant. Celui-ci est protégé par un couvercle en plastique. Pour des raisons de sécurité, les instructions de montage suivantes sont à suivre scrupuleusement :

- Enlevez le cache de protection au dernier moment - juste avant le montage final.
- Veillez à ce que le montage du roulement soit effectué de la manière à ce que la surface codée soit en face de la sonde et du côté intérieur.
- La surface codée est à protéger contre toute impureté ainsi qu'à toute sorte de choc. Le codage magnétique ne doit pas être approché d'une source aimantée extérieure.
- Nettoyez toute impureté proche du roulement au moment du montage.
- Suivez les instructions de montage du constructeur.



**E**

**Por favor tenga en cuenta durante el montaje del kit!**

Los kits de rueda son elementos críticos de seguridad y pueden ocasionar serios desperfectos si son montados de forma incorrecta. Por favor seguir las instrucciones de seguridad de los manuales técnicos y todas las instrucciones del fabricante. El cambio de kits de rueda debe ser llevado a cabo por especialistas cualificados y con experiencia técnica.

- Todas las recomendaciones/instrucciones del fabricante deben ser tenidas en cuenta.
- Los rodamientos deben ser montados en un área de trabajo limpia y libre de polvo.
- Los rodamientos deben ser sacados del envoltorio justo antes de ser montados.
- Durante el montaje utilizar las herramientas apropiadas.
- Suciedad e impurezas deben ser eliminadas
- Antes del montaje verificar la geometría y estado general de las piezas a ensamblar.
- El funcionamiento de todas las partes no incluidas en el kit de rueda deben ser examinados.
- El rodamiento no debe ser desmontado en partes individuales.
- Importante: montar el rodamiento y junta en la correcta posición.
- Asegurarse del correcto engrase durante el montaje del rodamiento, especialmente en las juntas.
- Apretar el rodamiento con la herramienta recomendada por el fabricante y/o con un tubo del diámetro correspondiente. La presión debe ser repartida en toda la superficie del rodamiento.
- Apretar los rodamientos con el par correcto con un llave de esfuerzo de torsión.
- Comprobar la unidad completa, buscando cualquier problema, vibraciones, etc.

**magnética**

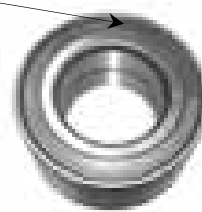

**E**

**Nota: Kit de rueda con junta magnética:**

El rodamiento contiene una junta magnética negra en uno de los lados. Éste esta protegido con una cubierta de plástico. Las siguientes instrucciones generales para el montaje deben ser consideradas por motivos de seguridad:

- Quitar la cubierta de plástico justo ante de la instalación.
- El rodamiento debe ser insertado de forma que la junta magnética esta opuesta al sensor y señala hacia el interior del vehículo.
- La junta magnética debe ser protegida contra agentes externos, polvo o impactos mecánicos y no debe ser influenciada por otros componentes magnéticos.
- El polvo debe ser limpiado con un trapo limpio.
- Seguir las instrucciones de montaje del fabricante.

**PL**

**Uwagi przedmontażowe:**

Zestawy łożyskowe należą do tych części samochodu które w wyniku niefachowego i niewłaściwego montażu mogą być przyczyną powstawania ciężkich wypadków. W celu ich uniknięcia należy ściśle stosować się do wskazówek podawanych przez producenta aut, jak również korzystać z fachowej literatury gdzie dokładnie opisane są etapy postępowania w trakcie wymiany zestawu. Wymiany mogą wykonywać tylko autoryzowane warsztaty samochodowe lub wyszkolone specjalnie w tym celu osoby.

- Wymiana zestawu łożyskowego musi być dokonana w czystym pozbawionym kurzu pomieszczeniu.
- przed wymiana należy sprawdzić ogólny stan techniczny wymienianych części
- należy sprawdzić stan techniczny pozostałych części w obrębie montażu
- łożysko może być wyjęte z opakowania tylko bezpośrednio przed zamontowaniem do wy- oraz zamontowania i ustawienia łożyska należy użyć specjalnie do tego celu przeznaczonych narzędzi
- należy uważać aby w trakcie montażu nie dostały się żadne zanieczyszczenia
- należy zwracać uwagę aby łożyska i uszczelniacze były montowane we właściwym kierunku
- przy łożyskach tzw. otwartych należy użyć i wystarczająco nasmarować smarów specjalnie do tego przeznaczonych
- polecane przez producenta aut parametry montażu muszą dla łożysk być ściśle zachowane np. średnica itp.

**Magnetyczne kodowanie**

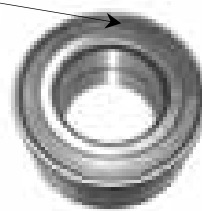

**PL**

**Uwaga! Łożyska z magnetycznym kodowaniem:**

Łożysko posiada na jednej stronie czarną uszczelkę, pod którą znajduje się czujnik magnetyczny, który dodatkowo chroniony jest przez wisko z tworzywa sztucznego. Ze względów bezpieczeństwa, podczas montażu, powinno się przestrzegać następujące polecenia:

- wisko zdjąć bezpośrednio przed montażem.
- należy zwrócić uwagę, aby łożysko było wbudowane kodem magnetycznym w stronę z czujnika lub w kierunku środka pojazdu.
- czujnik magnetyczny należy chronić przed zewnętrznymi czynnikami, np. kurz, uderzenia mechaniczne. Przede wszystkim należy unikać kontaktu czujnika magnetycznego z innymi źródłami pola magnetycznego.
- powstałe podczas montażu jakiegokolwiek zabrudzenia należy oczyścić czystym ręcznikiem.
- należy przestrzegać wskazówek producenta pojazdu.

**RUS**

**Внимание: прочитать перед монтажом:**

Подшипники - это защитно-релевантные части и ошибочным монтажом или, неправильной установкой могут привести к тяжелым авариям. Чтобы избежать инцидентов крайне важно, чтобы указания производителя транспортного средства, которые также приложены к техническим руководствам, исполнялись строго в соответствии. Смена подшипника должна производиться только специалистами с соответствующим образованием и опытом работы в профессии автомеханика.

- Монтажные работы по смене подшипника должны производиться в чистом, безпыльном помещении.
- Перед монтажом должно проверяться геометрическое и общее состояние запасных частей.
- Все констр уктивные элементы, которые не принадлежат к комплекту подшипника, должны быть проверены на их функцию.
- Подшипники могут изыматься из ее упаковки только непосредственно перед вмонтированием. При демонтаже и вмонтировании необходимо соблюдать чистоту.
- Загрязнения, которые возникают во время монтажа, должны чиститься чистой тряпкой.
- Подшипник качения не может разбираться.
- Обращайте внимание на то, чтобы подшипник качения и кольцо уплотнения монтировались в правильном направлении.
- При открытых подшипниках качения важно обильно смазывать ролики подшипника и уплотняющий бурт. Используйте для этого только предназначенное масло для подшипника.
- Подшипник качения от производителя тр аспортного средства рекомендовано монтировать под прессом и/или трубой с соответствующим диаметром. Силы должны действовать на площадь кольца подшипника, которое сжимается.
- Производителем транспортного средства указана сила давления которую нужно применять. Проверьте смонтированную единицу (тяжесть хода, звук, вибрация Проверьте смонтированную единицу (тяжесть хода, звук, вибрации и т.д. ...).

**кодированым магнитом**

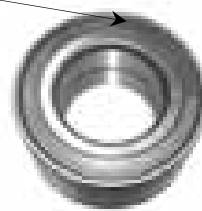

**RUS**

**Внимание: подшипник с кодированым магнитом:**

Подшипник содержит на стороне черное кольцо уплотнения с кодированым магнитом, которое защищено пластмассовой крышкой. Следующие общие инструкции по сборке нужно выполнять в соответствии с техникой безопасности:

- Крышку пластмассы удаляют только непосредственно перед вмонтированием
- Обращайте внимание при установке подшипника, чтобы кодированный магнит лежал напротив сенсора, и соответственно указывал к внутренней стороне транспортного средства
- Кодированный магнит нужно защищать от внешних влияний таких как например: грязь или механические удары. Осторожно: избегать контакта кодированного магнита с другими источниками магнита в соприкосновении
- При монтаже возникшие загрязнения нужно чистить чистой тряпкой
- Следуйте инструкции монтажа производителя транспортного средства кодированым магнитом

**I****Pregho nota quando montano il corredo!**

I corredi del cuscinetto della rotella sono parti critiche di sicurezza e possono condurre a danni seri se sono montati in un modo errato. Segua prego le istruzioni di sicurezza in vostri manuali tecnici e tutte le istruzioni dal fornitore. I corredi cambiati del cuscinetto della rotella debbono essere intrapresi soltanto da esperti competenti con esperienza tecnica:

- tutti i recommendations/instructions del fornitore devono essere considerati
- i cuscinetti devono essere montati in un'area di lavoro pulita e senza polvere
- i cuscinetti debbono essere eliminati soltanto dall'imballaggio appena prima il montaggio
- durante la montatura si prega di usare attrezzi adatti di uso
- la sporcizia e le impurità devono essere rimosse
- prima del montaggio si prego di controllare lo stato geometrico e generale delle parti accoppiamento
- la funzione di tutte le parti che non sono incluse nel corredo del cuscinetto dovrebbe essere esaminata
- il cuscinetto non deve essere diviso nelle singole parti
- importante: montare il cuscinetto e la guarnizione nel senso corretto
- accerti la lubrificazione corretta quando montano i cuscinetti, particolarmente sulle guarnizioni
- premi il cuscinetto con l'attrezzo suggerito dal fornitore e/o con un tubo del diametro corrispondente. La pressione deve essere sparsa uniformemente sulla superficie del cuscinetto
- stringa i cuscinetti alla coppia di torsione corretta con una chiave da coppia di torsione
- controlli l'unità completa, cercando tutti i problemi, vibrazioni ecc.

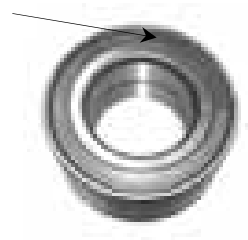
**Codificazione del magnete****I****Nota! Cuscinetto della rotella con la tenuta magnetica:**

Il cuscinetto della rotella contiene una tenuta magnetica nera da un lato. Ciò è protetta con una copertura di plastica. Le seguenti istruzioni generali per il complessivo devono essere considerate per i motivi di sicurezza:

- rimuova la copertura di plastica soltanto prima dell'installazione
- il cuscinetto della rotella dovrebbe essere inserito in modo tale che la tenuta magnetica è di fronte al sensore ed ai punti al veicolo interno
- la guarnizione del magnete dovrebbe essere protetta dalla sporcizia esterna di influenze per esempio o dagli effetti meccanici e non disturba la tenuta magnetica via altri magneti
- la sporcizia deve essere pulita con un panno pulito
- segua le istruzioni di complessivo del fornitore

**CZ****Upozornění před montáží:**

Ložiskové sady kol jsou dily významné z hlediska bezpečnosti a mohou vést nesprávnou montáží nebo chybným nastavením k těžkým dopravním nehodám. Aby se těmito případy zabránilo, je obzvláště důležité, aby se dodržovaly přesné detailní pokyny výrobce vozidla, které je možno nalézt v určitých technických příručkách. Výměna ložiska kola by měla být provedena jen odborníky s příslušným vzděláním a zkušeností v oboru autoopravenství.

- Montážní práce valivého ložiska musí být prováděny v čistém a bezprašném prostředí
- Před montáží musí být přezkoušen bezchybný geometrický a všeobecný stav dílů souvisejících s opravou
- Všechny opravárenské díly, které nepatří do obsahu dodávky sady ložiska kola, musí být přezkoušeny na svoji funkčnost
- Ložiska smějí být vyjmuty ze svého balení teprve bezprostředně před zamontováním
- Při vymontování a zamontování, jakož i při nastavení, musí být použito odpovídající nářadí
- Během montáže je třeba dbát na čistotu. Nečistoty, které během montáže vznikají, musí být očištěny čistým hadrem
- Valivé ložisko se nesmí rozebírat
- Dbejte na to, aby se valivé ložisko a těsnění montovalo správným směrem
- U otevřených valivých ložisek je důležité vydatně namazat valivé těleso a rovněž je třeba namazat těsnící plochy použitých těsnění. K tomu prosím používat pouze vhodný tuk k mazání valivých ložisek!
- Valivé ložisko je nutno nalisovat nářadím, doporučeným výrobcem vozu a/nebo trubicou s odpovídajícím průměrem. Síly musí vždy působit na plochu ložiskového kroužku, který se zalisovává.
- Je třeba dodržovat utahovací momenty udávané výrobcem vozu.
- Přezkoušejte dohromady sestavený celek (těžkost chodu, vůli, vibrace, atd.)

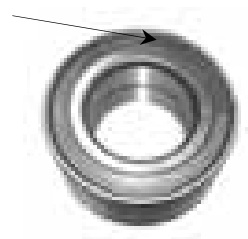
**Magnetickým****CZ****Pozor: ložiska s magnetickým kódováním**

Ložisko kola obsahuje na jedné straně černé těsnění s magnetickým kódováním. To je chráněno plastovým krytem. Z bezpečnostních důvodů je třeba dbát následujících montážních pokynů:

- Plastový kryt je třeba sejmout teprve bezprostředně před namontováním
- Dbejte na to, aby bylo ložisko kola namontováno tak, že magnetické kódování leží naproti senzoru, případně ukazuje na vnitřní stranu vozu
- Magnetické kódování je třeba chránit před vnějšími vlivy, jako např. nečistotami nebo mechanickými rázy. Pozor: nedávejte magnetické kódování do styku s magnetickými zdroji
- Nečistoty vznikající během montáže je třeba očistit čistým hadrem
- Postupujte při montáži podle předpisu výrobce vozu

**BEMERKUNGEN  
REMARKS  
OBSERVATIONS**



**OPTIMAL**

**NEUE RADLAGERSÄTZE / NEW KITS  
KITS DE ROULEMENTS POUR ROUES NOUVEAUX**

|         |                          |
|---------|--------------------------|
| 101 699 | Audi, Seat, VW           |
| 102 158 | Seat, VW                 |
| 201 691 | Opel, Vauxhall           |
| 301 583 | Ford                     |
| 301 585 | Ford                     |
| 302 595 | Ford                     |
| 302 597 | Ford                     |
| 401 165 | Mercedes-Benz            |
| 402 467 | Smart-MCC                |
| 402 827 | Mercedes-Benz            |
| 501 513 | BMW                      |
| 502 599 | Mini                     |
| 502 629 | BMW                      |
| 601 834 | Citroën, Peugeot, Toyota |
| 602 835 | Citroën, Peugeot, Toyota |
| 602 893 | Citroën, Peugeot         |
| 701 837 | Dacia                    |
| 702 899 | Renault                  |
| 801 829 | Fiat, Suzuki             |
| 802 826 | Alfa Romeo               |
| 891 591 | Volvo                    |
| 892 587 | Volvo                    |
| 892 589 | Volvo                    |
| 911 831 | Honda                    |
| 912 786 | Honda                    |
| 922 697 | Hyundai                  |
| 922 825 | Kia                      |
| 922 871 | Hyundai                  |
| 951 833 | Mitsubishi               |
| 961 819 | Nissan                   |
| 961 828 | Nissan                   |
| 962 823 | Nissan                   |
| 962 824 | Nissan                   |
| 971 821 | Suzuki                   |
| 981 149 | Toyota                   |
| 981 824 | Toyota                   |
| 982 782 | Toyota                   |
| 991 788 | Chrysler                 |
| 991 861 | Chrysler                 |
| 991 863 | Chrysler                 |

**NICHT MEHR IM PROGRAMM / DELETED KITS  
HORS DU PROGRAMME**

|         |         |
|---------|---------|
| 101 005 | 912 990 |
| 301 767 | 941 689 |
| 301 911 | 942 844 |
| 302 913 | 942 845 |
| 601 582 | 952 298 |
| 681 919 | 961 883 |
| 682 593 | 962 227 |
| 682 892 | 981 535 |
| 801 574 | 981 849 |
| 881 523 | 982 211 |
| 881 879 | 991 655 |
| 891 509 | 991 657 |
| 912 293 | 992 659 |

**GEÄNDERTE RADLAGERSÄTZE / REPLACED KITS  
LISTE DE KITS REMPLACÉS**

|         |   |         |
|---------|---|---------|
| 501 497 | → | 501 121 |
| 501 650 | → | 502 135 |
| 891 928 | → | 891 477 |
| 971 973 | → | 971 723 |



**I. RADLAGERSÄTZE / WHEEL BEARING KITS / KITS DE ROULEMENTS DE ROUES**
**A. Kfz-Hersteller / Car Manufacturers / Constructeurs:**

|                         |           |
|-------------------------|-----------|
| ALFA ROMEO .....        | 1 - 3     |
| AUDI .....              | 4 - 9     |
| AUTOBIANCHI .....       | 10 - 10   |
| BMW .....               | 11 - 17   |
| CHRYSLER .....          | 18 - 18   |
| CITROËN .....           | 19 - 22   |
| DACIA .....             | 23 - 23   |
| DAEWOO .....            | 24 - 24   |
| DAIHATSU .....          | 25 - 26   |
| DAIMLER .....           | 27 - 27   |
| DODGE .....             | 28 - 28   |
| FIAT .....              | 29 - 36   |
| FORD .....              | 37 - 41   |
| HONDA .....             | 42 - 45   |
| HYUNDAI .....           | 46 - 47   |
| ISUZU .....             | 48 - 48   |
| IVECO .....             | 49 - 50   |
| JAGUAR .....            | 51 - 51   |
| KIA .....               | 52 - 53   |
| LADA (VAZ) .....        | 54 - 54   |
| LANCIA .....            | 55 - 57   |
| LAND-ROVER .....        | 58 - 58   |
| LEXUS .....             | 59 - 59   |
| LEYLAND-DAF .....       | 60 - 60   |
| MAZDA .....             | 61 - 64   |
| MERCEDES-BENZ .....     | 65 - 69   |
| MINI .....              | 70 - 70   |
| MITSUBISHI .....        | 71 - 75   |
| NISSAN .....            | 76 - 80   |
| OPEL .....              | 81 - 85   |
| PEUGEOT .....           | 86 - 90   |
| POLSKI FIAT / FSO ..... | 91 - 91   |
| PORSCHE .....           | 92 - 92   |
| PROTON .....            | 93 - 93   |
| RENAULT .....           | 94 - 104  |
| ROVER GROUP .....       | 105 - 106 |
| SAAB .....              | 107 - 107 |
| SEAT .....              | 108 - 109 |
| SKODA .....             | 110 - 110 |
| SMART-MCC .....         | 111 - 111 |
| SUBARU .....            | 112 - 112 |
| SUZUKI .....            | 113 - 114 |
| TALBOT .....            | 115 - 115 |
| TALBOT - EXPRESS .....  | 116 - 116 |
| TOYOTA .....            | 117 - 123 |
| TRIUMPH .....           | 124 - 124 |
| VAUXHALL .....          | 125 - 128 |
| VOLKSWAGEN .....        | 129 - 133 |
| VOLVO .....             | 134 - 135 |
| ZASTAVA .....           | 136 - 136 |



|  |                  |
|--|------------------|
| <b>B. Satz-Verzeichnis / Kit Index / Index des kits</b> .....          | <b>137 - 197</b> |
| <b>C. Satz-Inhalt / Content of kits / Contenu des kits</b> .....       | <b>198 - 219</b> |
| <b>D. Vergleichslisten / Comparison lists / Liste des équivalences</b> |                  |
| Vergleichs-Nr. / OPTIMAL Nr. ....                                      | 220 - 229        |
| OPTIMAL Nr. / Vergleichs-Nr. ....                                      | 230 - 239        |
| Ref.-Nr. / OPTIMAL Nr. ....  | 240 - 285        |
| OPTIMAL Nr. / Ref.-Nr. ....  | 286 - 331        |
| <b>E. Fotos / Pictures / Photos</b> .....                              | <b>332 - 377</b> |

## **II. RADNABEN / WHEEL HUBS / MOYEUX DE ROUES**

|  |                  |
|--|------------------|
| <b>A. Kfz-Hersteller / Car Manufacturers / Constructeurs:</b>          |                  |
| ALFA ROMEO .....   | 378 - 378        |
| AUDI .....   | 379 - 379        |
| CITROËN .....  | 380 - 380        |
| FIAT .....   | 381 - 381        |
| FORD .....   | 382 - 382        |
| LADA (VAZ) .....   | 383 - 383        |
| LANCIA .....   | 384 - 384        |
| OPEL .....   | 385 - 385        |
| PEUGEOT .....  | 386 - 386        |
| RENAULT .....  | 387 - 387        |
| SEAT .....   | 388 - 388        |
| SKODA .....  | 389 - 389        |
| VOLKSWAGEN .....   | 390 - 391        |
| <b>B. Satz-Verzeichnis / Kit Index / Index des kits</b> .....          | <b>392 - 394</b> |
| <b>C. Vergleichslisten / Comparison lists / Liste des équivalences</b> |                  |
| Vergleichs-Nr. / OPTIMAL Nr. ....                                      | 395 - 395        |
| OPTIMAL Nr. / Vergleichs-Nr. ....                                      | 396 - 396        |
| Ref.-Nr. / OPTIMAL Nr. ....  | 397 - 397        |
| OPTIMAL Nr. / Ref.-Nr. ....  | 398 - 398        |
| <b>D. Fotos / Pictures / Photos</b> .....                              | <b>399 - 401</b> |

## **III. SPEZIALWERKZEUGE / SPECIAL TOOLS / OUTILS SPÉCIAUX**

|  |                  |
|--|------------------|
| <b>A. Deutsche Version / German version / Version allemande</b> .....  | <b>402 - 408</b> |
| <b>B. Englische Version / English version / Version anglaise</b> ..... | <b>409 - 415</b> |

Dieser Katalog wurde mit großer Sorgfalt zusammengestellt.  
Dennoch kann für die darin gemachten Angaben und Hinweise keine Gewähr übernommen werden.  
Herstellernamen und -nummern sind nur zu Informationszwecken aufgeführt.

All data in the catalogue have been carefully checked.  
No liability, however, can be accepted for any errors.  
Original replacement numbers are for comparison reasons only.

Toutes les données de ce catalogue ont été soigneusement contrôlées.  
Nous déclinons cependant toute responsabilité pour des erreurs éventuelles.  
Les numéros des pièces de rechange d'origine sont présents seulement dans un but de comparaison.

Wszystkie dane w katalogu zostały dokładnie sprawdzone,  
niemniej wydawca nie ponosi żadnej odpowiedzialności za ewentualne błędy.  
Oryginalne numery zamienników podane są tylko w celach informacyjnych.



|                              | D   | GB                                       | F  |
|------------------------------|---|--|--|
|                              | Trommelbremsen                                  | Drum brakes                              | Freins à tambour                                     |
|                              | Scheibenbremsen                                 | Disc brakes                              | Freins à disques                                     |
|                              | Limousinen                                      | Passenger cars                           | Voiture  |
|                              | Kombiwagen                                      | Estate cars                              | Voiture commerciale                                  |
|                              | Lieferwagen                                     | Light trucks                             | Véhicules utilitaires                                |
|                              | Rad   | Wheel                                    | Roue   |
|                              | Räder mit x Löcher                              | Wheel with x holes                       | Roues avec x trous                                   |
|                              | Anzahl der Zahnzacken                           | Numbers of teeth                         | Nombre de dents                                      |
|                              | Lager   | Bearing                                  | Roulement  |
|                              | Europäische Modelle                             | European models                          | Modèles européens                                    |
|                              | Für die italienischen Modelle                   | Models for Italy                         | Modèles italiens                                     |
|                              | Für die schwedischen Modelle                    | Models for Sweden                        | Modèles suédois                                      |
|                              | Für die schweizer Modelle                       | Models for Switzerland                   | Modèles suisses                                      |
|                              | Für die türkischen Modelle                      | Models for Turkey                        | Modèles turcs  |
|                              | Zwillingsräder                                  | Twin wheel                               | Roues jumelées                                       |
|                              | Achse   | Axle                                     | Essieu   |
|                              | Einzelradaufhängung                             | Independent suspension                   | Suspension indépendante                              |
|                              | Starrachse                                      | Rigid axle                               | Essieu rigide  |
|                              | Verlängerter Radstand                           | Extended wheel base/long body            | Voie des roues allongée                              |
|                              | Linkes Rad                                      | Left wheel                               | Roue gauche  |
|                              | Rechtes Rad                                     | Right wheel                              | Roue droite  |
|                              | Mit erweiterter Traglast                        | With extended load                       | Avec charge plus élevée                              |
|                              | Dichtung  | Seal                                     | Bague d'étanchéité                                   |
|                              | Servolenkung                                    | Power steering                           | Direction assistée                                   |
|                              | Produziert in Frankreich                        | Manufactured in France                   | Produit en France                                    |
|                              | Produziert in Großbritannien                    | Manufactured in Great Britain            | Produit en Grande-Bretagne                           |
|                              | Produziert in Brasilien                         | Manufactured in Brazil                   | Produit au Brésil                                    |
| {Front ... }                 | Vorderachse                                     | Front axle                               | Essieu avant   |
| {Rear ... }                  | Hinterachse                                     | Rear axle                                | Essieu arrière                                       |
| <b>2WS</b>                   | 2-Rad-Lenkung                                   | 2 wheel steering                         | 2 roues directrices                                  |
| <b>4WS</b>                   | 4-Rad-Lenkung                                   | 4 wheel steering                         | 4 roues directrices                                  |
| <b>ABS</b>                   | Antiblockiersystem                              | Anti block system                        | Système d'anti-patinage                              |
| <b>AC</b>                    | Klimaanlage                                     | Air conditioning                         | Air conditionné                                      |
| <b>Airbag</b>                | Airbag  | Airbag                                   | Coussin d'air  |
| <b>ASC+T</b>                 | Automatische Stabilitäts und Traktionskontrolle | Automatic stability and traction control | Stabilisation automatique et contrôle de la traction |
| <b>Aut.GBX</b>               | Automatikgetriebe                               | Automatic transmission                   | Boîte automatique                                    |
| <b>Ch.</b>                   | Fahrgestellnummer                               | Chassis No.                              | No. de chassis                                       |
| <b>Differential brakes</b>   | Bremse neben dem Differential                   | Differential brakes                      | Freins à la sortie du différentiel                   |
| <b>EDC</b>                   | Elektronische Dämpfungskontrolle                | Electronic damping control               | Contrôle électronique de la suspension               |
| <b>E.T.C.</b>                | Elektronische Traktionskontrolle                | Electronic traction control              | Contrôle électronique de la traction                 |
| <b>Full-floating axle</b>    | Unbelastete Achse                               | Full-floating axle                       | Essieu flottant                                      |
| <b>HD</b>                    | Schwerlast                                      | Heavy duty                               | Poids lourds   |
| <b>Hub brakes</b>            | Bremse an der Radnabe                           | Hub brakes                               | Freins sur moyeu                                     |
| <b>Level adj.</b>            | Niveauregulierung                               | Level adjustment                         | Niveau d'ajustement                                  |
| <b>LHD</b>                   | Linkslenkung                                    | Left hand drive                          | Volant à gauche                                      |
| <b>Man.GBX</b>               | Mechanisches Getriebe                           | Manual transmission                      | Boîte manuelle                                       |
| <b>Mot.</b>                  | Motor   | Engine                                   | Moteur   |
| <b>Reinforced suspension</b> | Mit verstärkter Aufhängung                      | With heavy duty suspension               | Avec suspension renforcée                            |
| <b>RHD</b>                   | Rechtslenkung                                   | Right hand drive                         | Volant à droite                                      |
| <b>Semi-floating axle</b>    | Halbbelastete Achse                             | Semi-floating axle                       | Essieu semi-flottant                                 |
| <b>x-Doors</b>               | x-Türen   | x-Doors                                  | x-Portes   |
|                              | Ohne  | Without                                  | Sans   |

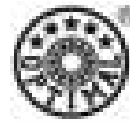

|                              | <b>PL</b>                               | <b>CZ</b>                               | <b>E</b>                          |
|------------------------------|---|---|-----------------------------------|
|                              | Hamulce bębnowe                         | bubnové brzdy                           | frenos de tambor                  |
|                              | Hamulce tarczowe                        | kotoučové brzdy                         | frenos de disco                   |
|                              | Samochód osobowy                        | limuzína                                | turismos                          |
|                              | Kombi                                   | kombi                                   | camioneta                         |
|                              | Samochód dostawczy                      | dodávkový vůz                           | camionetas                        |
|                              | Koło                                    | kolo                                    | rueda                             |
|                              | Otwory mocujące                         | kola s x otvory                         | ruedas x taldras                  |
|                              | Liczba zębów                            | počet zubů                              | número de dientes                 |
|                              | Łożysko                                 | ložisko                                 | rodamientos                       |
|                              | Modele europejskie                      | evropské modely                         | modelos europeos                  |
|                              | Modele na rynek włoski                  | modely pro Itálii                       | modelos italianos                 |
|                              | Modele na rynek szwedzki                | modely pro Švédsko                      | modelos suecos                    |
|                              | Modele na rynek szwajcarski             | modely pro Švýcarsko                    | modelos suizos                    |
|                              | Modele na rynek turecki                 | modely pro Turecko                      | modelos turcos                    |
|                              | Koła bliźniacze                         | dvojmontáž kol                          | ruedas gemelas                    |
|                              | Oś                                      | osa                                     | eje                               |
|                              | Niezależne zawieszenie kół              | nezávislé zavěšení kol                  | suspensión independiente          |
|                              | Oś sztywna                              | tuhá náprava                            | punte rigido                      |
|                              | Wydłużone nadwozie                      | prodloužený rozvor                      | distancia entre ejes prolongada   |
|                              | Lewe koło                               | levé kolo                               | rueda izquierda                   |
|                              | Prawe koło                              | pravé kolo                              | rueda derecha                     |
|                              | Modele ze zwiększoną nośnością          | modely se zvýšenou nosností             | con carga elevada                 |
|                              | Uszczelniacz                            | těsnění                                 | anilla                            |
|                              | Wspomaganie kierownicy                  | servořízení                             | servodirección                    |
|                              | Wyprodukowane we Francji                | vyrobené ve Francii                     | fabricado en Francia              |
|                              | Wyprodukowane w Anglii                  | vyrobené v Anglii                       | fabricado en Gran Bretaña         |
|                              | Wyprodukowane w Brazylii                | vyrobené v Brazílii                     | fabricado en Brasil               |
| {Front ... }                 | Dotyczy przedniej osi                   | přední ...                              | eje delante                       |
| {Rear ... }                  | Dotyczy tylnej osi                      | zadní ...                               | eje trasero                       |
| <b>2WS</b>                   | 2 koła skrętne                          | pohon 2 kol                             | tracción 2 x 4                    |
| <b>4WS</b>                   | 4 koła skrętne                          | pohon 4 kol                             | tracción 4 x 4                    |
| <b>ABS</b>                   | Modele z układem ABS                    | antibloksystém                          | ABS                               |
| <b>AC</b>                    | Modele z układem klimatyzacji           | klimatizace                             | aire acondicionado                |
| <b>Airbag</b>                | Modele z poduszką powietrzną            | airbag                                  | airbag                            |
| <b>ASC+T</b>                 | Układ Kontroli Trakcyjnej               | automatická stabilita a kontrola trakce | control de estabilidad automático |
| <b>Aut.GBX</b>               | Automatyczna skrzynia biegów            | automatická převodovka                  | cambio automático                 |
| <b>Ch.</b>                   | Numer nadwozia                          | číslo karoserie                         | números de chasis                 |
| <b>Differential brakes</b>   | Hamulce montowane od strony             | brzda diferenciálu                      | freno al lado del diferencial     |
| <b>EDC</b>                   | Układ EDC                               | elektronická kontrola pérování          | control electronico de suspensión |
| <b>E.T.C.</b>                | Elektroniczny Układ Kontroli Trakcyjnej | elektronická kontrola trakce            | control electronico de tracción   |
| <b>Full-floating axle</b>    | Oś odciążona                            | výkyvná náprava                         | eje trasero flotante              |
| <b>HD</b>                    | Modele o podwyższonej wytrzymałości     | zesílené provedení                      | carga                             |
| <b>Hub brakes</b>            | Hamulce montowane od strony piasty      | brzdy s nábojem kola                    | frenos                            |
| <b>Level adj.</b>            | Z regulacją poziomu                     | nivomat                                 | suspensión autonivelante          |
| <b>LHD</b>                   | Kierownica z lewej strony               | levostranné řízení                      | conducción a la izquierda         |
| <b>Man.GBX</b>               | Manualna skrzynia biegów                | mechanická převodovka                   | cambio mecánico                   |
| <b>Mot.</b>                  | Silnik                                  | motor                                   | motor                             |
| <b>Reinforced suspension</b> | Modele ze wzmocnionym zawieszeniem      | modely s HD tlumením                    | suspensión reforzada              |
| <b>RHD</b>                   | Kierownica z prawej strony              | pravostranné řízení                     | conducción a la derecha           |
| <b>Semi-floating axle</b>    | Oś półodciążona                         | tuhá náprava s 1 ložiskem na konci      | eje trasero semiflotante          |
| <b>x-Doors</b>               | Ilość drzwi                             | x-dveřový                               | x puertas                         |
|                              | Z wyjątkiem                             | kromě                                   | sin                               |



# OPTIMAL

## SYMBOLE SYMBOLS SYMBOLES

CS













HR

RUS

|                              |   |   |  |
|------------------------------|---|---|--|
|                              | Kočioni doboš   | Kočioni bubanj  | Барабанный тормоз  |
|                              | Kočioni diskovi   | Kočioni diskovi   | Дисковый тормоз  |
|                              | Limuzina  | Limuzina  | Лимузин  |
|                              | Karavan   | Karavan   | Автомобиль-универсал   |
|                              | Vozilo za dostavku  | Furgon  | Автомобиль-фургон  |
|                              | Točak   | Kotač   | Колесо   |
|                              | Točkovi sa x brojem rupa                                    | Kotači sa x brojem rupa                                     | Колеса с x отверстиями   |
|                              | Broj zubaca   | Broj zubaca   | Количество зубурин   |
|                              | Ležaj   | Ležaj   | Подшипник  |
|                              | Evropski modeli   | Evropski modeli   | Европейские модели   |
|                              | Za italijanske modele                                       | Za talijanske modele  | Для итальянских моделей  |
|                              | Za švedske modele   | Za švedske modele   | Для шведских моделей   |
|                              | Za švicarske modele   | Za švicarske modele   | Для швейцарских моделей  |
|                              | Za turske modele  | Za turske modele  | Для турецких моделей   |
|                              | Dva para točkova po osovini                                 | Dva para kotača po osovini                                  | Сдвоенные колеса   |
|                              | Osovina   | Osovina   | Ось  |
|                              | Pojedinačni držaci točka                                    | Pojedinačni držaci kotača                                   | Независимая подвеска   |
|                              | Jednodjelna osovina   | Jednodjelna osovina   | Цельная ось  |
|                              | Produženi razmak točkova                                    | Produženi razmak kotača                                     | Удлиненная база шасси  |
|                              | Levi točak  | Lijevi kotač  | Левое колесо   |
|                              | Desni točak   | Desni kotač   | Правое колесо  |
|                              | Sa povišenom sveukupnom nosivošću                           | Sa povišenom sveukupnom nosivošću                           | С повышенной грузоподъемностью                                 |
|                              | Dihtung   | Brtilo  | Уплотнение   |
|                              | Hidraulički sistem za upravljanje vozilom                   | Hidraulični sustav za upravljanje                           | Сервоуправление  |
|                              | Izrađeno u Francuskoj                                       | Izrađeno u Francuskoj                                       | Сделано во Франции   |
|                              | Izrađeno u Velikoj Britaniji                                | Izrađeno u Velikoj Britaniji                                | Сделано в Великобритании                                       |
|                              | Izrađeno u Brazilu  | Izrađeno u Brazilu  | Сделано в Бразилии   |
| {Front ... }                 | Prednja osovina   | Prednja osovina   | Передняя ось   |
| {Rear ... }                  | Zadnja osovina  | Zadnja osovina  | Задняя ось   |
| <b>2WS</b>                   | Upravljački sistem na dva točka                             | Upravljački sustav na dva kotača                            | Рулевое управление на 2 колеса                                 |
| <b>4WS</b>                   | Upravljački sistem na četiri točka                          | Upravljački sustav na četiri kotača                         | Рулевое управление на 4 колеса                                 |
| <b>ABS</b>                   | Sistem protiv proklizavanja kočnica-ABS                     | Sustav protiv proklizavanja kotača                          | Противоблокировочная система                                   |
| <b>AC</b>                    | Sistem za klimatizaciju                                     | Sustav za klimatizaciju                                     | Кондиционер  |
| <b>Airbag</b>                | Vazdušni jastuk-Airbag                                      | Zračni jastuk   | Подушка безопасности   |
| <b>ASC+T</b>                 | Automatski sistem za stabilizaciju održavanje putnog pravca | Automatski sustav stabilizovanja i održavanja putnog pravca | Автоматическая система контроля устойчивости и тягового усилия |
| <b>Aut.GBX</b>               | Automatski menjač   | Automatski mjenjač  | Автоматическая коробка передач                                 |
| <b>Ch.</b>                   | Broj šasije   | Broj Šasije   | Номер шасси  |
| <b>Differential brakes</b>   | Kočnice pored diferencijala                                 | Kočnice pored diferencijala                                 | Тормоз возле дифференциала                                     |
| <b>E.T.C.</b>                | Elektronski sistem za održavanje pravca                     | Elek. sustav za održavanje putnog pravca                    | Электронный контроль тягового усилия                           |
| <b>Full-floating axle</b>    | Osovina bez opterećenja                                     | Osovina bez opterećenja                                     | Ненагруженная ось  |
| <b>HD</b>                    | Opterećenje   | Opterećenje   | Тяжеловесный груз  |
| <b>Hub brakes</b>            | Kočnice na glavčini točka                                   | Kočnice na glavčini kotača                                  | Тормоз на ступице колеса                                       |
| <b>Level adj.</b>            | Sistem za podesavanje nivoa vozila                          | Upravljanje razinom vozila                                  | Регулировка высоты автомобиля                                  |
| <b>LHD</b>                   | Vozač na levoj strani                                       | Vozač na lijevoj strani                                     | Левое рулевое управление                                       |
| <b>Man.GBX</b>               | Mehanički menjač  | Mehanički mjenjač   | Механическая коробка передач                                   |
| <b>Mot.</b>                  | Motor   | Motor   | Двигатель  |
| <b>Reinforced suspension</b> | Sa pojačanim držacima                                       | Sa pojačanim držacima                                       | С усиленной подвеской  |
| <b>RHD</b>                   | Vozač na desnoj strani                                      | Vozač na desnoj strani                                      | Правое рулевое управление                                      |
| <b>Semi-floating axle</b>    | Delomичno opterećena osovina                                | Djelomično opterećena osovina                               | Полунагруженная ось  |
| <b>x-Doors</b>               | x-broj vrata  | x-broj vrata  | x-дверей   |
|                              | Osim  | Osim  | Без  |







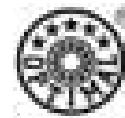



























| MODELL/MODEL/MODELE                             |  | BEMERKUNGEN/REMARKS/<br>REMARQUES   |  |  |
|---|---|---|---|---|
| Alfa 6  | 79 → 85   |  | 801 554   | 802 558   |
| Alfa 6  | 79 → 85   |  | 801 554   | 802 556   |
| Alfa 33   | 83 → 03/89  | <del>ABS</del>  | 801 478   | 802 652   |
| Alfa 33   | 88 → 12/89  |   | 04-P209   | -   |
| Alfa 33   | 83 → 03/89  | ABS   | 801 478   | -   |
| Alfa 33   | 12/89 → -   |   | 04-P215   | -   |
| Alfa 33   | 04/89 → 94  | <del>ABS</del>  | 801 428   | 802 652   |
| Alfa 33 1.4, 1.7 i.e. 8/16V                     | 91 → 94   |   | 04-P215   | -   |
| Alfa 33   | 04/89 → 94  | ABS   | 801 428   | -   |
| Alfa 33 4x4                                     | 84 → 03/89  |   | 801 478   | 802 488   |
| Alfa 33 4x4                                     | 04/89 → 05/91   |   | 801 428   | 802 488   |
| Alfa 33 4x4                                     | 06/91 → 94  |   | 801 428   | 802 528   |
| Alfa 75   | 05/85 → 09/85   |  | 801 438   | 802 558   |
| Alfa 75   | 05/85 → 09/85   |  | 801 438   | 802 556   |
| Alfa 75   | 10/85 → 92  |  | 801 438   | 802 540   |
| Alfa 75   | 10/85 → 92  |  | 801 438   | 802 542   |
| Alfa 75 Turbo Evoluzione                        | 89 → 91   |   | 801 554   | -   |
| Alfa 90   | 84 → 09/85  |  | 801 438   | 802 558   |
| Alfa 90   | 84 → 09/85  |  | 801 438   | 802 556   |
| Alfa 90   | 10/85 → 87  |  | 801 438   | 802 540   |
| Alfa 90   | 10/85 → 87  |  | 801 438   | 802 542   |
| Alfa 145  | 94 → -  |   | 04-P197   | -   |
| Alfa 145  | 94 → 98   | <del>ABS</del>  | 800 398   | 802 330   |
| Alfa 145 1.4 i.e., 1.6 i.e., 1.7 i.e., 1.8 i.e. | 99 → 01   | <del>ABS</del>  | 800 398   | 802 330   |
| Alfa 145 1.9 JTD                                | 99 → 01   | <del>ABS</del>  | 801 500   | 802 330   |
| Alfa 145 2.0 16V                                | 99 → 01   | <del>ABS</del>  | 800 398   | 802 330   |
| Alfa 145  | 94 → 01/96  | ABS   | 800 398   | 802 378   |
| Alfa 145  | 02/96 → 10/98   | ABS Ch.→3180591   | 800 398   | 802 315   |
| Alfa 145 1.4 i.e., 1.6 i.e., 1.7 i.e., 1.8 i.e. | 10/98 → 01  | ABS - Active Sensor Bearing Ch.3180592→   | 801 838   | 802 839   |
| Alfa 145 1.9 JTD                                | 10/98 → 01  | ABS - Active Sensor Bearing   | 801 972   | 802 839   |
| Alfa 145 2.0 16V                                | 10/98 → 01  | ABS - Active Sensor Bearing Ch.3180592→   | 801 838   | 802 839   |
| Alfa 146  | 94 → -  |   | 04-P197   | -   |
| Alfa 146  | 94 → 98   | <del>ABS</del>  | 800 398   | 802 330   |
| Alfa 146 1.4 i.e., 1.6 i.e., 1.7 i.e., 1.8 i.e. | 99 → 01   | <del>ABS</del>  | 800 398   | 802 330   |
| Alfa 146 1.9 JTD                                | 99 → 01   | <del>ABS</del>  | 801 500   | 802 330   |
| Alfa 146 2.0 16V                                | 99 → 01   | <del>ABS</del>  | 800 398   | 802 330   |
| Alfa 146  | 94 → 01/96  | ABS   | 800 398   | 802 378   |
| Alfa 146  | 02/96 → 10/98   | ABS Ch.→3180591   | 800 398   | 802 315   |
| Alfa 146 1.4 i.e., 1.6 i.e., 1.7 i.e., 1.8 i.e. | 10/98 → 01  | ABS - Active Sensor Bearing Ch.3180592→   | 801 838   | 802 839   |
| Alfa 146 1.9 JTD                                | 10/98 → 01  | ABS - Active Sensor Bearing   | 801 972   | 802 839   |
| Alfa 146 2.0 16V                                | 10/98 → 01  | ABS - Active Sensor Bearing Ch.3180592→   | 801 838   | 802 839   |
| Alfa 147 1.6 TS 16V                             | 01 → 09/04  | ABS - Active Sensor Bearing   | 801 961   | 802 870   |
| Alfa 147 1.6 TS 16V                             | 10/04 → 06  | ABS - Active Sensor Bearing   | 801 961   | -   |
| Alfa 147 1.9 JTD                                | 01 → 09/04  | ABS - Active Sensor Bearing   | 801 961   | 802 870   |
| Alfa 147 1.9 JTD                                | 10/04 → 06  | ABS - Active Sensor Bearing   | 801 961   | -   |
| Alfa 147 2.0 TS 16V                             | 01 → 09/04  | ABS - Active Sensor Bearing   | 801 961   | 802 870   |
| Alfa 147 2.0 TS 16V                             | 10/04 → 06  | ABS - Active Sensor Bearing   | 801 961   | -   |
| Alfa 147 3.2 GTA                                | 03 → 09/04  | ABS - Active Sensor Bearing   | 801 970   | 802 870   |
| Alfa 147 3.2 GTA                                | 10/04 → 06  | ABS - Active Sensor Bearing   | 801 970   | -   |
| Alfa 155 1.6 TS, 1.6 TS 16V                     | 92 → 98   | <del>ABS</del>  | 800 398   | 802 330   |
| Alfa 155 1.9 TD                                 | M1 93 → 97  |   | 04-P197   | -   |
| Alfa 155 1.6 TS, 1.6 TS 16V                     | 92 → 98   | ABS   | 800 398   | 802 378   |
| Alfa 155 1.7 TS, 1.7 TS 16V                     | 92 → 97   | <del>ABS</del>  | 800 398   | 802 330   |
| Alfa 155 1.7 TS, 1.7 TS 16V                     | 92 → 97   | ABS   | 800 398   | 802 378   |









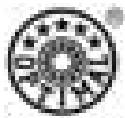





| MODELL/MODEL/MODELE         |               | BEMERKUNGEN/REMARKS/<br>REMARQUES |         |         |
|-----------------------------|---------------|-----------------------------------|---------|---------|
| Alfa 155 1.8 TS, 1.8 TS 16V | 92 → 97       | ABS                               | 800 398 | 802 330 |
| Alfa 155 1.8 TS, 1.8 TS 16V | 92 → 97       | ABS                               | 800 398 | 802 378 |
| Alfa 155 1.9 Turbo Diesel   | 92 → 97       | ABS                               | 800 398 | 802 330 |
| Alfa 155 1.9 Turbo Diesel   | 92 → 97       | ABS                               | 800 398 | 802 378 |
| Alfa 155 2.0 TS, 2.0 TS 16V | 92 → 97       | ABS                               | 800 398 | 802 330 |
| Alfa 155 2.0 TS, 2.0 TS 16V | 92 → 97       | ABS                               | 800 398 | 802 378 |
| Alfa 155 2.0 16V Turbo Q4   | 92 → 97       |                                   | 801 500 | -       |
| Alfa 155 2.5 V6             | 92 → 97       | ABS                               | 801 500 | 802 330 |
| Alfa 155 2.5 V6             | 92 → 97       | ABS                               | 801 500 | 802 378 |
| Alfa 155 2.5 Turbo Diesel   | 92 → 97       | ABS                               | 801 500 | 802 330 |
| Alfa 155 2.5 Turbo Diesel   | 92 → 97       | ABS                               | 801 500 | 802 378 |
| Alfa 156                    | 97 → 09/04    | ABS - Active Sensor Bearing       | 801 970 | 802 870 |
| Alfa 156                    | 10/04 → 06    | ABS - Active Sensor Bearing       | 801 970 | -       |
| Alfa 164 2.0, 2.0 TS        | 87 → 92       | ABS x4                            | 800 400 | 802 368 |
| Alfa 164 2.0, 2.0 TS        | M1,M2 87 → 92 |                                   | 04-P197 | -       |
| Alfa 164 2.0, 2.0 TS        | 87 → 92       | ABS x4                            | 800 400 | 802 370 |
| Alfa 164 2.0, 2.0 TS        | 01/93 → 11/93 | ABS x4 Ch.→0014991                | 800 400 | 802 526 |
| Alfa 164 2.0, 2.0 TS        | 12/93 → 98    | ABS x4 Ch.0014992→                | 801 500 | 802 526 |
| Alfa 164 2.0 Turbo          | 87 → 98       | x5                                | 801 500 | 802 560 |
| Alfa 164 2.0 V6 Turbo       | 91 → 98       | ABS x5                            | 801 500 | 802 335 |
| Alfa 164 2.5 Turbo Diesel   | 87 → 92       | ABS x5                            | 801 500 | 802 560 |
| Alfa 164 2.5 Turbo Diesel   | 87 → 92       | ABS x5                            | 801 500 | 802 562 |
| Alfa 164 2.5 Turbo Diesel   | 93 → 98       | ABS x5                            | 801 500 | 802 335 |
| Alfa 164 3.0 V6             | 87 → 92       | ABS x5                            | 801 500 | 802 560 |
| Alfa 164 3.0 V6             | 87 → 92       | ABS x5                            | 801 500 | 802 562 |
| Alfa 164 3.0 V6             | 93 → 98       | ABS x5                            | 801 500 | 802 335 |
| Alfa 164 3.0 V6 Q4          | 94 → 98       |                                   | 801 500 | 801 500 |
| Alfa 166                    | 98 → 06       | ABS - Active Sensor Bearing       | 801 970 | 802 888 |
| Alfasud                     | 72 → 84       |                                   | 801 588 | 802 652 |
| Alfasud Sprint              | 76 → 89       |                                   | 04-P209 | -       |
| Alfasud Sprint              | 77 → 84       |                                   | 801 588 | 802 652 |
| Alfasud Sprint              | 85 → 87       | Differential brakes               | 801 588 | 802 652 |
| Alfasud Sprint              | 87 → 90       | Hub brakes                        | 801 478 | 802 652 |
| Alfetta                     | 03/80 → 84    |                                   | 801 438 | 802 558 |
| Alfetta                     | 03/80 → 84    |                                   | 801 438 | 802 556 |
| Alfetta GT 1.6, 1.8         | 03/80 → 84    |                                   | 801 438 | 802 558 |
| Alfetta GT 1.6, 1.8         | 03/80 → 84    |                                   | 801 438 | 802 556 |
| Alfetta GTV 2.0             | 03/80 → 84    |                                   | 801 438 | 802 558 |
| Alfetta GTV 2.0             | 03/80 → 84    |                                   | 801 438 | 802 556 |
| Arna                        | 83 → 86       |                                   | 801 478 | 962 776 |
| Giulietta                   | 03/80 → 85    |                                   | 801 438 | 802 558 |
| Giulietta                   | 03/80 → 85    |                                   | 801 438 | 802 556 |
| GT 3 3.0 V6 24V             | 97 → 04/00    |                                   | 801 500 | 802 485 |
| GT 1.8 TS                   | 03 → 09/04    |                                   | 801 970 | 802 870 |
| GT 1.8 TS                   | 10/04 → 06    |                                   | 801 970 | -       |
| GT 1.9 JTD                  | 03 → 09/04    |                                   | 801 970 | 802 870 |
| GT 1.9 JTD                  | 10/04 → 06    |                                   | 801 970 | -       |
| GT 2.0 JTS                  | 03 → 09/04    |                                   | 801 970 | 802 870 |
| GT 2.0 JTS                  | 10/04 → 06    |                                   | 801 970 | -       |
| GT 3.2 GTA                  | 03 → 09/04    |                                   | 801 970 | 802 870 |
| GT 3.2 GTA                  | 10/04 → 06    |                                   | 801 970 | -       |
| GTV 2.0                     | 85 → 87       |                                   | 801 438 | 802 540 |
| GTV 2.0                     | 85 → 87       |                                   | 801 438 | 802 542 |
| GTV 6 2.5                   | 81 → 84       |                                   | 801 438 | 802 558 |

| MODELL/MODEL/MODELE    |  | BEMERKUNGEN/REMARKS/<br>REMARQUES   |  |  |
|------------------------|---|---|---|---|
| GTV 6 2.5              | 81 → 84   |  | 801 438   | 802 556   |
| GTV 6 2.5              | 85 → 87   |  | 801 438   | 802 540   |
| GTV 6 2.5              | 85 → 87   |  | 801 438   | 802 542   |
| GTV II 1.8 16V         | 95 → 04/00  | Ch.→6063040   | 800 398   | 802 485   |
| GTV II 1.8 16V         | 04/00 → 06  | Ch.6063041→ ABS - Active Sensor Bearing   | 801 838   | 802 826   |
| GTV II 2.0 TS 16V      | 95 → 04/00  | Ch.→6063040   | 800 398   | 802 485   |
| GTV II 2.0 TS 16V      | 04/00 → 06  | Ch.6063041→ ABS - Active Sensor Bearing   | 801 972   | 802 826   |
| GTV II 2.0 V6 Turbo    | 95 → 04/00  | Ch.→6063040   | 801 500   | 802 485   |
| GTV II 2.0 V6 Turbo    | 04/00 → 06  | Ch.6063041→ ABS - Active Sensor Bearing   | 801 972   | 802 826   |
| GTV II 2.0 JTS         | 04/03 → 06  | ABS - Active Sensor Bearing   | 801 838   | 802 826   |
| GTV II 3.0 V6 24V      | 95 → 04/00  | Ch.→6063040   | 801 500   | 802 485   |
| GTV II 3.0 V6 24V      | 04/00 → 06  | Ch.6063041→ ABS - Active Sensor Bearing   | 801 972   | 802 826   |
| GTV II 3.2 V6 24V      | 04/03 → 06  | ABS - Active Sensor Bearing   | 801 972   | 802 826   |
| Spider I               | 78 → 93   |   | 801 238   | 802 646   |
| Spider II 1.8 16V      | 95 → 04/00  | Ch.→6063040   | 800 398   | 802 485   |
| Spider II 1.8 16V      | 04/00 → 06  | Ch.6063041→ ABS - Active Sensor Bearing   | 801 838   | 802 826   |
| Spider II 2.0 TS 16V   | 95 → 04/00  | Ch.→6063040   | 800 398   | 802 485   |
| Spider II 2.0 TS 16V   | 04/00 → 06  | Ch.6063041→ ABS - Active Sensor Bearing   | 801 838   | 802 826   |
| Spider II 2.0 V6 Turbo | 95 → 04/00  | Ch.→6063040   | 801 500   | 802 485   |
| Spider II 2.0 V6 Turbo | 04/00 → 06  | Ch.6063041→ ABS - Active Sensor Bearing   | 801 972   | 802 826   |
| Spider II 2.0 JTS      | 04/03 → 06  | ABS - Active Sensor Bearing   | 801 838   | 802 826   |
| Spider II 3.0 V6       | 95 → 04/00  | Ch.→6063040   | 801 500   | 802 485   |
| Spider II 3.0 V6       | 04/00 → 06  | Ch.6063041→ ABS - Active Sensor Bearing   | 801 972   | 802 826   |
| Spider II 3.0 V6 24V   | 95 → 04/00  | Ch.→6063040   | 801 500   | 802 485   |
| Spider II 3.0 V6 24V   | 04/00 → 06  | Ch.6063041→ ABS - Active Sensor Bearing   | 801 972   | 802 826   |
| Spider II 3.2 V6 24V   | 04/03 → 06  | ABS - Active Sensor Bearing   | 801 972   | 802 826   |

| MODELL/MODEL/MODELE |  | BEMERKUNGEN/REMARKS/<br>REMARQUES   |  |  |
|---------------------|---|---|---|---|
| 50                  | 74 → 78   |   | 101 044   | 100 002   |
| 50                  | 74 → 78   |                                      | 04-P107   | -   |
| 100, 100 Avant      | 77 → 84   |   | 04-P171   | -   |
| 100, 100 Avant      | 85 → 86   | 4/108   | 04-P171   | -   |
| 80                  | 74 → 84   | Ch.8242072774→  | 100 014   | 100 002   |
| 100, 100 Avant      | 87 → -  | 4/108, 6 Cyl.   | 04-P171   | -   |
| 80                  | 85 → 04/88  |  Ch.→89J373598                       | 100 014   | 100 002   |
| 100, 100 Avant      | 87 → -  | 4/108, 4 Cyl.   | 04-P171   | -   |
| 80                  | 85 → 04/88  |  Ch.→89J373598                       | 100 014   | 102 008   |
| 100, 100 Avant      | 88 → 91   | 4/108, AT, Ch.44-J-100100 - 44-M-050000   | 04-P171   | -   |
| 80 1.6              | 05/88 → 92  | Ch.→8AN200000   | 100 090   | 100 002   |
| 100, 100 Avant      | 88 → -  | 4/108, 6 Cyl., Ch.-->44-J-200099  | 04-P171   | -   |
| 80 1.6              | 92 → 94   | Ch.8CN000001→   | 100 090   | 102 008   |
| 100, 100 Avant      | 88 → -  | 4/108, 4 Cyl., Ch.-->44-J-200099  | 04-P171   | -   |
| 80 1.8              | 05/88 → 92  |  Ch.→8AN200000                       | 100 090   | 100 002   |
| 100, 100 Avant      | 91 → 94   | 5/112, Ch.4A-M-000001-->  | 04-P157   | -   |
| 80 1.8              | 05/88 → 92  |  Ch.→8AN200000                       | 100 090   | 102 008   |
| 80 1.9              | 05/88 → 92  |  Ch.→8AN200000                       | 100 090   | 100 002   |
| 80 1.9              | 05/88 → 92  |  Ch.→8AN200000                       | 100 090   | 102 008   |
| 80 1.9              | 92 → 94   | Ch.8CN000001→   | 100 090   | 102 008   |
| 80 2.0              | 05/88 → 92  |  Ch.→8AN200000                       | 100 090   | 100 002   |
| 80 2.0              | 05/88 → 92  |  Ch.→8AN200000                      | 100 090   | 102 008   |
| 80 2.0              | 92 → 94   | Ch.8CN000001→   | 100 090   | 102 008   |
| 80 2.2              | 05/88 → 92  | Ch.→8AN200000   | 100 090   | 102 008   |
| 80 2.3              | 125 kW 06/88 → 10/91  |   | 100 099   | 102 008   |
| 80 2.3              | 100 kW 91 → 94  |   | 100 090   | 102 008   |
| 80 2.6 V6           | 91 → 94   |   | 100 099   | 102 008   |
| 80 2.8 V6           | 91 → 94   |   | 100 099   | 102 008   |
| 80 Avant 1.6        | 92 → 96   |   | 100 090   | 102 008   |
| 80 Avant 1.9        | 92 → 96   |   | 100 090   | 102 008   |
| 80 Avant 2.0        | 92 → 96   |   | 100 090   | 102 008   |
| 80 Avant 2.3        | 92 → 96   |   | 100 090   | 102 008   |
| 80 Avant 2.6 V6     | 92 → 96   |   | 100 099   | 102 008   |
| 80 Avant 2.8 V6     | 92 → 96   |   | 100 099   | 102 008   |
| 80 Avant Quattro    | 92 → 95   |  16"                               | 100 099   | 100 098   |
| 80 Quattro          | 83 → 05/88  | Ch.→89J351000   | 100 014   | 100 036   |
| 80 Quattro 1.8      | 05/88 → 09/91   | Ch.89J351001→   | 100 090   | 100 090   |
| 80 Quattro 1.9      | 05/88 → 09/91   | Ch.89J351001→   | 100 090   | 100 090   |
| 80 Quattro 2.0      | 05/88 → 09/91   | Ch.89J351001→   | 100 090   | 100 090   |
| 80 Quattro 2.0      | 10/91 → 94  |   | 100 090   | 100 093   |
| 80 Quattro 2.3      | 100 kW 05/88 → 09/91  |  15" Ch.89J351001→                 | 100 090   | 100 090   |
| 80 Quattro 2.3      | 100 kW 10/91 → 94   |  15"                               | 100 090   | 100 093   |
| 80 Quattro 2.3      | 125 kW 05/88 → 09/91  |  16" Ch.89J351001→                 | 100 099   | 100 090   |
| 80 Quattro 2.3      | 125 kW 10/91 → 94   |  16"                               | 100 099   | 100 093   |
| 80 Quattro 2.6 V6   | 91 → 94   |   | 100 099   | 100 093   |
| 80 Quattro 2.8 V6   | 91 → 94   |   | 100 099   | 100 093   |
| 90                  | 85 → 86   |                                    | 100 014   | 100 002   |
| 80, 90              | 74 → 84   |                                    | 04-P105   | -   |
| 90                  | 85 → 86   |                                    | 100 014   | 102 008   |
| 90                  | 87 → 04/88  |  Ch.→89J373598 <del>Cyl 5 AC</del> | 100 014   | 100 002   |
| 80, 90              | 83 → 91   | Avant Quattro   | -   | 04-P171   |
| 90                  | 87 → 04/88  |  Ch.→89J373598 Cyl 5 AC            | 100 090   | 100 002   |
| 80, 90              | 85 → 87   |  Cyl 4                             | 04-P105   | -   |
| 90                  | 87 → 04/88  |  Ch.→89J373598 <del>Cyl 5 AC</del> | 100 014   | 102 008   |



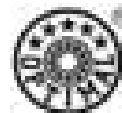

| MODELL/MODEL/MODELE                |                          |  | BEMERKUNGEN/REMARKS/<br>REMARQUES   |  |  |
|------------------------------------|--------------------------|---|---|---|---|
| 80, 90                             |                          | 87 → 89   | Ch.89-J-373599-->   | 04-P175   | -   |
| 90                                 |                          | 87 → 04/88  |  Ch.->89J373598 Cyl 5 AC | 100 090   | 102 008   |
| 80, 90                             |                          | 87 → 89   | Ch.->89-J-373598  | 04-P173   | -   |
| 90 1.6                             |                          | 05/88 → 91  |  Ch.89J373599->          | 100 090   | 100 002   |
| 80, 90                             |                          | 90 → 91   |   | 04-P175   | -   |
| 90 1.6                             |                          | 05/88 → 91  |  Ch.89J373599->          | 100 090   | 102 008   |
| 80, 90                             |                          | 90 → 92   |  Ch.->8AN200000          | -   | 04-P010   |
| Coupe Quattro                      |                          | 85 → 88   |  Cyl 4                   | 04-P105   | -   |
| 90 1.8                             |                          | 05/88 → 91  |  Ch.89J373599->          | 100 090   | 100 002   |
| 80, 90                             |                          | 92 → -  | <del>AAH, ABC, ACZ</del> Ch.8C-N-000001 - 8C-N-300000   | 04-P177   | -   |
| 90 1.8                             |                          | 05/88 → 91  |  Ch.89J373599->          | 100 090   | 102 008   |
| 80, 90                             |                          | 92 → -  | Ch.8A-N-000001 - 8A-N-200000  | 04-P175   | -   |
| 90 2.0                             |                          | 05/88 → 91  |  Ch.89J373599->          | 100 090   | 100 002   |
| 80, 90                             |                          | 93 → 96   | <del>AAH, ABC, ACZ</del>  | 04-P177   | -   |
| 90 2.0                             |                          | 05/88 → 91  |  Ch.89J373599->          | 100 090   | 102 008   |
| 90 2.3                             | 100 kW                   | 88 → 91   |   | 100 090   | 102 008   |
| 90 2.3 20V                         | 125 kW                   | 89 → 91   |   | 100 099   | 102 008   |
| 90 Quattro                         |                          | 85 → 04/87  |   | 100 014   | 100 036   |
| 90 Quattro                         |                          | 04/87 → 05/88   | Ch.->89J351000 <del>AC</del>  | 100 014   | 100 036   |
| 90 Quattro                         |                          | 04/87 → 05/88   | Ch.->89J351000 AC   | 100 090   | 100 036   |
| 90 Quattro 2.0                     |                          | 05/88 → 91  | Ch.89J351001->  | 100 090   | 100 090   |
| 90 Quattro 2.3                     | 100 kW                   | 05/88 → 91  | Ch.89J351001->  | 100 090   | 100 090   |
| 90 Quattro 2.3 20V                 | 125 kW                   | 88 → 91   |   | 100 099   | 100 090   |
| 100                                |                          | 75 → 76   |   | 100 036   | 100 002   |
| 100                                |                          | 77 → 77   |   | 100 036   | 102 008   |
| 100, 100 Avant                     |                          | 78 → 09/85  | Ch.->44G033840  | 100 036   | 102 008   |
| 100, 100 Avant                     |                          | 84 → 87   |                        | 100 056   | 102 008   |
| 100, 100 Avant                     |                          | 09/85 → 87  | Ch.44G033841->44J200099   | 100 056   | 102 008   |
| 100, 100 Avant                     |                          | 88 → 94   | Ch.44J200100-> Man.GBX  | 100 099   | 102 008   |
| 100 Automatic, 100 Avant Automatic |                          | 88 → 90   | Aut.GBX 3-Speed   | 100 056   | 102 008   |
| 100 Automatic, 100 Avant Automatic |                          | 90 → 94   | Aut.GBX 4-Speed   | 100 099   | 102 008   |
| 100 Avant Quattro                  |                          | 84 → 09/85  | Ch.->44G033840  | 100 036   | 100 056   |
| 100 Avant Quattro                  |                          | 09/85 → 87  | Ch.44G033841->44J200099   | 100 056   | 100 056   |
| 100 Avant Quattro                  |                          | 88 → 94   | Ch.44J200100->  | 100 099   | 100 099   |
| A4, A4 Avant                       | AAH,ABC,AC...,AF...,AL.. | 95 → -  | 5/112   | 04-P157   | -   |
| A4, A4 Avant                       | AD...,AEB,AF...,AH...,1Z | 95 → -  | 5/112   | 04-P179   | -   |
| 200                                |                          | 80 → 08/85  | Ch.->44G033840  | 100 036   | 102 008   |
| A6, A6 Avant                       |                          | 95 → 01   |   | 04-P157   | -   |
| 200                                |                          | 09/85 → 01/88   | Ch.44G033841->44J200099   | 100 056   | 102 008   |
| A6, A6 Avant                       | AEB                      | 98 → 01   | A.T.  | 04-P157   | -   |
| 200                                |                          | 02/88 → 91  | Ch.44J200100-> Man.GBX  | 100 099   | 102 008   |
| A6, A6 Avant                       | AEB                      | 98 → 01   | M.T.  | 04-P179   | -   |
| 200                                |                          | 02/88 → 91  | Ch.44J200100-> Aut.GBX  | 100 056   | 102 008   |
| 200 Avant Quattro                  |                          | 85 → 85   |   | 100 036   | 100 056   |
| 200 Avant Quattro                  |                          | 86 → 01/88  | Ch.->44J200099  | 100 056   | 100 056   |
| 200 Avant Quattro                  |                          | 02/88 → 91  | Ch.44J200100->  | 100 099   | 100 098   |
| A2 1.2 TDI                         | (8Z0)                    | 01 → 08/05  | ABS - Active Sensor Bearing   | 101 029   | 102 069   |
| A2 1.4, 1.4 TDI                    | (8Z0)                    | 00 → 08/05  | <del>ABS</del>  | 101 027   | 102 015   |
| A2 1.4, 1.4 TDI                    | (8Z0)                    | 00 → 08/05  | ABS - Active Sensor Bearing   | 101 027   | 102 077   |
| A2 1.6 FSI                         | (8Z0)                    | 02 → 08/05  | <del>ABS</del>  | 101 027   | 102 015   |
| A2 1.6 FSI                         | (8Z0)                    | 02 → 08/05  | ABS - Active Sensor Bearing   | 101 027   | 102 077   |
| Quattro                            |                          | 88 → 91   | 4 Cyl.  | 04-P171   | -   |
| A3                                 | (8L1)                    | 96 → 05/03  |   | 101 113   | 102 115   |
| A3                                 | (8P1)                    | 05/03 → 12/03   | Ch.->8P-4-162000  | 101 017   | 102 019   |









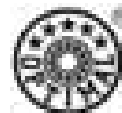





| MODELL/MODEL/MODELE         |            | BEMERKUNGEN/REMARKS/<br>REMARQUES |                        |        |                 |
|-----------------------------|------------|-----------------------------------|------------------------|--------|-----------------|
| A3                          | (8P1, 8PA) | 12/03 → 05                        | Ch.8P-4-162001→        | 280 mm | 101 699 102 213 |
| A3                          | (8P1, 8PA) | 12/03 → 05                        | Ch.8P-4-162001→        | 280 mm | 101 017 102 213 |
| A3 Quattro                  | (8L1)      | 99 → 05/03                        |                        |        | 101 113 101 113 |
| A3 Quattro                  | (8P1)      | 05/03 → 06                        |                        |        | 101 017 101 017 |
| A4 1.6                      | (8D2, B5)  | 95 → 97                           | Ch.→8DV152676          |        | 100 091 102 008 |
| A4 1.6                      | (8D2, B5)  | 97 → 00                           | Ch.8DV152677→8E1000000 |        | 100 091 102 055 |
| A4 1.8, 1.8 T 110 kW        | (8D2, B5)  | 95 → 97                           | Ch.→8DV152676          |        | 100 091 102 008 |
| A4 1.8, 1.8 T 110 kW        | (8D2, B5)  | 97 → 00                           | Ch.8DV152677→8E1000000 |        | 100 091 102 055 |
| A4 1.8 T 132kW              | (8D2, B5)  | 97 → 00                           | Ch.→8E1000000          |        | 100 098 102 055 |
| A4 1.9 TDI                  | (8D2, B5)  | 95 → 97                           | Ch.→8DV152676          |        | 100 091 102 008 |
| A4 1.9 TDI                  | (8D2, B5)  | 97 → 00                           | Ch.8DV152677→8E1000000 |        | 100 091 102 055 |
| A4 2.4                      | (8D2, B5)  | 95 → 96                           | Ch.→8DT160955          |        | 101 111 102 008 |
| A4 2.4                      | (8D2, B5)  | 96 → 97                           | Ch.8DT160956→8DV152676 |        | 100 098 102 008 |
| A4 2.4                      | (8D2, B5)  | 97 → 00                           | Ch.8DV152677→8E1000000 |        | 100 098 102 055 |
| A4 2.5 TDI                  | (8D2, B5)  | 96 → 97                           | Ch.→8DV152676          |        | 100 098 102 008 |
| A4 2.5 TDI                  | (8D2, B5)  | 97 → 00                           | Ch.8DV152677→8E1000000 |        | 100 098 102 055 |
| A4 2.6, 2.8                 | (8D2, B5)  | 95 → 96                           | Ch.→8DT160955          |        | 101 111 102 008 |
| A4 2.6, 2.8                 | (8D2, B5)  | 96 → 97                           | Ch.8DT160956→8DV152676 |        | 100 098 102 008 |
| A4 2.6, 2.8                 | (8D2, B5)  | 97 → 00                           | Ch.8DV152677→8E1000000 |        | 100 098 102 055 |
| A4                          | (8E2, B6)  | 00 → 10/04                        | Ch.8E1000001→          |        | 100 053 102 071 |
| A4                          | (8EC)      | 11/04 → 06                        |                        |        | 100 053 -       |
| A4 Avant 1.6                | (8D5, B5)  | 95 → 97                           | Ch.→8DV152676          |        | 100 091 102 008 |
| A4 Avant 1.6                | (8D5, B5)  | 97 → 01                           | Ch.8DV152677→8E1000000 |        | 100 091 102 055 |
| A4 Avant 1.8, 1.8 T 110 kW  | (8D5, B5)  | 95 → 97                           | Ch.→8DV152676          |        | 100 091 102 008 |
| A4 Avant 1.8, 1.8 T 110 kW  | (8D5, B5)  | 97 → 01                           | Ch.8DV152677→8E1000000 |        | 100 091 102 055 |
| A4 Avant 1.8 T 132kW        | (8D5, B5)  | 97 → 01                           | Ch.→8E1000000          |        | 100 098 102 055 |
| A4 Avant 1.9 TDI            | (8D5, B5)  | 95 → 97                           | Ch.→8DV152676          |        | 100 091 102 008 |
| A4 Avant 1.9 TDI            | (8D5, B5)  | 97 → 01                           | Ch.8DV152677→8E1000000 |        | 100 091 102 055 |
| A4 Avant 2.4                | (8D5, B5)  | 95 → 96                           | Ch.→8DT160955          |        | 101 111 102 008 |
| A4 Avant 2.4                | (8D5, B5)  | 96 → 97                           | Ch.8DT160956→8DV152676 |        | 100 098 102 008 |
| A4 Avant 2.4                | (8D5, B5)  | 97 → 01                           | Ch.8DV152677→8E1000000 |        | 100 098 102 055 |
| A4 Avant 2.5 TDI            | (8D5, B5)  | 96 → 97                           | Ch.→8DV152676          |        | 100 098 102 008 |
| A4 Avant 2.5 TDI            | (8D5, B5)  | 97 → 01                           | Ch.8DV152677→8E1000000 |        | 100 098 102 055 |
| A4 Avant 2.6, 2.8           | (8D5, B5)  | 95 → 96                           | Ch.→8DT160955          |        | 101 111 102 008 |
| A4 Avant 2.6, 2.8           | (8D5, B5)  | 96 → 97                           | Ch.8DT160956→8DV152676 |        | 100 098 102 008 |
| A4 Avant 2.6, 2.8           | (8D5, B5)  | 97 → 01                           | Ch.8DV152677→8E1000000 |        | 100 098 102 055 |
| A4 Avant                    | (8E5, B6)  | 00 → 10/04                        | Ch.8E1000001→          |        | 100 053 102 071 |
| A4 Avant                    | (8ED)      | 11/04 → 06                        |                        |        | 100 053 -       |
| A4 Avant Quattro 1.8        | (8D5, B5)  | 95 → 01                           | Ch.→8D1200000          |        | 100 091 100 093 |
| A4 Avant Quattro 1.8 132 kW | (8D5, B5)  | 96 → 01                           | Ch.8DT160956→          |        | 100 098 100 093 |
| A4 Avant Quattro 1.9 TDI    | (8D5, B5)  | 95 → 01                           | Ch.→8D1200000          |        | 100 091 100 093 |
| A4 Avant Quattro 2.4        | (8D5, B5)  | 96 → 01                           | Ch.→8D1200000          |        | 100 098 100 093 |
| A4 Avant Quattro 2.5 TDI    | (8D5, B5)  | 96 → 01                           | Ch.→8D1200000          |        | 100 098 100 093 |
| A4 Avant Quattro 2.6        | (8D5, B5)  | 95 → 96                           | Ch.→8DT160955          |        | 101 111 100 093 |
| A4 Avant Quattro 2.6        | (8D5, B5)  | 96 → 01                           | Ch.8DT160956→          |        | 100 098 100 093 |
| A4 Avant Quattro 2.7        | (8D5, B5)  | 96 → 01                           | Ch.→8D1200000          |        | 100 098 100 093 |
| A4 Avant Quattro 2.8 128 kW | (8D5, B5)  | 95 → 96                           | Ch.→8DT160955          |        | 101 111 100 093 |
| A4 Avant Quattro 2.8 128 kW | (8D5, B5)  | 96 → 01                           | Ch.8DT160956→8D1200000 |        | 100 098 100 093 |
| A4 Avant Quattro 2.8 142 kW | (8D5, B5)  | 96 → 01                           | Ch.→8D1200000          |        | 100 098 100 093 |
| A4 Avant Quattro            | (8E5, B6)  | 00 → 10/04                        | Ch.8E1000001→          |        | 100 053 102 097 |
| A4 Cabrio Quattro           | (8H7)      | 03 → 10/04                        |                        |        | 100 053 102 097 |
| A4 Cabrio                   | (8H7)      | 03 → 10/04                        |                        |        | 100 053 102 071 |
| A4 Quattro 1.8              | (8D2, B5)  | 95 → 00                           | Ch.→8D1200000          |        | 100 091 100 093 |
| A4 Quattro 1.8 132 kW       | (8D2, B5)  | 96 → 00                           | Ch.8DT160956→          |        | 100 098 100 093 |





| MODELL/MODEL/MODELE           |           |               |  | BEMERKUNGEN/REMARKS/<br>REMARQUES |  |  |
|-------------------------------|-----------|---------------|---|-----------------------------------|---|---|
| A4 Quattro 1.9 TDI            | (8D2, B5) | 95 → 00       | Ch.→8D1200000   |                                   | 100 091   | 100 093   |
| A4 Quattro 2.4                | (8D2, B5) | 96 → 00       | Ch.→8D1200000   |                                   | 100 098   | 100 093   |
| A4 Quattro 2.5 TDI            | (8D2, B5) | 96 → 00       | Ch.→8D1200000   |                                   | 100 098   | 100 093   |
| A4 Quattro 2.6                | (8D2, B5) | 95 → 96       | Ch.→8DT160955   |                                   | 101 111   | 100 093   |
| A4 Quattro 2.6                | (8D2, B5) | 96 → 00       | Ch.8DT160956→   |                                   | 100 098   | 100 093   |
| A4 Quattro 2.7                | (8D2, B5) | 96 → 00       | Ch.→8D1200000   |                                   | 100 098   | 100 093   |
| A4 Quattro 2.8 128 kW         | (8D2, B5) | 95 → 96       | Ch.→8DT160955   |                                   | 101 111   | 100 093   |
| A4 Quattro 2.8 128 kW         | (8D2, B5) | 96 → 00       | Ch.8DT160956→8D1200000  |                                   | 100 098   | 100 093   |
| A4 Quattro 2.8 142 kW         | (8D2, B5) | 96 → 00       | Ch.→8D1200000   |                                   | 100 098   | 100 093   |
| A4 Quattro                    | (8E2, B6) | 00 → 10/04    | Ch.8E1000001→   |                                   | 100 053   | 102 097   |
| A6                            | (4A, C4)  | 94 → 97       | Ch.→4AV120000   |                                   | 100 098   | 102 008   |
| A6 1.8                        | (4B, C5)  | 98 → 04/04    | Ch.4BW000001→   |                                   | 100 091   | 102 011   |
| A6 1.8 T 110 kW               | (4B, C5)  | 97 → 04/04    | Ch.4BW000001→ Man.GBX   |                                   | 100 091   | 102 011   |
| A6 1.8 T 110 kW               | (4B, C5)  | 97 → 04/04    | Ch.4BW000001→ Aut.GBX   |                                   | 100 098   | 102 011   |
| A6 1.8 T 132 kW               | (4B, C5)  | 97 → 04/04    | Ch.4BW000001→   |                                   | 100 098   | 102 011   |
| A6 1.9 TDI                    | (4B, C5)  | 97 → 04/04    | Ch.4BW000001→   |                                   | 100 098   | 102 011   |
| A6 2.0                        | (4B, C5)  | 01 → 04/04    |   |                                   | 100 053   | 102 097   |
| A6 2.4                        | (4B, C5)  | 97 → 04/04    | Ch.4BW000001→   |                                   | 100 098   | 102 011   |
| A6 2.5 TDI                    | (4B, C5)  | 97 → 04/04    | Ch.4BW000001→   |                                   | 100 098   | 102 011   |
| A6 2.7 T                      | (4B, C5)  | 99 → 04/04    | Ch.4BW000001→   |                                   | 100 098   | 102 011   |
| A6 2.8                        | (4B, C5)  | 97 → 04/04    | Ch.4BW000001→   |                                   | 100 098   | 102 011   |
| A6 3.0                        | (4B, C5)  | 01 → 04/04    |   |                                   | 100 098   | 102 011   |
| A6 3.7                        | (4B, C5)  | 99 → 04/04    |   |                                   | 100 098   | 102 011   |
| A6                            | (4F2)     | 05/04 → 12/04 |   |                                   | 100 098   | -   |
| A6 Allroad Quattro            | (4BH)     | 00 → 04/04    |   |                                   | 100 098   | 100 098   |
| A6 Allroad                    | (4BH)     | 00 → 04/04    |   |                                   | 100 098   | 100 098   |
| A6 Avant                      | (4A, C4)  | 95 → 97       | Ch.→4AV120000   |                                   | 100 098   | 102 008   |
| A6 Avant 1.8                  | (4B, C5)  | 97 → 04/04    | Ch.4BW000001→   |                                   | 100 098   | 102 011   |
| A6 Avant 1.8 T 110 kW         | (4B, C5)  | 97 → 04/04    | Ch.4BW000001→ Man.GBX   |                                   | 100 091   | 102 011   |
| A6 Avant 1.8 T 110 kW         | (4B, C5)  | 97 → 04/04    | Ch.4BW000001→ Aut.GBX   |                                   | 100 098   | 102 011   |
| A6 Avant 1.8 T 132 kW         | (4B, C5)  | 97 → 04/04    | Ch.4BW000001→   |                                   | 100 098   | 102 011   |
| A6 Avant 1.9 TDI              | (4B, C5)  | 97 → 04/04    | Ch.4BW000001→   |                                   | 100 098   | 102 011   |
| A6 Avant 2.0                  | (4B, C5)  | 01 → 04/04    |   |                                   | 100 098   | 102 011   |
| A6 Avant 2.4                  | (4B, C5)  | 97 → 04/04    | Ch.4BW000001→   |                                   | 100 098   | 102 011   |
| A6 Avant 2.5 TDI              | (4B, C5)  | 97 → 04/04    | Ch.4BW000001→   |                                   | 100 098   | 102 011   |
| A6 Avant 2.7 T                | (4B, C5)  | 97 → 04/04    | Ch.4BW000001→   |                                   | 100 098   | 102 011   |
| A6 Avant 2.8                  | (4B, C5)  | 97 → 04/04    | Ch.4BW000001→   |                                   | 100 098   | 102 011   |
| A6 Avant 3.0                  | (4B, C5)  | 01 → 04/04    |   |                                   | 100 098   | 102 011   |
| A6 Avant 3.7                  | (4B, C5)  | 99 → 04/04    |   |                                   | 100 098   | 102 011   |
| A6 Avant 4.2 V8               | (4B, C5)  | 98 → 04/04    |   |                                   | 100 053   | 100 053   |
| A6 Avant Quattro              | (4A, C4)  | 94 → 97       | Ch.→4AV150000   |                                   | 100 098   | 100 098   |
| A6 Avant Quattro 1.8 T 110 kW | (4B, C5)  | 97 → 04/04    | Ch.4BW000001→ Man.GBX   |                                   | 100 091   | 100 098   |
| A6 Avant Quattro 1.8 T 132 kW | (4B, C5)  | 97 → 04/04    | Ch.4BW000001→   |                                   | 100 098   | 100 098   |
| A6 Avant Quattro 2.4          | (4B, C5)  | 97 → 04/04    | Ch.4BW000001→   |                                   | 100 098   | 100 098   |
| A6 Avant Quattro 2.5 TDI      | (4B, C5)  | 97 → 04/04    | Ch.4BW000001→   |                                   | 100 098   | 100 098   |
| A6 Avant Quattro 2.7 T        | (4B, C5)  | 97 → 04/04    | Ch.4BW000001→   |                                   | 100 098   | 100 098   |
| A6 Avant Quattro 2.8          | (4B, C5)  | 97 → 04/04    | Ch.4BW000001→   |                                   | 100 098   | 100 098   |
| A6 Avant Quattro 3.0          | (4B, C5)  | 01 → 04/04    |   |                                   | 100 098   | 100 098   |
| A6 Avant Quattro 3.7          | (4B, C5)  | 99 → 04/04    |   |                                   | 100 098   | 100 098   |
| A6 Avant Quattro 4.2 V8       | (4B, C5)  | 98 → 04/04    |   |                                   | 100 053   | 100 053   |
| A6 Quattro                    | (4A, C4)  | 94 → 97       | Ch.→4AV150000   |                                   | 100 098   | 100 098   |
| A6 Quattro 1.8 T 110 kW       | (4B, C5)  | 97 → 04/04    | Ch.4BW000001→ Man.GBX   |                                   | 100 091   | 102 041   |
| A6 Quattro 1.8 T 132 kW       | (4B, C5)  | 97 → 04/04    | Ch.4BW000001→   |                                   | 100 098   | 102 041   |
| A6 Quattro 2.4                | (4B, C5)  | 97 → 04/04    | Ch.4BW000001→   |                                   | 100 098   | 102 041   |





| MODELL/MODEL/MODELE      |            |  | BEMERKUNGEN/REMARKS/<br>REMARQUES   |  |  |
|--------------------------|------------|---|---|---|---|
| A6 Quattro 2.5 TDI       | (4B, C5)   | 97 → 04/04  | Ch.4BW000001→   | 100 098   | 102 041   |
| A6 Quattro 2.7 T         | (4B, C5)   | 97 → 04/04  | Ch.4BW000001→   | 100 098   | 102 041   |
| A6 Quattro 2.8           | (4B, C5)   | 97 → 04/04  | Ch.4BW000001→   | 100 098   | 102 041   |
| A6 Quattro 3.0           | (4B, C5)   | 01 → 04/04  |   | 100 053   | 102 097   |
| A6 Quattro 3.7           | (4B, C5)   | 99 → 04/04  | Ch.4BW000001→   | 100 053   | 102 041   |
| A6 Quattro 4.2 V8        | (4B, C5)   | 98 → 04/04  |   | 100 053   | 100 053   |
| A8                       | (4D2, 4D8) | 94 → 96   | Ch.→4DT007000   | 101 111   | 100 098   |
| A8                       | (4D2, 4D8) | 96 → 98   | Ch.4DT007001→4DX005000  | 101 111   | 100 098   |
| A8                       | (4D2, 4D8) | 98 → 09/02  | Ch.4DX005001→   | 100 053   | 100 053   |
| A8                       | (4E_)      | 10/02 → 04/04   |   | 100 053   | -   |
| A8 Quattro               | (4D2, 4D8) | 94 → 96   | Ch.→4DT007000   | 101 111   | 100 098   |
| A8 Quattro               | (4D2, 4D8) | 96 → 98   | Ch.4DT007001→4DX005000  | 100 098   | 100 098   |
| A8 Quattro               | (4D2, 4D8) | 98 → 09/02  | Ch.4DX005001→4E3020000  | 100 053   | 100 053   |
| A8 Quattro               | (4E_)      | 10/02 → 05/03   |   | 100 053   | 100 053   |
| Allroad                  |            | 07/02 → 04/04   |   | 100 098   | 100 098   |
| Allroad Quattro          |            | 05/00 → 04/04   |   | 100 098   | 100 098   |
| Cabriolet 1.8            |            | 91 → 97   | Ch.→8GV004799   | 100 090   | 102 008   |
| Cabriolet 1.8            |            | 97 → 00   | Ch.8GV004800→   | 100 090   | 102 055   |
| Cabriolet 1.9 TDI        |            | 91 → 97   | Ch.→8GV004799   | 100 090   | 102 008   |
| Cabriolet 1.9 TDI        |            | 97 → 00   | Ch.8GV004800→   | 100 090   | 102 055   |
| Cabriolet 2.0            |            | 91 → 97   | Ch.→8GV004799   | 100 090   | 102 008   |
| Cabriolet 2.0            |            | 97 → 00   | Ch.8GV004800→   | 100 090   | 102 055   |
| Cabriolet 2.3            |            | 91 → 97   | Ch.→8GV004799   | 100 090   | 102 008   |
| Cabriolet 2.3            |            | 97 → 00   | Ch.8GV004800→   | 100 090   | 102 055   |
| Cabriolet 2.6 V6         |            | 92 → 97   | Ch.→8GV004799   | 100 099   | 102 008   |
| Cabriolet 2.6 V6         |            | 97 → 00   | Ch.8GV004800→   | 100 099   | 102 055   |
| Cabriolet 2.8 V6         |            | 92 → 97   | Ch.→8GV004799   | 100 099   | 102 008   |
| Cabriolet 2.8 V6         |            | 97 → 00   | Ch.8GV004800→   | 100 099   | 102 055   |
| Coupé 1.8, 2.0, 2.23     |            | 81 → 84   |   | 100 014   | 100 002   |
| Coupé 1.8, 2.0, 2.23     |            | 85 → 88   |      | 100 014   | 100 002   |
| Coupé 1.8, 2.0, 2.23     |            | 85 → 88   |      | 100 014   | 102 008   |
| Coupé 1.8, 2.0, 2.23     |            | 89 → 96   |   | 100 090   | 102 008   |
| Coupé 2.3 V5 10V         |            | 81 → 84   |   | 100 014   | 100 002   |
| Coupé 2.3 V5 10V         |            | 85 → 88   |      | 100 014   | 100 002   |
| Coupé 2.3 V5 10V         |            | 85 → 88   |      | 100 014   | 102 008   |
| Coupé 2.3 V5 10V         |            | 89 → 96   |   | 100 090   | 102 008   |
| Coupé 2.3 V5 20V         |            | 89 → 91   |   | 100 099   | 102 008   |
| Coupé 2.6 V6             |            | 91 → 96   |   | 100 099   | 102 008   |
| Coupé 2.8 V6             |            | 91 → 96   |   | 100 099   | 102 008   |
| Coupé Quattro            |            | 85 → 88   |   | 100 014   | 100 036   |
| Coupé Quattro 2.0        |            | 89 → 91   |   | 100 090   | 100 090   |
| Coupé Quattro 2.2        |            | 89 → 96   |   | 100 099   | 100 090   |
| Coupé Quattro 2.23       |            | 89 → 91   |   | 100 090   | 100 090   |
| Coupé Quattro 2.3 V5 10V |            | 89 → 94   |  15" | 100 090   | 100 090   |
| Coupé Quattro 2.3 V5 10V |            | 89 → 94   |  16" | 100 099   | 100 099   |
| Coupé Quattro 2.3 V5 20V |            | 89 → 96   |   | 100 099   | 100 090   |
| Coupé Quattro 2.6 V6     |            | 89 → 96   |   | 100 099   | 100 090   |
| Coupé Quattro 2.8 V6     |            | 89 → 96   |   | 100 099   | 100 090   |
| Quattro                  |            | 80 → 07/85  |   | 100 036   | 100 036   |
| Quattro                  |            | 08/85 → 91  |   | 100 056   | 100 036   |
| RS2 Quattro              |            | 94 → 95   |   | 100 098   | 100 098   |
| RS4 Quattro              |            | 00 → 01   |   | 100 053   | 100 091   |
| RS6 Quattro              |            | 02 → 04   |   | 100 053   | 100 098   |
| S2 Quattro               |            | 92 → 96   |   | 100 099   | 100 099   |

| MODELL/MODEL/MODELE  |  | BEMERKUNGEN/REMARKS/<br>REMARQUES |  |  |
|----------------------|---|-----------------------------------|---|---|
| S3 Quattro           | 99 → 03   |                                   | 101 113   | 101 113   |
| S3 Quattro (8PA)     | 09/04 → 07  |                                   | 101 017   | 101 017   |
| S4 Quattro (4A, C4)  | 91 → 94   |                                   | 100 099   | 100 099   |
| S4 Quattro (8D2, B5) | 97 → 01   |                                   | 100 099   | 100 093   |
| S4 Quattro (8E2, B6) | 03 → 04   |                                   | 100 053   | 102 097   |
| S4 Avant Quattro     | 97 → 99   | Ch.->8DX199999                    | 100 099   | 100 093   |
| S4 Avant Quattro     | 99 → 09/01  | Ch.8DX200001->                    | 100 053   | 100 093   |
| S6 Quattro           | 94 → 97   |                                   | 100 099   | 100 099   |
| S6 Quattro           | 99 → 04   |                                   | 100 053   | 100 053   |
| S8 Quattro           | 97 → 01/99  | Ch.->4DX005000                    | 100 099   | 100 099   |
| S8 Quattro           | 01/99 → 02  | Ch.4DX005001->                    | 100 053   | 100 053   |
| Sport Quattro        | 84 → 91   |                                   | 100 056   | 100 056   |
| TT                   | 98 → 04   |                                   | 101 113   | 102 115   |
| TT (8J3)             | 10/06 → 07  |                                   | 101 017   | -   |
| TT Quattro           | 98 → 04   |                                   | 101 113   | 101 113   |
| V8 Quattro           | 88 → 94   |                                   | 100 099   | 100 099   |



| MODELL/MODEL/MODELE |  | BEMERKUNGEN/REMARKS/<br>REMARQUES |  |  |
|---------------------|---|-----------------------------------|---|---|
| A112                | 80 → 05/84  |                                   | 800 408   | 802 318   |
| A112 E              | 80 → 05/84  |                                   | 800 408   | 802 318   |
| A112 Abarth         | 80 → 05/84  |                                   | 800 408   | 802 318   |
| A112                | 06/84 → 86  |                                   | 800 408   | 802 324   |
| Y10                 | 85 → 92   |                                   | 801 342   | 802 324   |
| Y10 4x4             | 87 → 92   |                                   | 801 342   | 802 444   |

| MODELL/MODEL/MODELE |     |  | BEMERKUNGEN/REMARKS/<br>REMARQUES       |  |  |  |
|---------------------|-----|---|---|--|---|---|
| 118 i               | E87 | 04 → 06   |   |  | 501 513   | 502 629   |
| 118 d               | E87 | 04 → 06   |   |  | 501 513   | 502 629   |
| 120 i               | E87 | 04 → 06   |   |  | 501 513   | 502 629   |
| 130 i               | E87 | 05 → 06   |   |  | 501 513   | -   |
| 120 d               | E87 | 04 → 06   |   |  | 501 513   | -   |
| 315                 | E21 | 80 → 83   |   |  | 501 194   | 502 134   |
| 316                 | E21 | 75 → 83   |   |  | 501 194   | 502 134   |
| 316                 | E30 | 82 → 91   | <del>ABS</del>                          |  | 501 088   | 502 068   |
| 316                 | E30 | 82 → 09/85  | ABS                                     |  | 501 112   | 502 068   |
| 316                 | E30 | 10/85 → 91  | ABS                                     |  | 501 112   | 502 072   |
| 316 i/5 Touring     | E30 | 91 → 94   | <del>ABS</del>                          |  | 501 088   | 502 068   |
| 316 i/5 Touring     | E30 | 91 → 94   | ABS                                     |  | 501 112   | 502 072   |
| 316 i               | E36 | 90 → 94   | Mot.M40 <del>ABS</del>                  |  | 501 136   | 502 138   |
| 316 i               | E36 | 90 → 91   | Mot.M40 ABS                             |  | 501 136   | 502 148   |
| 316 i               | E36 | 92 → 94   | Mot.M40 ABS                             |  | 501 136   | 502 138   |
| 316 i               | E36 | 93 → 98   | Mot.M43 <del>ASC+T</del>                |  | 501 136   | 502 138   |
| 316 i               | E36 | 93 → 98   | Mot.M43 ASC+T                           |  | 501 136   | 502 148   |
| 316 i Coupé         | E36 | 93 → 99   | <del>ASC+T</del>                        |  | 501 136   | 502 138   |
| 316 i Coupé         | E36 | 93 → 99   | ASC+T                                   |  | 501 136   | 502 148   |
| 316 Compact         | E36 | 93 → 99   |   |  | 501 136   | 502 125   |
| 316 i Touring       | E36 | 96 → 99   |   |  | 501 136   | 502 148   |
| 316 i               | E46 | 98 → 04   |   |  | 501 136   | 502 148   |
| 316 i Touring       | E46 | 02 → 04   |   |  | 501 136   | 502 148   |
| 316 Ci Coupé        | E46 | 98 → 04   |   |  | 501 136   | 502 148   |
| 316 ti Compact      | E46 | 01 → 04   |   |  | 501 136   | 502 148   |
| 318                 | E21 | 75 → 83   |   |  | 501 194   | 502 134   |
| 318 i               | E30 | 82 → 87   | <del>ABS</del>                          |  | 501 088   | 502 068   |
| 318 i               | E30 | 82 → 87   | ABS                                     |  | 501 112   | 502 072   |
| 318                 | E30 | 87 → 91   | <del>ABS</del> Mot.M40                  |  | 501 088   | 502 068   |
| 318                 | E30 | 87 → 91   | ABS Mot.M40                             |  | 501 112   | 502 072   |
| 318 is              | E30 | 89 → 91   | <del>ABS</del>                          |  | 501 088   | 502 072   |
| 318 is              | E30 | 89 → 91   | ABS                                     |  | 501 112   | 502 072   |
| 318 ic Cabriolet    | E30 | 90 → 93   | <del>ABS</del>                          |  | 501 088   | 502 072   |
| 318 ic Cabriolet    | E30 | 90 → 93   | ABS                                     |  | 501 112   | 502 072   |
| 318 i/5 Touring     | E30 | 89 → 94   | <del>ABS</del>                          |  | 501 088   | 502 072   |
| 318 i/5 Touring     | E30 | 89 → 94   | ABS                                     |  | 501 112   | 502 072   |
| 318 i               | E36 | 89 → 94   | Mot.M40 <del>ABS</del>                  |  | 501 136   | 502 138   |
| 318 i               | E36 | 89 → 91   | Mot.M40 ABS                             |  | 501 136   | 502 148   |
| 318 i               | E36 | 92 → 94   | Mot.M40 ABS                             |  | 501 136   | 502 138   |
| 318 i               | E36 | 93 → 98   | Mot.M43 <del>ABS</del> <del>ASC+T</del> |  | 501 136   | 502 138   |
| 318 i               | E36 | 93 → 98   | Mot.M43 ABS ASC+T                       |  | 501 136   | 502 148   |
| 318 is              | E36 | 91 → 99   |   |  | 501 136   | 502 148   |
| 318 i Cabriolet     | E36 | 92 → 99   |   |  | 501 136   | 502 148   |
| 318 i Compact       | E36 | 94 → 99   |   |  | 501 136   | 502 125   |
| 318 i Touring       | E36 | 95 → 99   |   |  | 501 136   | 502 148   |
| 318 tds             | E36 | 94 → 99   |   |  | 501 136   | 502 148   |
| 318 tds Compact     | E36 | 95 → 99   |   |  | 501 136   | 502 125   |
| 318 tds Touring     | E36 | 94 → 99   |   |  | 501 136   | 502 148   |
| 318 i               | E46 | 97 → 05   |   |  | 501 136   | 502 148   |
| 318 i Touring       | E46 | 99 → 05   |   |  | 501 136   | 502 148   |
| 318 Ci Coupé        | E46 | 99 → 05   |   |  | 501 136   | 502 148   |
| 318 Ci Cabriolet    | E46 | 01 → 05   |   |  | 501 136   | 502 148   |
| 318 d               | E46 | 01 → 05   |   |  | 501 136   | 502 148   |
| 318 td Compact      | E46 | 03 → 05   |   |  | 501 136   | 502 148   |





## BEMERKUNGEN/REMARKS/ REMARQUES



| MODELL/MODEL/MODELE |     |       |   |       |                |                 |
|---------------------|-----|-------|---|-------|----------------|-----------------|
| 318 ti Compact      | E46 | 01    | → | 05    |                | 501 136 502 148 |
| 318 i               | E90 | 09/05 | → | 06    |                | 501 513 502 629 |
| 318 i Touring       | E91 | 01/06 | → | 12/06 |                | 501 513 -       |
| 318 d               | E90 | 09/05 | → | 06    |                | 501 513 502 629 |
| 318 d Touring       | E91 | 01/06 | → | 12/06 |                | 501 513 -       |
| 320/6               | E21 | 77    | → | 82    |                | 501 184 -       |
| 320 i               | E30 | 82    | → | 91    | <del>ABS</del> | 501 088 502 068 |
| 320 i               | E30 | 82    | → | 09/85 | ABS            | 501 112 502 068 |
| 320 i               | E30 | 10/85 | → | 91    | ABS            | 501 112 502 072 |
| 320 is              | E30 | 87    | → | 90    |                | 501 112 502 072 |
| 320 ix              | E30 | 85    | → | 91    |                | - 502 072       |
| 320 i/5 Touring     | E30 | 88    | → | 91    | <del>ABS</del> | 501 088 502 072 |
| 320 i/5 Touring     | E30 | 88    | → | 91    | ABS            | 501 112 502 072 |
| 320 ic Cabriolet    | E30 | 83    | → | 09/85 |                | 501 088 502 068 |
| 320 ic Cabriolet    | E30 | 10/85 | → | 93    | ABS            | 501 112 502 072 |
| 320 i               | E36 | 90    | → | 99    |                | 501 136 502 148 |
| 320 i Cabriolet     | E36 | 90    | → | 99    |                | 501 136 502 148 |
| 320 i Coupé         | E36 | 92    | → | 99    |                | 501 136 502 148 |
| 320 i Touring       | E36 | 95    | → | 99    |                | 501 136 502 148 |
| 320 i               | E46 | 98    | → | 05    |                | 501 136 502 148 |
| 320 i Touring       | E46 | 00    | → | 05    |                | 501 136 502 148 |
| 320 Ci Cabriolet    | E46 | 00    | → | 05    |                | 501 136 502 148 |
| 320 Ci Coupé        | E46 | 99    | → | 05    |                | 501 136 502 148 |
| 320 Cd Coupé        | E46 | 03    | → | 05    |                | 501 136 502 148 |
| 320 d               | E46 | 98    | → | 05    |                | 501 136 502 148 |
| 320 d Touring       | E46 | 00    | → | 05    |                | 501 136 502 148 |
| 320 td Compact      | E46 | 01    | → | 05    |                | 501 136 502 148 |
| 320 i               | E90 | 01/05 | → | 06    |                | 501 513 502 629 |
| 320 i Touring       | E91 | 01/05 | → | 06    |                | 501 513 502 629 |
| 320 d               | E90 | 01/05 | → | 06    |                | 501 513 502 629 |
| 320 d Touring       | E91 | 01/05 | → | 06    |                | 501 513 502 629 |
| 323 i               | E21 | 77    | → | 82    |                | 501 184 -       |
| 323 i               | E30 | 81    | → | 09/85 | <del>ABS</del> | 501 088 502 068 |
| 323 i               | E30 | 81    | → | 09/85 | ABS            | 501 112 502 068 |
| 323 i               | E30 | 10/85 | → | 86    | <del>ABS</del> | 501 088 502 072 |
| 323 i               | E30 | 10/85 | → | 86    | ABS            | 501 112 502 072 |
| 323 i               | E36 | 94    | → | 99    |                | 501 136 502 148 |
| 323 ti Compact      | E36 | 97    | → | 00    |                | 501 136 502 072 |
| 323 i               | E46 | 97    | → | 04    |                | 501 136 502 148 |
| 323 Ci Coupé        | E46 | 99    | → | 04    |                | 501 136 502 148 |
| 324                 | E30 | 85    | → | 90    | <del>ABS</del> | 501 088 502 068 |
| 324                 | E30 | 85    | → | 90    | ABS            | 501 112 502 072 |
| 324 td/5 Touring    | E30 | 81    | → | 93    | <del>ABS</del> | 501 088 502 072 |
| 324 td/5 Touring    | E30 | 81    | → | 93    | ABS            | 501 112 502 072 |
| 325 e               | E30 | 01/85 | → | 09/85 | <del>ABS</del> | 501 088 502 068 |
| 325 e               | E30 | 01/85 | → | 09/85 | ABS            | 501 112 502 068 |
| 325 e               | E30 | 10/85 | → | 90    | <del>ABS</del> | 501 088 502 072 |
| 325 e               | E30 | 10/85 | → | 90    | ABS            | 501 112 502 072 |
| 325 i               | E30 | 85    | → | 91    | <del>ABS</del> | 501 088 502 072 |
| 325 i               | E30 | 85    | → | 91    | ABS            | 501 112 502 072 |
| 325 ic Cabriolet    | E30 | 85    | → | 92    | <del>ABS</del> | 501 088 502 072 |
| 325 ic Cabriolet    | E30 | 85    | → | 92    | ABS            | 501 112 502 072 |
| 325 i/5 Touring     | E30 | 87    | → | 93    |                | 501 112 502 072 |
| 325 ix/5 Touring    | E30 | 88    | → | 92    |                | - 502 072       |



| MODELL/MODEL/MODELE |     |  | BEMERKUNGEN/REMARKS/<br>REMARQUES |  |  |  |
|---------------------|-----|---|-----------------------------------|--|---|---|
| 325 i               | E36 | 89 → 99   |                                   |  | 501 136   | 502 148   |
| 325 i Cabriolet     | E36 | 93 → 99   |                                   |  | 501 136   | 502 148   |
| 325 i Coupé         | E36 | 92 → 99   |                                   |  | 501 136   | 502 148   |
| 325 td              | E36 | 91 → 99   |                                   |  | 501 136   | 502 148   |
| 325 tds Touring     | E36 | 95 → 99   |                                   |  | 501 136   | 502 148   |
| 325 i               | E46 | 99 → 05   |                                   |  | 501 136   | 502 148   |
| 325 i Touring       | E46 | 00 → 05   |                                   |  | 501 136   | 502 148   |
| 325 Ci Cabriolet    | E46 | 00 → 05   |                                   |  | 501 136   | 502 148   |
| 325 Ci Coupé        | E46 | 00 → 05   |                                   |  | 501 136   | 502 148   |
| 325 ti Compact      | E46 | 01 → 05   |                                   |  | 501 136   | 502 148   |
| 325 xi              | E46 | 99 → 05   |                                   |  | 502 135   | 502 135   |
| 325 xi Touring      | E46 | 99 → 05   |                                   |  | 502 135   | 502 135   |
| 325 i               | E90 | 01/05 → 06  |                                   |  | 501 513   | 502 629   |
| 325 i Touring       | E91 | 01/05 → 06  |                                   |  | 501 513   | 502 629   |
| 325 xi              | E90 | 01/05 → 06  |                                   |  | 501 158   | -   |
| 325 xi Touring      | E91 | 01/05 → 06  |                                   |  | 501 158   | -   |
| 328 i               | E36 | 95 → 99   |                                   |  | 501 136   | 502 148   |
| 328 i Cabriolet     | E36 | 95 → 99   |                                   |  | 501 136   | 502 148   |
| 328 i Coupé         | E36 | 95 → 99   |                                   |  | 501 136   | 502 148   |
| 328 i Touring       | E36 | 95 → 99   |                                   |  | 501 136   | 502 148   |
| 328 i               | E46 | 97 → 01   |                                   |  | 501 136   | 502 148   |
| 328 Ci Coupé        | E46 | 97 → 01   |                                   |  | 501 136   | 502 148   |
| 328 i Touring       | E46 | 97 → 01   |                                   |  | 501 136   | 502 148   |
| 330 i               | E46 | 99 → 04   |                                   |  | 501 136   | 502 135   |
| 330 i Touring       | E46 | 99 → 04   |                                   |  | 501 136   | 502 135   |
| 330 Ci Cabriolet    | E46 | 99 → 04   |                                   |  | 501 136   | 502 135   |
| 330 Ci Coupé        | E46 | 99 → 04   |                                   |  | 501 136   | 502 135   |
| 330 Cd Coupé        | E46 | 03 → 04   |                                   |  | 501 136   | 502 135   |
| 330 d               | E46 | 99 → 04   |                                   |  | 501 136   | 502 135   |
| 330 d               | E46 | 99 → 04   |                                   |  | 501 136   | 502 135   |
| 330 xi              | E46 | 99 → 04   |                                   |  | 502 135   | 502 135   |
| 330 xi Touring      | E46 | 99 → 04   |                                   |  | 502 135   | 502 135   |
| 330 xd              | E46 | 99 → 04   |                                   |  | 502 135   | 502 135   |
| 330 xd Touring      | E46 | 99 → 04   |                                   |  | 502 135   | 502 135   |
| 330 i               | E90 | 01/05 → 06  |                                   |  | 501 513   | 502 629   |
| 330 i Touring       | E91 | 01/05 → 06  |                                   |  | 501 513   | 502 629   |
| 330 d               | E90 | 01/05 → 06  |                                   |  | 501 513   | 502 629   |
| 330 d Touring       | E91 | 01/05 → 06  |                                   |  | 501 513   | 502 629   |
| 330 xi              | E90 | 01/05 → 06  |                                   |  | 501 158   | -   |
| 330 xi Touring      | E91 | 01/05 → 06  |                                   |  | 501 158   | -   |
| 330 xd              | E90 | 01/05 → 06  |                                   |  | 501 158   | -   |
| 330 xd Touring      | E91 | 01/05 → 06  |                                   |  | 501 158   | -   |
| 518                 | E12 | 74 → 81   |                                   |  | 501 184   | 502 178   |
| 518                 | E28 | 80 → 87   |                                   |  | 501 114   | 502 066   |
| 518 i               | E34 | 88 → 03/91  | <del>ABS</del> Mot.M40            |  | 501 170   | 502 066   |
| 518 i               | E34 | 04/91 → 97  | <del>ABS</del> Mot.M40            |  | 501 136   | 502 066   |
| 518 i               | E34 | 90 → 11/91  | <del>ABS</del> Mot.M43            |  | 501 170   | 502 066   |
| 518 i               | E34 | 88 → 11/91  | ABS                               |  | 501 170   | 502 066   |
| 518 i               | E34 | 12/91 → 94  | ABS Mot.M40                       |  | 501 136   | 502 066   |
| 518 i               | E34 | 12/91 → 95  | ABS Mot.M43                       |  | 501 136   | 502 066   |
| 518 i Touring       | E34 | 91 → 97   |                                   |  | 501 136   | 502 070   |
| 520                 | E12 | 72 → 81   |                                   |  | 501 184   | 502 178   |
| 520 i               | E28 | 81 → 04/86  | <del>ABS</del> ⓘ                  |  | 501 114   | 502 070   |
| 520 i               | E28 | 05/86 → 87  | <del>ABS</del> ⓘ                  |  | 501 114   | 502 066   |





## BEMERKUNGEN/REMARKS/ REMARQUES







## MODELL/MODEL/MODELE

| MODELL/MODEL/MODELE |     |            |                             | BEMERKUNGEN/REMARKS/<br>REMARQUES |         |         |
|---------------------|-----|------------|-----------------------------|-----------------------------------|---------|---------|
| 520 i               | E28 | 80 → 87    | <del>ABS</del>              |                                   | 501 114 | 502 066 |
| 520 i               | E28 | 80 → 09/86 | ABS                         |                                   | 501 114 | 502 070 |
| 520 i               | E28 | 10/86 → 87 | ABS                         |                                   | 501 114 | 502 066 |
| 520 i               | E34 | 87 → 90    | Mot.M20                     |                                   | 501 170 | 502 066 |
| 520 i               | E34 | 88 → 03/91 | <del>ABS</del> Mot.M50      |                                   | 501 170 | 502 066 |
| 520 i               | E34 | 04/91 → 95 | <del>ABS</del> Mot.M50      |                                   | 501 136 | 502 066 |
| 520 i               | E34 | 89 → 11/91 | ABS Mot.M50                 |                                   | 501 170 | 502 066 |
| 520 i               | E34 | 12/91 → 95 | ABS Mot.M50                 |                                   | 501 136 | 502 066 |
| 520 i Touring       | E34 | 90 → 96    |                             |                                   | 501 136 | 502 070 |
| 520 i               | E39 | 95 → 04    | ABS - Active Sensor Bearing |                                   | 501 121 | 502 123 |
| 520 i Touring       | E39 | 95 → 04    | ABS - Active Sensor Bearing |                                   | 501 121 | 502 123 |
| 520 d               | E39 | 00 → 04    | ABS - Active Sensor Bearing |                                   | 501 121 | 502 123 |
| 520 d Touring       | E39 | 00 → 04    | ABS - Active Sensor Bearing |                                   | 501 121 | 502 123 |
| 520 i               | E60 | 03 → 06    | ABS - Active Sensor Bearing |                                   | 501 653 | 502 123 |
| 520 i Touring       | E61 | 04 → 06    | ABS - Active Sensor Bearing |                                   | 501 653 | 502 252 |
| 523 i               | E39 | 95 → 00    | ABS - Active Sensor Bearing |                                   | 501 121 | 502 123 |
| 523 i Touring       | E39 | 95 → 00    | ABS - Active Sensor Bearing |                                   | 501 121 | 502 123 |
| 524 d               | E28 | 86 → 87    |                             |                                   | 501 114 | 502 070 |
| 524 td              | E28 | 82 → 88    | <del>ABS</del>              |                                   | 501 114 | 502 066 |
| 524 td              | E28 | 82 → 09/86 | ABS                         |                                   | 501 114 | 502 070 |
| 524 td              | E28 | 10/86 → 87 | ABS                         |                                   | 501 114 | 502 066 |
| 524 td              | E34 | 87 → 03/91 | <del>ABS</del>              |                                   | 501 170 | 502 066 |
| 524 td              | E34 | 04/91 → 97 | <del>ABS</del>              |                                   | 501 136 | 502 066 |
| 524 td              | E34 | 87 → 11/91 | ABS                         |                                   | 501 170 | 502 066 |
| 524 td              | E34 | 12/91 → 95 | ABS                         |                                   | 501 136 | 502 066 |
| 525                 | E12 | 73 → 81    |                             |                                   | 501 184 | 502 178 |
| 525 i               | E28 | 81 → 04/86 | <del>ABS</del>              |                                   | 501 114 | 502 070 |
| 525 i               | E28 | 05/86 → 87 | <del>ABS</del>              |                                   | 501 114 | 502 066 |
| 525 i               | E28 | 81 → 09/86 | ABS                         |                                   | 501 114 | 502 070 |
| 525 i               | E28 | 10/86 → 87 | ABS                         |                                   | 501 114 | 502 066 |
| 525 e               | E28 | 81 → 04/86 |                             |                                   | 501 114 | 502 070 |
| 525 e               | E28 | 05/86 → 87 |                             |                                   | 501 114 | 502 066 |
| 525 i               | E34 | 87 → 90    | Mot.M20                     |                                   | 501 170 | 502 066 |
| 525 i               | E34 | 88 → 03/91 | <del>ABS</del> Mot.M50      |                                   | 501 170 | 502 066 |
| 525 i               | E34 | 04/91 → 97 | <del>ABS</del> Mot.M50      |                                   | 501 136 | 502 066 |
| 525 i               | E34 | 88 → 11/91 | ABS Mot.M50                 |                                   | 501 170 | 502 066 |
| 525 i               | E34 | 12/91 → 95 | ABS Mot.M50                 |                                   | 501 136 | 502 066 |
| 525 ix              | E34 | 91 → 97    |                             |                                   | -       | 502 066 |
| 525 td              | E34 | 92 → 96    |                             |                                   | 501 136 | 502 066 |
| 525 tds             | E34 | 91 → 97    |                             |                                   | 501 136 | 502 066 |
| 525 Touring         | E34 | 90 → 97    |                             |                                   | 501 136 | 502 070 |
| 525 i               | E39 | 96 → 04    | ABS - Active Sensor Bearing |                                   | 501 121 | 502 123 |
| 525 i Touring       | E39 | 00 → 04    | ABS - Active Sensor Bearing |                                   | 501 121 | 502 123 |
| 525 d               | E39 | 00 → 04    | ABS - Active Sensor Bearing |                                   | 501 121 | 502 123 |
| 525 d Touring       | E39 | 00 → 04    | ABS - Active Sensor Bearing |                                   | 501 121 | 502 123 |
| 525 td              | E39 | 96 → 04    | ABS - Active Sensor Bearing |                                   | 501 121 | 502 123 |
| 525 tds             | E39 | 96 → 04    | ABS - Active Sensor Bearing |                                   | 501 121 | 502 123 |
| 525 tds Touring     | E39 | 97 → 04    | ABS - Active Sensor Bearing |                                   | 501 121 | 502 123 |
| 525 i               | E60 | 03 → 06    | ABS - Active Sensor Bearing |                                   | 501 653 | 502 123 |
| 525 i Touring       | E61 | 04 → 06    | ABS - Active Sensor Bearing |                                   | 501 653 | 502 252 |
| 525 d               | E60 | 04 → 06    | ABS - Active Sensor Bearing |                                   | 501 653 | 502 123 |
| 525 d Touring       | E61 | 04 → 06    | ABS - Active Sensor Bearing |                                   | 501 653 | 502 252 |
| 528                 | E12 | 74 → 81    |                             |                                   | 501 184 | 502 178 |
| 528 i               | E28 | 80 → 87    |                             |                                   | 501 114 | 502 070 |











| MODELL/MODEL/MODELE |          |               |  | BEMERKUNGEN/REMARKS/<br>REMARQUES |  |  |
|---------------------|----------|---------------|---|-----------------------------------|---|---|
| 528 i               | E39      | 95 → 01       |   | ABS - Active Sensor Bearing       | 501 121   | 502 123   |
| 528 i Touring       | E39      | 95 → 01       |   | ABS - Active Sensor Bearing       | 501 121   | 502 123   |
| 530 i               | E34      | 87 → 90       |   | Mot.M30                           | 501 170   | 502 070   |
| 530 i               | E34      | 92 → 95       |   | Mot.M60                           | 501 136   | 502 070   |
| 530 i Touring       | E34      | 92 → 97       |   |                                   | 501 136   | 502 070   |
| 530 i               | E39      | 00 → 04       |   | ABS - Active Sensor Bearing       | 501 121   | 502 123   |
| 530 i Touring       | E39      | 00 → 04       |   | ABS - Active Sensor Bearing       | 501 121   | 502 123   |
| 530 d               | E39      | 97 → 04       |   | ABS - Active Sensor Bearing       | 501 121   | 502 123   |
| 530 d Touring       | E39      | 98 → 04       |   | ABS - Active Sensor Bearing       | 501 121   | 502 123   |
| 530 i               | E60      | 03 → 06       |   | ABS - Active Sensor Bearing       | 501 653   | 502 123   |
| 530 i Touring       | E61      | 04 → 06       |   | ABS - Active Sensor Bearing       | 501 653   | 502 252   |
| 530 d               | E60      | 03 → 06       |   | ABS - Active Sensor Bearing       | 501 653   | 502 123   |
| 530 d Touring       | E61      | 04 → 06       |   | ABS - Active Sensor Bearing       | 501 653   | 502 252   |
| 535 Mi              | E12      | 80 → 81       |   |                                   | 501 092   | 502 178   |
| 535                 | E28      | 84 → 88       |   |                                   | 501 114   | 502 070   |
| 535 i               | E34      | 87 → 11/91    |   | ABS                               | 501 170   | 502 070   |
| 535 i               | E34      | 12/91 → 93    |   | ABS                               | 501 136   | 502 070   |
| 535 i               | E39      | 95 → 04       |   | ABS - Active Sensor Bearing       | 501 121   | 502 123   |
| 535 d               | E60      | 04 → 06       |   | ABS - Active Sensor Bearing       | 501 653   | 502 123   |
| 535 d Touring       | E61      | 04 → 06       |   | ABS - Active Sensor Bearing       | 501 653   | 502 252   |
| 540 i               | E34      | 92 → 96       |   | ABS                               | 501 136   | 502 070   |
| 540 i Touring       | E34      | 93 → 96       |   |                                   | 501 136   | 502 070   |
| 540 i               | E39      | 96 → 04       |   | ABS - Active Sensor Bearing       | 501 121   | 502 123   |
| 540 i Touring       | E39      | 97 → 04       |   | ABS - Active Sensor Bearing       | 501 121   | 502 123   |
| 545 i               | E60      | 03 → 06       |   | ABS - Active Sensor Bearing       | 501 653   | 502 123   |
| 545 i Touring       | E61      | 04 → 06       |   | ABS - Active Sensor Bearing       | 501 653   | 502 252   |
| 628 CSi Coupé       | E24      | 79 → 05/82    |   |                                   | 501 092   | 502 178   |
| 628 CSi Coupé       | E24      | 06/82 → 87    |   |                                   | 501 114   | 502 070   |
| 630 CS Coupé        | E24      | 75 → 06/78    |   |                                   | 501 184   | 502 178   |
| 630 CS Coupé        | E24      | 07/78 → 79    |   |                                   | 501 092   | 502 178   |
| 633 CSi Coupé       | E24      | 75 → 06/78    |   |                                   | 501 184   | 502 178   |
| 633 CSi Coupé       | E24      | 07/78 → 81    |   |                                   | 501 092   | 502 178   |
| 635 CSi Coupé       | E24      | 06/78 → 05/82 |   |                                   | 501 092   | 502 178   |
| 635 CSi Coupé       | E24      | 06/82 → 89    |   |                                   | 501 114   | 502 070   |
| 635 MCSi Coupé      | E24      | 83 → 89       |   |                                   | 501 114   | 502 070   |
| 645 Ci Coupé        | E63      | 04 → 06       |   | ABS - Active Sensor Bearing       | 501 653   | 502 252   |
| 645 Ci Cabriolet    | E64      | 04 → 06       |   | ABS - Active Sensor Bearing       | 501 653   | 502 252   |
| 725 tds             | E38      | 95 → 01       |   | ABS - Active Sensor Bearing       | 501 133   | 502 135   |
| 728                 | E23      | 77 → 09/81    |   |                                   | 501 092   | 502 178   |
| 728                 | E23      | 10/81 → 86    |   |                                   | 501 092   | 502 070   |
| 728 i, iL           | E38      | 95 → 01       |   | ABS - Active Sensor Bearing       | 501 133   | 502 135   |
| 730                 | E23      | 76 → 79       |   |                                   | 501 092   | 502 178   |
| 730 i               | E32      | 86 → 11/91    |   | <del>EDC</del> Mot.M30            | 501 170   | 502 070   |
| 730 i               | E32      | 12/91 → 94    |   | <del>EDC</del> Mot.M30            | 501 136   | 502 070   |
| 730 i               | E32      | 86 → 02/92    |   | EDC Mot.M30                       | 501 170   | 502 070   |
| 730 i               | E32      | 03/92 → 94    |   | EDC Mot.M30                       | 501 136   | 502 070   |
| 730 i               | E32      | 91 → 94       |   | Mot.M60                           | 501 136   | 502 070   |
| 730 i, iL           | E38      | 93 → 01       |   | ABS - Active Sensor Bearing       | 501 133   | 502 135   |
| 730 d               | E38      | 98 → 01       |   | ABS - Active Sensor Bearing       | 501 133   | 502 135   |
| 730 i, Li           | E65, E66 | 03 → 06       |   | ABS - Active Sensor Bearing       | 501 147   | 502 252   |
| 730 d               | E65, E66 | 01 → 06       |   | ABS - Active Sensor Bearing       | 501 147   | 502 252   |
| 732 i               | E23      | 79 → 09/81    |   |                                   | 501 092   | 502 178   |
| 732 i               | E23      | 10/81 → 86    |   |                                   | 501 092   | 502 070   |
| 733 i               | E23      | 76 → 09/81    |   |                                   | 501 092   | 502 178   |

| MODELL/MODEL/MODELE |          | BEMERKUNGEN/REMARKS/<br>REMARQUES |                             |  |  |
|---------------------|----------|-----------------------------------|-----------------------------|---|---|
| 733 i               | E23      | 10/81 → 82                        |                             | 501 092   | 502 070   |
| 735                 | E23      | 79 → 09/81                        |                             | 501 092   | 502 178   |
| 735                 | E23      | 10/81 → 86                        |                             | 501 092   | 502 070   |
| 735 i               | E32      | 85 → 11/91                        | EDC                         | 501 170   | 502 070   |
| 735 i               | E32      | 12/91 → 92                        | EDC                         | 501 136   | 502 070   |
| 735 i               | E32      | 85 → 02/92                        | EDC                         | 501 170   | 502 070   |
| 735 i               | E32      | 03/92 → 12/92                     | EDC                         | 501 136   | 502 070   |
| 735 iL              | E32      | 87 → 11/91                        | EDC                         | 501 170   | 502 070   |
| 735 iL              | E32      | 12/91 → 92                        | EDC                         | 501 136   | 502 070   |
| 735 iL              | E32      | 87 → 02/92                        | EDC                         | 501 170   | 502 070   |
| 735 iL              | E32      | 03/92 → 12/92                     | EDC                         | 501 136   | 502 070   |
| 735 i, iL           | E38      | 94 → 01                           | ABS - Active Sensor Bearing | 501 133   | 502 135   |
| 735 i, Li           | E65, E66 | 01 → 06                           | ABS - Active Sensor Bearing | 501 147   | 502 252   |
| 740                 | E32      | 01/91 → 11/91                     |                             | -   | 502 070   |
| 740                 | E32      | 12/91 → 94                        |                             | 501 136   | 502 070   |
| 740 i, iL           | E38      | 95 → 01                           | ABS - Active Sensor Bearing | 501 133   | 502 135   |
| 740 d               | E38      | 99 → 01                           | ABS - Active Sensor Bearing | 501 133   | 502 135   |
| 740 d               | E65, E66 | 01 → 06                           | ABS - Active Sensor Bearing | 501 147   | 502 252   |
| 745 i               | E23      | 79 → 09/81                        |                             | 501 092   | 502 178   |
| 745 i               | E23      | 10/81 → 86                        |                             | 501 092   | 502 070   |
| 745 i, Li           | E65, E66 | 01 → 06                           | ABS - Active Sensor Bearing | 501 147   | 502 252   |
| 750 i               | E32      | 87 → 11/91                        | EDC                         | 501 170   | 502 070   |
| 750 i               | E32      | 12/91 → 94                        | EDC                         | 501 136   | 502 070   |
| 750 i               | E32      | 87 → 02/92                        | EDC                         | 501 170   | 502 070   |
| 750 i               | E32      | 03/92 → 94                        | EDC                         | 501 136   | 502 070   |
| 750 iL              | E32      | 86 → 11/91                        | EDC                         | 501 170   | 502 070   |
| 750 iL              | E32      | 12/91 → 94                        | EDC                         | 501 136   | 502 070   |
| 750 iL              | E32      | 86 → 02/92                        | EDC                         | 501 170   | 502 070   |
| 750 iL              | E32      | 03/92 → 94                        | EDC                         | 501 136   | 502 070   |
| 750 i, iL           | E38      | 94 → 01                           | ABS - Active Sensor Bearing | 501 133   | 502 135   |
| 760 i, Li           | E65, E66 | 03 → 06                           | ABS - Active Sensor Bearing | 501 147   | 502 252   |
| 840 Coupé           | E31      | 92 → 99                           |                             | 501 136   | 502 135   |
| 850 i Coupé         | E31      | 89 → 03/92                        |                             | 501 170   | 502 135   |
| 850 i Coupé         | E31      | 04/92 → 94                        |                             | 501 136   | 502 135   |
| 850 Ci Coupé        | E31      | 89 → 03/92                        | Mot.M70                     | 501 170   | 502 135   |
| 850 Ci Coupé        | E31      | 04/92 → 94                        | Mot.M70                     | 501 136   | 502 135   |
| 850 Ci Coupé        | E31      | 94 → 99                           | Mot.M73                     | 501 136   | 502 135   |
| 850 CSi Coupé       | E31      | 92 → 96                           |                             | 501 170   | 502 135   |
| M 3                 | E30      | 85 → 92                           |                             | 501 049   | 502 072   |
| M 3                 | E36      | 92 → 99                           |                             | 501 136   | 502 135   |
| M 5                 | E28      | 84 → 87                           |                             | 501 114   | 502 070   |
| M 5                 | E34      | 88 → 95                           |                             | -   | 502 070   |
| M 5                 | E39      | 98 → 02                           |                             | 501 121   | 502 123   |
| X 3                 |          | 04 → 05                           |                             | 501 158   | 502 135   |
| X 5                 |          | 00 → 09/03                        |                             | 501 158   | 502 252   |
| X 5                 |          | 10/03 → 05                        |                             | 501 158   | -   |
| Z 1                 |          | 88 → 09/90                        |                             | 501 112   | 502 148   |
| Z 1                 |          | 10/90 → 91                        |                             | 501 112   | 502 109   |
| Z 3 1.8             | E36      | 94 → 98                           |                             | 501 136   | 502 125   |
| Z 3 1.9             | E36      | 94 → 03/99                        | Mot.M43                     | 501 136   | 502 125   |
| Z 3 1.9             | E36      | 04/99 → 02                        | Mot.M43                     | 501 136   | 502 109   |
| Z 3 1.9             | E36      | 94 → 99                           | Mot.M44                     | 501 136   | 502 125   |
| Z 3 2.0             | E36      | 96 → 02                           |                             | 501 136   | 502 109   |
| Z 3 2.2             | E36      | 96 → 02                           |                             | 501 136   | 502 109   |

| MODELL/MODEL/MODELE |     |  | BEMERKUNGEN/REMARKS/<br>REMARQUES |  |  |  |
|---------------------|-----|---|-----------------------------------|--|---|---|
| Z 3 2.8             | E36 | 96 → 02   |                                   |  | 501 136   | 502 109   |
| Z 3 3.0             | E36 | 96 → 02   |                                   |  | 501 136   | 502 109   |
| Z 3 3.2             | E36 | 96 → 02   |                                   |  | 501 136   | 502 135   |
| Z 4 2.2i            |     | 03 → 06   |                                   |  | 501 136   | 502 148   |
| Z 4 3.0i            |     | 03 → 06   |                                   |  | 501 136   | 502 148   |
| Z 4 2.5i            |     | 03 → 06   |                                   |  | 501 136   | 502 148   |
| Z 8                 |     | 00 → 06   |                                   |  | 501 121   | 502 135   |







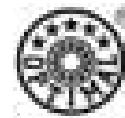



















































| MODELL/MODEL/MODELE            |          |               | BEMERKUNGEN/REMARKS/<br>REMARQUES |         |         |
|--------------------------------|----------|---------------|-----------------------------------|---------|---------|
| Jeep Cherokee 2.1 TD           | (XJ)     | 91 → 08/99    |                                   | 991 946 | -       |
| Jeep Cherokee 2.1 TD           | (XJ)     | 09/99 → 05    |                                   | 991 861 | -       |
| Jeep Cherokee 2.5i             | (XJ)     | 91 → 08/99    |                                   | 991 946 | -       |
| Jeep Cherokee 2.5i             | (XJ)     | 09/99 → 05    |                                   | 991 861 | -       |
| Jeep Cherokee 2.5 TD           | (XJ)     | 91 → 08/99    |                                   | 991 946 | -       |
| Jeep Cherokee 2.5 TD           | (XJ)     | 09/99 → 05    |                                   | 991 861 | -       |
| Jeep Cherokee 4.0i             | (XJ)     | 91 → 08/99    |                                   | 991 946 | -       |
| Jeep Cherokee 4.0i             | (XJ)     | 09/99 → 05    |                                   | 991 861 | -       |
| Jeep Grand Cherokee 4.0i       | (Z, ZJ)  | 91 → 08/99    |                                   | 991 946 | -       |
| Jeep Grand Cherokee 5.2i       | (Z, ZJ)  | 91 → 08/99    |                                   | 991 946 | -       |
| Jeep Grand Cherokee II 2.7 CRD | (WJ, WG) | 01 → 05       |                                   | 991 863 | -       |
| Jeep Grand Cherokee II 3.1 TD  | (WJ, WG) | 04/99 → 05    |                                   | 991 863 | -       |
| Jeep Grand Cherokee II 4.0     | (WJ, WG) | 04/99 → 05    |                                   | 991 863 | -       |
| Jeep Grand Cherokee II 4.7 V8  | (WJ, WG) | 04/99 → 05    |                                   | 991 863 | -       |
| Jeep Wrangler                  |          | 91 → 08/96    |                                   | 991 946 | -       |
| Jeep Wrangler II               | (TJ)     | 09/96 → 05    |                                   | 991 861 | -       |
| Neon II                        |          | 99 → 02       | ABS                               | -       | 992 663 |
| Neon II                        |          | 99 → 02       | ABS                               | -       | 992 689 |
| PT Cruiser 1.6, 2.0            |          | 00 → 02/02    | ABS                               | 991 788 | 992 663 |
| PT Cruiser 1.6, 2.0            |          | 00 → 02/02    | ABS                               | 991 788 | 992 754 |
| PT Cruiser 1.6, 2.0            |          | 03/02 → 05    | ABS                               | 991 749 | 992 663 |
| PT Cruiser 1.6, 2.0            |          | 03/02 → 05    | ABS                               | 991 749 | 992 689 |
| PT Cruiser 2.2 CRD             |          | 03/02 → 05    | ABS                               | 991 749 | 992 663 |
| PT Cruiser 2.2 CRD             |          | 03/02 → 05    | ABS                               | 991 749 | 992 689 |
| PT Cruiser 2.4                 |          | 00 → 02/02    | ABS                               | 991 788 | 992 663 |
| PT Cruiser 2.4                 |          | 00 → 02/02    | ABS                               | 991 788 | 992 754 |
| PT Cruiser 2.4                 |          | 03/02 → 05    | ABS                               | 991 749 | 992 663 |
| PT Cruiser 2.4                 |          | 03/02 → 05    | ABS                               | 991 749 | 992 689 |
| Voyager I                      | (ES)     | 90 → 01/95    | 14"                               | 991 998 | 992 943 |
| Voyager I                      | (ES)     | 90 → 01/95    | 15"                               | 991 898 | 992 943 |
| Voyager II                     | (GS)     | 01/95 → 03/01 | 14"                               | 991 998 | 992 922 |
| Voyager II                     | (GS)     | 01/95 → 03/01 | 15"                               | 991 898 | 992 922 |
| Voyager III                    | (RG)     | 02/00 → 04    |                                   | -       | 992 922 |



| MODELL/MODEL/MODELE    |         |  | BEMERKUNGEN/REMARKS/<br>REMARQUES  |  |  |
|------------------------|---------|---|--|---|---|
| 2 CV 6                 |         | 70 → 91   |  | 601 440   | 602 418   |
| AX                     |         | 07/86 → 12/98   |  | 04-P189   | -   |
| AX 10                  |         | 87 → 98   |  | 600 334   | 602 322   |
| AX 11                  |         | 87 → 98   |  | 600 334   | 602 322   |
| AX 13 Sport            |         | 87 → 91   |  | 600 334   | 602 322   |
| AX 14                  |         | 87 → 04/91  | Ch.→5277   | 600 334   | 602 322   |
| AX 14                  |         | 04/91 → 96  | Ch.5278→   | 601 306   | 602 322   |
| AX 14 Diesel           |         | 89 → 04/91  | Ch.→5277   | 600 334   | 602 322   |
| AX 14 Diesel           |         | 04/91 → 95  | Ch.5278→   | 601 306   | 602 322   |
| AX 14 4x4              |         | 91 → 97   |  | 601 306   | 600 334   |
| AX 14 GT               |         | 89 → 04/91  | Ch.→5277   | 600 334   | 602 322   |
| AX 14 GT               |         | 04/91 → 97  | Ch.5278→   | 601 306   | 602 322   |
| AX 14 GTI              |         | 89 → 04/91  | Ch.→5277   | 600 334   | 602 320   |
| AX 14 GTI              |         | 04/91 → 97  | Ch.5278→   | 601 306   | 602 320   |
| AX 15 Diesel           |         | 95 → 97   |  | 601 306   | 602 322   |
| Axel/Oltcit            |         | 84 → 90   |  | -   | 602 512   |
| Berlingo               |         | 96 → 04   | <del>ABS</del>   | 600 308   | 602 337   |
| Berlingo               |         | 96 → 04   | ABS  29 | 600 308   | 602 345   |
| Berlingo               |         | 04 → 05   | ABS - Active Sensor Bearing  | 600 308   | -   |
| Berlingo 4x4           |         | 97 → 04   |  | 600 308   | -   |
| Berlingo Electric SA18 |         | 96 → 04   |  | 600 308   | 602 337   |
| BX                     |         | 83 → 08/84  | <del>ABS</del>   | 601 336   | 602 340   |
| BX                     |         | 83 → 08/84  | ABS  | 601 336   | 602 388   |
| BX                     |         | 09/84 → 94  | <del>ABS</del>   | 600 308   | 602 340   |
| BX                     |         | 09/84 → 94  | ABS  | 600 308   | 602 388   |
| BX 4x4                 |         | 88 → 93   |  | 600 308   | 600 308   |
| C 1                    |         | 06/05 → 12/06   |  | 601 834   | 602 835   |
| C 2                    | Front   | 02 → 06   | <del>ABS</del>   | 601 916   | -   |
| C 2                    | Front   | 02 → 06   | ABS - Active Sensor Bearing  | 601 253   | -   |
| C 2                    | Rear    | 02 → 06   |       | -   | 602 669   |
| C 2                    | Rear    | 02 → 06   |       | -   | 602 251   |
| C 3                    | Front   | 02 → 06   | <del>ABS</del>   | 601 916   | -   |
| C 3                    | Front   | 02 → 06   | ABS - Active Sensor Bearing  | 601 253   | -   |
| C 3                    | Rear    | 02 → 06   |       | -   | 602 669   |
| C 3                    | Rear    | 02 → 06   |       | -   | 602 251   |
| C 4                    |         | 03 → 08/06  | ABS - Active Sensor Bearing  | 601 953   | 602 893   |
| C 4                    |         | 09/06 → 12/06   | ABS - Active Sensor Bearing  | 601 953   | -   |
| C 4 Picasso            |         | 09/06 → 12/06   | ABS - Active Sensor Bearing  | 601 953   | -   |
| C 5                    |         | 01 → 06   | ABS - Active Sensor Bearing  | 601 953   | 602 955   |
| C 5 Break              |         | 01 → 06   | ABS - Active Sensor Bearing  | 601 953   | 602 955   |
| C 6 2.2 Hdi            |         | 09/05 → 06  | ABS - Active Sensor Bearing  | 601 675   | 602 681   |
| C 6 2.7 Hdi            |         | 06/06 → 12/06   | ABS - Active Sensor Bearing  | 601 675   | 602 681   |
| C 6 3.0 V6 24V         |         | 09/05 → 06  | ABS - Active Sensor Bearing  | 601 675   | 602 681   |
| C 8 2.0                |         | 02 → 06   | ABS - Active Sensor Bearing  | 681 261   | 682 263   |
| C 8 2.0 Hdi            |         | 02 → 06   | ABS - Active Sensor Bearing  | 681 261   | 682 263   |
| C 8 2.2                |         | 02 → 06   | ABS - Active Sensor Bearing  | 681 261   | 682 263   |
| C 8 2.2 Hdi            |         | 02 → 06   | ABS - Active Sensor Bearing  | 681 261   | 682 263   |
| C 8 3.0 V6 24V         |         | 02 → 06   | ABS - Active Sensor Bearing  | 681 259   | 682 263   |
| C 15 Diesel            |         | 07/86 → 12/97   |  | 04-P187   | -   |
| C 15 1.0               |         | 85 → 05/88  | Ch.→4195   | 601 396   | -   |
| C 15 1.0               |         | 05/88 → 98  | Ch.4196→   | 601 306   | 602 340   |
| C 15 1124ccm           |         | 07/88 → 12/96   |  | 04-P187   | -   |
| C 15 1360ccm           |         | 05/91 → 12/96   |  | 04-P187   | -   |
| C 15 1.1               | 1118ccm | 85 → 98   |  | 601 306   | 602 340   |







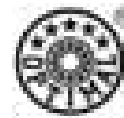

| MODELL/MODEL/MODELE        |         | BEMERKUNGEN/REMARKS/<br>REMARQUES |                       |         |         |
|----------------------------|---------|-----------------------------------|-----------------------|---------|---------|
| C 15 1.1                   | 1124ccm | 85 → 05/88                        | Ch.→4195              | 601 396 | -       |
| C 15 1.1                   | 1124ccm | 05/88 → 98                        | Ch.4196→              | 601 306 | 602 340 |
| C 15 1.3                   |         | 85 → 88                           |                       | 601 306 | 602 340 |
| C 15 1.4                   |         | 85 → 05/88                        | Ch.→4195              | 601 396 | -       |
| C 15 1.4                   |         | 05/88 → 98                        | Ch.4196→              | 601 306 | 602 340 |
| C 15 1.8 Diesel            |         | 85 → 00                           |                       | 601 306 | 602 340 |
| C 15 1.9 Diesel            |         | 00 → 02                           |                       | 601 306 | 602 340 |
| CX                         |         | 03/82 → 92                        |                       | 601 434 | 602 358 |
| CX                         |         | 03/82 → 92                        |                       | 601 434 | 602 392 |
| Dyane 6                    |         | 80 → 83                           |                       | 601 440 | 602 418 |
| Evasion                    |         | 94 → 02                           |                       | 681 303 | 682 305 |
| Evasion                    |         | 06/94 → 02                        |                       | 04-P193 | -       |
| GS                         |         | 70 → 80                           |                       | -       | 602 416 |
| GSA                        |         | 79 → 03/81                        |                       | -       | 602 416 |
| GSA                        |         | 04/81 → 86                        |                       | 601 502 | 602 416 |
| Jumpy                      |         | 95 → 06                           |                       | 681 303 | 682 305 |
| LNA                        |         | 07/80 → 86                        |                       | 601 396 | 602 414 |
| Méhari 4x2                 |         | 68 → 87                           |                       | 601 440 | 602 418 |
| Méhari 4x4                 |         | 79 → 83                           |                       | 601 440 | 602 865 |
| Saxo 1.0i                  |         | 96 → 01/99                        | Airbag                | 600 334 | 602 322 |
| Saxo                       |         | 05/96 → -                         | Ch.-->8093            | 04-P187 | -       |
| Saxo 1.0i                  |         | 96 → 01/99                        | Airbag                | 600 334 | 602 320 |
| Saxo                       |         | 05/96 → -                         | Ch.8094-->            | 04-P195 | -       |
| Saxo 1.0i                  |         | 02/99 → 09/99                     | Airbag                | 600 334 | 602 926 |
| Saxo 1.0i                  |         | 02/99 → 09/99                     | Airbag                | 600 334 | 602 858 |
| Saxo 1.0i                  |         | 10/99 → 04                        |                       | 601 916 | 602 858 |
| Saxo 1.1i                  |         | 96 → 01/99                        | ABS                   | 600 334 | 602 322 |
| Saxo 1.1i                  |         | 02/99 → 09/99                     | ABS                   | 600 334 | 602 926 |
| Saxo 1.1i                  |         | 96 → 01/99                        | ABS                   | 601 306 | 602 320 |
| Saxo 1.1i                  |         | 02/99 → 09/99                     | ABS                   | 601 916 | 602 858 |
| Saxo 1.1i                  |         | 10/99 → 04                        |                       | 601 916 | 602 858 |
| Saxo 1.0i, 1.1i Entreprise |         | 96 → 01/99                        | Reinforced suspension | 601 306 | 602 320 |
| Saxo 1.0i, 1.1i Entreprise |         | 02/99 → 04                        | Reinforced suspension | 601 916 | 602 858 |
| Saxo 1.0i, 1.1i Entreprise |         | 96 → 07/97                        | Reinforced suspension | 600 334 | 602 320 |
| Saxo 1.0i, 1.1i Entreprise |         | 08/97 → 01/99                     | Reinforced suspension | 601 306 | 602 320 |
| Saxo 1.0i, 1.1i Entreprise |         | 02/99 → 04                        | Reinforced suspension | 601 916 | 602 858 |
| Saxo 1.4i                  |         | 96 → 01/99                        |                       | 601 306 | 602 320 |
| Saxo 1.4i                  |         | 02/99 → 04                        |                       | 601 916 | 602 858 |
| Saxo 1.5 Diesel            |         | 96 → 01/99                        |                       | 601 306 | 602 320 |
| Saxo 1.5 Diesel            |         | 02/99 → 04                        |                       | 601 916 | 602 858 |
| Saxo 1.6i                  |         | 96 → 01/99                        | {Rear  }              | 601 306 | 602 320 |
| Saxo 1.6i                  |         | 02/99 → 04                        | {Rear  }              | 601 916 | 602 858 |
| Saxo 1.6i                  |         | 96 → 01/99                        | {Rear  } ABS          | 601 306 | 602 347 |
| Saxo 1.6i                  |         | 02/99 → 04                        | {Rear  } ABS          | 601 916 | 602 347 |
| Saxo 1.6i                  |         | 96 → 01/99                        | {Rear  } ABS          | 601 306 | 602 349 |
| Saxo 1.6i                  |         | 02/99 → 04                        | {Rear  } ABS          | 601 916 | 602 349 |
| Saxo SA13 Electrique       |         | 97 → 01/99                        |                       | 601 306 | 602 320 |
| Saxo SA13 Electrique       |         | 02/99 → 04                        |                       | 601 916 | 602 858 |
| Visa                       |         | 78 → 91                           |                       | 04-P187 | -       |
| Visa                       |         | 07/80 → 84                        |                       | 601 396 | 602 414 |
| Visa 0.6                   |         | 85 → 91                           |                       | 601 396 | 602 414 |
| Visa 1.0                   |         | 85 → 89                           |                       | 601 396 | 602 414 |
| Visa 1.1                   |         | 85 → 91                           |                       | 601 396 | 602 414 |
| Visa 1.4                   |         | 85 → 91                           |                       | 601 396 | 602 414 |









| MODELL/MODEL/MODELE                  |  | BEMERKUNGEN/REMARKS/<br>REMARQUES  |  |  |
|--------------------------------------|---|--|---|---|
| Visa 1.6 GTI                         | 85 → 89   |  | 601 306   | 602 320   |
| Visa 1.7 Diesel                      | 85 → 89   |  | 601 306   | 602 320   |
| Xantia                               | 93 → 06/95  | Ch.→6778 <del>ABS</del>  | 600 308   | 602 340   |
| Xantia                               | 93 → 06/95  | Ch.→6778 ABS   | 600 308   | 602 341   |
| Xantia                               | 06/95 → 05  | Ch.6779→ <del>ABS</del>  | 600 308   | 602 337   |
| Xantia                               | 06/95 → 05  | Ch.6779→ ABS   | 600 308   | 602 339   |
| XM                                   | 89 → 04/97  | Ch.→7477   | 601 348   | 602 356   |
| XM                                   | 04/97 → 00  | Ch.7478→   | 601 323   | 602 356   |
| Xsara Break 1.4, 1.6, Coupe 1.4, 1.6 | 97 → -  |  | 04-P195   | -   |
| Xsara 1.4, 1.5 D, 1.6                | Front 97 → 01/99  | Mot.TU/TUD <del>ABS</del> Ch.→8098   | 601 306   | -   |
| Xsara 1.4, 1.5 D, 1.6                | Front 01/99 → 09/00   | Mot.TU/TUD <del>ABS</del> Ch.8099→   | 601 916   | -   |
| Xsara 1.4, 1.5 D, 1.6                | Front 10/00 → 05  | Mot.TU/TUD <del>ABS</del>  | 600 308   | -   |
| Xsara 1.4, 1.5 D, 1.6                | Front 97 → 05   | Mot.TU/TUD ABS   | 600 308   | -   |
| Xsara 1.8i, 1.8 D/TD, 1.9 D/TD       | Front 97 → 05   | Mot.XU/XUD   | 600 308   | -   |
| Xsara 2.0 16V                        | Front 97 → 05   | Mot.XU   | 600 308   | -   |
| Xsara 2.0 HdI                        | Front 98 → 05   | Mot.DW   | 600 308   | -   |
| Xsara 1.4, 1.5 D, 1.6                | Rear 97 → 09/98   |  Mot.TU/TUD   | -   | 602 320   |
| Xsara 1.4, 1.5 D, 1.6                | Rear 10/98 → 05   |  Mot.TU/TUD   | -   | 602 858   |
| Xsara 1.8i, 1.8 D/TD, 1.9 D/TD       | Rear 97 → 09/98   |   Mot.XU/XUD                 | -   | 602 320   |
| Xsara 1.8i, 1.8 D/TD, 1.9 D/TD       | Rear 97 → 09/98   |   Mot.XU/XUD                 | -   | 602 314   |
| Xsara 1.8i, 1.8 D/TD, 1.9 D/TD       | Rear 10/98 → 05   |   Mot.XU/XUD                 | -   | 602 858   |
| Xsara 1.8i, 1.8 D/TD, 1.9 D/TD       | Rear 10/98 → 05   |   Mot.XU/XUD                 | -   | 602 386   |
| Xsara 2.0i 16V                       | Rear 97 → 09/98   |   Mot.XU                   | -   | 602 320   |
| Xsara 2.0i 16V                       | Rear 97 → 09/98   |   Mot.XU                 | -   | 602 314   |
| Xsara 2.0i 16V                       | Rear 10/98 → 05   |   Mot.XU                 | -   | 602 858   |
| Xsara 2.0i 16V                       | Rear 10/98 → 05   |   Mot.XU                 | -   | 602 386   |
| Xsara 2.0 HdI                        | Rear 98 → 09/98   |   Mot.DW                 | -   | 602 320   |
| Xsara 2.0 HdI                        | Rear 10/98 → 05   |   Mot.DW                 | -   | 602 858   |
| Xsara 2.0 HdI                        | Rear 98 → 05  |   Mot.DW                 | -   | 602 386   |
| Xsara                                | Rear 97 → 09/98   |  Reinforced suspension  | -   | 602 320   |
| Xsara                                | Rear 10/98 → 05   |  Reinforced suspension  | -   | 602 858   |
| Xsara Break                          | Rear 97 → 09/98   |                          | -   | 602 361   |
| Xsara Break                          | Rear 97 → 09/98   |                          | -   | 602 314   |
| Xsara Break                          | Rear 10/98 → 05   |                          | -   | 602 645   |
| Xsara Break                          | Rear 10/98 → 05   |                          | -   | 602 386   |
| Xsara Break                          | Rear 97 → 09/98   |  Reinforced suspension  | -   | 602 361   |
| Xsara Break                          | Rear 10/98 → 05   |  Reinforced suspension  | -   | 602 645   |
| Xsara Picasso                        | 99 → 05   | <del>ABS</del>   | 600 308   | 602 337   |
| Xsara Picasso                        | 99 → 04   | ABS  29   | 600 308   | 602 345   |
| Xsara Picasso                        | 99 → 04   | ABS  48   | 600 308   | 602 339   |
| Xsara Picasso                        | 04 → 05   | ABS - Active Sensor Bearing  | 600 308   | -   |
| ZX 1.4                               | 03/91 → 97  |  | 04-P187   | -   |
| ZX 1.6, 1.7, 1.8, 1.9                | 03/91 → 97  | ABS  | 04-P191   | -   |
| ZX 1.1, 1.4                          | 91 → 98   |  <del>ABS</del> {Rear  } | 601 306   | 602 320   |
| ZX 1.1, 1.4                          | 91 → 98   |  ABS {Rear  }            | 600 308   | 602 314   |
| ZX 1.1, 1.4                          | 91 → 98   |  <del>ABS</del>   | 601 306   | 602 361   |
| ZX 1.1, 1.4                          | 91 → 98   |  ABS  | 600 308   | 602 361   |
| ZX 1.4 Diesel, 1.5 Diesel            | 91 → 98   |                          | 601 306   | 602 320   |
| ZX 1.4 Diesel, 1.5 Diesel            | 91 → 98   |                          | 601 306   | 602 314   |
| ZX 1.4 Diesel, 1.5 Diesel            | 91 → 98   |   | 601 306   | 602 361   |
| ZX 1.6                               | 91 → 98   |                          | 600 308   | 602 320   |
| ZX 1.6                               | 91 → 98   |                          | 600 308   | 602 314   |
| ZX 1.6                               | 91 → 98   |   | 600 308   | 602 361   |
| ZX 1.7 Diesel                        | 91 → 98   |                          | 600 308   | 602 320   |





















| MODELL/MODEL/MODELE             |               | BEMERKUNGEN/REMARKS/<br>REMARQUES |                  |         |         |
|---------------------------------|---------------|-----------------------------------|------------------|---------|---------|
| ZX 1.7 Diesel                   | 91 → 98       |                                   |                  | 600 308 | 602 314 |
| ZX 1.7 Diesel                   | 91 → 98       |                                   |                  | 600 308 | 602 361 |
| ZX 1.8                          | 91 → 98       |                                   |                  | 600 308 | 602 320 |
| ZX 1.8                          | 91 → 98       |                                   |                  | 600 308 | 602 314 |
| ZX 1.8                          | 91 → 98       |                                   |                  | 600 308 | 602 361 |
| ZX 1.9 Diesel, 1.9 Turbo Diesel | 91 → 98       |                                   |                  | 600 308 | 602 320 |
| ZX 1.9 Diesel, 1.9 Turbo Diesel | 91 → 98       |                                   |                  | 600 308 | 602 314 |
| ZX 1.9 Diesel, 1.9 Turbo Diesel | 91 → 98       |                                   |                  | 600 308 | 602 361 |
| ZX 2.0                          | 91 → 98       |                                   |                  | 600 308 | 602 320 |
| ZX 2.0                          | 91 → 98       |                                   |                  | 600 308 | 602 314 |
| ZX 2.0                          | 91 → 98       |                                   |                  | 600 308 | 602 361 |
| C 25 1000 kg                    | 82 → 86       |                                   | Ch.→289710       | 681 504 | 682 420 |
| C 25 serie I                    | - → 85        |                                   |                  | 04-P207 | -       |
| C 25 1000 kg                    | 82 → 86       |                                   | Ch.→289710       | 681 504 | 682 422 |
| C 25 serie II                   | 85 → 89       |                                   |                  | 04-P183 | -       |
| C 25 1000 kg                    | 86 → 89       |                                   | Ch.289711→604496 | 681 504 | 682 508 |
| C 25 serie III                  | 89 → -        |                                   |                  | 04-P205 | -       |
| C 25 1000 kg                    | 86 → 89       |                                   | Ch.289711→604496 | 681 504 | 682 510 |
| C 25                            | 94 → -        |                                   | 1000 - 1400 kg   | 04-P185 | -       |
| C 25 1000 kg                    | 89 → 94       |                                   | Ch.604497→       | 681 506 | 682 508 |
| C 25 1000 kg                    | 89 → 94       |                                   | Ch.604497→       | 681 506 | 682 510 |
| C 25 1300 kg                    | 82 → 87       |                                   | Ch.→289710       | 681 504 | 682 420 |
| C 25 1300 kg                    | 82 → 87       |                                   | Ch.→289710       | 681 504 | 682 422 |
| C 25 1300 kg                    | 87 → 87       |                                   | Ch.289711→       | 681 504 | 682 508 |
| C 25 1300 kg                    | 87 → 87       |                                   | Ch.289711→       | 681 504 | 682 510 |
| C 25 1400 kg                    | 87 → 89       |                                   | Ch.→604496       | 681 504 | 682 508 |
| C 25 1400 kg                    | 87 → 89       |                                   | Ch.→604496       | 681 504 | 682 510 |
| C 25 1400 kg                    | 89 → 94       |                                   | Ch.604497→       | 681 506 | 682 508 |
| C 25 1400 kg                    | 89 → 94       |                                   | Ch.604497→       | 681 506 | 682 510 |
| C 25 1800 kg                    | 86 → 89       |                                   | Ch.→604496       | 681 504 | 682 492 |
| C 25 1800 kg                    | 86 → 89       |                                   | Ch.→604496       | 681 504 | 682 490 |
| C 25 1800 kg                    | 89 → 94       |                                   | Ch.604497→       | 681 506 | 682 492 |
| C 25 1800 kg                    | 89 → 94       |                                   | Ch.604497→       | 681 506 | 682 490 |
| C 25 4x4                        | 86 → 89       |                                   | Ch.→604496       | 681 504 | 602 430 |
| C 25 4x4                        | 89 → 92       |                                   | Ch.604497→       | 681 506 | 602 430 |
| C 35                            | 73 → 92       |                                   |                  | 681 640 | 682 642 |
| Jumper 1800 kg                  | 89 → -        |                                   |                  | 04-P181 | -       |
| Jumper 1000 kg                  | 94 → 04/02    |                                   | Ch.→16194399     | 681 506 | 682 327 |
| Jumper                          | 94 → -        |                                   | 1000 -1400 kg    | 04-P185 | -       |
| Jumper 1000 kg                  | 04/02 → 04/06 |                                   | Ch.16194400→     | 681 375 | 682 437 |
| Jumper 1000 kg 4x4              | 96 → 04/02    |                                   | Ch.→16194399     | 681 506 | 681 506 |
| Jumper 1000 kg 4x4              | 04/02 → 04/06 |                                   | Ch.16194400→     | 681 375 | -       |
| Jumper 1400 kg                  | 94 → 04/02    |                                   | Ch.→16194399     | 681 506 | 682 327 |
| Jumper 1400 kg                  | 04/02 → 04/06 |                                   | Ch.16194400→     | 681 375 | 682 437 |
| Jumper 1400 kg 4x4              | 96 → 04/02    |                                   | Ch.→16194399     | 681 506 | 681 506 |
| Jumper 1400 kg 4x4              | 04/02 → 04/06 |                                   | Ch.16194400→     | 681 375 | -       |
| Jumper 1800 kg                  | 94 → 04/02    |                                   | Ch.→16194399     | 681 325 | 682 329 |
| Jumper 1800 kg                  | 04/02 → 04/06 |                                   | Ch.16194400→     | 681 471 | 682 437 |
| Jumper 1800 kg 4x4              | 96 → 04/02    |                                   | Ch.→16194399     | 681 325 | 681 506 |
| Jumper 1800 kg 4x4              | 04/02 → 04/06 |                                   | Ch.16194400→     | 681 471 | -       |

| MODELL/MODEL/MODELE |  | BEMERKUNGEN/REMARKS/<br>REMARQUES  |  |  |
|---------------------|---|--|---|---|
| Dacia 1.2, 1.3, 1.4 | 78 → 99   |                   | 701 332   | 702 328   |
| Dacia 1.2, 1.3, 1.4 | 78 → 99   |                   | 701 332   | 702 817   |
| Denem               | 82 → 99   |  | 701 332   | 702 328   |
| Duster              | 84 → 93   |  | 701 302   | -   |
| Logan 1.4           | 04 → 06   | <del>ABS</del>   | 700 310   | 702 312   |
| Logan 1.4           | 04 → 06   | ABS  | 701 837   | 702 312   |
| Logan 1.5 dCi       | 09/05 → 06  | <del>ABS</del>   | 700 310   | 702 312   |
| Logan 1.5 dCi       | 09/05 → 06  | ABS  | 701 837   | 702 312   |
| Logan 1.6           | 04 → 06   | <del>ABS</del>   | 700 310   | 702 312   |
| Logan 1.6           | 04 → 06   | ABS  | 701 837   | 702 312   |
| Nova                | 98 → 02   | {Front  42x82x36} | 600 308   | 602 320   |
| Nova                | 98 → 02   | {Front  35x72x33} | 601 306   | 602 320   |
| Shifter             | 82 → 99   |  | 701 332   | 702 328   |



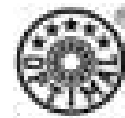

| MODELL/MODEL/MODELE        |  | BEMERKUNGEN/REMARKS/<br>REMARQUES  |  |  |
|----------------------------|---|--|---|---|
| Cielo 1500 MPI             | 94 → 96   | <del>ABS</del>   | 971 391   | 972 389   |
| Cielo 1500 MPI             | 94 → 96   | ABS  | 971 393   | 972 389   |
| Cielo 1800 MPI             | 94 → 96   | <del>ABS</del>   | 971 391   | 972 389   |
| Cielo 1800 MPI             | 94 → 96   | ABS  | 971 393   | 972 389   |
| Damas                      | 90 → 92   |  | 971 567   | -   |
| Espero                     | 92 → 99   | <del>ABS</del>   | 971 393   | 972 389   |
| Espero                     | 92 → 99   | ABS  | 971 393   | 972 397   |
| Evanda 2.0 16V             | 02 → 05   |  | 971 940   | -   |
| Fino Y3S112                | 93 → 94   |  | 971 455   | 972 453   |
| Kalos                      | 02 → 04   |  | 971 391   | -   |
| Korando (Ssangyong) (KJ)   | 99 → 03   |  | 971 290   | -   |
| Labo Y7T51                 | 90 → 92   |  | 971 567   | -   |
| Lanos 1.4i, 1.5i SOHC      | 97 → 05   |  13"  | 971 391   | 972 389   |
| Lanos 1.4i, 1.5i DOHC      | 97 → 05   |  14"  | 971 393   | 972 389   |
| Lanos 1.6i 16V             | 97 → 05   | <del>ABS</del>   | 971 393   | 972 389   |
| Lanos 1.6i 16V             | 97 → 05   | ABS  | 971 393   | 972 397   |
| Leganza                    | 97 → 03   |  15"  | 971 940   | -   |
| Lemans                     | 92 → 93   |  | 971 391   | 972 389   |
| Matiz                      | 98 → 05   |  | 971 917   | 972 918   |
| Mica Y3S112                | 93 → 94   |  | 971 455   | 972 453   |
| Musso 4WD (Ssangyong) (FJ) | 99 → 03   |  | 971 290   | -   |
| Nexia 1.5i 8V              | 95 → 97   |  13"  | 971 391   | 972 389   |
| Nexia 1.5i 16V DOHC        | 95 → 97   |  14" | 971 393   | 972 389   |
| Nexia 1.8i                 | 95 → 97   |  | 971 393   | 972 389   |
| Nubira                     | 97 → 04   |  | 971 393   | 972 389   |
| Racer                      | 95 → 00   |  | 971 391   | 972 389   |
| Rezzo                      | 01 → 03   |  | 971 940   | -   |
| Tacuma                     | 01 → 03   |  | 971 940   | -   |
| Tico                       | 11/93 → 98  |  | 971 455   | 972 453   |
| Lublin II                  | 97 → 03   |     | -   | 682 175   |

| MODELL/MODEL/MODELE     |                |  | BEMERKUNGEN/REMARKS/<br>REMARQUES   |   |  |  |
|-------------------------|----------------|---|---|---|---|---|
| Applause I 1.6i 16V     | (A101)         | 06/89 → 97  |   |   | 901 425   | 901 429   |
| Applause I 1.6i 16V 4WD | (A111)         | 06/89 → 97  |   |   | 901 425   | 901 429   |
| Applause II 1.6i 16V    |                | 07/97 → 02  |   |   | 901 425   | 901 429   |
| Charade 1.0             | (G10, G20)     | 78 → 83   |   |   | 901 461   | 902 459   |
| Charade 1.0             | (G11, G30)     | 83 → 86   |   |   | 901 461   | 902 457   |
| Charade 1.0             | (G21)          | 83 → 86   |   |   | 901 461   | 902 457   |
| Charade 1.0             | (G100/101/112) | 87 → 88   |   |   | 901 429   | 902 457   |
| Charade 1.0             | (G100/101/112) | 89 → 93   |   |   | 901 425   | 902 457   |
| Charade 1.0             | (G200/201/202) | 93 → 96   |   |   | 901 425   | 902 457   |
| Charade 1.3i 16V        | (G102)         | 87 → 88   |   |   | 901 429   | 902 457   |
| Charade 1.3i 16V 4WD    | (G112)         | 87 → 88   |   |   | 901 429   | 901 429   |
| Charade 1.3i 16V        | (G102)         | 89 → 92   | <del>4-Doors</del>  |   | 901 425   | 902 457   |
| Charade 1.3i 16V        | (G102)         | 90 → 92   | 4-Doors   |   | 901 425   | 902 771   |
| Charade 1.3i 16V 4WD    | (G112)         | 89 → 92   |   |   | 901 425   | 901 429   |
| Charade 1.3i 16V        | (G200/201/202) | 93 → 98   |   |   | 901 425   | 902 457   |
| Charade 1.5i 16V        | (G203)         | 93 → 98   | <del>ABS</del>  |   | 901 425   | 902 771   |
| Charade 1.5i 16V        | (G203)         | 93 → 98   | ABS   |   | 901 425   | 902 547   |
| Charade 1.6i 16V GTI    | (G200/201/202) | 93 → 98   |   |   | 901 425   | 902 457   |
| Charmant                | (A35,A45,A60)  | 81 → 86   |   |   | 981 790   | -   |
| Cuore 850               | (L80)          | 08/85 → 90  |   |   | 901 427   | 902 459   |
| Cuore 850               | (L201)         | 03/90 → 94  |   |   | 901 427   | 902 459   |
| Cuore 850               | (L501)         | 10/94 → 98  |   |   | 901 427   | 902 459   |
| Cuore 850 4WD           | (L80)          | 87 → 90   |   |   | 901 427   | 902 459   |
| Cuore 1000              | (L701)         | 98 → 02   |   |   | 901 231   | -   |
| Cuore 1000 12V          | (L251)         | 03 → 04   |   |   | 901 231   | -   |
| Domino 850              | (L80, L81)     | 09/85 → 06/90   |   |   | 901 427   | 902 459   |
| Domino 850              | (L201)         | 10/90 → 94  |   |   | 901 427   | 902 459   |
| Gran Move 1.5i 16V      | (G303, G313)   | 10/96 → 02  | <del>ABS</del>  |   | 901 425   | 902 771   |
| Gran Move 1.5i 16V      | (G303, G313)   | 10/96 → 02  | ABS   |   | 901 425   | 902 547   |
| Gran Move 1.6i          | (G301)         | 98 → 02   | <del>ABS</del>  |   | 901 425   | 902 771   |
| Gran Move 1.6i          | (G301)         | 98 → 02   | ABS   |   | 901 425   | 902 547   |
| Handi 850               | (L80)          | 09/85 → 90  |   |   | 901 427   | 902 459   |
| Mira 850                | (L80)          | 10/85 → 06/90   |   |   | 901 427   | 902 459   |
| Mira 850                | (L201)         | 10/90 → 94  |   |   | 901 427   | 902 459   |
| Move 850                | (L601)         | 97 → 02   |   |   | 901 427   | 902 459   |
| Move 1000               | (L901)         | 98 → 02   |   |   | 901 427   | 902 459   |
| Sirion 1.0i 12V         | (M100)         | 98 → 04   |   |   | 901 231   | 902 999   |
| Sirion 1.3i 16V         | (M101)         | 00 → 04   |   |   | 901 231   | 902 999   |
| Sirion 4WD 1.0i 12V     | (M110)         | 99 → 04   |   |   | 901 231   | -   |
| Sirion 4WD 1.3i 16V     | (M111)         | 00 → 04   |   |   | 901 231   | -   |
| Terios 1.3i 16V         | (J100)         | 01 → 04   |   |   | 901 425   | 902 999   |
| Terios 4WD 1.3i 16V     | (J100)         | 97 → 04   |   |   | 901 425   | -   |
| Feroza 1.6 16V          | (F300)         | 10/88 → 05/97   |  |   | 901 549   | 902 443   |
| Feroza 1.6 16V          | (F310)         | 05/92 → 05/97   |  |   | 901 549   | 902 443   |
| Fourtrak 2.8 Diesel     |                | 84 → 87   |  |   | 901 445   | 902 443   |
| Hijet                   | (S60, S70)     | 81 → 86   |  |   | 901 890   | 902 901   |
| Hijet                   | (S75, S77)     | 81 → 86   |  |   | 901 890   | 902 891   |
| Hijet                   | (S8..)         | 10/86 → 87  |  |   | 901 885   | -   |
| Hijet 850               | (S84)          | 88 → 92   |  |  | 901 890   | 902 891   |
| Hijet 850               | (S84)          | 88 → 92   |  |  | 901 890   | 902 901   |
| Hijet 1000              | (S85)          | 88 → 92   |  |  | 901 890   | 902 891   |
| Hijet 1000              | (S85)          | 88 → 92   |  |  | 901 890   | 902 901   |
| Hijet 1000              | (S85)          | 01/93 → 09/93   |  |   | 901 876   | 902 891   |
| Hijet 1000              | (S85)          | 10/93 → 95  |  |   | 901 876   | 902 908   |









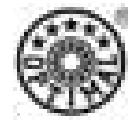









| MODELL/MODEL/MODELE |               |         |       | BEMERKUNGEN/REMARKS/<br>REMARQUES |  |         |         |
|---------------------|---------------|---------|-------|-----------------------------------|--|---------|---------|
| Hijet 1200 Diesel   | (S85)         | 10/95 → | 98    |                                   |  | 901 876 | -       |
| Hijet 1300i 16V     | (S85)         | 05/98 → | 02    |                                   |  | 901 876 | -       |
| Hijet 4x4           | (S86)         | 05/86 → | 92    |                                   |  | 901 876 | 902 908 |
| Rocky 4WD 2.0       | (F70,F80,F90) | 04/84 → | 94    |                                   |  | 901 445 | 902 443 |
| Rocky 4WD 2.0       | (F77,F87,F97) | 04/84 → | 94    |                                   |  | 901 445 | 902 855 |
| Rocky 4WD 2.5 D     | (F50, F60)    | 04/84 → | 10/88 |                                   |  | 901 445 | -       |
| Rocky 4WD 2.8 D/TD  | (F70, F75)    | 84 →    | 98    |                                   |  | 901 445 | 902 443 |
| Rocky 4WD 2.8 D/TD  | (F80, F85)    | 84 →    | 98    |                                   |  | 901 445 | 902 443 |
| Rocky 4WD 2.8 TD    | (F73,F78,F98) | 05/93 → | 98    |                                   |  | 901 445 | 902 855 |
| Scat                |               | 84 →    | 10/88 |                                   |  | 901 445 | -       |
| Taft 1.6            | (F20, F25)    | 83 →    | 10/88 |                                   |  | 901 445 | -       |
| Taft 2.5 Diesel     | (F50, F55)    | 83 →    | 10/88 |                                   |  | 901 445 | -       |
| Taft 2.8 Diesel     | (F60, F65)    | 83 →    | 10/88 |                                   |  | 901 445 | -       |
| Zebra               | (S88, S89)    | 88 →    | 91    |                                   |  | 901 885 | -       |



| MODELL/MODEL/MODELE |  | BEMERKUNGEN/REMARKS/<br>REMARQUES |  |  |
|---------------------|---|-----------------------------------|---|---|
| Daimler 4.2         | 84 → 86   |                                   | 881 564   | 882 666   |
| Double Six 5.3      | 77 → 86   |                                   | 881 564   | 882 666   |
| Limousine DS420     | 77 → 84   |                                   | 881 564   | 882 666   |
| Limousine 4.2       | 85 → 90   |                                   | 881 564   | 882 666   |
| Sovereign 4.2       | 77 → 83   |                                   | 881 564   | 882 666   |



| MODELL/MODEL/MODELE |  <b>BEMERKUNGEN/REMARKS/<br/>REMARQUES</b> |  |
|---------------------|---|---|
| Caravan             | 89 → 95  15"                               | 991 898 -   |

| MODELL/MODEL/MODELE    |  | BEMERKUNGEN/REMARKS/<br>REMARQUES  |  |  |
|------------------------|---|--|---|---|
| 126                    | 77 → 00   |   | 801 538   | 802 464   |
| 126                    | 77 → 00   |   | 801 173   | 802 464   |
| 127                    | 76 → 86   | Ch.1573629→  | 800 408   | 802 318   |
| 128                    | 80 → 84   | Ch.2511998→  | 800 304   | 802 318   |
| 131                    | 75 → 84   |  | 801 698   | 802 480   |
| 132                    | 72 → 81   |   | 801 402   | 802 480   |
| 132                    | 72 → 81   |   | 801 171   | 802 480   |
| Argenta                | 81 → 85   |   | 801 402   | 802 480   |
| Argenta                | 81 → 85   |   | 801 171   | 802 480   |
| Barchetta 1.8 16V      | 95 → 04   | <del>ABS</del>   | 800 398   | 802 330   |
| Barchetta 1.8 16V      | 96 → 05/99  | ABS Ch.→0043319  | 800 398   | 802 315   |
| Barchetta 1.8 16V      | 05/99 → 05  | ABS - Active Sensor Bearing Ch.0043320→  | 801 838   | 802 839   |
| Brava 1.2 16V          | 99 → 01   | <del>ABS</del>   | 801 362   | 802 330   |
| Brava 1.2 16V          | 99 → 01   | ABS - Active Sensor Bearing  | 801 836   | 802 839   |
| Brava 1.4 12V          | 95 → 98   | <del>ABS</del>   | 801 362   | 802 330   |
| Brava 1.4 12V          | 95 → 98   | ABS  | 801 362   | 802 315   |
| Brava 1.6 16V          | 95 → 09/98  | <del>ABS</del>   | 801 362   | 802 330   |
| Brava 1.6 16V          | 95 → 09/98  | ABS  | 801 362   | 802 315   |
| Brava 1.6 16V          | 10/98 → 01  | <del>ABS</del> Man.GBX                  | 801 362   | 802 330   |
| Brava 1.6 16V          | 10/98 → 01  | <del>ABS</del> Man.GBX                  | 800 398   | 802 330   |
| Brava 1.6 16V          | 10/98 → 01  | <del>ABS</del> Aut.GBX   | 801 362   | 802 330   |
| Brava 1.6 16V          | 10/98 → 01  | ABS - Active Sensor Bearing Man.GBX   | 801 836   | 802 839   |
| Brava 1.6 16V          | 10/98 → 01  | ABS - Active Sensor Bearing Man.GBX  | 801 838   | 802 839   |
| Brava 1.6 16V          | 10/98 → 01  | ABS - Active Sensor Bearing Aut.GBX  | 801 836   | 802 839   |
| Brava 1.8 GT 16V       | 95 → 09/98  | <del>ABS</del>   | 800 398   | 802 330   |
| Brava 1.8 GT 16V       | 95 → 09/98  | ABS  | 800 398   | 802 315   |
| Brava 1.8 GT 16V       | 10/98 → 01  | <del>ABS</del>   | 800 398   | 802 330   |
| Brava 1.8 GT 16V       | 10/98 → 01  | ABS - Active Sensor Bearing  | 801 838   | 802 839   |
| Brava 1.9 Diesel       | 95 → 98   | <del>ABS</del>   | 801 362   | 802 330   |
| Brava 1.9 Diesel       | 95 → 98   | ABS  | 801 362   | 802 315   |
| Brava 1.9 Turbo Diesel | 95 → 09/98  | <del>ABS</del>   | 800 398   | 802 330   |
| Brava 1.9 Turbo Diesel | 95 → 09/98  | ABS  | 800 398   | 802 315   |
| Brava 1.9 Turbo Diesel | 10/98 → 01  | <del>ABS</del>   | 800 398   | 802 330   |
| Brava 1.9 Turbo Diesel | 10/98 → 01  | ABS - Active Sensor Bearing  | 801 838   | 802 839   |
| Brava 1.9 JTD          | 10/98 → 01  | <del>ABS</del>   | 800 398   | 802 330   |
| Brava 1.9 JTD          | 10/98 → 01  | ABS - Active Sensor Bearing  | 801 838   | 802 839   |
| Bravo 1.2 16V          | 99 → 01   | <del>ABS</del>   | 801 362   | 802 330   |
| Bravo 1.2 16V          | 99 → 01   | ABS - Active Sensor Bearing  | 801 836   | 802 839   |
| Bravo 1.4 12V          | 95 → 98   | <del>ABS</del>   | 801 362   | 802 330   |
| Bravo 1.4 12V          | 95 → 98   | ABS  | 801 362   | 802 315   |
| Bravo 1.6 16V          | 95 → 09/98  | <del>ABS</del>   | 801 362   | 802 330   |
| Bravo 1.6 16V          | 95 → 09/98  | ABS  | 801 362   | 802 315   |
| Bravo 1.6 16V          | 10/98 → 01  | <del>ABS</del> Man.GBX <del>Mot. Brazil</del>  | 801 362   | 802 330   |
| Bravo 1.6 16V          | 10/98 → 01  | <del>ABS</del> Man.GBX Mot.Brazil  | 800 398   | 802 330   |
| Bravo 1.6 16V          | 10/98 → 01  | <del>ABS</del> Aut.GBX   | 801 362   | 802 330   |
| Bravo 1.6 16V          | 10/98 → 01  | ABS - Active Sensor Bearing Man.GBX <del>Mot. Brazil</del>   | 801 836   | 802 839   |
| Bravo 1.6 16V          | 10/98 → 01  | ABS - Active Sensor Bearing Man.GBX Mot.Brazil   | 801 838   | 802 839   |
| Bravo 1.6 16V          | 10/98 → 01  | ABS - Active Sensor Bearing Aut.GBX  | 801 836   | 802 839   |
| Bravo 1.8 GT 16V       | 95 → 09/98  | <del>ABS</del>   | 800 398   | 802 330   |
| Bravo 1.8 GT 16V       | 95 → 09/98  | ABS  | 800 398   | 802 315   |
| Bravo 1.8 GT 16V       | 10/98 → 01  | <del>ABS</del>   | 800 398   | 802 330   |
| Bravo 1.8 GT 16V       | 10/98 → 01  | ABS - Active Sensor Bearing  | 801 838   | 802 839   |
| Bravo 1.9 Diesel       | 95 → 98   | <del>ABS</del>   | 801 362   | 802 330   |
| Bravo 1.9 Diesel       | 95 → 98   | ABS  | 801 362   | 802 315   |

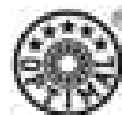



## MODELL/MODEL/MODELE



## BEMERKUNGEN/REMARKS/ REMARQUES



| MODELL/MODEL/MODELE            |               | BEMERKUNGEN/REMARKS/<br>REMARQUES |         |         |
|--------------------------------|---------------|-----------------------------------|---------|---------|
| Bravo 1.9 Turbo Diesel         | 95 → 09/98    | ABS                               | 800 398 | 802 330 |
| Bravo 1.9 Turbo Diesel         | 95 → 09/98    | ABS                               | 800 398 | 802 315 |
| Bravo 1.9 Turbo Diesel         | 10/98 → 01    | ABS                               | 800 398 | 802 330 |
| Bravo 1.9 Turbo Diesel         | 10/98 → 01    | ABS - Active Sensor Bearing       | 801 838 | 802 839 |
| Bravo 1.9 JTD                  | 10/98 → 01    | ABS                               | 800 398 | 802 330 |
| Bravo 1.9 JTD                  | 10/98 → 01    | ABS - Active Sensor Bearing       | 801 838 | 802 839 |
| Bravo 2.0 HGT 20V              | 95 → 09/98    | ABS                               | 801 500 | 802 330 |
| Bravo 2.0 HGT 20V              | 95 → 09/98    | ABS                               | 801 500 | 802 315 |
| Bravo 2.0 HGT 20V              | 10/98 → 01    | ABS - Active Sensor Bearing       | 801 972 | 802 839 |
| Cinquecento                    | 91 → 98       |                                   | 801 450 | 802 324 |
| Coupé 1.8 16V                  | 94 → 05       | ABS                               | 800 398 | 802 330 |
| Coupé 1.8 16V                  | 94 → 05       | ABS                               | 800 398 | 802 378 |
| Coupé 2.0 16V, 2.0 20V         | 94 → 05       | ABS                               | 800 398 | 802 330 |
| Coupé 2.0 16V, 2.0 20V         | 94 → 05       | ABS                               | 800 398 | 802 378 |
| Coupé 2.0 16V Turbo            | 94 → 96       | ABS                               | 801 500 | 802 330 |
| Coupé 2.0 16V Turbo            | 94 → 96       | ABS                               | 801 500 | 802 378 |
| Coupé 2.0 20V Turbo            | 96 → 05       | ABS                               | 801 500 | 802 330 |
| Coupé 2.0 20V Turbo            | 96 → 05       | ABS                               | 801 500 | 802 378 |
| Croma 1.6 CHT                  | 86 → 90       |                                   | 800 400 | 802 368 |
| Croma (194) 1.8 16V            | 12/05 → 12/06 |                                   | -       | 202 519 |
| Croma 1.9 Turbo Diesel         | 86 → 11/92    | ABS Ch.→2025078                   | 800 400 | 802 368 |
| Croma 1.9 Turbo Diesel         | 86 → 11/92    | ABS Ch.→2025078 ⚙ 90              | 800 400 | 802 370 |
| Croma 1.9 Turbo Diesel         | 11/92 → 96    | ABS Ch.2025079→                   | 801 500 | 802 368 |
| Croma 1.9 Turbo Diesel         | 11/92 → 96    | ABS Ch.2025079→ ⚙ 44              | 801 500 | 802 526 |
| Croma (194) 1.9 D Multijet     | 06/05 → 12/06 |                                   | -       | 202 519 |
| Croma 2.0 CHT                  | 86 → 92       | ABS                               | 800 400 | 802 368 |
| Croma 2.0 CHT                  | 86 → 90       | ABS Ch.→285588 ⚙ 90               | 800 400 | 802 370 |
| Croma 2.0 CHT                  | 91 → 92       | ABS Ch.285589→ ⚙ 44               | 800 400 | 802 526 |
| Croma 2.0 i.e., 2.0 i.e. Turbo | 86 → 11/92    | ABS Ch.→2025078                   | 800 400 | 802 368 |
| Croma 2.0 i.e., 2.0 i.e. Turbo | 86 → 11/92    | ABS Ch.→2025078 ⚙ 90              | 800 400 | 802 370 |
| Croma 2.0 i.e., 2.0 i.e. Turbo | 11/92 → 96    | ABS Ch.2025079→                   | 801 500 | 802 368 |
| Croma 2.0 i.e., 2.0 i.e. Turbo | 11/92 → 96    | ABS Ch.2025079→ ⚙ 44              | 801 500 | 802 526 |
| Croma 2.0 16V                  | 93 → 96       | ABS                               | 801 500 | 802 368 |
| Croma 2.0 16V                  | 93 → 96       | ABS ⚙ 44                          | 801 500 | 802 526 |
| Croma (194) 2.2 16V            | 06/05 → 12/06 |                                   | -       | 202 519 |
| Croma (194) 2.4 D Multijet     | 06/05 → 12/06 |                                   | -       | 202 519 |
| Croma 2.5 Diesel               | 86 → 90       | ABS                               | 800 400 | 802 368 |
| Croma 2.5 Diesel               | 86 → 90       | ABS ⚙ 90                          | 800 400 | 802 370 |
| Croma 2.5 Turbo Diesel         | 86 → 11/92    | ABS Ch.→2025078                   | 800 400 | 802 368 |
| Croma 2.5 Turbo Diesel         | 86 → 11/92    | ABS Ch.→2025078 ⚙ 90              | 800 400 | 802 370 |
| Croma 2.5 Turbo Diesel         | 11/92 → 96    | ABS Ch.2025079→                   | 801 500 | 802 368 |
| Croma 2.5 Turbo Diesel         | 11/92 → 96    | ABS Ch.2025079→ ⚙ 44              | 801 500 | 802 526 |
| Croma 2.5i V6                  | 93 → 96       | ABS ⚙ 44                          | 801 500 | 802 526 |
| Doblò 1.2 8V                   | 03/01 → 05    | ABS                               | 801 730 | 802 271 |
| Doblò 1.2 8V                   | 03/01 → 05    | ABS - Active Sensor Bearing       | 801 838 | 802 980 |
| Doblò 1.3 JTD                  | 05/04 → 05    | ABS                               | 800 398 | 802 271 |
| Doblò 1.3 JTD                  | 05/04 → 05    | ABS - Active Sensor Bearing       | 801 838 | 802 980 |
| Doblò 1.6 16V                  | 03/01 → 05    | ABS                               | 801 730 | 802 271 |
| Doblò 1.6 16V                  | 03/01 → 05    | ABS - Active Sensor Bearing       | 801 838 | 802 980 |
| Doblò 1.9 D                    | 03/01 → 05    | ABS                               | 801 730 | 802 271 |
| Doblò 1.9 D                    | 03/01 → 05    | ABS - Active Sensor Bearing       | 801 838 | 802 980 |
| Doblò 1.9 JTD                  | 10/01 → 05    | ABS                               | 800 398 | 802 271 |
| Doblò 1.9 JTD                  | 10/01 → 05    | ABS - Active Sensor Bearing       | 801 838 | 802 980 |
| Duna 60 1.1                    | 87 → 03/88    | Ch.→7344312, →3403007             | 800 304 | 802 318 |

| MODELL/MODEL/MODELE         |          |  | BEMERKUNGEN/REMARKS/<br>REMARQUES                 |  |  |
|-----------------------------|----------|---|---|---|---|
| Ducato                      | serie I  | - → 85  |   | 04-P207   | -   |
| Duna 60 1.1                 |          | 03/88 → 93  | Ch.7344313→, 3403008→                             | 800 366   | 802 318   |
| Ducato                      | serie II | 85 → 89   |   | 04-P183   | -   |
| Duna 70 1.3                 |          | 87 → 03/88  | Ch.→7344312, →3403007                             | 800 304   | 802 318   |
| Duna 70 1.3                 |          | 03/88 → 93  | Ch.7344313→, 3403008→                             | 800 366   | 802 318   |
| Duna DS 1.7                 |          | 87 → 03/88  | Ch.→7344312, →3403007                             | 800 304   | 802 318   |
| Duna DS 1.7                 |          | 03/88 → 93  | Ch.7344313→, 3403008→                             | 800 366   | 802 318   |
| Duna Citvan                 |          | 87 → 03/88  | Ch.→7344312, →3403007                             | 800 304   | -   |
| Duna Citvan                 |          | 03/88 → 93  | Ch.7344313→, 3403008→                             | 800 366   | -   |
| Duna Penny                  |          | 87 → 03/88  | Ch.→7344312, →3403007                             | 800 304   | -   |
| Duna Penny                  |          | 03/88 → 93  | Ch.7344313→, 3403008→                             | 800 366   | -   |
| Duna Weekend                |          | 87 → 03/88  | Ch.→7344312, →3403007                             | 800 304   | 802 318   |
| Duna Weekend                |          | 03/88 → 93  | Ch.7344313→, 3403008→                             | 800 366   | 802 318   |
| Fiorino 1050                |          | 79 → 87   |   | 800 304   | -   |
| Fiorino 1.1                 |          | 87 → 03/88  | Ch.→8051673                                       | 800 304   | -   |
| Fiorino 1.1                 |          | 03/88 → 06/93   | Ch.8051674→                                       | 800 366   | -   |
| Fiorino 1.3                 |          | 79 → 03/88  | Ch.8817482→8051673                                | 800 304   | -   |
| Fiorino 1.3                 |          | 03/88 → 06/93   | Ch.8051674→                                       | 800 366   | -   |
| Fiorino 1.3                 |          | 07/93 → 01  | <del>ABS</del>                                    | 801 730   | 802 601   |
| Fiorino 1.3                 |          | 07/93 → 01  | ABS   | 801 730   | -   |
| Fiorino 1.3 Diesel          |          | 87 → 03/88  | Ch.→8051673                                       | 800 304   | -   |
| Fiorino 1.3 Diesel          |          | 03/88 → 06/93   | Ch.8051674→                                       | 800 366   | -   |
| Fiorino 1.4                 |          | 07/93 → 01  | <del>ABS</del>                                    | 801 730   | 802 601   |
| Fiorino 1.4                 |          | 07/93 → 01  | ABS   | 801 730   | -   |
| Fiorino 1.5                 |          | 87 → 03/88  | Ch.→8051673                                       | 800 304   | -   |
| Fiorino 1.5                 |          | 03/88 → 06/93   | Ch.8051674→                                       | 800 366   | -   |
| Fiorino 1.6                 |          | 07/93 → 01  | <del>ABS</del>                                    | 801 730   | 802 601   |
| Fiorino 1.6                 |          | 07/93 → 01  | ABS   | 801 730   | -   |
| Fiorino 1.7 Diesel          |          | 87 → 03/88  | Ch.→8051673                                       | 800 304   | -   |
| Fiorino 1.7 Diesel          |          | 03/88 → 06/93   | Ch.8051674→                                       | 800 366   | -   |
| Fiorino 1.7 Diesel          |          | 07/93 → 01  | <del>ABS</del>                                    | 801 730   | 802 601   |
| Fiorino 1.7 Diesel          |          | 07/93 → 01  | ABS   | 801 730   | -   |
| Fiorino 1.7 Turbo Diesel    |          | 07/93 → 01  | <del>ABS</del>                                    | 801 730   | 802 601   |
| Fiorino 1.7 Turbo Diesel    |          | 07/93 → 01  | ABS   | 801 730   | -   |
| Grande Punto 1.2 8V         |          | 10/05 → 12/05   |   | 801 836   | -   |
| Grande Punto 1.3 D Multijet |          | 10/05 → 12/05   |   | 801 836   | -   |
| Grande Punto 1.4 16V        |          | 10/05 → 12/05   |   | 801 836   | -   |
| Grande Punto 1.9 D Multijet |          | 10/05 → 12/05   |   | 801 836   | -   |
| Idea 1.3 JTD                |          | 01/04 → 05  | ABS - Active Sensor Bearing                       | 801 838   | 802 839   |
| Idea 1.3 D Multijet         |          | 10/05 → 12/05   | ABS - Active Sensor Bearing                       | 801 838   | 802 839   |
| Idea 1.2 16V                |          | 01/04 → 05  | ABS - Active Sensor Bearing                       | 801 838   | 802 839   |
| Idea 1.4                    |          | 01/04 → 05  | ABS - Active Sensor Bearing                       | 801 836   | 802 839   |
| Idea 1.9 JTD                |          | 01/04 → 05  | ABS - Active Sensor Bearing                       | 801 838   | 802 839   |
| Marea 1.2 12V               |          | 99 → 05   | <del>ABS</del>                                    | 801 362   | 802 330   |
| Marea                       |          | 99 → 02   |   | 04-P183   | -   |
| Marea 1.2 12V               |          | 99 → 05   | ABS - Active Sensor Bearing                       | 801 836   | 802 839   |
| Marea 1.4 12V               |          | 96 → 05   | <del>ABS</del>                                    | 801 362   | 802 330   |
| Marea 1.4 12V               |          | 96 → 98   | ABS Ch.→0176271, →5054833, →0180746               | 801 362   | 802 315   |
| Marea 1.4 12V               |          | 98 → 05   | ABS - Active Sensor Bearing Ch.0176272→, 0180747→ | 801 836   | 802 839   |
| Marea 1.4 12V               |          | 98 → 05   | ABS - Active Sensor Bearing Ch.5054834→           | 801 836   | 802 839   |
| Marea 1.6 16V               |          | 96 → 05   | <del>ABS</del>                                    | 800 398   | 802 330   |
| Marea 1.6 16V               |          | 96 → 98   | ABS Ch.→0176271, →5054833, →0180746               | 800 398   | 802 315   |
| Marea 1.6 16V               |          | 98 → 05   | ABS - Active Sensor Bearing Ch.0176272→, 0180747→ | 801 838   | 802 839   |
| Marea 1.6 16V               |          | 98 → 05   | ABS - Active Sensor Bearing Ch.5054834→           | 801 838   | 802 839   |







## MODELL/MODEL/MODELE



## BEMERKUNGEN/REMARKS/ REMARQUES



|                              |            |   |         |         |
|------------------------------|------------|---|---------|---------|
| Marea 1.8 16V                | 96 → 05    | <del>ABS</del>                                    | 800 398 | 802 330 |
| Marea 1.8 16V                | 96 → 98    | ABS Ch.→0176271, →5054833, →0180746               | 800 398 | 802 315 |
| Marea 1.8 16V                | 98 → 05    | ABS - Active Sensor Bearing Ch.0176272→, 0180747→ | 801 838 | 802 839 |
| Marea 1.8 16V                | 98 → 05    | ABS - Active Sensor Bearing Ch.5054834→           | 801 838 | 802 839 |
| Marea 1.9 Turbo Diesel       | 96 → 05    | <del>ABS</del>                                    | 800 398 | 802 330 |
| Marea 1.9 Turbo Diesel       | 96 → 98    | ABS Ch.→0176271, →5054833, →0180746               | 800 398 | 802 315 |
| Marea 1.9 Turbo Diesel       | 98 → 05    | ABS - Active Sensor Bearing Ch.0176272→, 0180747→ | 801 838 | 802 839 |
| Marea 1.9 Turbo Diesel       | 98 → 05    | ABS - Active Sensor Bearing Ch.5054834→           | 801 838 | 802 839 |
| Marea 1.9 JTD                | 98 → 05    | <del>ABS</del>                                    | 800 398 | 802 330 |
| Marea 1.9 JTD                | 98 → 05    | ABS - Active Sensor Bearing                       | 801 838 | 802 839 |
| Marea 2.0 20V, 2.0 20V Turbo | 96 → 05    | <del>ABS</del>                                    | 801 500 | 802 330 |
| Marea 2.0 20V, 2.0 20V Turbo | 96 → 98    | ABS Ch.→0176271, →5054833, →0180746               | 801 500 | 802 315 |
| Marea 2.0 20V, 2.0 20V Turbo | 98 → 05    | ABS - Active Sensor Bearing Ch.0176272→, 0180747→ | 801 972 | 802 839 |
| Marea 2.0 20V, 2.0 20V Turbo | 98 → 05    | ABS - Active Sensor Bearing Ch.5054834→           | 801 972 | 802 839 |
| Marea 2.4 Turbo Diesel       | 96 → 99    | <del>ABS</del>                                    | 801 500 | 802 330 |
| Marea 2.4 Turbo Diesel       | 96 → 98    | ABS Ch.→0176271, →5054833, →0180746               | 801 500 | 802 315 |
| Marea 2.4 Turbo Diesel       | 98 → 99    | ABS - Active Sensor Bearing Ch.0176272→, 0180747→ | 801 972 | 802 839 |
| Marea 2.4 Turbo Diesel       | 98 → 99    | ABS - Active Sensor Bearing Ch.5054834→           | 801 972 | 802 839 |
| Marea 2.4 JTD                | 99 → 05    | <del>ABS</del>                                    | 801 500 | 802 330 |
| Marea 2.4 JTD                | 99 → 05    | ABS - Active Sensor Bearing                       | 801 972 | 802 839 |
| Multipla                     | 98 → -     |   | 04-P183 | -       |
| Multipla                     | 99 → 05    | <del>ABS</del>                                    | 800 398 | 802 330 |
| Multipla                     | 99 → 05    | ABS - Active Sensor Bearing                       | 801 838 | 802 839 |
| Palio                        | 97 → 05    | <del>ABS</del>                                    | 801 880 | 802 330 |
| Palio                        | 97 → 09/01 | ABS   | 801 880 | 802 315 |
| Palio                        | 09/01 → 05 | ABS - Active Sensor Bearing                       | 801 269 | 802 839 |
| Palio Weekend                | 97 → 05    | <del>ABS</del>                                    | 801 880 | 802 330 |
| Palio Weekend                | 97 → 09/01 | ABS   | 801 880 | 802 315 |
| Palio Weekend                | 09/01 → 05 | ABS - Active Sensor Bearing                       | 801 269 | 802 839 |
| Panda 650                    | 81 → 85    |   | 801 342 | 802 394 |
| Panda 650                    | 86 → 04    |   | 801 342 | 802 324 |
| Panda 750                    | 86 → 97    |   | 801 342 | 802 324 |
| Panda 800                    | 81 → 85    |   | 801 342 | 802 394 |
| Panda 900                    | 80 → 85    |   | 801 342 | 802 394 |
| Panda 900                    | 86 → 96    |   | 801 342 | 802 324 |
| Panda 950                    | 80 → 94    |   | 801 342 | 802 394 |
| Panda 1000                   | 85 → 85    |   | 801 342 | 802 394 |
| Panda 1000                   | 86 → 92    |   | 801 342 | 802 324 |
| Panda 1000 i.e. CAT          | 87 → 98    |   | 801 342 | 802 324 |
| Panda 1100                   | 86 → 04    |   | 801 342 | 802 324 |
| Panda 1300 D                 | 86 → 93    |   | 801 342 | 802 324 |
| Panda Van                    | 86 → 04    |   | 801 342 | 802 324 |
| Panda 4x4                    | 83 → 04    |   | 801 342 | 802 444 |
| Panda II 1.1                 | 03 → 06    | <del>ABS</del>                                    | 801 450 | 802 330 |
| Panda II 1.1                 | 03 → 06    | ABS   | 801 950 | 802 839 |
| Panda II 1.2                 | 03 → 06    | <del>ABS</del>                                    | 801 450 | 802 330 |
| Panda II 1.2                 | 03 → 06    | ABS   | 801 950 | 802 839 |
| Panda II 1.2 4x4             | 04 → 06    |   | 801 838 | 801 950 |
| Panda II 1.3 JTD             | 03 → 06    | <del>ABS</del>                                    | 800 398 | 802 330 |
| Panda II 1.3 JTD             | 03 → 06    | ABS   | 801 838 | 802 839 |
| Panda II 1.3 JTD 4x4         | 04 → 06    |   | 801 838 | 801 950 |
| Punto I 55 1.1               | 93 → 99    | <del>ABS</del>                                    | 801 364 | 802 330 |
| Punto                        | 99 → -     |   | 04-P183 | -       |
| Punto I 55 1.1               | 93 → 99    | ABS   | 801 364 | 802 315 |

| MODELL/MODEL/MODELE      |  | BEMERKUNGEN/REMARKS/<br>REMARQUES   |  |  |
|--------------------------|---|---|---|---|
| Punto I 60 1.2           | 93 → 06/00  | <del>ABS</del>  | 801 362   | 802 330   |
| Punto I 60 1.2           | 93 → 06/00  | ABS   | 801 362   | 802 315   |
| Punto I 75 1.2 8V        | 93 → 06/00  | <del>ABS</del>  | 801 362   | 802 330   |
| Punto I 75 1.2 8V        | 93 → 06/00  | ABS   | 801 362   | 802 315   |
| Punto I 85 1.2 16V       | 97 → 06/00  | <del>ABS</del>  | 801 362   | 802 330   |
| Punto I 85 1.2 16V       | 97 → 06/00  | ABS   | 801 362   | 802 315   |
| Punto I 1.4 GT Turbo     | 93 → 09/99  | <del>ABS</del>  | 800 398   | 802 330   |
| Punto I 1.4 GT Turbo     | 93 → 09/99  | ABS   | 800 398   | 802 315   |
| Punto I 90 1.6           | 93 → 98   | <del>ABS</del>  | 801 362   | 802 330   |
| Punto I 90 1.6           | 93 → 98   | ABS   | 801 362   | 802 315   |
| Punto I 1.7 D            | 94 → 00   | <del>ABS</del>  | 801 362   | 802 330   |
| Punto I 1.7 D            | 94 → 00   | ABS   | 801 362   | 802 315   |
| Punto I 1.7 TD 46 kW     | 96 → 09/99  | <del>ABS</del>  | 801 362   | 802 330   |
| Punto I 1.7 TD 46 kW     | 96 → 09/99  | ABS   | 801 362   | 802 315   |
| Punto I 1.7 TD 51 kW     | 94 → 09/99  | <del>ABS</del>  | 800 398   | 802 330   |
| Punto I 1.7 TD 51 kW     | 94 → 09/99  | ABS   | 800 398   | 802 315   |
| Punto I 1.7 TD 52 kW     | 94 → 00   | <del>ABS</del>  | 800 398   | 802 330   |
| Punto I 1.7 TD 52 kW     | 94 → 00   | ABS   | 800 398   | 802 315   |
| Punto I Cabriolet        | 93 → 06/00  | <del>ABS</del>  | 801 362   | 802 330   |
| Punto I Cabriolet        | 93 → 06/00  | ABS   | 801 362   | 802 315   |
| Punto II 1.2 8V, 1.2 16V | 09/99 → 06  | <del>ABS</del>  | 801 362   | 802 330   |
| Punto II 1.2 8V, 1.2 16V | 09/99 → 06  | ABS - Active Sensor Bearing   | 801 836   | 802 839   |
| Punto II 1.3 JTD         | 03 → 06   | <del>ABS</del>  | 800 398   | 802 330   |
| Punto II 1.3 JTD         | 03 → 06   | ABS - Active Sensor Bearing   | 801 838   | 802 839   |
| Punto II 1.4 16V         | 03 → 06   | <del>ABS</del>  | 801 362   | 802 330   |
| Punto II 1.4 16V         | 03 → 06   | ABS - Active Sensor Bearing   | 801 836   | 802 839   |
| Punto II 1.8 16V HGT     | 09/99 → 06  | <del>ABS</del>  | 800 398   | 802 330   |
| Punto II 1.8 16V HGT     | 09/99 → 06  | ABS - Active Sensor Bearing   | 801 838   | 802 839   |
| Punto II 1.9 DS.         | 09/99 → 06  | <del>ABS</del>  | 801 362   | 802 330   |
| Punto II 1.9 DS.         | 09/99 → 06  | ABS - Active Sensor Bearing   | 801 836   | 802 839   |
| Punto II 1.9 JTD         | 01 → 06   | <del>ABS</del>  | 800 398   | 802 330   |
| Punto II 1.9 JTD         | 01 → 06   | ABS - Active Sensor Bearing   | 801 838   | 802 839   |
| Regata 1.3, 1.5, 1.6     | 83 → 05/84  |   | 800 304   | 802 318   |
| Regata 1.3, 1.5, 1.6     | 06/84 → 03/88   | Ch.→7292150   | 800 304   | 802 324   |
| Regata 1.3, 1.5, 1.6     | 03/88 → 90  | Ch.7292151→   | 800 366   | 802 324   |
| Regata 1.7 Diesel        | 86 → 03/88  | Ch.→7292150   | 800 304   | 802 324   |
| Regata 1.7 Diesel        | 03/88 → 90  | Ch.7292151→   | 800 366   | 802 324   |
| Regata 1.9 Diesel        | 86 → 03/88  | Ch.→7292150   | 800 304   | 802 324   |
| Regata 1.9 Diesel        | 03/88 → 90  | Ch.7292151→   | 800 366   | 802 324   |
| Regata Weekend           | 85 → 03/88  | Ch.→7292150   | 800 304   | -   |
| Regata Weekend           | 03/88 → 90  | Ch.7292151→   | 800 366   | -   |
| Ritmo 60, 65, 70, 75, 85 | 78 → 05/84  |   | 800 304   | 802 318   |
| Ritmo 60, 65, 70, 75, 85 | 06/84 → 87  |   | 800 304   | 802 324   |
| Ritmo 105 TC 1.6         | 78 → 05/84  |   | 800 304   | 802 318   |
| Ritmo 105 TC 1.6         | 06/84 → 87  |   | 800 304   | 802 324   |
| Ritmo 125 TC 2.0         | 82 → 87   |  | 801 372   | -   |
| Ritmo 130 TC 2.0         | 82 → 87   |  | 801 372   | -   |
| Ritmo Diesel 1.7         | 78 → 05/84  |   | 800 304   | 802 318   |
| Ritmo Diesel 1.7         | 06/84 → 87  |   | 800 304   | 802 324   |
| Ritmo Turbo Diesel 1.9   | 78 → 05/84  |   | 800 304   | 802 318   |
| Ritmo Turbo Diesel 1.9   | 06/84 → 87  |   | 800 304   | 802 324   |
| Ducato                   | 89 → -  | 1800 kg   | 04-P181   | -   |
| Ducato serie III         | 89 → -  |   | 04-P205   | -   |
| Ducato                   | 94 → -  | 1000 -1400 kg   | 04-P185   | -   |



















































## BEMERKUNGEN/REMARKS/ REMARQUES





































































| MODELL/MODEL/MODELE     |               |                             |  |         |         |
|-------------------------|---------------|-----------------------------|--|---------|---------|
| Scudo                   | 94 → 06       |                             |  | 681 303 | 682 305 |
| Scudo                   | 02/96 → -     |                             |  | 04-P193 | -       |
| Sedici                  | 06/06 → 12/06 |                             |  | 801 829 | -       |
| Seicento                | 98 → 05       | <del>ABS</del>              |  | 801 450 | 802 324 |
| Seicento                | 98 → 05       | ABS - Active Sensor Bearing |  | 801 950 | 802 605 |
| Seicento Elektra        | 98 → 02       |                             |  | 801 364 | -       |
| Siena                   | 97 → 06       | <del>ABS</del>              |  | 801 880 | 802 330 |
| Siena                   | 97 → 06       | ABS                         |  | 801 880 | 802 315 |
| Stilo 1.2 16V           | 02 → 05       | ABS - Active Sensor Bearing |  | 801 836 | 802 839 |
| Stilo 1.4 16V           | 04 → 05       | ABS - Active Sensor Bearing |  | 801 974 | 802 839 |
| Stilo 1.6 16V           | 01 → 05       | ABS - Active Sensor Bearing |  | 801 974 | 802 839 |
| Stilo 1.8 16V           | 01 → 05       | ABS - Active Sensor Bearing |  | 801 974 | 802 839 |
| Stilo 1.9 JDT           | 01 → 05       | ABS - Active Sensor Bearing |  | 801 974 | 802 839 |
| Stilo 2.4 20V           | 01 → 05       | ABS - Active Sensor Bearing |  | 801 267 | 802 839 |
| Stilo SW 1.4 16V        | 04 → 05       | ABS - Active Sensor Bearing |  | 801 974 | 802 265 |
| Stilo SW 1.6 16V        | 03 → 05       | ABS - Active Sensor Bearing |  | 801 974 | 802 265 |
| Stilo SW 1.8 16V        | 03 → 05       | ABS - Active Sensor Bearing |  | 801 974 | 802 265 |
| Stilo SW 1.9 JDT        | 03 → 05       | ABS - Active Sensor Bearing |  | 801 974 | 802 265 |
| Strada                  | 96 → 04       | <del>ABS</del>              |  | 801 730 | 802 330 |
| Strada                  | 96 → 04       | ABS - Active Sensor Bearing |  | 801 838 | -       |
| Talento                 | 89 → -        |                             |  | 04-P205 | -       |
| Tempra 1.4, 1.6         | 90 → 96       | <del>ABS</del>              |  | 801 376 | 802 330 |
| Tempra 1.4, 1.6         | 90 → 92       | ABS                         |  | 801 376 | 802 330 |
| Tempra 1.4, 1.6         | 93 → 96       | ABS                         |  | 801 376 | 802 378 |
| Tempra 1.6 Automatic    | 90 → 96       | <del>ABS</del>              |  | 801 376 | 802 330 |
| Tempra 1.6 Automatic    | 90 → 92       | ABS                         |  | 801 730 | 802 330 |
| Tempra 1.6 Automatic    | 93 → 96       | ABS                         |  | 801 730 | 802 378 |
| Tempra 1.8 i.e.         | 90 → 96       | <del>ABS</del>              |  | 800 398 | 802 330 |
| Tempra 1.8 i.e.         | 90 → 96       | ABS                         |  | 800 398 | 802 378 |
| Tempra 1.9 Diesel       | 90 → 96       | <del>ABS</del>              |  | 801 376 | 802 330 |
| Tempra 1.9 Diesel       | 90 → 96       | ABS                         |  | 801 376 | 802 378 |
| Tempra 1.9 Turbo Diesel | 90 → 96       | <del>ABS</del>              |  | 800 398 | 802 330 |
| Tempra 1.9 Turbo Diesel | 90 → 96       | ABS                         |  | 800 398 | 802 378 |
| Tempra 2.0 i.e.         | 90 → 96       | <del>ABS</del>              |  | 800 398 | 802 330 |
| Tempra 2.0 i.e.         | 90 → 96       | ABS                         |  | 800 398 | 802 378 |
| Tempra 2.0 i.e. 4x4     | 92 → 96       |                             |  | 800 398 | 800 398 |
| Tipo 1.1, 1.4           | 88 → 95       | <del>ABS</del>              |  | 801 450 | 802 330 |
| Tipo 1.1, 1.4           | 88 → 02/93    | ABS                         |  | 801 450 | 802 330 |
| Tipo 1.1, 1.4           | 03/93 → 95    | ABS                         |  | 801 450 | 802 378 |
| Tipo 1.6                | 88 → 05/89    | <del>ABS</del>              |  | 801 360 | 802 330 |
| Tipo 1.6                | 88 → 05/89    | ABS                         |  | 801 360 | 802 330 |
| Tipo 1.6                | 06/89 → 95    | <del>ABS</del>              |  | 801 376 | 802 330 |
| Tipo 1.6                | 06/89 → 02/93 | ABS                         |  | 801 376 | 802 330 |
| Tipo 1.6                | 03/93 → 95    | ABS                         |  | 801 376 | 802 378 |
| Tipo 1.6 AGT, DGT       | 89 → 05/89    |                             |  | 800 400 | 802 330 |
| Tipo 1.6 AGT, DGT       | 06/89 → 90    |                             |  | 800 398 | 802 330 |
| Tipo 1.6 Automatic      | 91 → 95       | <del>ABS</del>              |  | 801 376 | 802 330 |
| Tipo 1.6 Automatic      | 91 → 95       | ABS                         |  | 801 376 | 802 378 |
| Tipo 1.7 Diesel         | 88 → 05/89    | <del>ABS</del>              |  | 801 360 | 802 330 |
| Tipo 1.7 Diesel         | 06/89 → 95    | <del>ABS</del>              |  | 801 376 | 802 330 |
| Tipo 1.7 Diesel         | 88 → 05/89    | ABS                         |  | 801 360 | 802 330 |
| Tipo 1.7 Diesel         | 06/89 → 03/93 | ABS                         |  | 801 376 | 802 330 |
| Tipo 1.7 Diesel         | 04/93 → 95    | ABS                         |  | 801 376 | 802 378 |
| Tipo 1.8 i.e.           | 91 → 02/93    |                             |  | 800 398 | 802 330 |



































































| MODELL/MODEL/MODELE                            |  | BEMERKUNGEN/REMARKS/<br>REMARQUES  |  |  |
|--|---|--|---|---|
| Tipo 1.8 i.e.                                  | 03/93 → 95  | <del>ABS</del>   | 800 398   | 802 330   |
| Tipo 1.8 i.e.                                  | 03/93 → 95  | ABS  | 800 398   | 802 378   |
| Tipo 1.8 16V Sport                             | 89 → 92   | <del>ABS</del>   | 800 398   | 802 330   |
| Tipo 1.8 16V Sport                             | 89 → 92   | ABS  | 800 398   | 802 378   |
| Tipo 1.9 Diesel                                | 92 → 95   | <del>ABS</del>   | 801 376   | 802 330   |
| Tipo 1.9 Diesel                                | 92 → 03/93  | ABS  | 801 376   | 802 330   |
| Tipo 1.9 Diesel                                | 04/93 → 95  | ABS  | 801 376   | 802 378   |
| Tipo 1.9 Turbo Diesel                          | 88 → 05/89  | <del>ABS</del>   | 800 400   | 802 330   |
| Tipo 1.9 Turbo Diesel                          | 88 → 05/89  | ABS  | 800 400   | 802 378   |
| Tipo 1.9 Turbo Diesel                          | 06/89 → 96  | <del>ABS</del>   | 800 398   | 802 330   |
| Tipo 1.9 Turbo Diesel                          | 06/89 → 96  | ABS  | 800 398   | 802 378   |
| Tipo 2.0 i.e.                                  | 91 → 02/93  |  | 800 398   | 802 330   |
| Tipo 2.0 i.e.                                  | 03/93 → 95  | <del>ABS</del>   | 800 398   | 802 330   |
| Tipo 2.0 i.e.                                  | 03/93 → 95  | ABS  | 800 398   | 802 378   |
| Tipo 2.0 16V Sport                             | 91 → 95   | <del>ABS</del>   | 800 398   | 802 330   |
| Tipo 2.0 16V Sport                             | 91 → 95   | ABS  | 800 398   | 802 378   |
| Ulysse 1.8, 1.9 TD, 2.0, 2.0 16V, 2.0 JTD, 2.0 | 94 → 02   |  | 04-P193   | -   |
| Ulysse I                                       | 94 → 07/02  | ABS  48             | 681 303   | 682 305   |
| Ulysse II 2.0                                  | 08/02 → 05  | ABS - Active Sensor Bearing  | 681 261   | 682 263   |
| Ulysse II 2.0 JTD                              | 08/02 → 05  | ABS - Active Sensor Bearing  | 681 261   | 682 263   |
| Ulysse II 2.2 JTD                              | 08/02 → 05  | ABS - Active Sensor Bearing  | 681 261   | 682 263   |
| Ulysse II 3.0 V6 24V                           | 08/02 → 05  | ABS - Active Sensor Bearing  | 681 259   | 682 263   |
| Uno 45 0.9                                     | 83 → 92   |  | 800 408   | 802 318   |
| Uno 45 1.0                                     | 83 → 93   |  | 800 408   | 802 318   |
| Uno 55 1.1                                     | 83 → 89   |  | 800 408   | 802 318   |
| Uno 60 1.1                                     | 86 → 92   |  | 800 408   | 802 318   |
| Uno CS 1.1                                     | 86 → 03/88  | Ch.→34033006   | 800 304   | 802 318   |
| Uno CS 1.1                                     | 03/88 → 92  | Ch.34033007→   | 800 366   | 802 318   |
| Uno 70 1.3                                     | 83 → 89   |  | 800 408   | 802 318   |
| Uno 1.3 Turbo i.e.                             | 85 → 03/88  | Ch.→7344312  | 800 304   | -   |
| Uno 1.3 Turbo i.e.                             | 03/88 → 92  | Ch.7344313→  | 800 366   | -   |
| Uno 1.3 Super Diesel                           | 83 → 92   |  | 800 408   | 802 318   |
| Uno 70 i.e. 1.4                                | 83 → 93   |  | 800 408   | 802 318   |
| Uno 1.4 Turbo i.e.                             | 03/88 → 96  | Ch.7344313→  | 800 366   | -   |
| Uno 1.4 Turbo Diesel                           | 86 → 03/88  | Ch.→7344766  | 800 304   | 802 318   |
| Uno 1.4 Turbo Diesel                           | 03/88 → 95  | Ch.7344767→  | 800 366   | 802 318   |
| Uno 75 i.e. 1.5                                | 86 → 88   | Ch.→631845   | 800 408   | 802 318   |
| Uno 75 i.e. 1.5                                | 12/88 → 92  | Ch.631846→   | 801 382   | 802 318   |
| Uno 1.7 Diesel                                 | 87 → 03/88  | Ch.→539854   | 800 304   | 802 318   |
| Uno 1.7 Diesel                                 | 03/88 → 95  | Ch.539855→   | 800 366   | 802 318   |
| Uno 1.7 Diesel CS                              | 86 → 03/88  | Ch.→34033006   | 800 304   | 802 318   |
| Uno 1.7 Diesel CS                              | 03/88 → 95  | Ch.34033007→   | 800 366   | 802 318   |
| Uno 1.9 Diesel                                 | 90 → 95   |  | 800 366   | 802 318   |
| X 1/9 Five speed 1.5                           | 79 → 89   |  | 800 304   | 802 954   |
| Ducato I 10                                    | 82 → 86   |  Ch.→278757       | 681 504   | 682 420   |
| Ducato I 10                                    | 82 → 86   |  Ch.→278757       | 681 504   | 682 422   |
| Ducato I 10                                    | 86 → 89   |  Ch.278758→604496 | 681 504   | 682 508   |
| Ducato I 10                                    | 86 → 89   |  Ch.278758→604496 | 681 504   | 682 510   |
| Ducato I 10                                    | 89 → 03/94  |  Ch.604497→       | 681 506   | 682 508   |
| Ducato I 10                                    | 89 → 03/94  |  Ch.604497→       | 681 506   | 682 510   |
| Ducato I 13                                    | 82 → 86   |  Ch.→278757       | 681 504   | 682 420   |
| Ducato I 13                                    | 82 → 86   |  Ch.→278757       | 681 504   | 682 422   |
| Ducato I 13                                    | 86 → 86   |  Ch.278758→       | 681 504   | 682 508   |
| Ducato I 13                                    | 86 → 86   |  Ch.278758→       | 681 504   | 682 510   |























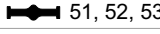









| MODELL/MODEL/MODELE    |  | BEMERKUNGEN/REMARKS/<br>REMARQUES   |  |  |
|------------------------|---|---|---|---|
| Ducato I 14            | 86 → 89   |   Ch.->604496 | 681 504   | 682 508   |
| Ducato I 14            | 86 → 89   |   Ch.->604496 | 681 504   | 682 510   |
| Ducato I 14            | 89 → 03/94  |   Ch.604497→  | 681 506   | 682 508   |
| Ducato I 14            | 89 → 03/94  |   Ch.604497→  | 681 506   | 682 510   |
| Ducato I 18            | 86 → 89   |   Ch.->604496 | 681 504   | 682 492   |
| Ducato I 18            | 86 → 89   |   Ch.->604496 | 681 504   | 682 490   |
| Ducato I 18            | 89 → 03/94  |   Ch.604497→  | 681 506   | 682 492   |
| Ducato I 18            | 89 → 03/94  |   Ch.604497→  | 681 506   | 682 490   |
| Ducato II 10           | 03/94 → 04/02   |    | 681 506   | 682 327   |
| Ducato II 10 4x4       | 96 → 04/02  |    | 681 506   | 681 506   |
| Ducato II 14           | 03/94 → 04/02   |    | 681 506   | 682 327   |
| Ducato II 14 4x4       | 96 → 04/02  |    | 681 506   | 681 506   |
| Ducato II 18           | 03/94 → 04/02   |    | 681 325   | 682 329   |
| Ducato II 18 4x4       | 96 → 04/02  |    | 681 325   | 681 506   |
| Ducato III 1000 kg     | 04/02 → 04/06   |    | 681 375   | 682 437   |
| Ducato III 1000 kg 4x4 | 04/02 → 04/06   |    | 681 375   | -   |
| Ducato III 1500 kg     | 04/02 → 04/06   |    | 681 375   | 682 437   |
| Ducato III 1500 kg 4x4 | 04/02 → 04/06   |    | 681 375   | -   |
| Ducato III 1800 kg     | 04/02 → 04/06   |    | 681 471   | 682 437   |
| Ducato III 1800 kg 4x4 | 04/02 → 04/06   |    | 681 471   | -   |
| Talento                | 89 → 94   |               | 681 506   | 682 508   |
| Talento                | 89 → 94   |               | 681 506   | 682 510   |

| MODELL/MODEL/MODELE                |  | BEMERKUNGEN/REMARKS/<br>REMARQUES  |  |  |
|------------------------------------|---|--|---|---|
| Capri II                           | 74 → 87   |  Köln   | 301 151   | 302 254   |
| Capri II 3000                      | 74 → 87   |  Köln   | 300 004   | 302 254   |
| Cortina 1300, 1600                 | 08/70 → 82  |   | 301 280   | 302 254   |
| Cortina 1300, 1600                 | 08/70 → 82  |   | 301 280   | 302 146   |
| Cortina 2000, 2300                 | 08/70 → 82  |  | 301 280   | 302 146   |
| Cougar                             | 08/98 → 01  | <del>ABS</del>   | 301 182   | 302 186   |
| Cougar 2.0 16V                     | 08/98 → -   |  | 04-P141   | -   |
| Cougar                             | 08/98 → 01  | ABS  | 301 182   | 302 188   |
| Escort                             | 12/74 → 80  |  Köln   | 301 280   | 302 254   |
| Escort                             | 80 → 08/90  |  | 04-P135   | -   |
| Escort III, IV 1.1                 | 81 → 08/90  |                              | 301 018   | 300 004   |
| Escort III, IV 1.1                 | 81 → 08/90  |   | 301 006   | 300 062   |
| Escort III, IV 1.3                 | 81 → 85   |                              | 301 006   | 300 004   |
| Escort III, IV 1.3                 | 81 → 85   |   | 301 006   | 300 062   |
| Escort III, IV 1.3                 | 86 → 08/90  |                              | 301 018   | 300 004   |
| Escort III, IV 1.3                 | 86 → 08/90  |   | 301 018   | 300 062   |
| Escort III, IV 1.4                 | 86 → 08/90  |                              | 301 006   | 300 004   |
| Escort III, IV 1.4                 | 86 → 08/90  |   | 301 006   | 300 062   |
| Escort III, IV 1.6                 | 81 → 08/90  |                              | 301 006   | 300 004   |
| Escort III, IV 1.6                 | 81 → 08/90  |   | 301 006   | 300 062   |
| Escort III, IV 1.6 Diesel          | 81 → 90   |                              | 301 006   | 300 004   |
| Escort III, IV 1.6 Diesel          | 81 → 90   |   | 301 006   | 300 062   |
| Escort III, IV 1.7 Diesel          | 81 → 90   |  | 301 006   | 300 062   |
| Escort III, IV 1.8 Diesel          | 86 → 08/90  |                          | 301 006   | 300 004   |
| Escort III, IV 1.8 Diesel          | 86 → 08/90  |   | 301 006   | 300 062   |
| Escort V, VI, VII 1.3              | 09/90 → 10/91   |                          | 301 180   | 302 058   |
| Escort 1.4, 1.6, 1.8, 2.0, 1.8 D   | 09/90 → 01/95   |  | 04-P139   | -   |
| Escort V, VI, VII 1.6 4x4          | 07/94 → 01/95   |  | 04-P137   | -   |
| Escort V, VI, VII 1.3              | 09/90 → 10/91   |   | 301 180   | 302 248   |
| Escort V, VI, VII 1.3              | 11/91 → 99  |                          | 301 132   | 302 058   |
| Escort 2.0 EFI 16V 4x4             | 01/95 → 09/01   |  | 04-P137   | -   |
| Escort V, VI, VII 1.3              | 11/91 → 99  |   | 301 132   | 302 248   |
| Escort V, VI, VII 1.4, 1.6         | 09/90 → 10/91   |   Man.GBX <del>ABS</del> | 301 180   | 302 058   |
| Escort V, VI, VII 1.4, 1.6         | 09/90 → 10/91   |   Man.GBX ABS            | 301 132   | 302 058   |
| Escort V, VI, VII 1.4, 1.6         | 09/90 → 10/91   |   Aut.GBX                | 301 132   | 302 058   |
| Escort V, VI, VII 1.4, 1.6         | 11/91 → 99  |                          | 301 132   | 302 058   |
| Escort V, VI, VII 1.4, 1.6         | 09/90 → 10/91   |  Man.GBX <del>ABS</del>   | 301 180   | 302 248   |
| Escort V, VI, VII 1.4, 1.6         | 09/90 → 10/91   |  Man.GBX ABS  | 301 132   | 302 248   |
| Escort V, VI, VII 1.4, 1.6         | 09/90 → 10/91   |  Aut.GBX  | 301 132   | 302 248   |
| Escort V, VI, VII 1.4, 1.6         | 11/91 → 99  |   | 301 132   | 302 248   |
| Escort V, VI, VII 1.6 4x4          | 95 → 98   |  | 301 132   | 301 180   |
| Escort V, VI, VII 1.8, 1.8 Diesel  | 09/90 → 99  |                          | 301 132   | 302 058   |
| Escort V, VI, VII 1.8, 1.8 Diesel  | 09/90 → 99  |   | 301 132   | 302 248   |
| Escort V, VI, VII 1.8 XR3i 16V 4x4 | 94 → 00   |  | 301 180   | 301 180   |
| Escort V, VI, VII RS 2000          | 05/91 → 10/91   | Man.GBX <del>ABS</del>   | 301 180   | 302 058   |
| Escort V, VI, VII RS 2000          | 05/91 → 10/91   | Man.GBX ABS  | 301 132   | 302 058   |
| Escort V, VI, VII RS 2000          | 05/91 → 10/91   | Aut.GBX  | 301 132   | 302 058   |
| Escort V, VI, VII RS 2000          | 11/91 → 99  |  | 301 132   | 302 058   |
| Escort V, VI, VII RS 2000 4x4      | 94 → 01/95  |  | 301 180   | 301 180   |
| Escort V, VI, VII RS 2000 4x4      | 02/95 → 98  |  | 301 132   | 301 180   |
| Escort V, VI, VII RS Cosworth 4x4  | 92 → 98   |   | 301 130   | 302 120   |
| Escort V, VI, VII RS Cosworth 4x4  | 92 → 98   |   | 301 130   | 302 122   |
| Fiesta I, II 1.0, 1.1              | 77 → 80   |  | 301 230   | 300 052   |
| Fiesta                             | 01/87 → 88  |  | 04-P135   | -   |

| MODELL/MODEL/MODELE     |  | BEMERKUNGEN/REMARKS/<br>REMARQUES  |  |  |
|-------------------------|---|--|---|---|
| Fiesta I, II 1.0, 1.1   | 81 → 03/89  |  | 301 018   | 300 052   |
| Fiesta                  | 89 → 01/94  |  | 04-P137   | -   |
| Fiesta I, II 1.3        | 78 → 80   |  | 301 232   | 300 052   |
| Fiesta                  | 01/94 → 08/96   |  | 04-P139   | -   |
| Fiesta I, II 1.3        | 81 → 03/89  |  | 301 006   | 300 052   |
| Fiesta I, II 1.4        | 86 → 03/89  |  | 301 006   | 300 052   |
| Fiesta I, II 1.6 XR2    | 81 → 03/89  |  | 301 006   | 300 052   |
| Fiesta I, II 1.6 Diesel | 84 → 03/89  |  | 301 006   | 300 052   |
| Fiesta III              | 04/89 → 01/94   |  | 301 180   | 302 058   |
| Fiesta III, IV          | 02/94 → 01/02   |  | 301 132   | 302 058   |
| Fiesta V 1.3            | 10/01 → 05  | <del>ABS</del>   | 301 039   | 302 057   |
| Fiesta V 1.3            | 10/01 → 05  | ABS  | 301 045   | 302 057   |
| Fiesta V 1.4 16V        | 10/01 → 05  | <del>ABS</del>   | 301 039   | 302 057   |
| Fiesta V 1.4 16V        | 10/01 → 05  | ABS  | 301 045   | 302 057   |
| Fiesta V 1.4 TDCi       | 10/01 → 05  | <del>ABS</del>   | 301 039   | 302 057   |
| Fiesta V 1.4 TDCi       | 10/01 → 05  | ABS  | 301 045   | 302 057   |
| Fiesta V 1.6 16V        | 10/01 → 05  | <del>ABS</del>   | 301 039   | 302 057   |
| Fiesta V 1.6 16V        | 10/01 → 05  | ABS  | 301 045   | 302 057   |
| Fiesta Courier          | 91 → 01/94  |  | 301 180   | 302 260   |
| Fiesta Courier          | 02/94 → 12/94   |  | 301 132   | 302 260   |
| Fiesta Courier          | 95 → 09/02  | <del>ABS</del>   | 301 132   | 302 186   |
| Fiesta Courier          | 95 → 09/02  | ABS  | 301 132   | 302 188   |
| Focus I                 | 08/98 → 10/04   | <del>ABS</del>   | 301 039   | 302 057   |
| Focus I                 | 08/98 → 10/04   | ABS - Active Sensor Bearing  | 301 045   | 302 057   |
| Focus II                | 11/04 → 06  |  | 301 667   | -   |
| Focus C-MAX             | 10/03 → 06  |  | 301 667   | -   |
| Fusion                  | 02 → 06   | <del>ABS</del>   | 301 039   | 302 057   |
| Fusion                  | 02 → 06   | ABS - Active Sensor Bearing  | 301 045   | 302 057   |
| Galaxy                  | 96 → -  |  | 04-P143   | -   |
| Galaxy                  | 05/95 → 05  |  | 131 129   | 132 131   |
| Galaxy 4x4              | 05/95 → 05  |  | 131 129   | 131 129   |
| Granada                 | 12/72 → 04/85   |  | 300 004   | 302 234   |
| Granada                 | 05/85 → 07/92   |                 | 301 244   | 302 120   |
| Granada                 | 05/85 → 07/92   |                 | 301 246   | 302 122   |
| Granada                 | 08/92 → 09/94   |                 | 301 198   | 302 120   |
| Granada                 | 08/92 → 09/94   |                 | 301 200   | 302 122   |
| Granada 4x4             | 10/85 → 10/94   |                 | 301 130   | 302 120   |
| Granada 4x4             | 10/85 → 10/94   |                 | 301 130   | 302 122   |
| Ka                      | 09/96 → 05  |  | 301 132   | 302 058   |
| Ka                      | 09/96 → -   |  | 04-P139   | -   |
| Maverick                | 08/93 → 98  |  | 961 801   | 962 985   |
| Mondeo                  | 93 → 11/00  |  <del>ABS</del> | 301 182   | 302 186   |
| Mondeo                  | 93 → 11/00  |  | 04-P141   | -   |
| Mondeo                  | 93 → 11/00  |  ABS            | 301 182   | 302 188   |
| Mondeo                  | 93 → 97   |                 | 301 182   | 302 192   |
| Mondeo                  | 98 → 11/00  |                 | 301 182   | 302 037   |
| Mondeo 4x4              | 93 → 96   |                 | 301 182   | 302 196   |
| Mondeo 4x4              | 93 → 96   |                 | 301 182   | 302 190   |
| Mondeo III 1.8 16V      | 11/00 → 06  | ABS - Active Sensor Bearing  | 301 183   | 302 197   |
| Mondeo III 1.8 Sci      | 06/03 → 06  | ABS - Active Sensor Bearing  | 301 183   | 302 197   |
| Mondeo III 2.0 16V      | 11/00 → 06  | ABS - Active Sensor Bearing  | 301 183   | 302 197   |
| Mondeo III 2.0 16V DI   | 11/00 → 06  | ABS - Active Sensor Bearing Man.GBX  | 301 183   | 302 197   |
| Mondeo III 2.0 16V DI   | 11/00 → 06  | ABS - Active Sensor Bearing Aut.GBX  | 301 511   | 302 197   |
| Mondeo III 2.0 16V TDDi | 11/00 → 06  | ABS - Active Sensor Bearing Man.GBX  | 301 183   | 302 197   |

| MODELL/MODEL/MODELE                  |  | BEMERKUNGEN/REMARKS/<br>REMARQUES   |  |  |
|--------------------------------------|---|-------------------------------------|---|---|
| Mondeo III 2.0 16V TDDi              | 11/00 → 06  | ABS - Active Sensor Bearing Aut.GBX | 301 511   | 302 197   |
| Mondeo III 2.0 TDCi                  | 10/01 → 06  | ABS - Active Sensor Bearing Man.GBX | 301 183   | 302 197   |
| Mondeo III 2.0 TDCi                  | 10/01 → 06  | ABS - Active Sensor Bearing Aut.GBX | 301 511   | 302 197   |
| Mondeo III 2.2 TDCi                  | 09/04 → 06  | ABS - Active Sensor Bearing         | 301 183   | 302 197   |
| Mondeo III 2.5 V6 24V                | 11/00 → 06  | ABS - Active Sensor Bearing Man.GBX | 301 183   | 302 197   |
| Mondeo III 2.5 V6 24V                | 11/00 → 06  | ABS - Active Sensor Bearing Aut.GBX | 301 511   | 302 197   |
| Mondeo III 3.0 V6 24V                | 09/04 → 06  | ABS - Active Sensor Bearing         | 301 183   | 302 197   |
| Mondeo III 3.0 V6 24V ST220          | 02 → 06   | ABS - Active Sensor Bearing         | 301 183   | 302 197   |
| Orion                                | 80 → 08/80  |                                     | 04-P135   | -   |
| Orion 1.3                            | 83 → 08/90  |                                     | 301 006   | 300 004   |
| Orion 1.4, 1.6, 1.8, 2.0, 1.8 Diesel | 09/90 → 01/95   |                                     | 04-P139   | -   |
| Orion 1.3                            | 09/90 → 12/90   |                                     | 301 180   | 302 058   |
| Orion 1.3                            | 91 → 93   |                                     | 301 132   | 302 058   |
| Orion 1.4                            | 86 → 08/90  |                                     | 301 006   | 300 004   |
| Orion 1.4                            | 09/90 → 12/90   | Man.GBX                             | 301 180   | 302 058   |
| Orion 1.4                            | 09/90 → 12/90   | Aut.GBX                             | 301 132   | 302 058   |
| Orion 1.4                            | 91 → 93   |                                     | 301 132   | 302 058   |
| Orion 1.6                            | 09/90 → 12/90   | Aut.GBX                             | 301 132   | 302 058   |
| Orion 1.6                            | 83 → 08/90  |                                     | 301 006   | 300 004   |
| Orion 1.6                            | 09/90 → 12/90   | Man.GBX                             | 301 180   | 302 058   |
| Orion 1.6 Diesel                     | 83 → 08/90  |                                     | 301 006   | 300 004   |
| Orion 1.6                            | 91 → 93   |                                     | 301 132   | 302 058   |
| Orion 1.8 16V                        | 91 → 93   |                                     | 301 132   | 302 058   |
| Orion 1.8 Diesel                     | 83 → 08/90  |                                     | 301 006   | 300 004   |
| Orion 1.8 Diesel                     | 09/90 → 93  |                                     | 301 132   | 302 058   |
| Orion 2.0 16V                        | 09/90 → 93  |                                     | 301 132   | 302 058   |
| Probe                                | 10/93 → 98  |                                     | 940 371   | 941 862   |
| Puma                                 | 11/97 → -   |                                     | 04-P139   | -   |
| Puma                                 | 06/97 → 04  |                                     | 301 132   | 302 058   |
| Scorpio I                            | 05/85 → 07/92   | ▣—□                                 | 301 244   | 302 120   |
| Scorpio I                            | 05/85 → 07/92   | □—▣                                 | 301 246   | 302 122   |
| Scorpio I                            | 08/92 → 09/94   | ▣—□                                 | 301 198   | 302 120   |
| Scorpio I                            | 08/92 → 09/94   | □—▣                                 | 301 200   | 302 122   |
| Scorpio I 4x4                        | 10/85 → 09/94   | ▣—□                                 | 301 130   | 302 120   |
| Scorpio I 4x4                        | 10/85 → 09/94   | □—▣                                 | 301 130   | 302 122   |
| Scorpio II                           | 10/94 → 04/97   | ▣—□                                 | 301 139   | 302 120   |
| Scorpio II                           | 10/94 → 04/97   | □—▣                                 | 301 141   | 302 122   |
| Scorpio II                           | 05/97 → 98  | ▣—□                                 | 301 139   | 302 067   |
| Scorpio II                           | 05/97 → 98  | □—▣                                 | 301 141   | 302 067   |
| Sierra 1.3                           | 08/82 → 12/82   |                                     | 301 034   | 302 046   |
| Sierra 1.3                           | 01/83 → 08/83   | ▣—□                                 | 301 034   | 302 046   |
| Sierra 1.3                           | 01/83 → 08/83   | □—▣                                 | 301 038   | 302 046   |
| Sierra 1.3                           | 09/83 → 86  | ▣—□                                 | 301 034   | 302 074   |
| Sierra 1.3                           | 09/83 → 86  | □—▣                                 | 301 038   | 302 076   |
| Sierra 1.6                           | 08/82 → 12/82   |                                     | 301 034   | 302 046   |
| Sierra 1.6                           | 01/83 → 08/83   | ▣—□                                 | 301 034   | 302 046   |
| Sierra 1.6                           | 01/83 → 08/83   | □—▣                                 | 301 038   | 302 046   |
| Sierra 1.6                           | 09/83 → 86  | ▣—□                                 | 301 034   | 302 074   |
| Sierra 1.6                           | 09/83 → 86  | □—▣                                 | 301 038   | 302 076   |
| Sierra 1.6                           | 87 → 93   | ABS ▣—□                             | 301 034   | 302 074   |
| Sierra 1.6                           | 87 → 93   | ABS □—▣                             | 301 038   | 302 076   |
| Sierra 1.6                           | 87 → 93   | ABS ▣—□                             | 301 034   | 302 120   |
| Sierra 1.6                           | 87 → 93   | ABS □—▣                             | 301 038   | 302 122   |
| Sierra 1.8                           | 87 → 93   | ABS ▣—□                             | 301 034   | 302 074   |

| MODELL/MODEL/MODELE    |  | BEMERKUNGEN/REMARKS/<br>REMARQUES  |  |  |
|------------------------|---|--|---|---|
| Sierra 1.8             | 87 → 93   | ABS   | 301 038   | 302 076   |
| Sierra 1.8             | 87 → 93   | ABS   | 301 034   | 302 120   |
| Sierra 1.8             | 87 → 93   | ABS   | 301 038   | 302 122   |
| Sierra 2.0             | 08/82 → 12/82   |  | 301 034   | 302 046   |
| Sierra 2.0             | 01/83 → 08/83   |   | 301 034   | 302 046   |
| Sierra 2.0             | 01/83 → 08/83   |   | 301 038   | 302 046   |
| Sierra 2.0             | 09/83 → 86  |   | 301 034   | 302 074   |
| Sierra 2.0             | 09/83 → 86  |   | 301 038   | 302 076   |
| Sierra 2.0             | 87 → 93   | ABS   | 301 034   | 302 074   |
| Sierra 2.0             | 87 → 93   | ABS   | 301 038   | 302 076   |
| Sierra 2.0             | 87 → 93   | ABS   | 301 034   | 302 120   |
| Sierra 2.0             | 87 → 93   | ABS   | 301 038   | 302 122   |
| Sierra 2.3             | 08/82 → 12/82   |  | 301 034   | 302 046   |
| Sierra 2.3             | 01/83 → 08/83   |   | 301 034   | 302 046   |
| Sierra 2.3             | 01/83 → 08/83   |   | 301 038   | 302 046   |
| Sierra 2.3             | 09/83 → 86  |   | 301 034   | 302 074   |
| Sierra 2.3             | 09/83 → 86  |   | 301 038   | 302 076   |
| Sierra 2.3 Diesel      | 08/82 → 12/82   |  | 301 034   | 302 046   |
| Sierra 2.3 Diesel      | 01/83 → 08/83   |   | 301 034   | 302 046   |
| Sierra 2.3 Diesel      | 01/83 → 08/83   |   | 301 038   | 302 046   |
| Sierra 2.3 Diesel      | 09/83 → 86  |   | 301 034   | 302 074   |
| Sierra 2.3 Diesel      | 09/83 → 86  |   | 301 038   | 302 076   |
| Sierra 2.3 Diesel      | 87 → 93   |          | 301 034   | 302 120   |
| Sierra 2.3 Diesel      | 87 → 93   |       | 301 038   | 302 122   |
| Sierra 2.3 Diesel      | 87 → 93   |    | 301 034   | 302 074   |
| Sierra 2.3 Diesel      | 87 → 93   |    | 301 038   | 302 076   |
| Sierra 2.8             | 08/82 → 12/82   |  | 301 034   | 302 046   |
| Sierra 2.8             | 01/83 → 08/83   |   | 301 034   | 302 046   |
| Sierra 2.8             | 01/83 → 08/83   |   | 301 038   | 302 046   |
| Sierra 2.8             | 09/83 → 86  |   | 301 034   | 302 074   |
| Sierra 2.8             | 09/83 → 86  |   | 301 038   | 302 076   |
| Sierra 2.8             | 87 → 93   |   | 301 034   | 302 120   |
| Sierra 2.8             | 87 → 93   |   | 301 038   | 302 122   |
| Sierra 2.9             | 87 → 93   |   | 301 034   | 302 120   |
| Sierra 2.9             | 87 → 93   |   | 301 038   | 302 122   |
| Sierra RS Cosworth     | 86 → 01/90  |   | 301 244   | 302 120   |
| Sierra RS Cosworth     | 86 → 01/90  |   | 301 246   | 302 122   |
| Sierra RS Cosworth 4x4 | 02/90 → 93  |   | 301 130   | 302 120   |
| Sierra RS Cosworth 4x4 | 02/90 → 93  |   | 301 130   | 302 122   |
| Sierra XR 4x4          | 03/85 → 93  |   | 301 130   | 302 120   |
| Sierra XR 4x4          | 03/85 → 93  |   | 301 130   | 302 122   |
| Sport Ka               | 05/03 → 05  |  | 301 132   | 302 058   |
| Street Ka              | 05/03 → 05  |  | 301 132   | 302 058   |
| Taunus 1.3             | 70 → 82   |   | 301 280   | 302 254   |
| Taunus 1.3             | 70 → 82   |   | 301 280   | 302 146   |
| Taunus 1.6             | 70 → 82   |   | 301 280   | 302 254   |
| Taunus 1.6             | 70 → 82   |   | 301 280   | 302 146   |
| Taunus 2.0, 2.3        | 70 → 82   |  | 301 280   | 302 146   |
| P-100                  | CP 04/82 → 87   |   | 300 004   | 302 208   |
| P-100                  | DP 88 → 92  |    | 301 034   | 302 240   |
| P-100                  | DP 88 → 92  |    | 301 038   | 302 240   |
| Transit I FT 80-120    | 78 → 10/85  |   32   | 300 062   | 302 160   |
| Transit I FT 80-120    | 78 → 10/85  |   34   | 300 062   | 302 172   |
| Transit I FT 80-120    | 11/85 → 91  |   34  | 300 062   | 302 176   |

| MODELL/MODEL/MODELE  |       |  | BEMERKUNGEN/REMARKS/<br>REMARQUES   |  |  |  |
|----------------------|-------|---|---|--|---|---|
| Transit I FT 80-120  |       | 11/85 → 91  |  |  34  | 300 062   | 302 174   |
| Transit I FT 80-120  |       | 92 → 07/00  |  |  34   | 301 118   | 302 164   |
| Transit I FT 100 L   |       | 78 → 10/85  |  |  34   | 300 062   | 302 172   |
| Transit I FT 100 L   |       | 11/85 → 91  |  |  | 300 062   | 302 124   |
| Transit I FT 120-190 |       | 78 → 10/85  |  |  51, 52, 53  | 300 062   | 302 162   |
| Transit I FT 130-150 |       | 92 → 07/00  |  |  51   | 301 118   | 302 166   |
| Transit I FT 130-190 |       | 11/85 → 91  |  |  | 300 062   | 302 124   |
| Transit I FT 130-190 |       | 92 → 07/00  |  |  53   | 301 118   | 302 124   |
| Transit I FT 190L    |       | 92 → 07/00  |  |  51   | 301 118   | 302 166   |
| Transit II           | FWD   | 00 → 06/06  |  | ABS  | 301 185   | 302 255   |
| Transit II           | FWD   | 00 → 06/06  |  | ABS  | 301 185   | 302 257   |
| Transit II           | RWD   | 00 → 06/06  |  |   | 301 185   | -   |
| Transit II           | RWD   | 00 → 06/06  |  |   | 301 185   | 302 124   |
| Transit              | Front | 07/06 → 12/06   |  |  | 301 583   | -   |
| Transit              | Front | 07/06 → 12/06   |  |   | 301 585   | -   |
| Transit              | Rear  | 07/06 → 12/06   |  | ABS 0.8 t, 1.3 t   | -   | 302 595   |
| Transit              | Rear  | 07/06 → 12/06   |  | ABS 1.5 t, 1.7 t   | -   | 302 597   |
| Transit              | Rear  | 07/06 → 12/06   |  | ABS  | -   | 302 255   |

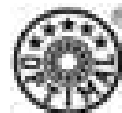









































## BEMERKUNGEN/REMARKS/ REMARQUES











| MODELL/MODEL/MODELE      |          |               |                |         |         |  |
|--------------------------|----------|---------------|----------------|---------|---------|--|
| Accord 1.6               |          | 82 → 83       | Ch.→OC225152   | -       | 912 515 |  |
| Accord 1.6               | (AC)     | 83 → 03/84    | Ch.OC225153→   | -       | 912 515 |  |
| Accord 1.6               | (AC)     | 04/84 → 85    |                | -       | 912 515 |  |
| Accord 1.6               | (CA4)    | 86 → 87       | <del>ABS</del> | 881 704 | 912 532 |  |
| Accord 1.6               | (CA4)    | 86 → 87       | ABS            | 881 704 | -       |  |
| Accord 1.6               | (CA4)    | 88 → 89       |                | 881 704 | 912 532 |  |
| Accord 1.6               | (CA4)    | 88 → 89       | ABS            | 881 704 | 912 532 |  |
| Accord 1.6               | (CA4)    | 88 → 88       | ABS            | 881 704 | -       |  |
| Accord 1.6               | (CA4)    | 89 → 89       | ABS            | 881 704 | 912 518 |  |
| Accord 1.6i 16V          | (CG)     | 10/98 → 03    | ABS            | 911 802 | 912 804 |  |
| Accord 1.8               | (AD)     | 84 → 85       |                | -       | 912 515 |  |
| Accord 1.8               | (AD)     | 84 → 85       |                | -       | 912 473 |  |
| Accord 1.8               | (CB1)    | 90 → 97       |                | 911 385 | 911 387 |  |
| Accord 1.8               | (CB1)    | 90 → 97       | 2WS            | 911 385 | 912 775 |  |
| Accord 1.8               | (CB1)    | 90 → 97       | 4WS            | 911 385 | 912 803 |  |
| Accord 1.8i 16V          | (CG, CH) | 10/98 → 03    | ABS            | 911 802 | 912 804 |  |
| Accord 2.0               | (CA5)    | 86 → 87       | <del>ABS</del> | 881 704 | 912 532 |  |
| Accord 2.0               | (CA5)    | 86 → 87       | ABS            | 881 704 | -       |  |
| Accord 2.0               | (CA5)    | 88 → 89       |                | 881 704 | 912 532 |  |
| Accord 2.0               | (CA5)    | 88 → 89       | ABS            | 881 704 | 912 532 |  |
| Accord 2.0               | (CA5)    | 88 → 88       | ABS            | 881 704 | -       |  |
| Accord 2.0               | (CA5)    | 89 → 89       | ABS            | 881 704 | 912 518 |  |
| Accord 2.0i 16V          | (CB3)    | 90 → 97       |                | 911 385 | 911 387 |  |
| Accord 2.0i 16V          | (CB3)    | 90 → 97       | 2WS            | 911 385 | 912 775 |  |
| Accord 2.0i 16V          | (CB3)    | 90 → 97       | 4WS            | 911 385 | 912 803 |  |
| Accord 2.0i 16V          | (CC7)    | 90 → 97       |                | 911 385 | 911 387 |  |
| Accord 2.0i 16V          | (CC7)    | 90 → 97       | ABS            | 911 385 | 912 775 |  |
| Accord 2.0i 16V V-Tec    | (CG)     | 10/98 → 01/01 | ABS            | 911 802 | 912 804 |  |
| Accord 2.0 TDi           | (CF1)    | 96 → 98       |                | 911 802 | 912 804 |  |
| Accord 2.0 Turbo DI      | (CG, CH) | 99 → 01/03    |                | 911 802 | 912 804 |  |
| Accord 2.0               | (CL7)    | 02/03 → 12/06 |                | 911 831 | -       |  |
| Accord 2.2i 16V          | (CB7)    | 90 → 97       |                | 911 385 | 911 387 |  |
| Accord 2.2i 16V          | (CB7)    | 90 → 97       | 2WS            | 911 385 | 912 775 |  |
| Accord 2.2i 16V          | (CB7)    | 90 → 97       | 4WS            | 911 385 | 912 803 |  |
| Accord 2.2i 16V          | (CD7)    | 94 → 97       |                | 911 385 | 912 292 |  |
| Accord 2.2i 16V Type-R   | (CG)     | 02/99 → 03    | ABS            | 911 802 | 912 804 |  |
| Accord 2.3i 16V          | (CG, CH) | 01 → 01/03    | ABS            | 911 802 | 912 804 |  |
| Accord 2.4               | (CL8)    | 02/03 → 12/06 |                | 911 831 | -       |  |
| Accord Aerodeck 2.0      | (CA5)    | 86 → 92       | <del>ABS</del> | 881 704 | 912 532 |  |
| Accord Aerodeck 2.0      | (CA5)    | 86 → 92       | ABS            | 881 704 | 912 518 |  |
| Accord Aerodeck 2.0i 16V | (CC9)    | 92 → 98       |                | 911 385 | -       |  |
| Accord Aerodeck 2.0i 16V | (CE2)    | 94 → 98       |                | 911 385 | 912 292 |  |
| Accord Aerodeck 2.2i 16V | (CB8)    | 90 → 98       |                | 911 385 | -       |  |
| Accord Aerodeck 2.2i 16V | (CE1)    | 94 → 98       |                | 911 385 | 912 292 |  |
| Accord Coupé 2.0i 16V    | (CB7)    | 90 → 97       |                | 911 385 | 911 387 |  |
| Accord Coupé 2.0i 16V    | (CC1)    | 92 → 97       |                | 911 385 | 912 775 |  |
| Accord Coupé 2.0i 16V    | (CG)     | 98 → 03       | ABS            | 911 802 | 912 804 |  |
| Accord Coupé 3.0i V6 24V | (CG)     | 98 → 03       |                | 911 802 | -       |  |
| Accord Tourer 2.0        | (CM1)    | 04/03 → 12/06 |                | 911 831 | -       |  |
| Accord Tourer 2.4        | (CM2)    | 04/03 → 12/06 |                | 911 831 | -       |  |
| Capa 1.5 16V             |          | 98 → 04       |                | 911 377 | -       |  |
| Civic                    |          | 80 → 83       |                | -       | 912 515 |  |
| Civic                    |          | 84 → 85       | Ch.→OS100000   | 911 600 | -       |  |
| Civic                    |          | 85 → 87       | Ch.OS100001→   | 911 600 | 912 530 |  |



| MODELL/MODEL/MODELE              |  | BEMERKUNGEN/REMARKS/<br>REMARQUES   |  |  |
|----------------------------------|---|---|---|---|
| Civic                            | 86 → 87   |    | 911 600   | -   |
| Civic 1.2 (EC7, ED1)             | 88 → 91   |   | 911 600   | 912 530   |
| Civic 1.3 16V (EC8)              | 88 → 91   |   | 911 600   | 912 530   |
| Civic 1.3 16V (EG3)              | 92 → 96   | {Rear  }   | 911 377   | 912 530   |
| Civic 1.3                        | 01/06 → 12/06   |   | 911 647   | -   |
| Civic 1.4 16V (EC9, ED2)         | 88 → 91   |   | 911 600   | 912 530   |
| Civic 1.4i 16V (EJ9)             | 96 → 01   | ABS {Rear  }   | 911 377   | 912 530   |
| Civic 1.4i 16V (EJ9)             | 96 → 02/01  | ABS {Rear  }   | 911 377   | 912 193   |
| Civic 1.4i 16V (MA8, MB2)        | 95 → 01   |    | 911 383   | 912 191   |
| Civic 1.4i 16V (MA8, MB2)        | 95 → 01   |    | 911 383   | 912 423   |
| Civic 1.4i 16V (MA8, MB2)        | 95 → 01   |    | 911 383   | 912 423   |
| Civic 1.4i 16V (EP1)             | 01 → 05   |    | 911 383   | 912 786   |
| Civic 1.4iS (EP1)                | 01 → 05   |    | 911 802   | 912 786   |
| Civic 1.4                        | 01/06 → 12/06   |   | 911 647   | -   |
| Civic 1.5i 16V (ED3)             | 88 → 91   |   | 911 600   | 912 530   |
| Civic 1.5i 16V (ED6)             | 88 → 91   | 3-Doors   | 911 600   | 912 530   |
| Civic 1.5i 16V (EG4, EG8)        | 92 → 95   | {Rear  }   | 911 377   | 912 530   |
| Civic 1.5i 16V (EH2)             | 92 → 92   | 4-Doors   | 911 377   | 912 530   |
| Civic 1.5i 16V (MA9, MB3)        | 95 → 01/97  |    | 911 383   | 912 191   |
| Civic 1.5i 16V (MA9, MB3)        | 95 → 01/97  |    | 911 383   | 912 423   |
| Civic 1.5i 16V V-Tec (EK3)       | 96 → 01   | ABS {Rear  }   | 911 383   | 912 530   |
| Civic 1.5i 16V V-Tec (EK3)       | 96 → 01   | ABS {Rear  }   | 911 383   | 912 191   |
| Civic 1.5i 16V V-Tec (EK3)       | 96 → 01   | ABS {Rear  }  | 911 383   | 912 193   |
| Civic 1.5i 16V V-Tec (EK3)       | 96 → 01   | ABS {Rear  }   | 911 383   | 912 423   |
| Civic 1.5i 16V (EU1/2)           | 01 → 05   |   | 911 383   | -   |
| Civic 1.6i 16V (ED7)             | 88 → 91   | 3-Doors   | 911 600   | 912 530   |
| Civic 1.6i 16V (ED4)             | 88 → 91   |   | 911 600   | 912 530   |
| Civic 1.6i 16V 4WD (EE5)         | 88 → 91   |   | 911 600   | 912 530   |
| Civic 1.6i 16V (EG2, EG9)        | 92 → 96   | ABS {Rear  }   | 911 383   | 912 423   |
| Civic 1.6i 16V (EH1)             | 92 → 95   |   | 911 383   | -   |
| Civic 1.6i 16V (EH3)             | 92 → 92   | 4-Doors   | 911 377   | 912 530   |
| Civic 1.6i 16V (EH6)             | 92 → 96   |    | 911 383   | 912 530   |
| Civic 1.6i 16V (EH6)             | 92 → 96   |  ABS   | 911 383   | 912 423   |
| Civic 1.6i 16V (EH9)             | 94 → 95   | ABS {Rear  }   | 911 377   | 912 530   |
| Civic 1.6i 16V (EH9)             | 92 → 95   | ABS {Rear  }   | 911 377   | 912 191   |
| Civic 1.6i 16V (EH9)             | 94 → 95   | ABS {Rear  }   | 911 383   | 912 530   |
| Civic 1.6i 16V (EH9)             | 94 → 95   | ABS {Rear  }   | 911 383   | 912 423   |
| Civic 1.6i 16V (EK1)             | 96 → 02/01  | ABS {Rear  }   | 911 383   | 912 530   |
| Civic 1.6i 16V (EK1)             | 96 → 02/01  | ABS {Rear  }   | 911 383   | 912 423   |
| Civic 1.6i 16V (EK1)             | 96 → 02/01  | ABS {Rear  }   | 911 383   | 912 191   |
| Civic 1.6i 16V (EK1)             | 96 → 02/01  | ABS {Rear  }   | 911 383   | 912 193   |
| Civic 1.6i 16V (MB1, MB4)        | 95 → 02/98  | ABS {Rear  }   | 911 383   | 912 423   |
| Civic 1.6i 16V V-Tec (EG5)       | 92 → 95   | ABS {Rear  }   | 911 377   | 912 191   |
| Civic 1.6i 16V V-Tec (EG5)       | 94 → 95   | ABS {Rear  }   | 911 383   | 912 423   |
| Civic 1.6i 16V V-Tec (EG6)       | 92 → 95   | ABS   | 911 383   | 912 423   |
| Civic 1.6i 16V V-Tec (EK4)       | 96 → 02/01  | ABS {Rear  }   | 911 383   | 912 423   |
| Civic 1.6i 16V (EU_, EP_)        | 01 → 05   |    | 911 383   | 912 786   |
| Civic 1.7i 16V (EU_, EP_)        | 01 → 05   |   15" | 911 383   | 912 786   |
| Civic 1.7 CTDi (EU_, EP_)        | 02 → 05   |    | 911 383   | 912 786   |
| Civic 1.8i 16V (MB6)             | 97 → 02/01  |   | 911 383   | 912 295   |
| Civic 1.8                        | 01/06 → 12/06   |   | 911 647   | -   |
| Civic 2.0i 16V Type-R (EU_, EP_) | 01 → 05   |   | 911 802   | -   |
| Civic 2.0i 16V Sport (EU_, EP_)  | 04 → 05   |   | 911 802   | -   |
| Civic 2.0i Turbo Diesel (MB7)    | 97 → 00   |    | 911 383   | 912 191   |

| MODELL/MODEL/MODELE            |              | BEMERKUNGEN/REMARKS/<br>REMARQUES |                             |  |         |
|--------------------------------|--------------|-----------------------------------|-----------------------------|---|---------|
| Civic 2.0i Turbo Diesel        | (MB7)        | 97 → 00                           | ☉                           | 911 383   | -       |
| Civic 2.2 CTDi                 |              | 01/06 → 12/06                     |                             | 911 647   | -       |
| Civic Coupé 1.5i 16V DX        | (EJ2)        | 93 → 93                           | ABS 2-Doors                 | 911 377   | 912 530 |
| Civic Coupé 1.5i 16V EX        | (EJ2)        | 94 → 94                           | ABS 2-Doors                 | 911 383   | 912 423 |
| Civic Coupé 1.5i 16V EX & EX-S | (EJ2)        | 93 → 94                           | ABS 2-Doors                 | 911 383   | 912 530 |
| Civic Coupé 1.6i 16V DX        | (EJ1)        | 93 → 93                           | ABS 2-Doors                 | 911 377   | 912 530 |
| Civic Coupé 1.6i 16V EX & EX-S | (EJ1)        | 93 → 93                           | ABS 2-Doors                 | 911 383   | 912 530 |
| Civic Coupé 1.7i 16V V-Tec     | (EM_)        | 01 → 05                           |                             | 911 383   | -       |
| Civic Coupé 1.7i 16V           | (EM_)        | 01 → 05                           |                             | 911 383   | -       |
| Civic del sol 1.5i 16V         | (EG1)        | 93 → 95                           |                             | 911 377   | 912 530 |
| Civic del sol 1.6i 16V         | (EG2)        | 94 → 95                           | ABS                         | 911 383   | 912 191 |
| Civic del sol 1.6i 16V         | (EG2)        | 95 → 95                           | ABS                         | 911 383   | 912 423 |
| Civic del sol 1.6i 16V         | (EH6)        | 93 → 95                           | ABS ☉                       | 911 377   | 912 191 |
| Civic del sol 1.6i 16V         | (EH6)        | 95 → 95                           | ABS ☉                       | 911 383   | 912 423 |
| Civic Shuttle                  |              | 84 → 84                           | Ch.→OS100000                | 911 600   | -       |
| Civic Shuttle                  |              | 85 → 87                           | Ch.OS100001→                | 911 600   | 912 530 |
| Civic Shuttle                  |              | 88 → 88                           |                             | 911 600   | 912 532 |
| Civic Shuttle 1.4              | (EE1)        | 88 → 91                           |                             | 911 600   | 912 532 |
| Civic Shuttle 1.5              | (EE2)        | 88 → 91                           |                             | 911 600   | 912 532 |
| Civic Shuttle 1.6              | (EE4)        | 88 → 91                           |                             | 911 600   | -       |
| Civic Shuttle 4WD              |              | 85 → 90                           |                             | 911 600   | -       |
| Concerto 1.5i 16V              | (HW)         | 89 → 95                           | ABS                         | 881 704   | 912 532 |
| Concerto 1.5i 16V              | (HW)         | 89 → 95                           | ABS                         | 881 704   | 912 518 |
| Concerto 1.6i 16V              | (HW)         | 89 → 95                           | ABS                         | 881 704   | 912 532 |
| Concerto 1.6i 16V              | (HW)         | 89 → 95                           | ABS                         | 881 704   | 912 518 |
| CR-V 2.0i 16V 2WD              | (RD2)        | 05/00 → 02/01                     |                             | 911 802   | 912 527 |
| CR-V 2.0i 16V 4WD              | (RD1, RD3)   | 10/95 → 02/01                     |                             | 911 802   | 912 527 |
| CR-V II 2.0i 16V 4WD           |              | 07/02 → 04                        | ABS - Active Sensor Bearing | 911 647   | 912 527 |
| CR-X 1.5                       | (EF6)        | 90 → 02/92                        |                             | 911 600   | -       |
| CR-X 1.5                       | (EG1)        | 02/92 → 94                        |                             | 911 383   | -       |
| CR-X 1.6                       | (ED8, ED9)   | 88 → 90                           | ☉                           | -   | 912 530 |
| CR-X 1.6                       | (EF7)        | 90 → 02/92                        |                             | 911 600   | -       |
| CR-X 1.6                       | (EF8)        | 90 → 02/92                        |                             | 911 777   | -       |
| CR-X 1.6                       | (EG2)        | 02/92 → 96                        | ABS {Rear ☉ }               | 911 383   | 912 191 |
| CR-X 1.6                       | (EG2)        | 02/92 → 96                        | ABS {Rear ☉ }               | 911 383   | 912 423 |
| CR-X 1.6                       | (EH6)        | 02/92 → 96                        | {Rear ☉ }                   | 911 383   | 912 530 |
| CR-X 1.6                       | (EH6)        | 95 → 96                           | {Rear ☉ }                   | 911 383   | 912 423 |
| CR-X 1.6                       | (EJ4)        | 09/95 → 02/01                     |                             | 911 377   | -       |
| FR-V 1.7, 2.0                  |              | 02/05 → 12/06                     |                             | 911 647   | -       |
| HR-V 1.6 16V                   | (GH1/2/3/4)  | 99 → 02                           |                             | 911 383   | 912 809 |
| HR-V 1.6 16V 4WD               | (GH1/2/3/4)  | 99 → 02                           |                             | 911 383   | 912 809 |
| Integra 1.5                    | (DA2/4)      | 86 → 88                           |                             | 911 600   | 912 530 |
| Integra 1.6                    | (DA5, DA7)   | 04/89 → 05/93                     | ABS                         | 911 383   | 912 530 |
| Integra 1.6                    | (DA5, DA7)   | 04/89 → 05/93                     | ABS                         | 911 777   | -       |
| Integra 1.6                    | (DA6, DA8)   | 04/89 → 05/93                     |                             | 911 777   | -       |
| Integra 1.6                    | (DB6/9, DC1) | 07/93 → 00                        |                             | 911 383   | -       |
| Integra 1.8                    | (DB1)        | 10/91 → 07/93                     |                             | 911 777   | -       |
| Integra 1.8                    | (DB7/8, DC2) | 07/93 → 04/94                     |                             | 911 383   | -       |
| Integra 1.8 Type R             | (DB8R, DC2R) | 10/95 → 00                        |                             | 911 383   | 912 294 |
| Jazz                           | (AA)         | 82 → 86                           |                             | -   | 912 515 |
| Jazz 1.2                       | (GD)         | 02 → 04                           |                             | 911 377   | -       |
| Jazz 1.4                       | (GD)         | 02 → 04                           |                             | 911 377   | -       |
| Jazz 2.6                       | (CG5, CY5)   | 11/93 → 94                        |                             | 201 262   | -       |
| Jazz 3.2                       | (CG5, CY5)   | 11/93 → 94                        |                             | 201 262   | -       |

| MODELL/MODEL/MODELE    |             |  | BEMERKUNGEN/REMARKS/<br>REMARQUES  |  |  |  |
|------------------------|-------------|---|--|--|---|---|
| Legend 2.5i 24V        | (HS)        | 11/86 → 90  |  |  | 881 609   | -   |
| Legend 2.7i 24V        | (HS, KA3/4) | 11/87 → 90  |  |  | 911 399   | -   |
| Legend 3.2i 24V DOHC   | (KA7/8)     | 10/90 → 98  |  |  | 911 969   | 912 992   |
| Legend 3.5i 24V DOHC   | (KA9)       | 04/96 → 00  |  |  | 911 969   | 912 992   |
| Logo 1.3               | (GA3)       | 99 → 03   |  |  | 911 377   | 912 530   |
| Odyssey 2.2i 16V       | (RA1/2)     | 09/94 → 00  |  |  | 911 968   | -   |
| Odyssey 2.3i 16V       | (RA3/4)     | 09/97 → 00  |  |  | 911 968   | -   |
| Odyssey 3.0i 24V       | (RA5)       | 09/97 → 00  |  |  | 911 968   | -   |
| Passport 2.6           | (CG5, CY5)  | 11/93 → 94  |  |  | 201 262   | -   |
| Passport 3.2           | (CG5, CY5)  | 11/93 → 94  |  |  | 201 262   | -   |
| Prelude 1.6            | (SN)        | 79 → 80   |  |  | -   | 912 515   |
| Prelude 1.6            | (SN)        | 81 → 82   |  |  | -   | 912 515   |
| Prelude 1.8 EX         | (AB)        | 83 → 04/87  | Ch.→OC300000   |  | -   | 912 473   |
| Prelude 1.8 EX         | (AB)        | 86 → 04/87  | Mot.FI   |  | 881 704   | 912 473   |
| Prelude 2.0i 16V 4WS   | (BA4)       | 88 → 92   |  |  | 911 777   | 912 545   |
| Prelude 2.0i 16V       | (BB3)       | 92 → 09/96  | <del>ABS</del>   |  | 911 399   | 912 403   |
| Prelude 2.0i 16V       | (BB3)       | 92 → 09/96  | ABS  |  | 911 399   | 912 401   |
| Prelude 2.0i 16V       | (BB9)       | 10/96 → 00  |  x4   |  | 911 802   | 912 295   |
| Prelude 2.0i 16V       | (BB9)       | 10/96 → 00  |  x5   |  | 911 802   | 912 296   |
| Prelude 2.2i 16V V-Tec | (BB1)       | 92 → 09/96  | <del>ABS</del>   |  | 911 399   | 912 403   |
| Prelude 2.2i 16V V-Tec | (BB1)       | 92 → 09/96  | ABS  |  | 911 399   | 912 401   |
| Prelude 2.2i 16V       | (BB6)       | 10/96 → 00  |  x4   |  | 911 802   | 912 295   |
| Prelude 2.2i 16V       | (BB6)       | 10/96 → 00  |  x5 |  | 911 802   | 912 296   |
| Prelude 2.2i 16V       | (BB8)       | 10/96 → 00  |  x5 |  | 911 383   | 912 296   |
| Prelude 2.3i 16V       | (BB2)       | 92 → 09/96  | <del>ABS</del>   |  | 911 399   | 912 403   |
| Prelude 2.3i 16V       | (BB2)       | 92 → 09/96  | ABS  |  | 911 399   | 912 401   |
| Quintet 1.6 EX         | (SU)        | 80 → 83   |  |  | -   | 912 515   |
| Shuttle 2.2i 16V       | (RA18)      | 06/95 → 00  |  |  | 911 968   | 912 991   |
| Shuttle 2.3i 16V       | (RA38)      | 11/97 → 00  |  |  | 911 968   | 912 991   |

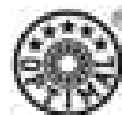

















## BEMERKUNGEN/REMARKS/ REMARQUES























































## MODELL/MODEL/MODELE





| MODELL/MODEL/MODELE       |              | BEMERKUNGEN/REMARKS/<br>REMARQUES        |         |         |
|---------------------------|--------------|--|---------|---------|
| Accent 1.3i               |              | 09/94 → 08/99 Mot.G4EH <del>ABS</del>    | 951 606 | 922 781 |
| Accent 1.3i               |              | 09/94 → 08/99 Mot.G4EH ABS               | 951 606 | 922 783 |
| Accent 1.3i               |              | 00 → 05 Mot.G4EA <del>ABS</del>          | 951 962 | 922 697 |
| Accent 1.3i               |              | 00 → 05 Mot.G4EA ABS                     | 951 962 | 922 189 |
| Accent 1.5i               |              | 07/94 → 99 Mot.G4EK <del>ABS</del>       | 951 606 | 922 781 |
| Accent 1.5i               |              | 07/94 → 99 Mot.G4EK ABS                  | 951 606 | 922 783 |
| Accent 1.5i 16V GT        |              | 10/95 → 99 Mot.G4EK                      | 951 606 | 922 783 |
| Accent 1.5i               |              | 00 → 05 Mot.G4EB-C <del>ABS</del>        | 951 962 | 922 697 |
| Accent 1.5i               |              | 00 → 05 Mot.G4EB-C ABS                   | 951 962 | 922 189 |
| Accent 1.5 CRDi           |              | 01 → 05 Mot.G3EA <del>ABS</del>          | 951 962 | 922 697 |
| Accent 1.5 CRDi           |              | 01 → 05 Mot.G3EA ABS                     | 951 962 | 922 189 |
| Accent 1.6                |              | 02 → 05 Mot.G4ED-G <del>ABS</del>        | 951 962 | 922 697 |
| Accent 1.6                |              | 02 → 05 Mot.G4ED-G ABS                   | 951 962 | 922 189 |
| Atos 1.0i                 |              | 97 → 02/01                               | 951 606 | 922 187 |
| Atos 1.0i                 |              | 03/01 → 04                               | 951 606 | 922 187 |
| Atos Prime 1.0i           |              | 99 → 04                                  | 951 606 | 922 187 |
| Atos Prime 1.1i           |              | 06/03 → 04                               | 951 606 | 922 187 |
| Avante                    |              | 96 → 99 <del>ABS</del>                   | 951 962 | 922 921 |
| Avante                    |              | 96 → 99 ABS                              | 951 962 | 922 979 |
| Coupe 1.6 16V             | (RD)         | 96 → 04/02 <del>ABS</del>                | 951 962 | 922 921 |
| Coupe 1.6 16V             | (RD)         | 96 → 04/02 ABS                           | 951 962 | 922 979 |
| Coupe 2.0 16V             | (RD)         | 96 → 04/02 <del>ABS</del>                | 951 962 | 922 921 |
| Coupe 2.0 16V             | (RD)         | 96 → 04/02 ABS                           | 951 962 | 922 921 |
| Coupe 2.0 16V             | (GK)         | 03/02 → 04                               | 921 906 | -       |
| Coupe 2.7 V6 24V          | (GK)         | 03/02 → 04                               | 921 215 | -       |
| Elantra                   |              | 90 → 99                                  | 951 606 | 922 441 |
| Elantra                   |              | 00 → 05                                  | 921 215 | 922 871 |
| Excel 1.3                 |              | 10/94 → 95 Mot.G4EH <del>ABS</del>       | 951 606 | 922 781 |
| Excel 1.3                 |              | 10/94 → 95 Mot.G4EH ABS                  | 951 606 | 922 783 |
| Excel 1.5                 |              | 12/85 → 04/89 Mot.G4DJ ABS               | 951 606 | 922 783 |
| Excel 1.5                 |              | 05/89 → 08/93 Mot.G4DJ                   | 951 606 | 922 441 |
| Excel 1.5                 |              | 10/94 → 95 Mot.G4EK, G4FK <del>ABS</del> | 951 606 | 922 781 |
| Excel 1.5                 |              | 10/94 → 95 Mot.G4EK, G4FK ABS            | 951 606 | 922 783 |
| Excel 1.6                 |              | 04/91 → 08/93                            | 951 606 | 922 441 |
| Excel 1.8                 |              | 04/91 → 08/93                            | 951 606 | 922 441 |
| Galopper 2.5 Turbo Diesel |              | 91 → 02                                  | 951 722 | -       |
| Galopper 3.0 V6 12V       |              | 91 → 02                                  | 951 722 | -       |
| Getz                      |              | 09/02 → 04                               | 951 962 | -       |
| Lantra I                  |              | 90 → 95                                  | 951 606 | 922 441 |
| Lantra II 1.5 12V         |              | 05/95 → 03                               | 951 962 | 922 979 |
| Lantra II 1.6 16V         |              | 05/95 → 03                               | 951 962 | 922 979 |
| Lantra II 1.8 16V         |              | 05/95 → 03                               | 951 962 | 922 979 |
| Lantra II 1.8 16V GT      |              | 05/95 → 03                               | 951 962 | 922 979 |
| Lantra II 1.9 D           |              | 98 → 03                                  | 951 962 | 922 979 |
| Lantra II 2.0 16V         |              | 05/95 → 03                               | 951 962 | 922 979 |
| Matrix                    |              | 06/01 → 04                               | 921 906 | 922 871 |
| Pony I                    |              | 82 → 90                                  | 920 752 | 922 439 |
| Pony II 1.3               | (VD)         | 07/91 → 95 Mot.G4DG                      | 951 606 | 922 441 |
| Pony II 1.5               | (VD, VF, VA) | 07/91 → 95 Mot.G4DJ                      | 951 606 | 922 441 |
| S Coupé 1.5i              |              | 90 → 96 Mot.G4DJ, G4EK                   | 951 606 | 922 882 |
| Santa Fé 2.0i 16V         |              | 00 → 04                                  | 921 895 | 922 875 |
| Santa Fé 2.0 CRDi         |              | 00 → 04                                  | 921 895 | 922 875 |
| Santa Fé 2.0 CRDi 4x4     |              | 00 → 04                                  | 921 895 | 922 877 |
| Santa Fé 2.4i 16V         |              | 00 → 04                                  | 921 895 | 922 875 |

| MODELL/MODEL/MODELE         |  | BEMERKUNGEN/REMARKS/<br>REMARQUES  |  |  |
|-----------------------------|---|--|---|---|
| Santa Fé 2.4i 16V 4x4       | 00 → 04   |  | 921 895   | 922 877   |
| Santa Fé 2.7 V6 24V 4x4     | 00 → 04   |  | 921 895   | 922 877   |
| Sonata I 1.8i (BF2/3)       | 10/88 → 93  |  | 951 449   | 922 395   |
| Sonata I 2.0i 16V (BF2/3)   | 10/88 → 93  |  | 951 449   | 922 395   |
| Sonata I 2.4i (BF2/3)       | 10/88 → 92  |  | 951 449   | 922 395   |
| Sonata I 3.0i (BF3)         | 91 → 93   |  | 951 449   | 922 395   |
| Sonata II 1.8i (CF2)        | 05/93 → 06/98   | ABS  | 951 282   | 922 217   |
| Sonata II 1.8i (CF2)        | 05/93 → 06/98   | ABS  | 951 282   | 922 219   |
| Sonata II 2.0i 16V (CF2/3)  | 05/93 → 06/98   | ABS  | 951 282   | 922 217   |
| Sonata II 2.0i 16V (CF2/3)  | 05/93 → 06/98   | ABS  | 951 282   | 922 219   |
| Sonata II 3.0i (CF3)        | 05/93 → 06/98   | ABS  | 951 282   | 922 217   |
| Sonata II 3.0i (CF3)        | 05/93 → 06/98   | ABS  | 951 282   | 922 219   |
| Sonata III 2.0i 16V (EF)    | 06/98 → 04  | ABS  | 921 215   | 922 221   |
| Sonata III 2.0i 16V (EF)    | 06/98 → 04  | ABS  | 921 215   | 922 223   |
| Sonata III 2.4i 16V (EF)    | 03/98 → 04  | ABS  | 921 215   | 922 221   |
| Sonata III 2.4i 16V (EF)    | 03/98 → 04  | ABS  | 921 215   | 922 223   |
| Sonata III 2.5i V6 24V (EF) | 06/98 → 04  | ABS  | 921 215   | 922 221   |
| Sonata III 2.5i V6 24V (EF) | 06/98 → 04  | ABS  | 921 215   | 922 223   |
| Sonata IV 2.7 V6 24V        | 10/01 → 04  | ABS  | -   | 922 223   |
| Sonata IV 2.7 V6 24V        | 10/01 → 04  | ABS  | -   | 922 221   |
| Starex 2.4                  | 97 → 04   |  | 951 708   | -   |
| Starex 2.5 TD               | 97 → 04   |  | 951 708   | -   |
| Stellar 1.6 (KSC)           | 12/86 → 87  |  | 920 752   | -   |
| Stellar 1.6 (MIP)           | 01/87 → 92  |  | 920 752   | -   |
| Stellar 1.8 (MPI, FBM)      | 88 → 92   |  | 920 752   | 922 439   |
| Stellar 2.0 (MPI, FBM)      | 88 → 92   |  | 920 752   | 922 439   |
| XG                          | 98 → 04   |  | 921 215   | -   |
| H1 2.4i                     | 10/97 → 04  |           | 951 708   | 922 854   |
| H1 2.4i 4WD                 | 10/97 → 04  |           | -   | 922 854   |
| H1 2.5 D, 2.5 TD            | 10/97 → 04  |           | 951 708   | 922 854   |
| H100 2.4i                   | 07/93 → 00  |           | 951 708   | 922 854   |
| H100 2.5 D, 2.5 TD          | 07/93 → 00  |           | 951 708   | 922 854   |
| H150 2.5 Diesel             | 07/97 → 00  |           | 951 708   | 922 854   |
| Pony Pickup 1.2             | 82 → 92   |           | 920 752   | 922 439   |
| Pony Pickup 1.5             | 86 → 88   |  Mot.G4AJ | 951 606   | 920 752   |
| Trajjet 2.0i 16V            | 00 → 03   |           | 921 895   | 922 875   |
| Trajjet 2.0 CRDi            | 01 → 03   |           | 921 895   | 922 875   |
| Trajjet 2.7 V6 24V          | 00 → 03   |           | 921 895   | -   |
| Tucson 2.0                  | 08/04 → 05  |           | 921 895   | -   |
| Tucson 2.0 4WD              | 08/04 → 05  |           | 921 895   | -   |
| Tucson 2.7                  | 08/04 → 05  |           | 921 895   | -   |





| MODELL/MODEL/MODELE     |         | BEMERKUNGEN/REMARKS/<br>REMARQUES |   |   |         |
|-------------------------|---------|-----------------------------------|---|---|---------|
| Elf 150 2800 Diesel     | (NHR55) | 85 → 93                           |   | 931 930   | 932 933 |
| Elf 250 2800 Diesel     | (NHR55) | 85 → 93                           |  | 931 932   | 932 665 |
| Elf 250 2800 Diesel     | (NHR55) | 85 → 93                           |  | 931 649   | 932 665 |
| Elf 250 3600 Diesel     | (NKR58) | 85 → 93                           |  | 931 932   | 932 665 |
| Elf 250 3600 Diesel     | (NKR58) | 85 → 93                           |  | 931 649   | 932 665 |
| KB 4x2                  |         | 76 → 86                           |   | -   | 932 794 |
| KB 4x4                  |         | 76 → 81                           |   | -   | 932 794 |
| KB 4x4                  |         | 82 → 86                           |   | -   | 932 794 |
| NPR 57, NKR             |         | 84 → 85                           |   | 931 649   | 932 665 |
| NPR 59                  |         | 84 → 85                           |   | 931 649   | -       |
| Panther 2.2 Diesel      | (TBR)   | 09/90 → 01/96                     |   | 931 931   | 932 934 |
| Panther 2.5 Diesel      | (TBR)   | 02/96 → 04                        |   | 931 931   | 932 934 |
| Trooper I               | (UBS)   | 83 → 85                           |   | -   | 932 794 |
| Trooper I 2.2 D         | (UBS)   | 01/86 → 88                        |   | 201 262   | 932 794 |
| Trooper I 2.3           | (UBS)   | 01/86 → 88                        |   | 201 262   | 932 794 |
| Trooper I 2.6i          | (UBS)   | 88 → 91                           |   | 201 262   | 932 864 |
| Trooper I 2.8 TD        | (UBS)   | 88 → 91                           |   | 201 262   | 932 864 |
| Trooper II 3.1 D        | (UB)    | 91 → 98                           |   | 201 262   | 932 864 |
| Trooper II 3.2          | (UB)    | 91 → 98                           |   | 201 262   | 932 864 |
| Trooper III 3.0 DTI     |         | 00 → 02                           |   | 201 262   | 932 864 |
| Trooper III 3.5i V6 24V |         | 00 → 02                           |   | 201 262   | 932 864 |
| WFR 4x2                 |         | 83 → 87                           |   | -   | 932 794 |
| WFS 4x4                 |         | 86 → 87                           |   | -   | 932 794 |



| MODELL/MODEL/MODELE       |  | BEMERKUNGEN/REMARKS/<br>REMARQUES   |  |  |
|---------------------------|---|---|---|---|
| 238                       | 72 → 82   |                                        | 801 746   | 802 662   |
| 238                       | 72 → 82   |                                        | 801 746   | 802 660   |
| 242                       | 74 → 82   |   | 681 640   | 682 642   |
| Daily I 30-8              | 10/84 → 01/97   |  Iveco                                 | 801 644   | 802 748   |
| Daily I 30-8              | 10/84 → 01/97   |  Iveco                                 | 801 750   | 802 748   |
| Daily I 30-9              | 10/84 → 88  |  Iveco                                 | 801 644   | 802 748   |
| Daily I 30-9              | 10/84 → 88  |  Iveco                                 | 801 750   | 802 748   |
| Daily I 35-8              | 10/84 → 02/96   | <del>5.22/1</del> transmission  Iveco | 801 644   | 802 748   |
| Daily I 35-8              | 10/84 → 02/96   | <del>5.22/1</del> transmission  Iveco | 801 750   | 802 748   |
| Daily I 35-8              | 10/84 → 02/96   | 5.22/1 transmission  Iveco            | 801 644   | 802 740   |
| Daily I 35-8              | 10/84 → 02/96   | 5.22/1 transmission  Iveco            | 801 750   | 802 740   |
| Daily I 35-8              | 03/96 → 99  | Single row taper roller bearing      | 801 644   | 802 748   |
| Daily I 35-8              | 03/96 → 99  | Single row taper roller bearing      | 801 750   | 802 748   |
| Daily I 35-8              | 03/96 → 99  | Double row taper roller bearing   | 681 923   | 682 925   |
| Daily I 35-9              | 06/81 → 09/84   |  Iveco                                 | 801 644   | 802 748   |
| Daily I 35-9              | 06/81 → 09/84   |  Iveco                                 | 801 750   | 802 748   |
| Daily I 35-10             | 06/81 → 05/89   |                                        | 801 644   | 802 748   |
| Daily I 35-10             | 06/81 → 05/89   |                                        | 801 750   | 802 748   |
| Daily I 35-10             | 06/89 → 01/97   | "Iveco check control"                 | 801 644   | 802 748   |
| Daily I 35-10             | 06/89 → 01/97   | "Iveco check control"                 | 801 750   | 802 748   |
| Daily I 35-10             | 06/89 → 01/97   | "Iveco check control"                 | 801 644   | 802 740   |
| Daily I 35-10             | 06/89 → 01/97   | "Iveco check control"                 | 801 750   | 802 740   |
| Daily I 35-10 Turbodayly  | 96 → 99   | Single row taper roller bearing   | 681 923   | 802 748   |
| Daily I 35-10 Turbodayly  | 96 → 99   | Double row taper roller bearing   | 681 923   | 682 925   |
| Daily I 35-12 Turbodayly  | 81 → 02/96  |                                      | 681 910   | 802 748   |
| Daily I 35-12 Turbodayly  | 81 → 02/96  |                                      | 681 909   | 802 748   |
| Daily I 35-12 Turbodayly  | 03/96 → 99  | Single row taper roller bearing   | 681 923   | 802 748   |
| Daily I 35-12 Turbodayly  | 03/96 → 99  | Double row taper roller bearing   | 681 923   | 682 925   |
| Daily I 40-8              | 10/84 → 02/96   |  Iveco                               | 801 644   | 802 748   |
| Daily I 40-8              | 10/84 → 02/96   |  Iveco                               | 801 750   | 802 748   |
| Daily I 45-10             | 85 → 88   | <del>5.62/1</del> transmission      | 681 910   | 802 740   |
| Daily I 45-10             | 85 → 88   | <del>5.62/1</del> transmission      | 681 909   | 802 740   |
| Daily I 45-10             | 85 → 88   | 5.62/1 transmission                 | 681 910   | 802 748   |
| Daily I 45-10             | 85 → 88   | 5.62/1 transmission                 | 681 909   | 802 748   |
| Daily I 49-10             | 85 → 88   | ABS                                  | 681 910   | 802 740   |
| Daily I 49-10             | 85 → 88   | ABS                                  | 681 909   | 802 740   |
| Daily I 49-10             | 85 → 88   | ABS                                  | 681 910   | 802 748   |
| Daily I 49-10             | 85 → 88   | ABS                                  | 681 909   | 802 748   |
| Daily I 49-10 Turbodayly  | 96 → 99   |   | 681 923   | 682 925   |
| Daily I 49-12 Turbodayly  | 85 → 02/96  |                                      | 681 910   | 802 740   |
| Daily I 49-12 Turbodayly  | 85 → 02/96  |                                      | 681 909   | 802 740   |
| Daily I 49-12 Turbodayly  | 03/96 → 99  |   | 681 923   | 682 925   |
| Daily I 59-12 Turbodayly  | 91 → 99   |   | 681 924   | -   |
| Daily II                  | 05/99 → 05  |   | 681 923   | 682 925   |
| Grinta                    | 06/81 → 09/84   |  Iveco                               | 801 644   | 802 748   |
| Grinta                    | 06/81 → 09/84   |  Iveco                               | 801 750   | 802 748   |
| Grinta Ser S: 30-9        | 10/84 → 88  |  Iveco                               | 801 644   | 802 748   |
| Grinta Ser S: 30-9        | 10/84 → 88  |  Iveco                               | 801 750   | 802 748   |
| Grinta Ser S: 35-8, 35-10 | 10/84 → 88  |  Iveco                               | 801 644   | 802 748   |
| Grinta Ser S: 35-8, 35-10 | 10/84 → 88  |  Iveco                               | 801 750   | 802 748   |
| Grinta Ser S: 40-8, 40-10 | 10/84 → 88  |  Iveco                               | 801 644   | 802 748   |
| Grinta Ser S: 40-8, 40-10 | 10/84 → 88  |  Iveco                               | 801 750   | 802 748   |
| Grinta Ser S Turbo: 45-10 | 03/85 → 88  |  Iveco 4512                          | 681 910   | 802 740   |
| Grinta Ser S Turbo: 45-10 | 03/85 → 88  |  Iveco 4512                          | 681 909   | 802 740   |





| MODELL/MODEL/MODELE       |  | BEMERKUNGEN/REMARKS/<br>REMARQUES  |  |
|---------------------------|---|--|---|
| Grinta Ser S Turbo: 49-10 | 03/85 → 88  |  Iveco 4512 | <b>681 910</b> <b>802 740</b>   |
| Grinta Ser S Turbo: 49-10 | 03/85 → 88  |  Iveco 4512 | <b>681 909</b> <b>802 740</b>   |



| MODELL/MODEL/MODELE |  | BEMERKUNGEN/REMARKS/<br>REMARQUES |  |  |
|---------------------|---|-----------------------------------|---|---|
| XJ 6 2.9            | 87 → 90   |                                   | 881 489   | 882 491   |
| XJ 6 3.2 24V        | 91 → 96   |                                   | 881 489   | 882 491   |
| XJ 6 3.4            | 77 → 86   |                                   | 881 564   | 882 666   |
| XJ 6 3.6            | 87 → 89   |                                   | 881 489   | 882 491   |
| XJ 6 4.0 24V        | 90 → 96   |                                   | 881 489   | 882 491   |
| XJ 6 4.2            | 77 → 86   |                                   | 881 564   | 882 666   |
| XJ 12 5.3           | 77 → 86   |                                   | 881 564   | 882 666   |
| XJ 12 5.3           | 87 → 92   |                                   | 881 489   | 882 491   |
| XJ 12 6.0           | 93 → 96   |                                   | 881 489   | 882 491   |
| XJ-S 3.6            | 84 → 88   | Ch.→147268                        | 881 564   | 882 666   |
| XJ-S 3.6            | 88 → 91   | Ch.147269→                        | 880 493   | 882 666   |
| XJ-S 4.0 24V        | 91 → 92   | Ch.→188104                        | 880 493   | 882 666   |
| XJ-S 4.0 24V        | 92 → 96   | Ch.188105→                        | 880 493   | 880 493   |
| XJ-S 5.3            | 77 → 88   | Ch.→147268                        | 881 564   | 882 666   |
| XJ-S 5.3            | 88 → 92   | Ch.147269→                        | 880 493   | 882 666   |
| XJR-S 6.0           | 92 → 96   |                                   | 880 493   | 880 493   |
| X-Type 2.0 V6 24V   | 03/02 → 05  |                                   | 301 183   | 302 197   |
| X-Type 2.0 Diesel   | 07/03 → 10/05   |                                   | 301 183   | 302 197   |
| X-Type 2.2 Diesel   | 10/05 → 12/05   |                                   | 301 183   | 302 197   |
| X-Type 2.5 V6 24V   | 4x4 06/01 → 05  |                                   | 301 183   | -   |
| X-Type 3.0 V6 24V   | 4x4 06/01 → 05  |                                   | 301 183   | -   |



| MODELL/MODEL/MODELE   |  | BEMERKUNGEN/REMARKS/<br>REMARQUES |  |  |
|-----------------------|---|-----------------------------------|---|---|
| Avella                | 94 → 98   |                                   | 941 636   | 942 768   |
| Besta 2.2 D           | 96 → 00   |                                   | 941 281   | -   |
| Capital               | 90 → 06/93  |                                   | 942 738   | 942 768   |
| Capital               | 07/93 → 94  |                                   | 921 553   | 942 768   |
| Carens I 1.8i 16V     | 00 → 07/02  | <del>ABS</del>                    | 940 371   | 922 179   |
| Carens I 1.8i 16V     | 00 → 07/02  | ABS                               | 940 371   | 922 181   |
| Carens II 1.6i 16V    | 07/02 → 05  | <del>ABS</del>                    | 940 371   | 922 179   |
| Carens II 1.6i 16V    | 07/02 → 05  | ABS                               | 940 371   | 922 181   |
| Carens II 1.8i 16V    | 07/02 → 05  | <del>ABS</del>                    | 940 371   | 922 179   |
| Carens II 1.8i 16V    | 07/02 → 05  | ABS                               | 940 371   | 922 181   |
| Carens II 2.0 CRDi    | 07/02 → 05  | <del>ABS</del>                    | 940 371   | 922 179   |
| Carens II 2.0 CRDi    | 07/02 → 05  | ABS                               | 940 371   | 922 181   |
| Carnival 2.5 V6 24V   | 99 → 04   |                                   | 941 941   | 942 942   |
| Carnival 2.9 TD       | 99 → 04   |                                   | 941 941   | 942 942   |
| Carnival 2.9 CRDi     | 01 → 04   |                                   | 941 941   | 942 942   |
| Carnival 3.5 V6 24V   | 02 → 04   |                                   | 941 941   | 942 942   |
| Cerato                | 04/04 → 12/06   |                                   | 921 215   | 922 825   |
| Clarus 1.8i 16V       | 95 → 01   | <del>ABS</del>                    | 940 371   | 922 179   |
| Clarus 1.8i 16V       | 95 → 01   | ABS                               | 940 371   | 922 181   |
| Clarus 2.0i 16V       | 95 → 01   | <del>ABS</del>                    | 940 371   | 922 179   |
| Clarus 2.0i 16V       | 95 → 01   | ABS                               | 940 371   | 922 181   |
| Clarus Wagon 1.8i 16V | 98 → 01   | <del>ABS</del>                    | 940 371   | 922 179   |
| Clarus Wagon 1.8i 16V | 98 → 01   | ABS                               | 940 371   | 922 181   |
| Clarus Wagon 2.0i 16V | 98 → 01   | <del>ABS</del>                    | 940 371   | 922 179   |
| Clarus Wagon 2.0i 16V | 98 → 01   | ABS                               | 940 371   | 922 181   |
| Concord               | 92 → 94   |                                   | 942 768   | 942 738   |
| Picanto               | 04 → 05   |                                   | 951 962   | -   |
| Potentia              | 11/93 → 94  |                                   | 941 784   | 942 736   |
| Pregio 2.7 Diesel     | 99 → 02   |                                   | 942 942   | 922 854   |
| Pride 1.3i            | 91 → 05   | ☐                                 | 941 636   | 942 770   |
| Pride 1.3i            | 91 → 05   | ☐                                 | 941 636   | 942 768   |
| Retona 2.0 16V        | 00 → 04   |                                   | 921 555   | 922 854   |
| Retona 2.0 TD         | 99 → 04   |                                   | 921 555   | 922 854   |
| Rio 1.3i              | 00 → 04   |                                   | 941 636   | -   |
| Rio 1.5i 16V          | 00 → 04   |                                   | 941 636   | -   |
| Sedona                | 99 → 01   |                                   | 941 941   | 942 942   |
| Sephia 1.5i           | 92 → 97   | <del>ABS</del> Ⓞ                  | 941 700   | 922 787   |
| Sephia 1.5i           | 92 → 97   | ABS Ⓞ                             | 941 700   | 922 789   |
| Sephia 1.6i           | 93 → 97   | <del>ABS</del> Ⓞ                  | 941 700   | 922 787   |
| Sephia 1.6i           | 93 → 97   | ABS Ⓞ                             | 941 700   | 922 789   |
| Sephia 1.8i 16V       | 94 → 97   | <del>ABS</del> Ⓞ                  | 941 700   | 922 787   |
| Sephia 1.8i 16V       | 94 → 97   | ABS Ⓞ                             | 941 700   | 922 789   |
| Shuma I 1.5i 16V      | 97 → 08/01  | <del>ABS</del>                    | 941 700   | 922 787   |
| Shuma I 1.5i 16V      | 97 → 08/01  | ABS                               | 941 700   | 922 789   |
| Shuma I 1.8i 16V      | 97 → 08/01  | <del>ABS</del>                    | 941 700   | 922 787   |
| Shuma I 1.8i 16V      | 97 → 08/01  | ABS                               | 941 700   | 922 789   |
| Shuma II 1.6i 16V     | 05/01 → 08/04   | <del>ABS</del>                    | 940 371   | 922 787   |
| Shuma II 1.6i 16V     | 05/01 → 08/04   | ABS                               | 940 371   | 922 789   |
| Shuma II 1.8i 16V     | 04/03 → 08/04   | <del>ABS</del>                    | 940 371   | 922 787   |
| Shuma II 1.8i 16V     | 04/03 → 08/04   | ABS                               | 940 371   | 922 789   |
| Sportage 2WD 2.0i 16V | 99 → 04   |                                   | 921 555   | 922 854   |
| Sportage 4WD 2.0i     | 93 → 04/99  |                                   | 921 555   | 922 557   |
| Sportage 4WD 2.0i 16V | 93 → 04/99  |                                   | 921 555   | 922 557   |
| Sportage 4WD 2.0i 16V | 05/99 → 04  |                                   | 921 555   | 922 854   |



| MODELL/MODEL/MODELE |  | BEMERKUNGEN/REMARKS/<br>REMARQUES   |  |  |
|---------------------|---|---|---|---|
| Sportage 4WD 2.0 TD | 95 → 04/99  |   | 921 555   | 922 557   |
| Sportage 4WD 2.0 TD | 05/99 → 04  |   | 921 555   | 922 854   |
| K2700               | 98 → 01   |  | 941 963   | -   |



## BEMERKUNGEN/REMARKS/ REMARQUES



| MODELL/MODEL/MODELE    |      |    |  |                 |
|------------------------|------|----|--|-----------------|
| 1200, 1300, 1500, 1600 | 71 → | 93 |  | - 802 454       |
| Niva                   | 76 → | -  |  | 04-P213 -       |
| Niva                   | 78 → | 02 |  | 801 656 802 590 |
| Samara                 | 86 → | -  |  | 04-P211 -       |
| Sagona                 | 90 → | 97 |  | 801 442 802 658 |
| Samara                 | 86 → | 97 |  | 801 442 802 658 |
| Taiga                  | 77 → | 90 |  | 801 656 802 590 |

| MODELL/MODEL/MODELE              |  | BEMERKUNGEN/REMARKS/<br>REMARQUES       |  |  |
|----------------------------------|---|---|---|---|
| A 112, A 112 E, A 112 Abarth     | 77 → 05/84  |   | 800 408   | 802 318   |
| A 112, A 112 E, A 112 Abarth     | 05/84 → 86  |   | 800 408   | 802 324   |
| Beta                             | 72 → 84   |   | 801 372   | 802 620   |
| Dedra 1.6 i.e. 8V                | 01/89 → 05/89   | <del>ABS</del> Ch.→27910                | 801 360   | 802 330   |
| Dedra 1.6 i.e. 8V                | 01/89 → 05/89   | ABS Ch.→27910                           | 801 360   | 802 330   |
| Dedra 1.6 i.e. 8V                | 06/89 → 97  | <del>ABS</del> Ch.27911→                | 801 376   | 802 330   |
| Dedra 1.6 i.e. 8V                | 06/89 → 01/93   | ABS Ch.27911→                           | 801 376   | 802 330   |
| Dedra 1.6 i.e. 8V                | 02/93 → 97  | ABS                                     | 801 376   | 802 378   |
| Dedra 1.6 16V                    | 97 → 99   | <del>ABS</del>                          | 800 398   | 802 330   |
| Dedra 1.6 16V                    | 97 → 99   | ABS                                     | 800 398   | 802 378   |
| Dedra 1.8 i.e. 8V                | 01/89 → 05/89   | <del>ABS</del> Ch.→27910                | 800 400   | 802 330   |
| Dedra 1.8 i.e. 8V                | 01/89 → 05/89   | ABS Ch.→27910                           | 800 400   | 802 330   |
| Dedra 1.8 i.e. 8V                | 06/89 → 95  | <del>ABS</del> Ch.27911→                | 800 398   | 802 330   |
| Dedra 1.8 i.e. 8V                | 06/89 → 01/93   | ABS Ch.27911→                           | 800 398   | 802 330   |
| Dedra 1.8 i.e. 8V                | 02/93 → 95  | ABS                                     | 800 398   | 802 378   |
| Dedra 1.8 16V                    | 96 → 99   | <del>ABS</del>                          | 800 398   | 802 330   |
| Dedra 1.8 16V                    | 96 → 99   | ABS                                     | 800 398   | 802 378   |
| Dedra 1.9 Turbo Diesel           | 01/89 → 05/89   | <del>ABS</del> Ch.→27910                | 800 400   | 802 330   |
| Dedra 1.9 Turbo Diesel           | 01/89 → 05/89   | ABS Ch.→27910                           | 800 400   | 802 378   |
| Dedra 1.9 Turbo Diesel           | 06/89 → 99  | <del>ABS</del> Ch.27911→                | 800 398   | 802 330   |
| Dedra 1.9 Turbo Diesel           | 06/89 → 99  | ABS Ch.27911→                           | 800 398   | 802 378   |
| Dedra 2.0 i.e. 8V                | 01/89 → 05/89   | <del>ABS</del> Ch.→27910                | 800 400   | 802 330   |
| Dedra 2.0 i.e. 8V                | 01/89 → 05/89   | ABS Ch.→27910                           | 800 400   | 802 378   |
| Dedra 2.0 i.e. 8V                | 06/89 → 97  | <del>ABS</del> Ch.27911→                | 800 398   | 802 330   |
| Dedra 2.0 i.e. 8V                | 06/89 → 97  | ABS Ch.27911→                           | 800 398   | 802 378   |
| Dedra 2.0 16V                    | 94 → 97   |   | 800 398   | 802 378   |
| Dedra 2.0 Turbo                  | 91 → 92   | <del>ABS</del>                          | 800 398   | 802 330   |
| Dedra 2.0 Turbo                  | 91 → 92   | ABS                                     | 800 398   | 802 378   |
| Dedra 2.0 Turbo 4x4 Integrale    | 91 → 96   |   | 800 398   | 800 400   |
| Delta I 1.3, 1.5                 | 80 → 05/84  |   | 800 304   | 802 318   |
| Delta I 1.3, 1.5                 | 05/84 → 03/88   | Ch.→444357                              | 800 304   | 802 324   |
| Delta I 1.3, 1.5                 | 03/88 → 92  | Ch.444358→                              | 800 366   | 802 324   |
| Delta I 1.6, 1.6 i.e., 1.6 Turbo | 83 → 03/88  | Ch.→444357                              | 800 304   | -   |
| Delta I 1.6, 1.6 i.e., 1.6 Turbo | 03/88 → 92  | Ch.444358→                              | 800 366   | -   |
| Delta I 1.9 Turbo Diesel         | 83 → 03/88  | Ch.→444357                              | 800 304   | -   |
| Delta I 1.9 Turbo Diesel         | 03/88 → 92  | Ch.444358→                              | 800 366   | -   |
| Delta II 1.4 i.e.                | 93 → 99   | <del>ABS</del>                          | 801 376   | 802 330   |
| Delta II 1.4 i.e.                | 93 → 99   | ABS                                     | 801 376   | 802 378   |
| Delta II 1.6 i.e.                | 93 → 99   | <del>ABS</del>                          | 801 376   | 802 330   |
| Delta II 1.6 i.e.                | 93 → 99   | ABS                                     | 801 376   | 802 378   |
| Delta II 1.8 i.e.                | 93 → 99   | <del>ABS</del>                          | 800 398   | 802 330   |
| Delta II 1.8 i.e.                | 93 → 99   | ABS                                     | 800 398   | 802 378   |
| Delta II 1.9 Turbo Diesel        | 93 → 99   | <del>ABS</del>                          | 800 398   | 802 330   |
| Delta II 1.9 Turbo Diesel        | 93 → 99   | ABS                                     | 800 398   | 802 378   |
| Delta II 2.0 16V                 | 93 → 99   | <del>ABS</del>                          | 800 398   | 802 330   |
| Delta II 2.0 16V                 | 93 → 99   | ABS                                     | 800 398   | 802 378   |
| Delta II 2.0 16V Turbo           | 93 → 99   | <del>ABS</del>                          | 801 500   | 802 330   |
| Delta II 2.0 16V Turbo           | 93 → 99   | ABS                                     | 801 500   | 802 378   |
| Delta Integrale 4x4              | 86 → 87   | Ch.→412352                              | 800 304   | 800 304   |
| Delta Integrale 4x4              | 01/88 → 03/88   | Ch.412353→444357                        | 800 400   | 800 304   |
| Delta Integrale 4x4              | 03/88 → 91  | Ch.444358→                              | 800 400   | 800 366   |
| Delta Integrale Evoluzione 4x4   | 91 → 94   |   | 800 400   | 800 400   |
| Kappa 2.0 16V, 2.0 20V           | 94 → 04/98  | Ch.→2084918                             | 801 500   | 802 331   |
| Kappa 2.0 16V, 2.0 20V           | 04/98 → 10/01   | Ch.2084919→ ABS - Active Sensor Bearing | 801 972   | 802 886   |





## BEMERKUNGEN/REMARKS/ REMARQUES









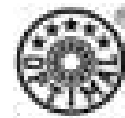











## MODELL/MODEL/MODELE



| MODELL/MODEL/MODELE                 |               | BEMERKUNGEN/REMARKS/<br>REMARQUES       |         |         |
|-------------------------------------|---------------|---|---------|---------|
| Kappa 2.4 20V                       | 94 → 04/98    | Ch.→2084918                             | 801 500 | 802 331 |
| Kappa 2.4 20V                       | 04/98 → 10/01 | Ch.2084919→ ABS - Active Sensor Bearing | 801 972 | 802 886 |
| Kappa 2.4 T.DS.                     | 94 → 04/98    | Ch.→2084918                             | 801 500 | 802 331 |
| Kappa 2.4 JTD                       | 04/98 → 10/01 | Ch.2084919→ ABS - Active Sensor Bearing | 801 972 | 802 886 |
| Kappa 3.0 V6 24V                    | 94 → 04/98    | Ch.→2084918                             | 801 500 | 802 331 |
| Kappa 3.0 V6 24V                    | 04/98 → 10/01 | Ch.2084919→ ABS - Active Sensor Bearing | 801 972 | 802 886 |
| Kappa Coupé 2.0 16V, 2.0 20V        | 94 → 04/98    | Ch.→1002100                             | 801 500 | 802 331 |
| Kappa Coupé 2.0 16V, 2.0 20V        | 04/98 → 10/01 | Ch.1002101→ ABS - Active Sensor Bearing | 801 972 | 802 886 |
| Kappa Coupé 2.4 20V                 | 94 → 04/98    | Ch.→1002100                             | 801 500 | 802 331 |
| Kappa Coupé 2.4 20V                 | 04/98 → 10/01 | Ch.1002101→ ABS - Active Sensor Bearing | 801 972 | 802 886 |
| Kappa Coupé 3.0 V6 24V              | 94 → 04/98    | Ch.→1002100                             | 801 500 | 802 331 |
| Kappa Coupé 3.0 V6 24V              | 04/98 → 10/01 | Ch.1002101→ ABS - Active Sensor Bearing | 801 972 | 802 886 |
| Lybra 1.6 16V                       | 99 → 05       | ABS - Active Sensor Bearing             | 801 838 | 802 839 |
| Lybra 1.8 16V                       | 99 → 05       | ABS - Active Sensor Bearing             | 801 838 | 802 839 |
| Lybra 1.9 JTD                       | 99 → 05       | ABS - Active Sensor Bearing             | 801 972 | 802 839 |
| Lybra 2.0 20V                       | 99 → 05       | ABS - Active Sensor Bearing             | 801 972 | 802 839 |
| Lybra 2.4 JTD                       | 99 → 05       | ABS - Active Sensor Bearing             | 801 972 | 802 839 |
| Musa 1.3 Multijet                   | 04 → 05       | ABS - Active Sensor Bearing             | 801 838 | 802 839 |
| Musa 1.4 16V                        | 04 → 05       | ABS - Active Sensor Bearing             | 801 836 | 802 839 |
| Musa 1.9 Multijet                   | 04 → 05       | ABS - Active Sensor Bearing             | 801 838 | 802 839 |
| Phedra 2.0 16V                      | 02 → 05       | ABS - Active Sensor Bearing             | 681 261 | 682 263 |
| Phedra 2.0 JTD                      | 02 → 05       | ABS - Active Sensor Bearing             | 681 261 | 682 263 |
| Phedra 2.2 JTD                      | 02 → 05       | ABS - Active Sensor Bearing             | 681 261 | 682 263 |
| Phedra 3.0 V6 24V                   | 02 → 05       | ABS - Active Sensor Bearing             | 681 259 | 682 263 |
| Prisma 1.3, 1.5                     | 83 → 05/84    |   | 800 304 | 802 318 |
| Prisma 1.3, 1.5                     | 06/84 → 03/88 | Ch.→444357                              | 800 304 | 802 324 |
| Prisma 1.3, 1.5                     | 03/88 → 89    | Ch.444358→                              | 800 366 | 802 324 |
| Prisma 1.6, 1.6 i.e.                | 83 → 03/88    | Ch.→444357                              | 800 304 | -       |
| Prisma 1.6, 1.6 i.e.                | 03/88 → 89    | Ch.444358→                              | 800 366 | -       |
| Prisma 1.9 Diesel, 1.9 Turbo Diesel | 83 → 03/88    | Ch.→444357                              | 800 304 | -       |
| Prisma 1.9 Diesel, 1.9 Turbo Diesel | 03/88 → 89    | Ch.444358→                              | 800 366 | -       |
| Prisma Integrale 4x4                | 86 → 87       | Ch.→412352                              | 800 304 | 800 304 |
| Prisma Integrale 4x4                | 01/88 → 03/88 | Ch.412353→444357                        | 800 400 | 800 304 |
| Prisma Integrale 4x4                | 03/88 → 89    | Ch. 444358→                             | 800 400 | 800 366 |
| Thema 2.0 8V                        | 85 → 92       | <del>ABS</del>                          | 800 400 | 802 368 |
| Thema 2.0 8V                        | 85 → 92       | ABS Ch.→303503 ⚙️ 90                    | 800 400 | 802 370 |
| Thema 2.0 8V                        | 92 → 92       | ABS Ch. 303504→ ⚙️ 44                   | 801 500 | 802 526 |
| Thema 2.0 8V Turbo                  | 85 → 88       | <del>ABS</del>                          | 800 400 | 802 368 |
| Thema 2.0 8V Turbo                  | 85 → 88       | ABS ⚙️ 90                               | 800 400 | 802 370 |
| Thema 2.0 16V                       | 89 → 92       | <del>ABS</del>                          | 800 400 | 802 368 |
| Thema 2.0 16V                       | 89 → 92       | ABS Ch.→300636 ⚙️ 90                    | 800 400 | 802 370 |
| Thema 2.0 16V                       | 92 → 94       | ABS Ch. 300637→ ⚙️ 44                   | 801 500 | 802 526 |
| Thema 2.0 16V Turbo                 | 89 → 92       | <del>ABS</del>                          | 800 400 | 802 368 |
| Thema 2.0 16V Turbo                 | 89 → 92       | ABS Ch.→303313 ⚙️ 90                    | 800 400 | 802 370 |
| Thema 2.0 16V Turbo                 | 92 → 94       | ABS Ch. 303314→ ⚙️ 44                   | 801 500 | 802 526 |
| Thema 2.5 Turbo Diesel              | 85 → 92       | <del>ABS</del>                          | 800 400 | 802 368 |
| Thema 2.5 Turbo Diesel              | 85 → 08/92    | ABS ⚙️ 90                               | 800 400 | 802 370 |
| Thema 2.5 Turbo Diesel              | 09/92 → 93    | ABS ⚙️ 44                               | -       | 802 526 |
| Thema 2.85 V6                       | 85 → 92       | <del>ABS</del>                          | 800 400 | 802 368 |
| Thema 2.85 V6                       | 85 → 92       | ABS ⚙️ 90                               | 800 400 | 802 370 |
| Thema 3.0 V6                        | 93 → 95       | ABS ⚙️ 44                               | 801 500 | 802 526 |
| Thesis 2.0 20V Turbo                | 02 → 05       | ABS - Active Sensor Bearing             | 801 970 | 802 233 |
| Thesis 2.4 20V                      | 02 → 05       | ABS - Active Sensor Bearing             | 801 970 | 802 233 |
| Thesis 2.4 JTD                      | 02 → 05       | ABS - Active Sensor Bearing             | 801 970 | 802 233 |

| MODELL/MODEL/MODELE     |  | BEMERKUNGEN/REMARKS/<br>REMARQUES       |  |  |
|-------------------------|---|---|---|---|
| Thesis 3.0 V6 24V       | 02 → 05   | ABS - Active Sensor Bearing             | 801 970   | 802 233   |
| Thesis 3.2 V6 24V       | 03 → 05   | ABS - Active Sensor Bearing             | 801 970   | 802 233   |
| Y 10                    | 85 → 95   |   | 801 342   | 802 324   |
| Y 10 4x4                | 87 → 95   |   | 801 342   | 802 444   |
| Y                       | 95 → 04   | <del>ABS</del> Man.GBX                  | 801 362   | 802 330   |
| Y                       | 95 → 98   | ABS Ch.→3336902                         | 801 362   | 802 315   |
| Y                       | 98 → 04   | ABS - Active Sensor Bearing Ch.3336903→ | 801 836   | 802 839   |
| Ypsilon 1.2 8V, 1.2 16V | 10/03 → 04  | ABS - Active Sensor Bearing             | 801 836   | 802 839   |
| Ypsilon 1.3 JTD         | 10/03 → 04  | ABS - Active Sensor Bearing             | 801 838   | 802 839   |
| Ypsilon 1.4 16V         | 10/03 → 04  | ABS - Active Sensor Bearing             | 801 836   | 802 839   |
| Zeta                    | 95 → 02   |   | 681 303   | 682 305   |
| Zeta                    | 98 → 02   |   | 04-P193   | -   |









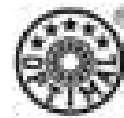

































| MODELL/MODEL/MODELE     |  | BEMERKUNGEN/REMARKS/<br>REMARQUES  |  |  |  |
|-------------------------|---|--|--|---|---|
| Defender                | 95 → 99   | Ch.→JA032850   |  | 880 419   | 880 419   |
| Discovery               | 89 → 92   | Ch.→JA032850   |  | 880 421   | 880 421   |
| Discovery               | 92 → 98   | Ch.JA032851→   |  | 880 419   | 880 419   |
| Freelander              | 02/01 → 05  |  |  | 880 912   | 880 912   |
| Land-Rover Ser. III     | 10/80 → 85  |  |  | 880 812   | 880 812   |
| Land-Rover 90           | 84 → 87   |  |  | 880 812   | 880 812   |
| Land-Rover 90 Defender  | R.H.D 88 → 88   | {Front  →22L06071B ; Rear  →22S08283B} |  | 880 812   | 880 812   |
| Land-Rover 90 Defender  | L.H.D 88 → 88   | {Front  →22L03666B ; Rear  →22S08283B} |  | 880 812   | 880 812   |
| Land-Rover 90 Defender  | R.H.D 88 → 98   | {Front  22L06072B→ ; Rear  22S08284B→} |  | 880 419   | 880 419   |
| Land-Rover 90 Defender  | L.H.D 88 → 98   | {Front  22L03667B→ ; Rear  22S08284B→} |  | 880 419   | 880 419   |
| Land-Rover 109 V8       | 79 → 84   |  |  | 880 812   | 880 812   |
| Land-Rover 110          | R.H.D 84 → 85   | {Front  →20L13358B ; Rear  →21S22954B} |  | 880 812   | 880 812   |
| Land-Rover 110          | L.H.D 84 → 85   | {Front  →21L10631B ; Rear  →21S22954B} |  | 880 812   | 880 812   |
| Land-Rover 110          | R.H.D 85 → 86   | {Front  20L13359B→ ; Rear  21S22955B→} |  | 880 419   | 880 419   |
| Land-Rover 110          | L.H.D 85 → 86   | {Front  21L10632B→ ; Rear  21S22955B→} |  | 880 419   | 880 419   |
| Land-Rover 110 Defender | 87 → 98   |  |  | 880 419   | 880 419   |
| Land-Rover 130 Defender | 91 → 95   |  |  | 880 419   | 880 419   |
| Range Rover             | 70 → 06/85  |  |  | 880 812   | 880 812   |
| Range Rover             | 07/85 → 92  | <del>ABS</del> Ch.→JA624516  |  | 880 421   | 880 421   |
| Range Rover             | 92 → 02/02  | <del>ABS</del> Ch.JA624517→  |  | 880 419   | 880 419   |
| Range Rover             | 90 → 02/02  | ABS  |  | 880 419   | 880 419   |



| MODELL/MODEL/MODELE |                  |            | BEMERKUNGEN/REMARKS/<br>REMARQUES |   |         |
|---------------------|------------------|------------|-----------------------------------|---|---------|
|                     |                  |            |                                   |   |         |
| ES 300              | (MCV20)          | 96 → 00    |                                   | 981 475   | -       |
| GS 300              | (JZS147)         | 93 → 07/97 |                                   | 981 805   | 982 559 |
| IS 200              | (GXE10)          | 99 → 04    |                                   | 981 849   | -       |
| LS 400              | (UCF10)          | 89 → 94    |                                   | 981 805   | 982 559 |
| LS 400              | (UCF20)          | 94 → 00    |                                   | 981 805   | 982 559 |
| LS 400              | (UCF21)          | 94 → 00    |                                   | 981 805   | 982 559 |
| RX 300              | (MCU10W, MCU15W) | 98 → 03    |                                   | 981 475   | 982 431 |



| MODELL/MODEL/MODELE            |  | BEMERKUNGEN/REMARKS/<br>REMARQUES   |                        |  |
|--------------------------------|---|---|------------------------|---|
| Leyland-Daf 200                | 04/89 → 91  |   | 2.0t, 2.3t, 2.5t       | 681 907 -   |
| Leyland-Daf 200                | 04/89 → 91  |   | 2.8t                   | 681 907 -   |
| Leyland-Daf 400 Ser.           | 89 → 91   |  |                        | 681 907 -   |
| Leyland-Daf 400 Ser.           | 89 → 91   |  |                        | 681 907 682 920   |
| Sherpa 200, 230, 250, 255 (K2) | 83 → 04/89  |   | Hub AAR3200            | 681 907 -   |
| Sherpa 280 (K2)                | 83 → 85   |   | Hub AAR3200 Ch.→258339 | 681 907 -   |
| Sherpa 280 (K2)                | 85 → 04/89  |   | Ch.258340→             | 681 907 -   |
| Sherpa 285, 310, 350 (MT210)   | 83 → 84   |  | Ch.→237809             | - 682 920   |
| Sherpa 285, 310, 350 (MT210)   | 84 → 85   |  | Ch.237886→             | 681 907 -   |
| Sherpa 285, 310, 350 (MT210)   | 84 → 85   |  | Ch.237810→             | 681 907 682 920   |
| Sherpa 285, 300, 310, 350      | 85 → 89   |  |                        | 681 907 -   |
| Sherpa 285, 300, 310, 350      | 85 → 89   |  |                        | 681 907 682 920   |





















| MODELL/MODEL/MODELE  |              |  | BEMERKUNGEN/REMARKS/<br>REMARQUES  |  |  |
|----------------------|--------------|---|--|---|---|
| 121 I                | (DA)         | 11/86 → 10/90   |               | 941 636   | 942 768   |
| 121 I                | (DA)         | 11/86 → 10/90   |               | 941 636   | 942 770   |
| 121 I                | (DA)         | 11/86 → 10/90   |               | 941 636   | 942 768   |
| 121 I                | (DA)         | 11/86 → 10/90   |               | 941 636   | 942 770   |
| 121 II               | (DB)         | 11/90 → 03/96   | <del>ABS</del>   | 941 874   | 941 842   |
| 121 II               | (DB)         | 11/90 → 03/96   | ABS  | 941 874   | 942 177   |
| 121 III              | (JASM, JBSM) | 03/96 → 98  | <del>ABS</del>   | 941 874   | 941 842   |
| 121 III              | (JASM, JBSM) | 03/96 → 98  | ABS  | 941 874   | -   |
| 323 1.1              | (BD)         | 08/80 → 04/85   |  | 941 634   | 942 674   |
| 323 1.1              | (BF)         | 05/85 → 88  |               | 941 636   | 942 568   |
| 323 1.1              | (BF)         | 05/85 → 88  |               | 941 636   | 942 570   |
| 323 1.3              | (BD)         | 08/80 → 04/85   |  | 941 634   | 942 674   |
| 323 1.3              | (BF)         | 05/85 → 88  |               | 941 636   | 942 568   |
| 323 1.3              | (BF)         | 05/85 → 88  |               | 941 636   | 942 570   |
| 323 1.3i             | (BG)         | 06/89 → 95  |  Ch.500001→   | 941 700   | 942 569   |
| 323 1.3i             | (BG)         | 06/89 → 95  |  Ch.500001→   | 941 700   | 942 773   |
| 323 1.4              | (BF)         | 05/85 → 88  |               | 941 636   | 942 568   |
| 323 1.4              | (BF)         | 05/85 → 88  |               | 941 636   | 942 570   |
| 323 1.4i             | (BG)         | 06/89 → 95  |  Ch.500001→   | 941 700   | 942 569   |
| 323 1.4i             | (BG)         | 06/89 → 95  |  Ch.500001→   | 941 700   | 942 773   |
| 323 1.4i             | (BA)         | 95 → 98   | <del>ABS</del>   | 941 700   | 942 569   |
| 323 1.4i             | (BA)         | 95 → 98   | ABS  | 941 700   | 942 773   |
| 323 1.4i             | (BJ)         | 05/98 → 03  | <del>ABS</del>   | 941 700   | 942 569   |
| 323 1.4i             | (BJ)         | 05/98 → 03  | ABS  | 941 700   | 942 773   |
| 323 1.5              | (BD)         | 08/80 → 04/85   |  | 941 634   | 942 674   |
| 323 1.5              | (BF)         | 05/85 → 88  |             | 941 636   | 942 568   |
| 323 1.5              | (BF)         | 05/85 → 88  |             | 941 636   | 942 570   |
| 323 1.5i 16V         | (BA)         | 07/94 → 98  | <del>ABS</del>   | 941 700   | 942 569   |
| 323 1.5i 16V         | (BA)         | 07/94 → 98  | ABS  | 941 700   | 942 773   |
| 323 1.5i 16V         | (BJ)         | 05/98 → 03  | <del>ABS</del>   | 941 700   | 942 569   |
| 323 1.5i 16V         | (BJ)         | 05/98 → 03  | ABS  | 941 700   | 942 773   |
| 323 1.6i             | (BF)         | 05/85 → 88  |             | 941 636   | 942 568   |
| 323 1.6i             | (BF)         | 05/85 → 88  |             | 941 636   | 942 570   |
| 323 1.6i             | (BG)         | 06/89 → 98  |  Ch.500001→ | 941 700   | 942 569   |
| 323 1.6i             | (BG)         | 06/89 → 98  |  Ch.500001→ | 941 700   | 942 773   |
| 323 1.6i 16V         | (BJ)         | 05/98 → 03  | <del>ABS</del>   | 941 700   | 942 569   |
| 323 1.6i 16V         | (BJ)         | 05/98 → 03  | ABS  | 941 700   | 942 773   |
| 323 1.7 Diesel       | (BF)         | 05/85 → 88  |             | 941 636   | 942 568   |
| 323 1.7 Diesel       | (BF)         | 05/85 → 88  |             | 941 636   | 942 570   |
| 323 1.7 Diesel       | (BG)         | 06/89 → 95  |  Ch.500001→ | 941 700   | 942 569   |
| 323 1.7 Diesel       | (BG)         | 06/89 → 95  |  Ch.500001→ | 941 700   | 942 773   |
| 323 1.7 Turbo Diesel | (BA)         | 05/94 → 98  | <del>ABS</del>   | 941 700   | 942 569   |
| 323 1.7 Turbo Diesel | (BA)         | 05/94 → 98  | ABS  | 941 700   | 942 773   |
| 323 1.8i 16V         | (BG)         | 06/89 → 95  |  Ch.500001→ | 941 700   | 942 569   |
| 323 1.8i 16V         | (BG)         | 06/89 → 95  |  Ch.500001→ | 941 700   | 942 773   |
| 323 1.8i 16V         | (BA)         | 07/94 → 98  | <del>ABS</del>   | 941 700   | 942 569   |
| 323 1.8i 16V         | (BA)         | 07/94 → 98  | ABS  | 941 700   | 942 773   |
| 323 1.8i 16V         | (BJ)         | 05/98 → 03  | ABS  | 941 700   | 942 773   |
| 323 1.9i 16V         | (BG)         | 06/89 → 95  |  Ch.500001→ | 941 700   | 942 569   |
| 323 1.9i 16V         | (BG)         | 06/89 → 95  |  Ch.500001→ | 941 700   | 942 773   |
| 323 1.9i 16V         | (BA)         | 07/94 → 98  | <del>ABS</del>   | 941 700   | 942 569   |
| 323 1.9i 16V         | (BA)         | 07/94 → 98  | ABS  | 941 700   | 942 773   |
| 323 1.9i 16V         | (BJ)         | 05/98 → 03  | ABS  | 941 700   | 942 773   |
| 323 2.0i 16V         | (BJ)         | 09/00 → 03  | <del>ABS</del>   | 941 700   | 942 569   |











## MODELL/MODEL/MODELE









































## BEMERKUNGEN/REMARKS/ REMARQUES







|                       |      |               |   |         |         |
|-----------------------|------|---------------|---|---------|---------|
| 323 2.0i 16V          | (BJ) | 09/00 → 03    | ABS   | 941 700 | 942 773 |
| 323 2.0i 24V          | (BA) | 05/94 → 98    | ABS    | 941 700 | 942 569 |
| 323 2.0i 24V          | (BA) | 05/94 → 98    | ABS    | 941 700 | 942 773 |
| 323 2.0 Diesel        | (BA) | 10/96 → 98    | <del>ABS</del>  | 941 700 | 942 569 |
| 323 2.0 Diesel        | (BA) | 10/96 → 98    | ABS   | 941 700 | 942 773 |
| 323 2.0 Diesel        | (BJ) | 05/98 → 03    | <del>ABS</del>  | 941 700 | 942 569 |
| 323 2.0 Diesel        | (BJ) | 05/98 → 03    | ABS   | 941 700 | 942 773 |
| 323 2.0 Turbo Diesel  | (BJ) | 05/98 → 03    | <del>ABS</del>  | 941 700 | 942 569 |
| 323 2.0 Turbo Diesel  | (BJ) | 05/98 → 03    | ABS   | 941 700 | 942 773 |
| 323 4WD 1.3           | (BG) | 06/89 → 95    | Ch.500001→ {Rear  }  | 941 700 | 941 700 |
| 323 4WD 1.6i          | (BG) | 06/89 → 95    | Ch.500001→ {Rear  }  | 941 700 | 941 700 |
| 323 4WD 1.6 GT        | (BF) | 10/85 → 95    |   | 940 632 | 940 632 |
| 323 4WD 1.7 Diesel    | (BG) | 06/89 → 95    | Ch.500001→ {Rear  }  | 941 700 | 941 700 |
| 323 4WD 1.8           | (BG) | 06/89 → 95    | Ch.500001→ {Rear  }  | 941 700 | 941 700 |
| 323 4WD 1.8 16V       | (BG) | 06/89 → 95    | Ch.500001→ {Rear  }  | 940 371 | 940 371 |
| 323 Wagon 1.5         | (BW) | 86 → 95       |   | 941 636 | 942 818 |
| 323 Wagon 1.5         | (BW) | 86 → 95       |   | 941 636 | 942 820 |
| 323 Wagon 1.6         | (BW) | 86 → 95       |   | 941 636 | 942 818 |
| 323 Wagon 1.6         | (BW) | 86 → 95       |   | 941 636 | 942 820 |
| 323 Wagon 1.6 4WD     | (BW) | 89 → 95       |    | 940 632 | 940 632 |
| 323 Wagon 1.7 Diesel  | (BW) | 86 → 95       |   | 941 636 | 942 818 |
| 323 Wagon 1.7 Diesel  | (BW) | 86 → 95       |   | 941 636 | 942 820 |
| 6                     | (GG) | 02 → 04       |   | 940 371 | 942 273 |
| 6 Sport               | (GG) | 02 → 04       |   | 940 371 | 942 273 |
| 6 Sport 4WD           | (GG) | 02 → 04       |   | 940 371 | 940 371 |
| 6 Station Wagon       | (GY) | 02 → 04       |    | 940 371 | 942 273 |
| 626                   | (GC) | 83 → 06/87    |   | 941 734 | 942 566 |
| 626                   | (GD) | 06/87 → 09/89 |   | 941 602 | 942 672 |
| 626 1.6               | (GD) | 09/89 → 10/91 | Ch.GD500001→700000  | 941 602 | 942 672 |
| 626 1.8               | (GD) | 09/89 → 10/91 | Ch.GD500001→700000  | 941 602 | 942 672 |
| 626 1.8i              | (GE) | 08/91 → 06/97 | <del>ABS</del> Ch.GE100001→   | 940 371 | 942 381 |
| 626 1.8i              | (GE) | 05/94 → 06/97 | ABS Ch.GE100001→  | 940 371 | 941 862 |
| 626 1.8i 16V          | (GF) | 04/97 → 02    | <del>ABS</del>  | 940 371 | 942 381 |
| 626 1.8i 16V          | (GF) | 04/97 → 06/99 | ABS   | 940 371 | 941 862 |
| 626 1.8i 16V          | (GF) | 07/99 → 02    | ABS   | 940 371 | 942 291 |
| 626 1.9i 16V          | (GE) | 08/91 → 06/97 | <del>ABS</del> Ch.GE100001→   | 940 371 | 942 381 |
| 626 1.9i 16V          | (GE) | 05/94 → 06/97 | ABS Ch.GE100001→  | 940 371 | 941 862 |
| 626 1.9i 16V          | (GF) | 04/97 → 02    | <del>ABS</del>  | 940 371 | 942 381 |
| 626 1.9i 16V          | (GF) | 04/97 → 06/99 | ABS   | 940 371 | 941 862 |
| 626 1.9i 16V          | (GF) | 07/99 → 02    | ABS   | 940 371 | 942 291 |
| 626 2.0               | (GD) | 09/89 → 10/91 | Ch.GD500001→700000  | 941 602 | 942 672 |
| 626 2.0i 16V GT 4WS   | (GD) | 09/89 → 10/91 | Ch.GD500001→700000  | 941 602 | 942 987 |
| 626 2.0i 16V          | (GE) | 08/91 → 06/97 | <del>ABS</del> Ch.GE100001→   | 940 371 | 942 381 |
| 626 2.0i 16V          | (GE) | 05/94 → 06/97 | ABS Ch.GE100001→  | 940 371 | 941 862 |
| 626 2.0i 16V          | (GF) | 04/97 → 02    | <del>ABS</del>  | 940 371 | 942 381 |
| 626 2.0i 16V          | (GF) | 04/97 → 02    | ABS   | 940 371 | 942 291 |
| 626 2.0 Diesel        | (GD) | 09/89 → 10/91 | Ch.GD500001→700000  | 941 602 | 942 672 |
| 626 2.0 Diesel        | (GE) | 03/92 → 97    | <del>ABS</del>  | 940 371 | 942 381 |
| 626 2.0 Diesel        | (GE) | 03/92 → 97    | ABS   | 940 371 | 941 862 |
| 626 2.0i Turbo Diesel | (GF) | 98 → 02       | <del>ABS</del>  | 940 371 | 942 381 |
| 626 2.0i Turbo Diesel | (GF) | 98 → 02       | ABS   | 940 371 | 942 291 |
| 626 2.2i              | (GD) | 09/89 → 10/91 | Ch.GD500001→700000  | 941 602 | 942 672 |
| 626 2.5i 24V          | (GE) | 08/91 → 98    | <del>ABS</del> Ch.GE100001→   | 940 371 | 942 381 |
| 626 2.5i 24V          | (GE) | 05/94 → 98    | ABS Ch.GE100001→  | 940 371 | 941 862 |

| MODELL/MODEL/MODELE         |              |  | BEMERKUNGEN/REMARKS/<br>REMARQUES   |  |  |  |
|-----------------------------|--------------|---|---|--|---|---|
| 626 4WD / 4WS 1.8i          | (GE)         | 08/91 → 94  | Ch.GE100001→  |  | 940 371   | 940 371   |
| 626 4WD / 4WS 2.0i 16V      | (GE)         | 08/91 → 05/97   | Ch.GE100001→  |  | 940 371   | 940 371   |
| 626 4WD / 4WS 2.2i          | (GD)         | 09/89 → 10/91   | Ch.GD500001→700000    |  | 941 602   | 940 371   |
| 626 4WD / 4WS 2.5i 24V      | (GE)         | 08/91 → 94  | Ch.GE100001→  |  | 940 371   | 940 371   |
| 626 Wagon 1.8               | (GV)         | 10/89 → 97  |   |  | 941 602   | 942 987   |
| 626 Wagon 1.8i 16V          | (GW)         | 10/97 → 02  |   |  | 940 371   | 942 273   |
| 626 Wagon 1.9i 16V          | (GW)         | 10/97 → 02  |   |  | 940 371   | 942 273   |
| 626 Wagon 2.0               | (GV)         | 10/89 → 97  |   |  | 941 602   | 942 987   |
| 626 Wagon 2.0i 16V          | (GW)         | 10/97 → 02  |   |  | 940 371   | 942 273   |
| 626 Wagon 2.0 Diesel        | (GV)         | 10/89 → 97  |   |  | 941 602   | 942 987   |
| 626 Wagon 2.0i Turbo Diesel | (GW)         | 10/98 → 02  |   |  | 940 371   | 942 273   |
| 626 Wagon 2.2i              | (GV)         | 10/89 → 97  |   |  | 941 602   | 942 987   |
| 626 Wagon 4WD 2.2i          | (GV)         | 10/89 → 02  |   |  | 941 602   | 942 987   |
| 626 Wagon 4WD 2.3i 16V      | (GY)         | 07/02 → 03  |   |  | 940 371   | 940 371   |
| 929                         | (HB, HC, HD) | 82 → 86   |   |  | -   | 942 738   |
| 929                         | (HC12)       | 07/87 → 90  |   |  | 941 784   | 942 736   |
| 929 L                       | (LA4MV)      | 80 → 86   |    |  | -   | 942 619   |
| Demio 1.4i 16V              | (DW)         | 98 → 04   | <del>ABS</del>  |  | 941 874   | 941 842   |
| Demio 1.4i 16V              | (DW)         | 98 → 04   | ABS   |  | 941 874   | 942 177   |
| Demio 1.5i 16V              | (DW)         | 00 → 04   | <del>ABS</del>  |  | 941 874   | 941 842   |
| Demio 1.5i 16V              | (DW)         | 00 → 04   | ABS   |  | 941 874   | 942 177   |
| MPV I 2.5 Turbo Diesel      | (LV)         | 95 → 99   |   |  | 941 967   | 942 989   |
| MPV I 3.0i 18V              | (LV)         | 95 → 99   |   |  | 941 967   | 942 989   |
| MPV I 3.0i 24V DOHC         | (LV)         | 07/94 → 99  |   |  | 941 967   | 942 989   |
| MPV II 2.0i 16V             | (LW)         | 06/99 → 04  |   |  | 940 371   | 942 273   |
| MPV II 2.0 DI               | (LW)         | 02/02 → 04  |   |  | 940 371   | 942 273   |
| MPV II 2.3i 16V             | (LW)         | 02/02 → 04  |   |  | 940 371   | 942 273   |
| MPV II 2.5 V6 24V           | (LW)         | 02/02 → 04  |   |  | 940 371   | 942 273   |
| MPV II 3.0 V6 24V           | (LW)         | 02/02 → 04  |   |  | 940 371   | 942 273   |
| MX-3                        | (EC)         | 05/91 → 00  | <del>ABS</del>   |  | 941 700   | 942 569   |
| MX-3                        | (EC)         | 05/91 → 00  | ABS    |  | 941 700   | 942 773   |
| MX-5 I                      | (NA)         | 91 → 04/98  | <del>ABS</del>  |  | 941 842   | 941 840   |
| MX-5 I                      | (NA)         | 91 → 04/98  | ABS   |  | 941 951   | 941 840   |
| MX-5 II                     | (NB)         | 05/98 → 04  | <del>ABS</del>  |  | 941 842   | 941 700   |
| MX-5 II                     | (NB)         | 05/98 → 04  | ABS   |  | 941 951   | 941 700   |
| MX 5 III                    | (NC)         | 03/05 → 12/06   |   |  | -   | 940 371   |
| MX-6 2.0i 16V               | (GE)         | 07/91 → 97  | <del>ABS</del>  |  | 940 371   | 942 381   |
| MX-6 2.0i 16V               | (GE)         | 07/91 → 97  | ABS   |  | 940 371   | 941 862   |
| MX-6 2.5i 24V               | (GE)         | 07/91 → 97  | <del>ABS</del>  |  | 940 371   | 942 381   |
| MX-6 2.5i 24V               | (GE)         | 07/91 → 97  | ABS   |  | 940 371   | 941 862   |
| MX-6 2.5i 24V 4WS           | (GE)         | 07/91 → 97  |   |  | 940 371   | 940 371   |
| Premacy                     | (CP)         | 99 → 04   |   |  | 941 700   | 942 273   |
| RX-7 1.3 Wankel Twin Turbo  | (FD)         | 92 → 98   |   |  | 940 371   | 942 988   |
| Xedos 6 1.6i 16V            | (CA)         | 93 → 00   | <del>ABS</del>  |  | 940 371   | 942 381   |
| Xedos 6 1.6i 16V            | (CA)         | 93 → 00   | ABS   |  | 940 371   | 941 862   |
| Xedos 6 2.0i V6 24V         | (CA)         | 92 → 00   | <del>ABS</del>  |  | 940 371   | 942 381   |
| Xedos 6 2.0i V6 24V         | (CA)         | 92 → 00   | ABS   |  | 940 371   | 941 862   |
| Xedos 9 2.0i V6 24V         | (TA)         | 93 → 11/99  | ABS   |  | 940 371   | 941 862   |
| Xedos 9 2.0i V6 24V         | (TA)         | 11/99 → 00  | ABS   |  | 940 371   | 942 273   |
| Xedos 9 2.3i V6 24V         | (TA)         | 95 → 00   | ABS   |  | 940 371   | 941 862   |
| Xedos 9 2.5i V6 24V         | (TA)         | 93 → 11/99  | ABS   |  | 940 371   | 941 862   |
| Xedos 9 2.5i V6 24V         | (TA)         | 11/99 → 00  | ABS   |  | 940 371   | 942 273   |
| B 1600                      | (UF)         | 85 → 87   |  Ch.→501109  |  | 941 565   | -   |
| B 2000                      | (UF)         | 85 → 87   |  Ch.→516113  |  | 941 565   | -   |











| MODELL/MODEL/MODELE |      | BEMERKUNGEN/REMARKS/<br>REMARQUES |  |         |         |
|---------------------|------|-----------------------------------|--|---------|---------|
| B 2200              | (UF) | 85 → 87                           |  Ch.→505778   | 941 565 | -       |
| B 2500 Diesel       | (UF) | 96 → 06/99                        |   | 941 565 | 942 695 |
| B 2500 Diesel       | (UN) | 06/99 → 02                        |   | 941 565 | -       |
| Courier             |      | 03/85 → 86                        |   | -       | 942 695 |
| E 1400              |      | 88 → 96                           |   | 941 687 | 942 619 |
| E 1800              |      | 84 → 86                           |    | -       | 942 651 |
| E 1800              |      | 88 → 96                           |  {Front  }   | 941 565 | 942 695 |
| E 1800              |      | 88 → 96                           |  {Front  }   | 941 687 | 942 619 |
| E 2000              |      | 84 → 86                           |    | -       | 942 651 |
| E 2000              |      | 88 → 96                           |  {Front  }  | 941 687 | 942 619 |
| E 2000              |      | 88 → 96                           |             | 941 565 | 942 695 |
| E 2000              |      | 88 → 96                           |             | 941 565 | 942 651 |
| E 2200              |      | 84 → 86                           |    | -       | 942 651 |
| E 2200 Diesel       |      | 88 → 96                           |    | 941 565 | 942 695 |
| E 2200 Diesel       |      | 88 → 96                           |    | 941 565 | 942 651 |
| Econovan 2WD 2200   |      | 84 → 85                           |    | 941 687 | -       |

| MODELL/MODEL/MODELE |      |  | BEMERKUNGEN/REMARKS/<br>REMARQUES   |  |  |  |
|---------------------|------|---|---|--|---|---|
| 190                 | W201 | 83 → 83   | Ch.→003513  |  | 401 277   | 402 116   |
| 190 D               | W201 | 83 → 83   | Ch.→000043  |  | 401 277   | 402 116   |
| 190 E               | W201 | 83 → 83   | Ch.→006892  |  | 401 277   | 402 116   |
| 190 E 1.8           | W201 | 86 → 93   | Ch.003514→, 000044→, 006893→  |  | 401 048   | 402 116   |
| 190 E 2.3           | W201 | 86 → 93   | Ch.003514→, 000044→, 006893→  |  | 401 048   | 402 116   |
| 190 E 2.3 16V       | W201 | 84 → 93   |   |  | 401 042   | 402 116   |
| 190 E 2.5           | W201 | 88 → 93   | Ch.003514→, 000044→, 006893→  |  | 401 048   | 402 116   |
| 190 E 2.5 16V       | W201 | 88 → 93   |   |  | 401 042   | 402 116   |
| 190 E 2.6           | W201 | 86 → 93   | Ch.003514→, 000044→, 006893→  |  | 401 048   | 402 116   |
| 200/8, 200 D/8      | W115 | 68 → 76   |   |  | 401 222   | 402 030   |
| 200, 200 D          | W123 | 76 → 85   | <del>ABS</del>  |  | 401 028   | 402 030   |
| 200, 200 D          | W123 | 80 → 85   | ABS   |  | 401 126   | 402 030   |
| 200                 | T124 | 86 → 93   |   |  | 401 042   | 402 080   |
| 200                 | W124 | 85 → 93   |   |  | 401 042   | 402 116   |
| 200 CE Cabriolet    | C124 | 90 → 94   |   |  | 401 042   | 402 116   |
| 200 CE Coupé        | C124 | 90 → 94   |   |  | 401 042   | 402 116   |
| 220/8, 220 D/8      | W115 | 68 → 76   |   |  | 401 222   | 402 030   |
| 220 D               | 123  | 76 → 85   | <del>ABS</del>  |  | 401 028   | 402 030   |
| 220 D               | 123  | 80 → 85   | ABS   |  | 401 126   | 402 030   |
| 220 E               | W124 | 93 → 93   |   |  | 401 042   | 402 116   |
| 220 TE              | T124 | 93 → 94   |   |  | 401 042   | 402 080   |
| 220 CE Cabriolet    | C124 | 93 → 94   |   |  | 401 042   | 402 116   |
| 220 CE Coupé        | C124 | 93 → 94   |   |  | 401 042   | 402 116   |
| 230/4, 230/6, 230/8 | W114 | 68 → 76   |   |  | 401 222   | 402 030   |
| 230/4, 230/6, 230/8 | W115 | 68 → 76   |   |  | 401 222   | 402 030   |
| 230, 230 T          | 123  | 76 → 85   | <del>ABS</del>  |  | 401 028   | 402 030   |
| 230, 230 T          | 123  | 80 → 85   | ABS   |  | 401 126   | 402 030   |
| 230 CE Coupé        | C124 | 87 → 94   |   |  | 401 042   | 402 116   |
| 230 E               | T124 | 86 → 93   |   |  | 401 042   | 402 080   |
| 230 E               | T124 | 86 → 93   |  |  | 401 165   | 402 080   |
| 230 E               | W124 | 85 → 93   |   |  | 401 042   | 402 116   |
| 230 TE              | T124 | 86 → 93   |   |  | 401 042   | 402 080   |
| 230 TE              | T124 | 86 → 92   |  |  | 401 165   | 402 080   |
| 240 D, 240 D 3.0    | W115 | 74 → 76   |   |  | 401 222   | 402 030   |
| 240 D, 240 TD       | 123  | 76 → 85   | <del>ABS</del>  |  | 401 028   | 402 030   |
| 240 D, 240 TD       | 123  | 80 → 85   | ABS   |  | 401 126   | 402 030   |
| 250/8               | W114 | 68 → 76   |   |  | 401 222   | 402 030   |
| 250 C/CE Coupé      | W114 | 69 → 76   |   |  | 401 222   | 402 030   |
| 250, 250 T          | 123  | 76 → 85   | <del>ABS</del>  |  | 401 028   | 402 030   |
| 250, 250 T          | 123  | 80 → 85   | ABS   |  | 401 126   | 402 030   |
| 250 D               | T124 | 86 → 93   |   |  | 401 042   | 402 080   |
| 250 D               | T124 | 86 → 93   |  |  | 401 165   | 402 080   |
| 250 D               | W124 | 85 → 93   |   |  | 401 042   | 402 116   |
| 250 D               | W124 | 85 → 93   |  |  | 401 165   | 402 080   |
| 250 D Turbo Diesel  | W124 | 85 → 93   |   |  | 401 042   | 402 116   |
| 250 TD              | T124 | 89 → 93   |   |  | 401 042   | 402 080   |
| 250 TD Turbo Diesel | T124 | 86 → 93   |   |  | 401 042   | 402 080   |
| 260 E               | T124 | 86 → 93   |   |  | 401 078   | 402 080   |
| 260 E               | W124 | 85 → 93   |   |  | 401 042   | 402 116   |
| 260 E               | W124 | 85 → 93   |  |  | 401 165   | 402 080   |
| 260 E 4-Matic       | W124 | 87 → 93   |   |  | 401 096   | 402 116   |
| 260 SE              | W126 | 86 → 92   | <del>ABS</del>  |  | 401 028   | 402 030   |
| 260 SE              | W126 | 86 → 92   | ABS   |  | 401 126   | 402 030   |
| 280                 | W114 | 72 → 76   |   |  | 401 276   | 402 030   |



| MODELL/MODEL/MODELE    |      | BEMERKUNGEN/REMARKS/<br>REMARQUES |   |   |         |
|------------------------|------|-----------------------------------|---|---|---------|
| 280 C, 280 CE, 280 E   | W114 | 72 → 76                           |   | 401 222   | 402 030 |
| 280 S, 280 SE, 280 SEL | W116 | 73 → 76                           |   | 401 028   | 402 030 |
| 280 C/CE Coupé         | 123  | 77 → 85                           | <del>ABS</del>  | 401 028   | 402 030 |
| 280 C/CE Coupé         | 123  | 80 → 85                           | ABS   | 401 126   | 402 030 |
| 280, 280 E, 280 TE     | 123  | 76 → 85                           | <del>ABS</del>  | 401 028   | 402 030 |
| 280, 280 E, 280 TE     | 123  | 80 → 85                           | ABS   | 401 126   | 402 030 |
| 280 S, 280 SE, 280 SEL | W126 | 80 → 85                           |   | 401 028   | 402 030 |
| 280 SL                 | R107 | 75 → 85                           |   | 401 222   | 402 030 |
| 280 SLC Coupé          | C107 | 75 → 85                           |   | 401 222   | 402 030 |
| 280 E                  | W124 | 93 → 93                           |   | 401 042   | 402 116 |
| 280 E                  | W124 | 93 → 93                           |  | 401 165   | 402 080 |
| 280 E                  | T124 | 93 → 95                           |   | 401 165   | 402 080 |
| 280 TE                 | T124 | 93 → 95                           |  | 401 165   | 402 080 |
| 280 TE                 | T124 | 93 → 95                           |   | 401 042   | 402 080 |
| 300 D, 300 TD          | W123 | 76 → 85                           | <del>ABS</del>  | 401 028   | 402 030 |
| 300 D, 300 TD          | W123 | 80 → 85                           | ABS   | 401 126   | 402 030 |
| 300                    | C124 | 87 → 94                           |   | 401 042   | 402 116 |
| 300 Cabriolet          | C124 | 90 → 94                           |   | 401 165   | 402 116 |
| 300                    | T124 | 86 → 93                           |   | 401 042   | 402 080 |
| 300 4-Matic            | T124 | 87 → 93                           |   | 401 096   | 402 080 |
| 300                    | W124 | 85 → 93                           |   | 401 042   | 402 116 |
| 300 4-Matic            | W124 | 87 → 93                           |   | 401 096   | 402 116 |
| 300                    | W140 | 91 → 93                           |   | 401 082   | 402 242 |
| 300 SE, 300 SEL        | W126 | 86 → 92                           | <del>ABS</del>  | 401 028   | 402 030 |
| 300 SE, 300 SEL        | W126 | 86 → 92                           | ABS   | 401 126   | 402 030 |
| 300 SL                 | R107 | 85 → 88                           |   | 401 042   | 402 030 |
| 300 SL                 | R129 | 89 → 93                           |   | 401 078   | 402 116 |
| 300 SL-24              | R129 | 89 → 93                           |   | 401 165   | 402 116 |
| 320 CE Coupé           | C124 | 93 → 93                           |   | 401 042   | 402 116 |
| 320 E Cabriolet        | C124 | 93 → 93                           |   | 401 165   | 402 116 |
| 320 E                  | W124 | 93 → 93                           |   | 401 042   | 402 116 |
| 320 TE                 | T124 | 93 → 94                           |   | 401 042   | 402 080 |
| 350 SE, 350 SEL        | W116 | 75 → 80                           |   | 401 028   | 402 030 |
| 350 SL                 | R107 | 71 → 85                           |   | 401 222   | 402 030 |
| 350 SLC Coupé          | C107 | 71 → 85                           |   | 401 222   | 402 030 |
| 380 SL                 | R107 | 80 → 85                           |   | 401 222   | 402 030 |
| 380 SE, 380 SEL        | W126 | 80 → 85                           | <del>ABS</del>  | 401 028   | 402 030 |
| 380 SE, 380 SEL        | W126 | 80 → 85                           | ABS   | 401 126   | 402 030 |
| 380 SLC Coupé          | C107 | 80 → 85                           |   | 401 222   | 402 030 |
| 380 SEC Coupé          | C126 | 82 → 85                           |   | 401 028   | 402 030 |
| 400                    | W140 | 91 → 93                           |   | 401 082   | 402 242 |
| 400 E                  | W124 | 93 → 93                           |   | 401 078   | 402 116 |
| 420 SE, 420 SEL        | W126 | 86 → 92                           |   | 401 126   | 402 030 |
| 420 SEC Coupé          | C126 | 86 → 92                           |   | 401 126   | 402 030 |
| 420 SL                 | R107 | 85 → 88                           |   | 401 042   | 402 030 |
| 450 SE, 450 SEL        | W116 | 73 → 80                           |   | 401 028   | 402 030 |
| 450 SEL 6.9            | W116 | 75 → 80                           |   | 401 028   | 402 030 |
| 450 SL                 | R107 | 73 → 85                           |   | 401 222   | 402 030 |
| 450 SLC Coupé          | C107 | 73 → 85                           |   | 401 222   | 402 030 |
| 500                    | W140 | 91 → 93                           |   | 401 082   | 402 242 |
| 500 E                  | W124 | 90 → 93                           |   | 401 165   | 402 116 |
| 500 SE, 500 SEL        | W126 | 80 → 85                           |   | 401 028   | 402 030 |
| 500 SE, 500 SEL        | W126 | 86 → 92                           |   | 401 126   | 402 030 |
| 500 SEC Coupé          | C126 | 82 → 85                           |   | 401 028   | 402 030 |



| MODELL/MODEL/MODELE          |      |  | BEMERKUNGEN/REMARKS/<br>REMARQUES   |  |  |  |
|------------------------------|------|---|---|--|---|---|
| 500 SEC Coupé                | C126 | 86 → 92   |   |  | 401 126   | 402 030   |
| 500 SEC Coupé                | C140 | 92 → 93   |   |  | 401 082   | 402 242   |
| 500 SL                       | R107 | 80 → 85   |    | Ch.→034958   | 401 222   | 402 030   |
| 500 SL                       | R107 | 85 → 88   |    | Ch.034959→   | 401 042   | 402 030   |
| 500 SL                       | R129 | 89 → 93   |   |  | 401 165   | 402 116   |
| 500 SLC                      | C107 | 80 → 85   |   |  | 401 222   | 402 030   |
| 560 SE, 560 SEL              | W126 | 86 → 92   |   |  | 401 126   | 402 030   |
| 560 SEC Coupé                | C126 | 86 → 92   |   |  | 401 126   | 402 030   |
| 600 SE, 600 SEL              | W140 | 91 → 93   |   |  | 401 082   | 402 242   |
| 600 SEC-V12 Coupé            | C140 | 92 → 93   |   |  | 401 082   | 402 242   |
| 600 SL                       | R129 | 89 → 93   |   |  | 401 165   | 402 116   |
| A-class                      | W168 | 97 → 02/01  |   | Ch.→J568589 {Rear  25x55x43 }   | 401 047   | 402 063   |
| A-class                      | W168 | 02/01 → 08/04   |   | Ch.J568590→ {Rear  25x55x53,5 } | 401 047   | 402 073   |
| A-class                      | W169 | 09/04 → 12/06   |   |  | -   | 402 827   |
| B-class                      | W245 | 09/04 → 12/06   |   |  | -   | 402 827   |
| C-class                      | W202 | 93 → 03/01  |    |  | 401 078   | 402 116   |
| C-class                      | T202 | 96 → 03/01  |    |  | 401 078   | 402 116   |
| C-class                      | W203 | 05/00 → 04  |   |  | 401 157   | 402 159   |
| CL-class Coupé               | C140 | 97 → 03   |   |  | 401 082   | 402 242   |
| CLK-class                    | C208 | 97 → 04   |   |  | 401 078   | 402 116   |
| CLK-class Cabriolet          | A208 | 98 → 04   |   |  | 401 078   | 402 116   |
| CLK-class                    | C209 | 06/02 → 04  |   |  | 401 078   | 402 116   |
| CLK-class Cabriolet          | A209 | 02/03 → 04  |   |  | 401 078   | 402 116   |
| CLS-class 350 Coupé          | C219 | 10/04 → 12/04   |   |  | 401 501   | 402 505   |
| CLS-class 500 Coupé          | C219 | 10/04 → 12/04   |   |  | 401 501   | 402 505   |
| E-class 180 Kompressor       | W211 | 03/02 → 04  |   |  | 401 501   | 402 505   |
| E-class 200                  | W124 | 06/93 → 06/95   |   |  | 401 042   | 402 116   |
| E-class 200 Diesel           | W124 | 06/93 → 06/95   |   |  | 401 042   | 402 116   |
| E-class 200 Diesel           | W210 | 94 → 03/02  |   |  | 401 078   | 402 116   |
| E-class 200 Cabriolet, Coupé | C124 | 93 → 02   |   |  | 401 042   | 402 116   |
| E-class 200, 200 Kompressor  | W210 | 06/95 → 03/02   |   |  | 401 078   | 402 116   |
| E-class 200, 200 Kompressor  | T210 | 96 → 02   |   |  | 401 078   | 402 243   |
| E-class 200                  | W211 | 03/02 → 05  |   |  | 401 501   | 402 505   |
| E-class 220                  | W124 | 06/93 → 06/95   |   |  | 401 042   | 402 116   |
| E-class 220 Cabriolet, Coupé | C124 | 93 → 02   |   |  | 401 042   | 402 116   |
| E-class 220 Diesel, CDI      | W210 | 07/95 → 03/02   |   |  | 401 078   | 402 116   |
| E-class 220 CDI              | W211 | 03/02 → 05  |   |  | 401 501   | 402 505   |
| E-class 230                  | W210 | 96 → 03/02  |   |  | 401 078   | 402 116   |
| E-class 230                  | T210 | 96 → 02   |   |  | 401 078   | 402 243   |
| E-class 240                  | W210 | 06/95 → 03/02   |   |  | 401 078   | 402 116   |
| E-class 240                  | T210 | 96 → 02   |   |  | 401 078   | 402 243   |
| E-class 240                  | W211 | 03/02 → 05  |   |  | 401 501   | 402 505   |
| E-class 250 Diesel           | W124 | 07/93 → 06/95   |   |  | 401 042   | 402 116   |
| E-class 250 Diesel           | W124 | 07/93 → 06/95   |  |  | 401 165   | 402 080   |
| E-class 250 Diesel           | T124 | 06/93 → 06/96   |   |  | 401 042   | 402 080   |
| E-class 250 Diesel           | T124 | 06/93 → 06/96   |  |  | 401 165   | 402 080   |
| E-class 250 Diesel           | W210 | 07/95 → 03/02   |   |  | 401 078   | 402 116   |
| E-class 250 Diesel           | T210 | 96 → 02   |   |  | 401 078   | 402 243   |
| E-class 250 Turbo Diesel     | W124 | 06/93 → 06/95   |   |  | 401 042   | 402 116   |
| E-class 250 Turbo Diesel     | T124 | 94 → 06/96  |   |  | 401 042   | 402 080   |
| E-class 250 Turbo Diesel     | W210 | 07/97 → 03/02   |   |  | 401 078   | 402 116   |
| E-class 250 Turbo Diesel     | T210 | 96 → 02   |   |  | 401 078   | 402 243   |
| E-class 270 CDI              | W211 | 03/02 → 05  |   |  | 401 501   | 402 505   |
| E-class 280                  | W124 | 06/93 → 06/95   |   |  | 401 042   | 402 116   |



























































## MODELL/MODEL/MODELE







## BEMERKUNGEN/REMARKS/ REMARQUES



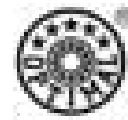

































|                                  |      |               |  |         |         |
|----------------------------------|------|---------------|--|---------|---------|
| E-class 280                      | W124 | 06/93 → 06/95 |  | 401 165 | 402 080 |
| E-class 280                      | W210 | 96 → 03/02    |  | 401 078 | 402 116 |
| E-class 280                      | T210 | 96 → 02       |  | 401 078 | 402 243 |
| E-class 280 4-Matic              | W210 | 96 → 03/02    |  | 400 061 | 402 116 |
| E-class 280 4-Matic              | T210 | 96 → 02       |  | 400 061 | 402 243 |
| E-class 290 Turbo Diesel         | W210 | 96 → 07/99    |  | 401 078 | 402 116 |
| E-class 290 Turbo Diesel         | T210 | 96 → 07/99    |  | 401 078 | 402 243 |
| E-class 300                      | W124 | 94 → 95       |  | 401 096 | 402 116 |
| E-class 300 Diesel               | W124 | 93 → 95       |  | 401 042 | 402 116 |
| E-class 300 Diesel               | T124 | 06/93 → 06/96 |  | 401 042 | 402 080 |
| E-class 300 Diesel               | W210 | 07/95 → 06/97 |  | 401 078 | 402 116 |
| E-class 300 Turbo Diesel         | W124 | 93 → 95       |  | 401 042 | 402 116 |
| E-class 300 Turbo Diesel         | T124 | 93 → 06/96    |  | 401 042 | 402 080 |
| E-class 300 Turbo Diesel         | W210 | 96 → 07/99    |  | 401 078 | 402 116 |
| E-class 300 Turbo Diesel         | T210 | 96 → 07/99    |  | 401 078 | 402 243 |
| E-class 300 4-Matic              | W124 | 94 → 95       |  | 401 096 | 402 116 |
| E-class 300 4-Matic              | T124 | 06/93 → 06/96 |  | 401 096 | 402 080 |
| E-class 300 Turbo Diesel 4-Matic | W124 | 93 → 95       |  | 401 096 | 402 116 |
| E-class 300 Turbo Diesel 4-Matic | T124 | 06/93 → 06/96 |  | 401 096 | 402 080 |
| E-class 320                      | W124 | 06/93 → 06/95 |  | 401 042 | 402 116 |
| E-class 320                      | W210 | 06/95 → 03/02 |  | 401 078 | 402 116 |
| E-class 320                      | T210 | 96 → 02       |  | 401 078 | 402 243 |
| E-class 320 Cabriolet            | C124 | 94 → 02       |  | 401 165 | 402 116 |
| E-class 320 Coupé                | C124 | 06/93 → 02    |  | 401 042 | 402 116 |
| E-class 320 4-Matic              | W210 | 06/97 → 03/02 |  | 400 061 | 402 116 |
| E-class 320 4-Matic              | T210 | 97 → 02       |  | 400 061 | 402 243 |
| E-class 320                      | W211 | 03/02 → 05    |  | 401 501 | 402 505 |
| E-class 320 CDI                  | W211 | 03/02 → 05    |  | 401 501 | 402 505 |
| E-class 420                      | W124 | 06/93 → 06/95 |  | 401 078 | 402 116 |
| E-class 420                      | W210 | 96 → 06/97    |  | 401 078 | 402 116 |
| E-class 420                      | T210 | 96 → 02       |  | 401 078 | 402 243 |
| E-class 430                      | W210 | 06/95 → 03/02 |  | 401 078 | 402 116 |
| E-class 430                      | T210 | 96 → 02       |  | 401 078 | 402 243 |
| E-class 500                      | W124 | 06/93 → 06/95 |  | 401 078 | 402 116 |
| E-class 500                      | W211 | 03/02 → 05    |  | 401 501 | 402 505 |
| E-class 55 AMG                   | W210 | 08/97 → 03/02 |  | 401 078 | 402 116 |
| E-class 55 AMG                   | T210 | 96 → 02       |  | 401 078 | 402 243 |
| E-class 55 AMG                   | W211 | 03/02 → 05    |  | 401 501 | 402 505 |
| M-class                          | W163 | 98 → 06/05    |  | 400 051 | 400 051 |
| S-class                          | W140 | 94 → 98       |  | 401 082 | 402 242 |
| S-class                          | W220 | 98 → 04       |  | 401 083 | 402 081 |
| S-class Coupé                    | C140 | 92 → 99       |  | 401 082 | 402 242 |
| S-class Coupé                    | C215 | 99 → 04       |  | 401 083 | 402 243 |
| SL-class                         | R129 | 94 → 04       |  | 401 165 | 402 116 |
| SL-class Roadster                | R230 | 01 → 04       |  | 401 083 | 402 081 |
| SLK-class                        | R170 | 96 → 04/04    |  | 401 078 | 402 116 |
| SLK-class                        | R171 | 03/04 → 12/06 |  | 401 157 | -       |
| Vaneo                            |      | 01 → 05       |  | 401 047 | 402 063 |
| Viano                            |      | 03 → 05       |  | -       | 402 063 |
| 207 D                            |      | 78 → 90       |  | 401 028 | 402 050 |
| 208                              |      | 78 → 82       |  | 401 028 | 402 050 |
| 208 D                            |      | 90 → 94       |  | 401 028 | 402 050 |
| 209 D                            |      | 84 → 90       |  | 401 028 | 402 050 |
| 210                              |      | 83 → 94       |  | 401 028 | 402 050 |









| MODELL/MODEL/MODELE        |  | BEMERKUNGEN/REMARKS/<br>REMARQUES  |  |  |
|----------------------------|---|--|---|---|
| 210 D                      | 89 → 94   |   | 401 028   | 402 050   |
| 307 D                      | 78 → 90   |   730.403, 730.404, 730.445, 730.446 | 401 028   | 402 050   |
| 307 D                      | 78 → 90   |   730.405, 730.407, 730.447, 730.448 | 401 137   | 402 050   |
| 308                        | 78 → 82   |   | 401 028   | 402 050   |
| 308 D                      | 90 → 94   |   730.403, 730.404, 730.445, 730.446 | 401 028   | 402 050   |
| 308 D                      | 90 → 94   |   730.405, 730.407, 730.447, 730.448 | 401 137   | 402 050   |
| 309 D                      | 83 → 90   |   730.403, 730.404, 730.445, 730.446 | 401 028   | 402 050   |
| 309 D                      | 83 → 90   |   730.405, 730.407, 730.447, 730.448 | 401 137   | 402 050   |
| 310                        | 83 → 94   |   | 401 028   | 402 050   |
| 310 D                      | 89 → 94   |   730.403, 730.404, 730.445, 730.446 | 401 028   | 402 050   |
| 310 D                      | 89 → 94   |   730.405, 730.407, 730.447, 730.448 | 401 137   | 402 050   |
| G-class 200 GE 4x4         | 90 → 93   |   730.305                            | 401 212   | 402 050   |
| G-class 230 G 4x4          | 79 → 82   |   →7000560                           | 401 100   | 402 050   |
| G-class 230 G 4x4          | 82 → 82   |   7000561→                           | 401 104   | 402 050   |
| G-class 230 GE 4x4         | 82 → 82   |   →7000560                           | 401 100   | 402 050   |
| G-class 230 GE 4x4         | 82 → 93   |   7000561→                           | 401 104   | 402 050   |
| G-class 230 GE 4x4         | 90 → 93   |   730.305                            | 401 212   | 402 050   |
| G-class 240 GD 4x4         | 79 → 82   |   →7000560                           | 401 100   | 402 050   |
| G-class 240 GD 4x4         | 82 → 85   |   7000561→                         | 401 104   | 402 050   |
| G-class 250 GD 4x4         | 87 → 93   |   | 401 104   | 402 050   |
| G-class 250 GD 4x4         | 90 → 93   |   730.305                        | 401 212   | 402 050   |
| G-class 280 GE 4x4         | 79 → 82   |   →7000560                       | 401 100   | 402 050   |
| G-class 280 GE 4x4         | 82 → 88   |   7000561→                       | 401 104   | 402 050   |
| G-class 300 GD 4x4         | 79 → 82   |   →7000560                       | 401 100   | 402 050   |
| G-class 300 GD 4x4         | 82 → 93   |   7000561→                       | 401 104   | 402 050   |
| G-class 300 GD 4x4         | 90 → 93   |   730.305                        | 401 212   | 402 050   |
| G-class 300 GE 4x4         | 90 → 93   |   730.391                        | 401 212   | 402 050   |
| G-class 350 GD Turbo 4x4   | 90 → 93   |   730.392                        | 401 212   | 402 050   |
| G-class                    | 94 → 98   |   | 401 212   | 402 050   |
| MB 100 D                   | 87 → 92   |  Ch.→128165   | 401 214   | 402 216   |
| MB 100 D                   | 92 → 93   |  Ch.128166→   | 401 214   | 402 143   |
| Sprinter 208 D, 212 D, 214 | 95 → 05/06  |   | 401 137   | 402 117   |
| Sprinter 308 D, 312 D, 314 | 95 → 05/06  |   | 401 137   | 402 117   |
| Sprinter 408 D, 412 D, 414 | 95 → 05/06  |                                  | 401 137   | 402 117   |
| Sprinter 408 D, 412 D, 414 | 96 → 05/06  |                                  | 401 137   | 402 119   |
| V-class                    | 97 → 05   |   | 400 107   | 400 107   |
| Vito                       | W638 96 → 04  |   | 400 107   | 400 107   |



| MODELL/MODEL/MODELE |  | BEMERKUNGEN/REMARKS/<br>REMARQUES |  |  |
|---------------------|---|-----------------------------------|---|---|
| Mini Cooper         | 01 → 10/06  |                                   | 501 161   | 502 163   |
| Mini Cooper         | 11/06 → 06  |                                   | -   | 502 599   |
| Mini Cooper S       | 02 → 10/06  |                                   | 501 161   | 502 163   |
| Mini Cooper S       | 11/06 → 05  |                                   | -   | 502 599   |
| Mini One            | 00 → 05   |                                   | 501 161   | 502 163   |
| Mini One D          | 03 → 05   |                                   | 501 161   | 502 163   |
| Mini Works          | 03 → 05   |                                   | 501 161   | 502 163   |

| MODELL/MODEL/MODELE               |        |  | BEMERKUNGEN/REMARKS/<br>REMARQUES   |  |  |
|-----------------------------------|--------|---|---|---|---|
| 3000 GT 4WD / 4WS                 | (Z16A) | 92 → 00   |   | 951 756   | 952 993   |
| Carisma 1.6                       | (DA1A) | 95 → 02/99  | ABS  13"   | 951 409   | 952 405   |
| Carisma 1.6                       | (DA1A) | 95 → 02/99  | ABS  13"   | 951 409   | 952 551   |
| Carisma 1.6                       | (DA1A) | 02/99 → 05  |  14"       | 951 604   | 952 417   |
| Carisma 1.8                       | (DA2A) | 95 → 05   |  14"       | 951 604   | 952 417   |
| Carisma 1.9 TD                    | (DA4A) | 95 → 02/99  | ABS  13"   | 951 409   | 952 405   |
| Carisma 1.9 TD                    | (DA4A) | 95 → 02/99  | ABS  13"   | 951 409   | 952 551   |
| Carisma 1.9 TD                    | (DA4A) | 02/99 → 00  |  14"       | 951 604   | 952 417   |
| Carisma 1.9 DI-D                  | (DA5A) | 00 → 05   |  14"       | 951 604   | 952 417   |
| Colt 1.2                          | (A15)  | 79 → 84   |   | -   | 920 752   |
| Colt 1.4                          | (A15)  | 79 → 84   |   | -   | 920 752   |
| Colt 1.4 Turbo                    | (A15)  | 82 → 84   |   | 951 606   | 920 752   |
| Colt (C11, C12, C13, C14, C15)    |        | 84 → 88   |   | 951 606   | 952 710   |
| Colt (C51, C52)                   |        | 04/88 → 91  |   | 951 606   | 952 678   |
| Colt (C53)                        |        | 04/88 → 91  |   | 951 606   | 952 676   |
| Colt (C54)                        |        | 04/88 → 91  |   | 951 606   | 952 678   |
| Colt (C58)                        |        | 04/88 → 91  |   | 951 606   | 952 676   |
| Colt 1.1                          |        | 10/04 → 12/06   |   | 951 409   | 952 405   |
| Colt 1.3i (CA1A, CB1A)            |        | 12/91 → 11/95   |   | 951 409   | 952 405   |
| Colt 1.3i 16V (CJ1A, CK1A)        |        | 11/95 → 05/03   |   | 951 409   | 952 405   |
| Colt 1.5 (CA2A, CB2A)             |        | 12/91 → 11/95   |   | 951 409   | 952 405   |
| Colt 1.3                          |        | 06/04 → 12/06   |   | 951 409   | 952 405   |
| Colt 1.5 (CB3A)                   |        | 12/91 → 11/95   | {Rear  } | 951 409   | 952 405   |
| Colt 1.5 (CB3A)                   |        | 12/91 → 11/95   | {Rear  } | 951 409   | 952 551   |
| Colt 1.5 (CJ2A)                   |        | 11/95 → 05/03   |   | 951 409   | 952 405   |
| Colt 1.5 (CK2A)                   |        | 11/95 → 05/03   | {Rear  } | 951 409   | 952 405   |
| Colt 1.5                          |        | 06/04 → 12/06   |   | 951 409   | 952 405   |
| Colt 1.5 (CZT)                    |        | 06/04 → 12/06   |   | 951 409   | 952 405   |
| Colt 1.5 DI-D                     |        | 08/04 → 12/06   |   | 951 409   | 952 405   |
| Colt 1.6i 16V (CA4A, CB4A)        |        | 12/91 → 11/95   |   | 951 409   | 952 405   |
| Colt 1.6i 16V (CJ4A, CK4A)        |        | 11/95 → 05/03   | ABS   | 951 409   | 952 405   |
| Colt 1.8 GTI 16V (CA5A, CB5A)     |        | 12/91 → 11/95   |   | 951 409   | 952 405   |
| Colt 1.8 Diesel (CA5A, CB5A)      |        | 12/91 → 11/95   |   | 951 409   | 952 405   |
| Colt 2.0 Diesel (CB8A)            |        | 12/91 → 11/95   |   | 951 409   | 952 405   |
| Colt Cabriolet 1.5 (CZC)          |        | 05/06 → 12/06   |   | 951 409   | 952 405   |
| Colt Cabriolet 1.5 Turbo (CZC)    |        | 05/06 → 12/06   |   | 951 409   | 952 405   |
| Cordia (A212A)                    |        | 83 → 86   |   | 951 606   | 920 752   |
| Eclipse 2.0i 16V (D22A)           |        | 91 → 95   |   | 951 604   | 952 995   |
| Eclipse 2.0i 16V (D32A)           |        | 95 → 00   |   | -   | 952 997   |
| Galant 1.6 (A12, A16)             |        | 78 → 84   |          | 920 752   | -   |
| Galant 1.6 (E31)                  |        | 12/87 → 91  |   | 951 606   | 920 752   |
| Galant 1.8 (E32)                  |        | 12/87 → 91  | ABS   | 951 604   | 920 752   |
| Galant 1.8 (E32)                  |        | 10/89 → 91  | ABS   | 951 604   | 952 608   |
| Galant 1.8 (E52)                  |        | 01/92 → 04/95   |   | 991 902   | 992 894   |
| Galant 1.8 Turbo Diesel (E34)     |        | 12/87 → 09/92   |   | 951 604   | 920 752   |
| Galant 2.0 (A12, A16)             |        | 78 → 84   |          | 951 756   | -   |
| Galant 2.0 (E15)                  |        | 85 → 87   |   | 951 604   | 920 752   |
| Galant 2.0 GTI 16V (E33)          |        | 88 → 92   |   | 951 604   | 952 608   |
| Galant 2.0 GTI 16V 4WD (E38, E39) |        | 88 → 92   | 4WS   | 951 604   | 952 993   |
| Galant 2.0 (E54, E55)             |        | 01/92 → 04/95   |   | 991 902   | 992 894   |
| Galant 2.0 (E64)                  |        | 01/92 → 11/94   |   | 991 902   | 992 894   |
| Galant 2.0 (EA7A)                 |        | 05/00 → 03  |   | 991 902   | 992 894   |
| Galant 2.0 Diesel (E57)           |        | 01/92 → 04/95   |   | 991 902   | 992 894   |
| Galant 2.3 Turbo Diesel (A16)     |        | 78 → 84   |          | 951 756   | -   |

| MODELL/MODEL/MODELE       |              | BEMERKUNGEN/REMARKS/<br>REMARQUES |   |  |  |
|---------------------------|--------------|-----------------------------------|---|---|---|
| Galant 2.4                | (E16)        | 87 → 88                           |   | 951 604   | 920 752   |
| Galant 2.4                | (E56A)       | 93 → 05/94                        |   | 991 902   | 992 894   |
| Galant 2.4                | (EA3A)       | 06/96 → 03                        |   | 991 902   | 992 894   |
| Galant 2.5                | (E98A)       | 06/94 → 08/94                     |   | 991 902   | 992 894   |
| Galant 2.5                | (EC5A)       | 05/00 → 03                        |   | 991 902   | 992 894   |
| Galant Sapporo 1.6        | (A121A)      | 79 → 84                           |            | 920 752   | -   |
| Galant Sapporo 2.0        | (A123A)      | 79 → 84                           |            | 951 756   | -   |
| Galant Sapporo 2.0 Turbo  | (A123A)      | 79 → 84                           |            | 951 756   | -   |
| Galant Sigma 1.6          | (A121A)      | 77 → 84                           |   | 920 752   | -   |
| Galant Sigma 1.8          | (E12A)       | 87 → 96                           |   | 951 606   | -   |
| Galant Sigma 2.0          | (A123A)      | 77 → 84                           |            | 920 752   | -   |
| Galant Sigma 2.0          | (A123V)      | 78 → 12/78                        |            | 920 752   | -   |
| Galant Sigma 2.0          | (A123V)      | 79 → 84                           | LHD   | 951 756   | -   |
| Galant Sigma 2.0          | (E15AK,E17A) | 10/86 → 04/94                     |   | 951 604   | 951 756   |
| Galopper 2.5 Turbo Diesel | (JK)         | 99 → 04                           |   | 951 722   | -   |
| Galopper 3.0i V6 12V      | (JK)         | 99 → 04                           |   | 951 722   | -   |
| Lancer 1.2                | (A17)        | 75 → 84                           |   | 920 752   | 952 832   |
| Lancer 1.3                | (C61)        | 04/88 → 12/91                     |   | 951 606   | 952 678   |
| Lancer 1.3                | (CA1A, CB1A) | 12/91 → 11/94                     |   | 951 409   | 952 405   |
| Lancer 1.3                | (CJ1A, CK1A) | 11/95 → 00                        |   | 951 409   | 952 405   |
| Lancer 1.4                | (A72)        | 75 → 79                           |            | 920 752   | 952 832   |
| Lancer 1.4                | (A72)        | 77 → 79                           |            | 920 752   | -   |
| Lancer 1.5 12V            | (C62, C72)   | 04/88 → 12/91                     |   | 951 606   | 952 678   |
| Lancer 1.5                | (CA2A, CB2A) | 12/91 → 11/94                     |   | 951 409   | 952 405   |
| Lancer 1.5                | (CB3A)       | 12/91 → 11/94                     | {Rear  } | 951 409   | 952 405   |
| Lancer 1.5                | (CB3A)       | 12/91 → 11/94                     | {Rear  } | 951 409   | 952 551   |
| Lancer 1.5                | (CJ2A)       | 11/95 → 00                        |   | 951 409   | 952 405   |
| Lancer 1.5                | (CK2A)       | 11/95 → 00                        | {Rear  } | 951 409   | 952 405   |
| Lancer 1.6                | (A17)        | 77 → 84                           |   | 920 752   | -   |
| Lancer 1.6                | (C63, C73)   | 04/88 → 12/91                     |   | 951 606   | 952 676   |
| Lancer 1.6                | (CA4A, CB4A) | 12/91 → 11/94                     |   | 951 409   | 952 405   |
| Lancer 1.6                | (CJ4A, CK4A) | 11/95 → 00                        | ABS   | 951 409   | 952 405   |
| Lancer 1.6                | (CB4W)       | 93 → 00                           |   | 951 409   | 952 279   |
| Lancer 1.6 4WD            | (CD4W)       | 93 → 00                           |   | 951 604   | 952 996   |
| Lancer 1.8 Diesel         | (C64, C74)   | 04/88 → 12/91                     |   | 951 606   | 952 678   |
| Lancer 1.8                | (CA5A, CB5A) | 12/91 → 11/94                     |   | 951 409   | 952 405   |
| Lancer 1.8 4WD            | (C37V, C77A) | 04/88 → 94                        |   | 951 606   | -   |
| Lancer 2.0 Turbo          | (A17)        | 80 → 84                           |   | 951 756   | -   |
| Lancer 2.0 Diesel         | (CB8A)       | 12/91 → 00                        | ABS   | 951 409   | 952 405   |
| Lancer 2.0 Diesel         | (CB8A)       | 12/91 → 00                        | ABS   | 951 409   | 952 279   |
| Lancer F 1.2              | (A15)        | 82 → 84                           |   | -   | 920 752   |
| Lancer F 1.3              | (C11)        | 84 → 92                           |          | 951 606   | 952 710   |
| Lancer F 1.4              | (A15)        | 83 → 84                           |   | -   | 920 752   |
| Lancer F 1.4 Turbo        | (A17)        | 82 → 84                           |   | 951 606   | 920 752   |
| Lancer F 1.5              | (C12)        | 84 → 92                           |          | 951 606   | 952 710   |
| Lancer F 1.5              | (C12)        | 86 → 92                           |          | 951 606   | 920 752   |
| Lancer F 1.8              | (C37)        | 84 → 92                           |          | 951 606   | 952 710   |
| Lancer F 1.8 Diesel       | (C14)        | 84 → 92                           |          | 951 606   | 952 710   |
| Mirage 1.5                | (C12A)       | 85 → 88                           |   | 951 606   | 952 710   |
| Mirage 1.5                | (C52A)       | 04/88 → 05/91                     |   | 951 606   | 952 678   |
| Mirage 1.5                | (CA2A, CB2A) | 06/92 → 94                        |   | 951 409   | 952 405   |
| Mirage 1.6                | (C13A)       | 85 → 88                           |   | 951 606   | 952 710   |
| Mirage 1.6                | (C53A)       | 04/88 → 05/91                     |   | 951 606   | 952 676   |
| Mirage 1.8                | (CA5A)       | 06/92 → 94                        |   | 951 409   | 952 405   |

| MODELL/MODEL/MODELE             |                    |  | BEMERKUNGEN/REMARKS/<br>REMARQUES  |  |  |
|---------------------------------|--------------------|---|--|---|---|
| Mirage 1.8                      | (CB5A)             | 06/92 → 05/93   | <del>ABS</del>   | 951 409   | 952 405   |
| Mirage 1.8                      | (CB5A)             | 06/92 → 05/93   | ABS  | 951 409   | 952 551   |
| Mirage 1.8                      | (CB5A)             | 06/93 → 94  | {Rear  }          | 951 409   | 952 405   |
| Mirage 1.8                      | (CB5A)             | 06/93 → 94  | {Rear  }          | 951 409   | 952 551   |
| Montero 3.0i V6                 | (V43W)             | 10/91 → 07/93   |  | 951 722   | 952 769   |
| Montero 3.5i V6                 | (V45W)             | 08/93 → 00  |  | 951 722   | 952 769   |
| Pajero I 2.3 Turbo Diesel       | (L042, L048)       | 83 → 11/90  |  | 951 722   | 952 661   |
| Pajero I 2.5                    | (L042, L047, L048) | 83 → 11/90  |  | 951 722   | 952 661   |
| Pajero I 2.5 Turbo Diesel       | (L044, L049)       | 87 → 11/90  |  | 951 722   | 952 661   |
| Pajero I 2.5 Turbo Diesel       | (L144, L149)       | 89 → 04/91  |  | 951 722   | 952 661   |
| Pajero I 2.6                    | (L042, L047, L048) | 83 → 11/90  |  | 951 722   | 952 661   |
| Pajero I 3.0i V6                | (L141/6)           | 89 → 04/91  |  | 951 722   | 952 661   |
| Pajero II 1.8 GDI               | (V2_W, V4_W)       | 98 → 04/00  |  | 951 722   | 952 769   |
| Pajero II 2.0 Diesel            | (V26, V46)         | 07/93 → 04/00   |  | 951 722   | 952 769   |
| Pajero II 2.4                   | (V2_W, V4_W)       | 91 → 04/00  |  | 951 722   | 952 769   |
| Pajero II 2.5 Turbo Diesel      | (V24, V44)         | 91 → 04/94  |  | 951 722   | 952 769   |
| Pajero II 2.5 Turbo Diesel      | (V2_W, V4_W)       | 91 → 04/03  |  | 951 722   | 952 769   |
| Pajero II 2.8 Turbo Diesel      | (V2_W, V4_W)       | 94 → 04/00  |  | 951 722   | 952 769   |
| Pajero II 3.0i V6               | (V23, V43)         | 91 → 95   |  | 951 722   | 952 769   |
| Pajero II 3.0i V6 24V           | (V23, V43)         | 94 → 04/00  |  | 951 722   | 952 769   |
| Pajero II 3.5i V6 24V           | (V25, V45)         | 07/93 → 04/00   |  | 951 722   | 952 769   |
| Pajero III 3.2 DI-D             | (V60)              | 04/00 → 04  |  | 951 833   | -   |
| Pajero III 3.5i V6 24V          | (V60)              | 04/00 → 04  |  | 951 833   | -   |
| Pajero Classic 2.5 Turbo Diesel | (V2_W)             | 02 → 04/05  |  | 951 722   | 952 769   |
| Pajero Classic 3.2 DI-D         | (V2_W)             | 05/05 → 06  |  | 951 833   | -   |
| Pajero Pinin 1.8 GDI            | (H66W)             | 99 → 03   |  | 951 409   | -   |
| Pajero Sport 2.5 Turbo Diesel   | (K94W)             | 12/98 → 02  |  | 951 722   | 952 297   |
| Pajero Sport 3.0i V6 24V        | (K96W)             | 12/98 → 02  |  | 951 722   | 952 297   |
| Santamo 2.0 16V                 |                    | 99 → 04   |  | 951 604   | -   |
| Sigma 3.0 V6                    | (F16A, F07W)       | 90 → 96   |  | 951 971   | 952 995   |
| Space Gear 2.0 16V              | (PA/B3V/W)         | 95 → 00   | <del>ABS</del>   | -   | 952 758   |
| Space Gear 2.0 16V              | (PA/B3V/W)         | 95 → 00   | ABS  | -   | 952 297   |
| Space Gear 2.4i                 | (PA4W)             | 95 → 00   | <del>ABS</del>   | -   | 952 758   |
| Space Gear 2.4i                 | (PA4W)             | 95 → 00   | ABS  | -   | 952 297   |
| Space Gear 2.5 Turbo Diesel     | (PA/B5V/W)         | 95 → 00   | <del>ABS</del>   | -   | 952 758   |
| Space Gear 2.5 Turbo Diesel     | (PA/B5V/W)         | 95 → 00   | ABS  | -   | 952 297   |
| Space Gear 2.5 Turbo Diesel 4WD | (PD5V/W)           | 95 → 00   |  | -   | 952 297   |
| Space Runner 1.8i 16V           | (N11W)             | 91 → 99   | <del>ABS</del>   | 951 604   | 952 994   |
| Space Runner 1.8i 16V           | (N11W)             | 91 → 99   | ABS  | 951 604   | -   |
| Space Runner 1.8i 16V 4WD       | (N21W)             | 92 → 99   |  | 951 604   | -   |
| Space Runner 2.0 16V            | (N1/2_W)           | 97 → 99   | <del>ABS</del>   | 951 604   | 952 994   |
| Space Runner 2.0 Turbo Diesel   | (N18W)             | 96 → 99   | <del>ABS</del>   | 951 604   | 952 994   |
| Space Runner 2.0 Turbo Diesel   | (N18W)             | 96 → 99   | ABS  | 951 604   | -   |
| Space Star 1.3 16V              | (DG0)              | 98 → 04   |  | 951 409   | -   |
| Space Star 1.6 16V              | (DG0)              | 01 → 04   |  | 951 409   | -   |
| Space Star 1.8 GDI              | (DG0)              | 98 → 04   |  | 951 409   | -   |
| Space Star 1.9 DI-D             | (DG0)              | 01 → 04   |  | 951 409   | -   |
| Space Wagon 1.8                 | (D04)              | 06/86 → 05/91   |  | 951 606   | 920 752   |
| Space Wagon 1.8                 | (N31W)             | 06/91 → 10/98   | <del>ABS</del>  | 951 604   | 952 415   |
| Space Wagon 1.8                 | (N31W)             | 06/92 → 10/98   | ABS             | 951 604   | 952 417   |
| Space Wagon 1.8                 | (N35W)             | 05/91 → 10/98   | <del>ABS</del>  | 951 604   | 952 415   |
| Space Wagon 1.8                 | (N35W)             | 05/91 → 10/98   | ABS             | 951 604   | 952 417   |
| Space Wagon 1.8 4WD             | (N41W)             | 05/91 → 05/92   |  | 951 604   | -   |
| Space Wagon 1.8 Turbo Diesel    | (D09)              | 07/85 → 05/91   |  | 951 606   | 920 752   |

## MODELL/MODEL/MODELE



































## BEMERKUNGEN/REMARKS/ REMARQUES





|                                     |               |            |         |         |
|-------------------------------------|---------------|------------|---------|---------|
| Space Wagon 1.8 Turbo Diesel (N38W) | 10/91 → 10/98 | ABS        | 951 604 | 952 415 |
| Space Wagon 1.8 Turbo Diesel (N38W) | 10/91 → 10/98 | ABS        | 951 604 | 952 417 |
| Space Wagon 2.0 (D08)               | 86 → 05/91    | ABS        | 951 604 | 952 415 |
| Space Wagon 2.0 (N33W)              | 06/92 → 10/98 | ABS        | 951 604 | 952 415 |
| Space Wagon 2.0 (N33W)              | 06/92 → 10/98 | ABS        | 951 604 | 952 417 |
| Space Wagon 2.0 (N38W)              | 06/92 → 10/98 | ABS        | 951 604 | 952 415 |
| Space Wagon 2.0 (N38W)              | 06/92 → 10/98 | ABS        | 951 604 | 952 417 |
| Space Wagon 2.0 Turbo Diesel (N38W) | 06/92 → 10/98 | ABS        | 951 604 | 952 415 |
| Space Wagon 2.0 Turbo Diesel (N38W) | 06/92 → 10/98 | ABS        | 951 604 | 952 417 |
| Space Wagon 2.0 4WD (D08)           | 02/85 → 05/91 |            | 951 449 | 952 993 |
| Space Wagon 2.0 4WD (N43W)          | 06/91 → 10/98 |            | 951 604 | 952 993 |
| Space Wagon 2.4i (N43W)             | 10/91 → 10/98 | ABS {Rear} | 951 604 | 952 415 |
| Space Wagon 2.4i (N43W)             | 10/91 → 10/98 | ABS        | 951 604 | 952 417 |
| Space Wagon 2.4 GDI (N5_W)          | 10/98 → 02    |            | 951 604 | -       |
| Space Wagon 2.4 GDI 4WD (N5_W)      | 10/98 → 02    |            | 951 604 | -       |
| Starion 2.0i Turbo (A183)           | 82 → 90       |            | 951 756 | 952 679 |
| Starion 2.6i Turbo (A187)           | 86 → 90       |            | 951 756 | -       |
| Tredia (A211A, A212A)               | 82 → 90       |            | 951 606 | 920 752 |
| Tredia (A213A, A214A, A215A)        | 84 → 90       |            | 951 606 | 920 752 |
| Tredia 4WD (A215G)                  | 85 → 90       |            | 951 449 | 952 993 |
| L 200 1.6 (K01T, K11T)              | 86 → 06/90    |            | 951 708 | 952 661 |
| L 200 1.6 (K01T, K11T)              | 07/90 → 06/96 |            | 951 708 | 952 936 |
| L 200 2.0 (K02T, K12T)              | 86 → 06/90    |            | 951 708 | 952 661 |
| L 200 2.0 (K02T, K12T)              | 07/90 → 06/96 |            | 951 708 | 952 936 |
| L 200 2.4 (K15T)                    | 86 → 06/90    |            | 951 708 | 952 661 |
| L 200 2.4 (K15T)                    | 07/90 → 06/96 |            | 951 708 | 952 936 |
| L 200 2.5 Diesel (K04T, K14T)       | 86 → 06/90    |            | 951 708 | 952 661 |
| L 200 2.5 Diesel (K04T, K14T)       | 07/90 → 06/96 |            | 951 708 | 952 936 |
| L 200 2.5 Diesel (K64T)             | 97 → 02       |            | 951 284 | 952 297 |
| L 200 2.5 Turbo Diesel (K74T)       | 01 → 02       |            | 951 284 | 952 297 |
| L 200 2.6 (K03T, K13T)              | 86 → 06/90    |            | 951 708 | 952 661 |
| L 200 2.6 (K03T, K13T)              | 07/90 → 06/96 |            | 951 708 | 952 936 |
| L 200 4WD 2.0 (K22T, K32T)          | 86 → 06/90    |            | 951 722 | 952 661 |
| L 200 4WD 2.0 (K22T, K32T)          | 07/90 → 06/96 |            | 951 722 | 952 936 |
| L 200 4WD 2.4 (K35T)                | 06/93 → 06/96 |            | 951 722 | 952 936 |
| L 200 4WD 2.5 Diesel (K24T, K34T)   | 86 → 06/90    |            | 951 722 | 952 661 |
| L 200 4WD 2.5 Diesel (K24T, K34T)   | 07/90 → 06/96 |            | 951 722 | 952 936 |
| L 200 4WD 2.5 Turbo Diesel (K74T)   | 97 → 02       |            | 951 284 | 952 297 |
| L 300 1.6 (L032P, P02V, P12V)       | 11/86 → 10/90 |            | 951 708 | 952 758 |
| L 300 1.6 (L032P, P02V, P12V)       | 11/90 → 06/96 |            | 951 708 | 952 935 |
| L 300 2.0 (P03V, P03W, P13V)        | 11/86 → 10/90 |            | 951 708 | 952 758 |
| L 300 2.0 (P03V, P03W, P13V)        | 11/90 → 06/96 |            | 951 708 | 952 935 |
| L 300 2.0 (P03W, P15T)              | 06/96 → 00    |            | 951 708 | 952 661 |
| L 300 2.4 (P04V, P04W, P14V)        | 11/86 → 10/90 |            | 951 708 | 952 758 |
| L 300 2.4 (P04V, P04W, P14V)        | 11/90 → 06/96 |            | 951 708 | 952 935 |
| L 300 2.5 Diesel (L039P)            | 11/86 → 10/90 |            | 951 708 | 952 758 |
| L 300 2.5 Diesel (L039P)            | 11/90 → 06/96 |            | 951 708 | 952 935 |
| L 300 2.5 Diesel (P05V, P05W, P15V) | 11/86 → 10/90 |            | 951 708 | 952 758 |
| L 300 2.5 Diesel (P05V, P05W, P15V) | 11/90 → 06/96 |            | 951 708 | 952 935 |
| L 300 2.5 Diesel (P15T)             | 11/94 → 00    |            | 951 708 | 952 661 |
| L 300 4WD 1.8 (L035)                | 11/86 → 10/90 |            | 951 722 | 952 661 |
| L 300 4WD 1.8 (L035)                | 11/90 → 06/96 |            | 951 722 | 952 661 |
| L 300 4WD 2.0 (L037, P23V/W)        | 11/86 → 10/90 |            | 951 722 | 952 661 |
| L 300 4WD 2.0 (L037, P23V/W)        | 11/90 → 06/96 |            | 951 722 | 952 936 |



| MODELL/MODEL/MODELE    |                |  | BEMERKUNGEN/REMARKS/<br>REMARQUES   |  |  |  |
|------------------------|----------------|---|---|--|---|---|
| L 300 4WD 2.4          | (P24V, P24W)   | 11/86 → 10/90   |  |  | 951 722   | 952 661   |
| L 300 4WD 2.4          | (P24V, P24W)   | 11/90 → 06/96   |  |  | 951 722   | 952 936   |
| L 300 4WD 2.5 Diesel   | (P25V/W, P45V) | 11/86 → 10/90   |  |  | 951 722   | 952 661   |
| L 300 4WD 2.5 Diesel   | (P25V/W, P45V) | 11/90 → 06/96   |  |  | 951 722   | 952 936   |
| L 400 2.5 Turbo Diesel | (PA5W/V)       | 95 → 02   |  |  | -   | 952 661   |

| MODELL/MODEL/MODELE    |        | BEMERKUNGEN/REMARKS/<br>REMARQUES |   |  |         |
|------------------------|--------|-----------------------------------|---|---|---------|
| 100 NX 1.6i 16V        | (B13)  | 10/91 → 98                        | ABS   | 961 648   | 962 712 |
| 100 NX 1.6i 16V        | (B13)  | 10/91 → 98                        | ABS   | 961 648   | 962 714 |
| 100 NX 2.0i 16V GTI    | (B13)  | 10/91 → 98                        |   | 961 648   | 962 714 |
| 200 SX 1.8i 16V Turbo  | (S13)  | 09/88 → 93                        |   | 961 759   | 961 751 |
| 200 SX 2.0             | (S12)  | 10/83 → 11/84                     |    | -   | 962 684 |
| 200 SX 2.0i 16V Turbo  | (S14)  | 09/94 → 95                        |   | 961 964   | 961 751 |
| 280 ZX 2.7             | (S130) | 79 → 84                           |   | 961 503   | -       |
| 300 ZX 3.0i 24V Turbo  | (Z32)  | 90 → 95                           |    | 961 753   | 962 757 |
| 300 ZX 3.0i 24V Turbo  | (Z32)  | 90 → 95                           |    | 961 753   | 962 755 |
| 350 Z                  | (Z33)  | 03 → 05                           |   | 961 828   | -       |
| Almera I 1.4i 16V      | (N15)  | 07/95 → 07/00                     | ABS   | 961 648   | 962 712 |
| Almera I 1.4i 16V      | (N15)  | 07/95 → 07/00                     | ABS   | 961 648   | 962 241 |
| Almera I 1.6i 16V      | (N15)  | 07/95 → 07/00                     | ABS   | 961 648   | 962 712 |
| Almera I 1.6i 16V      | (N15)  | 07/95 → 07/00                     | ABS   | 961 648   | 962 241 |
| Almera I 2.0i 16V GTI  | (N15)  | 07/95 → 07/00                     | ABS   | 961 648   | 962 712 |
| Almera I 2.0i 16V GTI  | (N15)  | 07/95 → 07/00                     | ABS   | 961 648   | 962 241 |
| Almera I 2.0 Diesel    | (N15)  | 07/95 → 07/00                     | ABS   | 961 648   | 962 712 |
| Almera I 2.0 Diesel    | (N15)  | 07/95 → 07/00                     | ABS   | 961 648   | 962 241 |
| Almera II 1.5 16V      | (N16)  | 01/00 → 04                        |   | 961 229   | -       |
| Almera II 1.5 dCi      | (N16)  | 01/03 → 04                        |   | 961 229   | -       |
| Almera II 1.8 16V      | (N16)  | 01/00 → 04                        |   | 961 229   | -       |
| Almera II 2.2 Di       | (N16)  | 01/00 → 04                        |   | 961 229   | -       |
| Almera II 2.2 dCi      | (N16)  | 09/03 → 04                        |   | 961 229   | -       |
| Almera Tino 1.8i 16V   | (V10)  | 08/00 → 04                        |   | 961 900   | 962 903 |
| Almera Tino 2.0i 16V   | (V10)  | 08/00 → 04                        |   | 961 900   | 962 903 |
| Almera Tino 2.2 Di     | (V10)  | 08/00 → 04                        |   | 961 900   | 962 903 |
| Almera Tino 2.2 dCi    | (V10)  | 09/03 → 04                        |   | 961 900   | 962 903 |
| Bluebird               | (910)  | 80 → 05/84                        |    | -   | 962 684 |
| Bluebird               | (U11)  | 11/83 → 90                        |    | 961 576   | 962 760 |
| Bluebird               | (U11)  | 11/83 → 90                        |   | 961 576   | 962 762 |
| Bluebird               | (U11)  | 11/83 → 90                        |   | 961 576   | 962 760 |
| Bluebird Turbo         | (U11)  | 11/83 → 90                        |    | 961 576   | 962 760 |
| Bluebird               | (U12)  | 07/89 → 90                        |   | 960 638   | 962 810 |
| Bluebird               | (T12)  | 12/85 → 89                        |    | 961 576   | 962 760 |
| Bluebird               | (T12)  | 12/85 → 89                        |   | 961 576   | 962 762 |
| Bluebird               | (T12)  | 12/85 → 89                        |   | 961 576   | 962 760 |
| Bluebird Turbo         | (T12)  | 12/85 → 89                        |    | 961 576   | 962 760 |
| Bluebird               | (T12)  | 90 → 02/92                        |   | 961 576   | 962 760 |
| Bluebird 2.4           | (U13)  | 06/92 → 05/93                     | ABS   | 960 638   | 962 810 |
| Bluebird 2.4           | (U13)  | 06/92 → 05/93                     | ABS   | 960 638   | -       |
| Cherry 140 A           | (N10)  | 81 → 81                           |   | 961 680   | 962 776 |
| Cherry 1.0, 1.3        | (N10)  | 82 → 82                           |   | 961 796   | 962 776 |
| Cherry 1.0, 1.3        | (N12)  | 82 → 87                           |   | 961 796   | 962 776 |
| Cherry 1.5             | (N10)  | 82 → 82                           |   | 961 680   | 962 776 |
| Cherry 1.5, 1.6, 1.7 D | (N12)  | 82 → 87                           |   | 961 680   | 962 776 |
| Laurel                 | (C31)  | 81 → 85                           |    | -   | 962 684 |
| Laurel                 | (C32)  | 86 → 90                           |   | -   | 962 286 |
| Liberta                | (T12)  | 12/85 → 89                        |    | 961 576   | 962 760 |
| Liberta                | (T12)  | 12/85 → 89                        |   | 961 576   | 962 762 |
| Liberta                | (T12)  | 12/85 → 89                        |   | 961 576   | 962 760 |
| Liberta Turbo          | (T12)  | 12/85 → 89                        |    | 961 576   | 962 760 |
| March 1.0, 1.2         | (K10)  | 83 → 10/88                        |   | 961 796   | 962 682 |
| March 1.0, 1.2         | (K10)  | 11/88 → 92                        |   | 961 610   | 962 548 |
| March 1.0i 16V         | (K11)  | 92 → 02/03                        | ABS   | 961 479   | 962 548 |



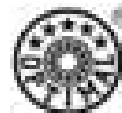











| MODELL/MODEL/MODELE    |        |  | BEMERKUNGEN/REMARKS/<br>REMARQUES |  |  |  |
|------------------------|--------|---|-----------------------------------|--|---|---|
| March 1.0i 16V         | (K11)  | 92 → 02/03  | ABS                               |  | 961 479   | 962 481   |
| March 1.2i 16V         | (K12)  | 01/03 → 05  | ABS - Active Sensor Bearing       |  | 701 977   | 702 312   |
| March 1.3i 16V         | (K11)  | 92 → 10/00  | <del>ABS</del>                    |  | 961 479   | 962 548   |
| March 1.3i 16V         | (K11)  | 92 → 10/00  | ABS                               |  | 961 479   | 962 481   |
| March 1.4i 16V         | (K11)  | 10/00 → 02/03   | <del>ABS</del>                    |  | 961 479   | 962 548   |
| March 1.4i 16V         | (K11)  | 10/00 → 02/03   | ABS                               |  | 961 479   | 962 481   |
| March 1.4i 16V         | (K12)  | 01/03 → 05  | ABS - Active Sensor Bearing       |  | 701 977   | 702 312   |
| March 1.5 Diesel       | (K11)  | 98 → 02/03  | <del>ABS</del>                    |  | 961 479   | 962 548   |
| March 1.5 Diesel       | (K11)  | 98 → 02/03  | ABS                               |  | 961 479   | 962 481   |
| March 1.5 dCi          | (K12)  | 01/03 → 05  | ABS - Active Sensor Bearing       |  | 701 977   | 702 312   |
| Maxima I 3.0i V6 12V   | (J30)  | 12/88 → 06/94   | <del>ABS</del>                    |  | 960 638   | 962 853   |
| Maxima I 3.0i V6 12V   | (J30)  | 12/88 → 06/94   | ABS                               |  | 960 638   | 962 779   |
| Maxima II 2.0i V6 24V  | (A32)  | 07/94 → 08/00   | <del>ABS</del>                    |  | 960 638   | 962 853   |
| Maxima II 2.0i V6 24V  | (A32)  | 07/94 → 08/00   | ABS                               |  | 960 638   | 962 807   |
| Maxima II 2.5i V6 24V  | (A32)  | 07/94 → 08/00   | <del>ABS</del>                    |  | 960 638   | 962 853   |
| Maxima II 2.5i V6 24V  | (A32)  | 07/94 → 08/00   | ABS                               |  | 960 638   | 962 807   |
| Maxima II 3.0i V6 24V  | (A32)  | 07/94 → 08/00   | <del>ABS</del>                    |  | 960 638   | 962 853   |
| Maxima II 3.0i V6 24V  | (A32)  | 07/94 → 08/00   | ABS                               |  | 960 638   | 962 807   |
| Maxima III 2.0i V6 24V | (A33)  | 03/00 → 04  |                                   |  | 961 900   | 962 903   |
| Maxima III 2.5i V6 24V | (A33)  | 03/00 → 04  |                                   |  | 961 900   | 962 903   |
| Maxima III 3.0i V6 24V | (A33)  | 03/00 → 04  |                                   |  | 961 900   | 962 903   |
| Murano 3.5 4x4         | (Z50)  | 03/05 → 06  |                                   |  | 961 819   | 962 823   |
| Micra 1.0, 1.2         | (K10)  | 83 → 10/88  |                                   |  | 961 796   | 962 682   |
| Micra 1.0, 1.2         | (K10)  | 11/88 → 92  |                                   |  | 961 610   | 962 548   |
| Micra 1.0i 16V         | (K11)  | 92 → 02/03  | <del>ABS</del>                    |  | 961 479   | 962 548   |
| Micra 1.0i 16V         | (K11)  | 92 → 02/03  | ABS                               |  | 961 479   | 962 481   |
| Micra 1.2i 16V         | (K12)  | 01/03 → 05  | ABS - Active Sensor Bearing       |  | 701 977   | 702 312   |
| Micra 1.3i 16V         | (K11)  | 92 → 10/00  | <del>ABS</del>                    |  | 961 479   | 962 548   |
| Micra 1.3i 16V         | (K11)  | 92 → 10/00  | ABS                               |  | 961 479   | 962 481   |
| Micra 1.4i 16V         | (K11)  | 10/00 → 02/03   | <del>ABS</del>                    |  | 961 479   | 962 548   |
| Micra 1.4i 16V         | (K11)  | 10/00 → 02/03   | ABS                               |  | 961 479   | 962 481   |
| Micra 1.4i 16V         | (K12)  | 01/03 → 05  | ABS - Active Sensor Bearing       |  | 701 977   | 702 312   |
| Micra 1.5 Diesel       | (K11)  | 98 → 02/03  | <del>ABS</del>                    |  | 961 479   | 962 548   |
| Micra 1.5 Diesel       | (K11)  | 98 → 02/03  | ABS                               |  | 961 479   | 962 481   |
| Micra 1.5 dCi          | (K12)  | 01/03 → 05  | ABS - Active Sensor Bearing       |  | 701 977   | 702 312   |
| Note 1.4, 1.5 dCi, 1.6 | (E11)  | 03/06 → 12/06   |                                   |  | 701 977   | 702 312   |
| Prairie 1.5            | (M10)  | 82 → 88   |                                   |  | 961 680   | 962 776   |
| Prairie 1.8            | (M10)  | 83 → 88   |                                   |  | 961 680   | 962 776   |
| Prairie 2.0i           | (M10)  | 83 → 09/88  |                                   |  | 961 680   | 962 776   |
| Prairie 2.0i 4WD       | (M10)  | 86 → 06/88  |                                   |  | 960 702   | 960 702   |
| Prairie Pro 2.0i       | (M11)  | 10/88 → 94  |                                   |  | 960 638   | 962 810   |
| Prairie Pro 2.0i 4WD   | (M11)  | 10/88 → 94  |                                   |  | 960 638   | 960 638   |
| Prairie Pro 2.4i       | (M11)  | 92 → 94   |                                   |  | 960 638   | 962 810   |
| Prairie Pro 2.4i 4WD   | (M11)  | 92 → 94   |                                   |  | 960 638   | 960 638   |
| Presea 1.5i            | (R10)  | 05/91 → 96  | <del>ABS</del>                    |  | 961 648   | 962 712   |
| Presea 1.5i            | (R10)  | 05/91 → 96  | ABS                               |  | 961 648   | 962 714   |
| Presea 2.0i            | (R10)  | 05/91 → 96  | <del>ABS</del>                    |  | 961 648   | 962 712   |
| Presea 2.0i            | (R10)  | 05/91 → 96  | ABS                               |  | 961 648   | 962 714   |
| Primera 1.6i 16V       | (P10E) | 06/90 → 06/96   | <del>ABS</del>                    |  | 960 638   | 962 703   |
| Primera 1.6i 16V       | (P10E) | 06/90 → 06/96   | ABS                               |  | 960 638   | 962 705   |
| Primera 1.6i 16V       | (P11E) | 07/96 → 02  |                                   |  | 960 638   | 962 986   |
| Primera 1.6i 16V       | (P12)  | 03/02 → 05  |                                   |  | 961 900   | 962 873   |
| Primera 1.8i 16V       | (P11E) | 07/99 → 02  |                                   |  | 960 638   | 962 986   |
| Primera 1.8i 16V       | (P12)  | 03/02 → 05  |                                   |  | 961 900   | 962 873   |

















































































## BEMERKUNGEN/REMARKS/ REMARQUES













| MODELL/MODEL/MODELE            |            |       |   |       |     |                 |
|--------------------------------|------------|-------|---|-------|-----|-----------------|
| Primera 1.9 dCi                | (P12)      | 04/03 | → | 05    |     | 961 900 962 873 |
| Primera 2.0i 16V               | (P10E)     | 06/90 | → | 06/96 | ABS | 960 638 962 703 |
| Primera 2.0i 16V               | (P10E)     | 06/90 | → | 06/96 | ABS | 960 638 962 705 |
| Primera 2.0i 16V               | (P11E)     | 07/96 | → | 02    |     | 960 638 962 986 |
| Primera 2.0i 16V               | (P12)      | 03/02 | → | 05    |     | 961 900 962 873 |
| Primera 2.0 Diesel             | (P10E)     | 06/90 | → | 06/96 | ABS | 960 638 962 703 |
| Primera 2.0 Diesel             | (P10E)     | 06/90 | → | 06/96 | ABS | 960 638 962 705 |
| Primera 2.0 Turbo Diesel       | (P11E)     | 07/96 | → | 02    |     | 960 638 962 986 |
| Primera 2.2 Di                 | (P12)      | 03/02 | → | 05    |     | 961 900 962 873 |
| Primera 2.2 dCi                | (P12)      | 04/03 | → | 05    |     | 961 900 962 873 |
| Primera 4WD                    | (P10E)     | 04/91 | → | 09/94 | ABS | 961 701 960 638 |
| Primera 4WD                    | (P10E)     | 04/91 | → | 09/94 | ABS | 961 701 -       |
| Primera Wagon 1.6i 16V         | (W10)      | 06/90 | → | 97    | ABS | 960 702 962 810 |
| Primera Wagon 1.6i 16V         | (W10)      | 06/90 | → | 97    | ABS | 960 702 962 981 |
| Primera Wagon 1.6i 16V         | (WP11E)    | 98    | → | 02    |     | 960 638 962 986 |
| Primera Wagon 1.8i 16V         | (WP12)     | 03/02 | → | 04    |     | 961 900 962 873 |
| Primera Wagon 2.0i 16V         | (W10)      | 06/90 | → | 97    | ABS | 960 702 962 810 |
| Primera Wagon 2.0i 16V         | (W10)      | 06/90 | → | 97    | ABS | 960 702 962 981 |
| Primera Wagon 2.0i 16V         | (WP11E)    | 98    | → | 02    |     | 960 638 962 986 |
| Primera Wagon 2.0i 16V         | (WP12)     | 03/02 | → | 04    |     | 961 900 962 873 |
| Primera Wagon 2.0 Diesel       | (W10)      | 06/90 | → | 97    | ABS | 960 702 962 810 |
| Primera Wagon 2.0 Diesel       | (W10)      | 06/90 | → | 97    | ABS | 960 702 962 981 |
| Primera Wagon 2.0 Turbo Diesel | (WP11E)    | 98    | → | 02    |     | 960 638 962 986 |
| Primera Wagon 2.2 Di           | (WP12)     | 03/02 | → | 04    |     | 961 900 962 873 |
| Pulsar                         | (N10)      | 08/78 | → | 01/82 |     | 961 680 962 776 |
| Pulsar 1.0, 1.3                | (N12)      | 82    | → | 85    |     | 961 796 962 776 |
| Pulsar 1.3, 1.4                | (B12, N13) | 86    | → | 90    |     | 960 578 962 718 |
| Pulsar 1.4                     | (N14)      | 10/90 | → | 03/93 | ABS | 961 648 962 712 |
| Pulsar 1.4                     | (N14)      | 10/90 | → | 03/93 | ABS | 961 648 962 714 |
| Pulsar 1.4                     | (N15)      | 07/95 | → | 00    | ABS | 961 648 962 712 |
| Pulsar 1.4                     | (N15)      | 07/95 | → | 00    | ABS | 961 648 -       |
| Pulsar 1.5 Turbo               | (N12)      | 82    | → | 85    |     | 961 680 962 776 |
| Pulsar 1.6                     | (B12, N13) | 86    | → | 90    |     | 960 578 962 718 |
| Pulsar 1.6i 16V DOHC           | (B12, N13) | 86    | → | 90    |     | 960 578 962 716 |
| Pulsar 1.6                     | (N14)      | 10/90 | → | 03/93 | ABS | 961 648 962 712 |
| Pulsar 1.6                     | (N14)      | 10/90 | → | 03/93 | ABS | 961 648 962 714 |
| Pulsar 1.6                     | (N15)      | 07/95 | → | 00    | ABS | 961 648 962 712 |
| Pulsar 1.6                     | (N15)      | 07/95 | → | 00    | ABS | 961 648 -       |
| Pulsar 1.7 Diesel              | (N12)      | 82    | → | 85    |     | 961 680 962 776 |
| Pulsar 1.7 Diesel              | (B12, N13) | 86    | → | 90    |     | 960 578 962 718 |
| Pulsar 1.8i 16V DOHC           | (B12, N13) | 86    | → | 90    |     | 960 578 962 716 |
| Pulsar 2.0                     | (N14)      | 10/90 | → | 03/93 | ABS | 961 648 962 712 |
| Pulsar 2.0                     | (N14)      | 10/90 | → | 03/93 | ABS | 961 648 962 714 |
| Pulsar 2.0                     | (N15)      | 07/95 | → | 00    | ABS | 961 648 962 712 |
| Pulsar 2.0                     | (N15)      | 07/95 | → | 00    | ABS | 961 648 -       |
| Pulsar 4WD                     | (N13)      | 86    | → | 90    |     | 960 578 960 702 |
| Pulsar 4WD                     | (N14)      | 10/90 | → | 03/93 |     | 961 648 961 648 |
| Sentra 1.3                     | (B14)      | 01/94 | → | 09/98 | ABS | 961 648 962 712 |
| Sentra 1.4                     | (B14)      | 01/94 | → | 09/98 | ABS | 961 648 962 712 |
| Sentra 1.5                     | (B14)      | 01/94 | → | 09/98 | ABS | 961 648 962 712 |
| Sentra 1.5                     | (B14)      | 01/94 | → | 09/98 | ABS | 961 648 -       |
| Sentra 1.6                     | (B13)      | 09/90 | → | 12/93 | ABS | 961 648 962 712 |
| Sentra 1.6                     | (B13)      | 09/90 | → | 12/93 | ABS | 961 648 962 714 |
| Sentra 1.6                     | (B14)      | 01/94 | → | 09/98 | ABS | 961 648 962 712 |

| MODELL/MODEL/MODELE     |            |  | BEMERKUNGEN/REMARKS/<br>REMARQUES   |  |  |  |
|-------------------------|------------|---|---|--|---|---|
| Sentra 1.6              | (B14)      | 01/94 → 09/98   | ABS   |  | 961 648   | -   |
| Sentra 2.0              | (B13)      | 09/90 → 12/93   | <del>ABS</del>  |  | 961 648   | 962 712   |
| Sentra 2.0              | (B13)      | 09/90 → 12/93   | ABS   |  | 961 648   | 962 714   |
| Sentra 2.0 Diesel       | (B14)      | 01/94 → 09/98   | <del>ABS</del>  |  | 961 648   | 962 712   |
| Sentra 2.0 Diesel       | (B14)      | 01/94 → 09/98   | ABS   |  | 961 648   | -   |
| Sentra 4WD              | (B12)      | 86 → 90   |   |  | 960 578   | 960 702   |
| Silvia                  |            | 80 → 83   |   |  | 961 503   | 962 684   |
| Silvia                  |            | 84 → 89   |    |  | -   | 962 684   |
| Stanza                  | (T11)      | 82 → 11/85  |   |  | -   | 962 760   |
| Stanza                  | (T12)      | 12/85 → 89  |    |  | 961 576   | 962 760   |
| Stanza                  | (T12)      | 12/85 → 89  |   |  | 961 576   | 962 762   |
| Stanza                  | (T12)      | 12/85 → 89  |   |  | 961 576   | 962 760   |
| Stanza Turbo            | (T12)      | 12/85 → 89  |    |  | 961 576   | 962 760   |
| Stanza                  | (T12)      | 90 → 92   |   |  | 961 576   | 962 760   |
| Sunny 1.3               | (B11)      | 82 → 85   |    |  | 961 796   | 962 776   |
| Sunny 1.3               | (B12, N13) | 86 → 89   |   |  | 960 578   | 962 718   |
| Sunny 1.3               | (B14)      | 04/94 → 96  | <del>ABS</del>  |  | 961 648   | 962 712   |
| Sunny 1.4               | (B12, N13) | 86 → 89   |   |  | 960 578   | 962 718   |
| Sunny 1.4i 16V          | (N14)      | 10/90 → 96  | <del>ABS</del>  |  | 961 648   | 962 712   |
| Sunny 1.4i 16V          | (N14)      | 10/90 → 96  | ABS   |  | 961 648   | 962 714   |
| Sunny 1.4i 16V          | (B14)      | 04/94 → 96  | <del>ABS</del>  |  | 961 648   | 962 712   |
| Sunny 1.5               | (B11)      | 82 → 85   |    |  | 961 680   | 962 776   |
| Sunny 1.5               | (B12, N13) | 86 → 89   |   |  | 960 578   | 962 718   |
| Sunny 1.5               | (B14)      | 04/94 → 96  | <del>ABS</del>  |  | 961 648   | 962 712   |
| Sunny 1.5               | (B14)      | 04/94 → 96  | ABS   |  | 961 648   | -   |
| Sunny 1.6               | (B11)      | 82 → 85   |    |  | 961 680   | 962 776   |
| Sunny 1.6               | (B12, N13) | 86 → 89   |   |  | 960 578   | 962 718   |
| Sunny 1.6i 16V GTI      | (B12, N13) | 86 → 90   |   |  | 960 578   | 962 716   |
| Sunny 1.6               | (B13)      | 09/90 → 10/94   | <del>ABS</del>  |  | 961 648   | 962 712   |
| Sunny 1.6               | (B13)      | 09/90 → 10/94   | ABS   |  | 961 648   | 962 714   |
| Sunny 1.6i 16V          | (N14)      | 10/90 → 96  | <del>ABS</del>  |  | 961 648   | 962 712   |
| Sunny 1.6i 16V          | (N14)      | 10/90 → 96  | ABS   |  | 961 648   | 962 714   |
| Sunny 1.6i 16V          | (B14)      | 04/94 → 96  | <del>ABS</del>  |  | 961 648   | 962 712   |
| Sunny 1.6i 16V          | (B14)      | 04/94 → 96  | ABS   |  | 961 648   | -   |
| Sunny 1.7 Diesel        | (B12, N13) | 86 → 90   |   |  | 960 578   | 962 718   |
| Sunny 1.8i 16V GTI      | (B12, N13) | 86 → 90   |   |  | 960 578   | 962 716   |
| Sunny 2.0               | (B13)      | 09/90 → 10/94   | <del>ABS</del>  |  | 961 648   | 962 712   |
| Sunny 2.0               | (B13)      | 09/90 → 10/94   | ABS   |  | 961 648   | 962 714   |
| Sunny 2.0i 16V          | (N14)      | 10/90 → 96  | <del>ABS</del>  |  | 961 648   | 962 712   |
| Sunny 2.0i 16V          | (N14)      | 10/90 → 96  | ABS   |  | 961 648   | 962 714   |
| Sunny 2.0i 16V GTI      | (N14)      | 10/90 → 96  | ABS   |  | 961 648   | 962 714   |
| Sunny 2.0 Diesel        | (B14)      | 04/94 → 96  |   |  | 961 648   | 962 712   |
| Sunny 2.0 Diesel        | (N14)      | 10/90 → 96  | <del>ABS</del>  |  | 961 648   | 962 712   |
| Sunny 2.0 Diesel        | (N14)      | 10/90 → 96  | ABS   |  | 961 648   | 962 714   |
| Sunny 4WD 1.6           | (B12, N13) | 86 → 90   |   |  | 960 578   | 960 702   |
| Sunny 4WD 1.6 16V       | (N14)      | 10/90 → 96  |   |  | 961 648   | 961 648   |
| Sunny 4WD 2.0i 16V GT R | (N14)      | 10/90 → 96  |   |  | 961 648   | 961 648   |
| Sunny Wagon             | (Y10)      | 11/90 → 96  |   |  | 961 648   | -   |
| X-Trail 2.0i 16V 4x4    | (T30)      | 07/01 → 04  |   |  | 961 900   | 962 897   |
| X-Trail 2.2 dCi 4x4     | (T30)      | 07/01 → 04  |   |  | 961 900   | 962 897   |
| X-Trail 2.5i 16V 4x4    | (T30)      | 01/03 → 04  |   |  | 961 900   | 962 897   |
| Z 350                   |            | 01/03 → 04  |   |  | -   | 962 824   |
| Atlas Cabstar           | (F22)      | 01/82 → 10/88   |    |  | 961 808   | 962 686   |
| Atlas Cabstar           | (F22)      | 11/88 → 89  |    |  | 961 808   | -   |















| MODELL/MODEL/MODELE                    |  | BEMERKUNGEN/REMARKS/<br>REMARQUES   |  |  |  |
|--|---|---|--|---|---|
| Interstar                              | 02 → 04   |    |  | 701 860   | 702 846   |
| King Cab (720)                         | 80 → 85   |    |  | 961 808   | 962 686   |
| King Cab (D21)                         | 09/85 → 92  |    |  | 961 801   | 962 435   |
| King Cab 4WD (D21)                     | 09/85 → 92  |    |     | 961 801   | 962 435   |
| King Cab 4WD (D21)                     | 11/85 → 89  |    |  HD | 961 801   | 962 847   |
| Pathfinder (D21)                       | 08/87 → 93  |    |  | 961 801   | 962 435   |
| Pathfinder 3.3 V6 (R50)                | 97 → 00   |    |  | 961 801   | -   |
| Pathfinder 3.5 V6 (R50)                | 97 → 00   |    |  | 961 801   | -   |
| Patrol (160)                           | 11/79 → 07/83   |    |     | 961 904   | -   |
| Patrol (160)                           | 11/79 → 08/88   |    | HD   | 961 904   | 962 905   |
| Patrol (160)                           | 07/84 → 08/88   |    | Full-floating axle   | 961 904   | -   |
| Patrol GR I 2.8 Turbo Diesel (Y60)     | 08/88 → 05/97   |    |  | 961 411   | 962 841   |
| Patrol GR I 2.8 Turbo Diesel 4WD (Y60) | 08/88 → 05/97   |    |  | 961 411   | 962 413   |
| Patrol GR I 4.2i 4WD (Y60)             | 10/91 → 05/97   |    |  | 961 411   | 962 413   |
| Patrol GR I 4.2 Diesel 4WD (Y60)       | 10/91 → 05/97   |    |  | 961 411   | 962 413   |
| Patrol GR I 4.2 Turbo Diesel 4WD (Y60) | 10/91 → 05/97   |    |  | 961 411   | 962 413   |
| Patrol GR II 2.8 TDI (Y61)             | 10/97 → 05/99   |    |  | 961 965   | 962 413   |
| Patrol GR II 2.8 TDI (Y61)             | 06/99 → 04  |    |  | 961 965   | 962 413   |
| Patrol GR II 3.0 TDI 16V (Y61)         | 02/00 → 04  |    |  | 961 965   | 962 413   |
| Patrol GR II 4.5i (Y61)                | 10/97 → 04  |    |  | 961 965   | 962 413   |
| Pick Up (D22)                          | 98 → 04   |    |  | 961 801   | 962 435   |
| Pick Up 4WD (D22)                      | 98 → 04   |    |  | 961 801   | 962 985   |
| Primaster                              | 01 → 03   |   | ABS  | 201 085   | 202 101   |
| Primaster                              | 01 → 03   |  | ABS - Active Sensor Bearing  | 201 089   | 202 101   |
| Safari (160)                           | 11/79 → 07/83   |  |   | 961 904   | -   |
| Safari (160)                           | 11/79 → 08/88   |  | HD   | 961 904   | 962 905   |
| Safari (160)                           | 07/84 → 08/88   |  | Full-floating axle   | 961 904   | -   |
| Safari 2.8 Turbo Diesel 2WD (Y60)      | 08/88 → 01/94   |  |  | 961 411   | 962 841   |
| Safari 2.8 Turbo Diesel 4WD (Y60)      | 08/88 → 01/94   |  |  | 961 411   | 962 413   |
| Safari 4.2 KAT 4WD (Y60)               | 10/91 → 01/94   |  |  | 961 411   | 962 413   |
| Safari 4.2 Diesel 4WD (Y60)            | 10/91 → 01/94   |  |  | 961 411   | 962 413   |
| Serena 1.6 16V (C23M)                  | 08/93 → 00  |  |  | 961 753   | 962 949   |
| Serena 2.0 16V DOHC (C23M)             | 10/92 → 04/96   |  |  | 961 753   | 962 949   |
| Serena 2.0 16V DOHC (C23M)             | 05/96 → 00  |  |  | 961 753   | 962 984   |
| Serena 2.0 Diesel (C23M)               | 11/92 → 00  |  |  | 961 753   | 962 949   |
| Serena 2.3 Diesel (C23M)               | 01/95 → 00  |  |  | 961 753   | 962 949   |
| Terrano I 2.4i (WD21)                  | 08/87 → 94  |  |  | 961 801   | 962 435   |
| Terrano I 2.7 D, 2.7 TD (WD21)         | 08/87 → 94  |  |  | 961 801   | 962 435   |
| Terrano I 3.0i (WD21)                  | 08/87 → 94  |  |  | 961 801   | 962 435   |
| Terrano II 2.4i (R20)                  | 08/93 → 04  |  |  | 961 801   | 962 985   |
| Terrano II 2.7 TD, 2.7 Tdi (R20)       | 08/93 → 04  |  |  | 961 801   | 962 985   |
| Terrano II 3.0 Di (R20)                | 02 → 04   |  |  | 961 801   | 962 985   |
| Urvan (E21)                            | 82 → 87   |  |  | 961 808   | 962 686   |
| Urvan (E23)                            | 82 → 05/87  |  |  | 961 808   | 962 686   |
| Urvan (E24)                            | 05/87 → 04/94   |  |  | 961 677   | 962 435   |
| Vanette 1.5 (C22)                      | 87 → 95   |  |  | 961 724   | 962 684   |
| Vanette 2.0 Diesel (C22)               | 09/86 → 95  |  |  | 961 724   | 962 684   |
| Vanette 2.0 Diesel (C22)               | 07/91 → 95  |  |  | 961 724   | -   |
| Vanette 2.3 Diesel (C23M)              | 07/92 → 95  |  |  | 961 724   | 962 684   |
| Vanette Cargo 2.0 D (C23)              | 96 → 00   |  |  | 961 753   | 962 985   |
| Vanette Cargo 1.6 16V (C23)            | 96 → 00   |  |  | 961 753   | 962 985   |
| Vanette Cargo 2.3 D (C23)              | 96 → 00   |  |  | 961 753   | 962 985   |
| Vanette 2.4i (C22)                     | 09/86 → 95  |  |  | 961 724   | 962 684   |

| MODELL/MODEL/MODELE            |  | BEMERKUNGEN/REMARKS/<br>REMARQUES  |  |  |
|--------------------------------|---|--|---|---|
| Agila                          | 00 → 04   |  | 201 087   | 202 224   |
| Ascona B 1.2                   | 76 → 81   |  | 200 012   | -   |
| Ascona C 2.0                   | 82 → 88   |  | 04-P145   | -   |
| Ascona B 1.3N                  | 76 → 81   |  | 200 012   | -   |
| Ascona C 1.6, 1.8              | 82 → 88   |  | 04-P145   | -   |
| Ascona B 1.3S                  | 76 → 81   |  | 200 012   | 202 236   |
| Ascona C 1.3                   | 82 → 88   |  | 04-P149   | -   |
| Ascona B 1.6N                  | 76 → 81   |  | 200 012   | -   |
| Ascona B 1.6N Automatic        | 76 → 81   |  | 200 012   | 202 236   |
| Ascona B 1.6S                  | 76 → 81   |  | 200 012   | 202 236   |
| Ascona B 1.9                   | 76 → 81   |  | 200 012   | 202 236   |
| Ascona B 2.0                   | 76 → 81   |  | 200 012   | 202 236   |
| Ascona B 2.0 Diesel            | 76 → 81   |  | 200 012   | 202 236   |
| Ascona C 1.3                   | 82 → 88   |  | 201 040   | 200 012   |
| Ascona C 1.6 SV, 1.6 NZ        | 82 → 88   |  | 201 040   | 200 012   |
| Ascona C 1.6 NS, 1.6 SH        | 82 → 88   |  | 201 032   | 200 012   |
| Ascona C 1.6 Diesel            | 82 → 88   |  | 201 032   | 200 012   |
| Ascona C 1.8                   | 82 → 88   |  | 201 032   | 200 012   |
| Ascona C 2.0                   | 82 → 88   |  | 201 032   | 200 012   |
| Astra F 1.4, 1.6               | 92 → 98   | ABS {Front  34x64x37}   | 201 040   | 202 140   |
| Astra F 1.4, 1.6               | 92 → 98   | Ch.-->R2..... R3..., R4..., R5..., R6..... R8..  | 04-P199   | -   |
| Astra F 1.4, 1.6               | 92 → 98   | ABS {Front  34x66x37}  | 201 210   | 202 140   |
| Astra F 1.4, 1.6               | 92 → 98   | Ch.R2..., R3..., R4..... R5..., R6.....R8....-   | 04-P149   | -   |
| Astra F 1.4, 1.6               | 92 → 98   | ABS {Front  39x72x37} | 201 032   | 202 140   |
| Astra F 1.4, 1.6               | 92 → 98   |  | 04-P153   | -   |
| Astra F 1.4, 1.6               | 92 → 98   | ABS {Front  39x74x39} | 201 228   | 202 140   |
| Astra F 1.6, 1.7 TD            | 92 → 98   |  | 04-P153   | -   |
| Astra F 1.4, 1.6               | 92 → 98   | ABS {Front  34x64x37} | 201 040   | 202 142   |
| Astra F 1.7D, 1.7 TD           | 92 → 98   |  | 04-P199   | -   |
| Astra F 1.4, 1.6               | 92 → 98   | ABS {Front  34x66x37} | 201 210   | 202 142   |
| Astra F 1.7D, 1.7 TD           | 92 → 98   |  | 04-P153   | -   |
| Astra F 1.4, 1.6               | 92 → 98   | ABS {Front  39x72x37} | 201 032   | 202 142   |
| Astra F 1.8                    | 92 → 98   |  | 04-P145   | -   |
| Astra F 1.4, 1.6               | 92 → 98   | ABS {Front  39x74x39} | 201 228   | 202 142   |
| Astra F 1.8                    | 92 → 98   |  | 04-P147   | -   |
| Astra F 1.8, 2.0               | 92 → 98   |  | 04-P145   | -   |
| Astra F 1.8, 2.0               | 92 → 98   |  | 04-P147   | -   |
| Astra F 1.7                    | 92 → 98   |  | 04-P145   | -   |
| Astra F 1.7                    | 92 → 98   |  | 04-P147   | -   |
| Astra F 1.7 D, 1.7 TD, 1.7 TDS | 92 → 98   | ABS {Front  39x72x37} | 201 032   | 202 140   |
| Astra F 1.7 D, 1.7 TD, 1.7 TDS | 92 → 98   | ABS {Front  39x74x39} | 201 228   | 202 140   |
| Astra F 1.7 D, 1.7 TD, 1.7 TDS | 92 → 98   | ABS {Front  39x72x37} | 201 032   | 202 142   |
| Astra F 1.7 D, 1.7 TD, 1.7 TDS | 92 → 98   | ABS {Front  39x74x39} | 201 228   | 202 142   |
| Astra F 1.8, 2.0               | 92 → 98   | ABS {Front  39x72x37} | 201 032   | 202 140   |
| Astra F 1.8, 2.0               | 92 → 98   | ABS {Front  39x74x39} | 201 228   | 202 140   |
| Astra F 1.8, 2.0               | 92 → 98   | ABS {Front  39x72x37} | 201 032   | 202 142   |
| Astra F 1.8, 2.0               | 92 → 98   | ABS {Front  39x74x39} | 201 228   | 202 142   |
| Astra G 1.2 16V                | 98 → 00   | ABS  | 201 033   | 202 140   |
| Astra G 1.2 16V                | 98 → 00   | ABS  | 201 035   | 202 142   |
| Astra G 1.4 16V                | 98 → 04   | ABS  | 201 033   | 202 140   |
| Astra G 1.4 16V                | 98 → 04   | ABS  | 201 035   | 202 142   |
| Astra G 1.6                    | 98 → 00   | ABS  | 201 033   | 202 140   |
| Astra G 1.6                    | 98 → 00   | ABS  | 201 035   | 202 142   |
| Astra G 1.6 16V                | 98 → 04   | ABS  | 201 033   | 202 140   |



| MODELL/MODEL/MODELE          |  | BEMERKUNGEN/REMARKS/<br>REMARQUES  |  |  |  |
|------------------------------|---|--|--|---|---|
| Astra G 1.6 16V              | 98 → 04   | ABS  |  | 201 035   | 202 142   |
| Astra G 1.7 TD               | 98 → 00   | <del>ABS</del>   |  | 201 033   | 202 140   |
| Astra G 1.7 TD               | 98 → 00   | ABS  |  | 201 035   | 202 142   |
| Astra G 1.7 DTI 16V          | 00 → 04   | <del>ABS</del>   |  | 201 033   | 202 140   |
| Astra G 1.7 DTI 16V          | 00 → 04   | ABS  |  | 201 035   | 202 142   |
| Astra G 1.8 16V              | 98 → 00   | <del>ABS</del>   |  | 201 033   | 202 140   |
| Astra G 1.8 16V              | 98 → 00   | ABS  |  | 201 043   | 202 218   |
| Astra G 1.8 16V Coupé        | 03/00 → 10/00   | <del>ABS</del>   |  | 201 031   | 202 059   |
| Astra G 1.8 16V Coupé        | 03/00 → 10/00   | ABS  |  | 201 043   | 202 218   |
| Astra G 2.0 16V              | 98 → 04   | <del>ABS</del>   |  | 201 031   | 202 059   |
| Astra G 2.0 16V              | 98 → 04   | ABS  |  | 201 043   | 202 218   |
| Astra G 2.0 DI               | 98 → 99   | <del>ABS</del> Man.GBX F18   |  | 201 035   | 202 140   |
| Astra G 2.0 DI               | 00 → 04   | <del>ABS</del> Man.GBX F18   |  | 201 033   | 202 140   |
| Astra G 2.0 DI               | 98 → 04   | <del>ABS</del> Man.GBX F23   |  | 201 033   | 202 140   |
| Astra G 2.0 DI               | 98 → 04   | <del>ABS</del> Aut.GBX   |  | 201 033   | 202 140   |
| Astra G 2.0 DI               | 98 → 04   | ABS  |  | 201 043   | 202 218   |
| Astra G 2.0 DTI 16V          | 98 → 04   | <del>ABS</del>   |  | 201 031   | 202 059   |
| Astra G 2.0 DTI 16V          | 98 → 04   | ABS  |  | 201 043   | 202 218   |
| Astra G 2.2 16V              | 00 → 04   | <del>ABS</del>   |  | 201 031   | 202 059   |
| Astra G 2.2 16V              | 00 → 04   | ABS  |  | 201 043   | 202 218   |
| Astra G 2.2 DTI              | 00 → 04   | ABS  |  | 201 043   | 202 218   |
| Astra G 2.2 DTI              | 00 → 04   | <del>ABS</del>   |  | 201 031   | 202 059   |
| Astra H                      | 03/04 → 06  |  x4 |  | 201 621   | 202 625   |
| Astra H                      | 03/04 → 06  |  x5 |  | 201 623   | 202 627   |
| Astra H TwinTop              | 09/05 → 06  |  x4 |  | 201 621   | 202 625   |
| Astra H TwinTop              | 09/05 → 06  |  x5 |  | 201 623   | 202 627   |
| Astra Classic                | 99 → 02   | <del>ABS</del>   |  | 201 210   | 202 140   |
| Astra Classic                | 99 → 02   | ABS  |  | 201 210   | 202 142   |
| Calibra C20NE, C20XE, X20XEV | 89 → 95   |  |  | 201 032   | 202 168   |
| Calibra 2.0                  | 89 → 97   | Ch.T1,T9-->  |  | 04-P147   | -   |
| Calibra C20NE, X20XEV        | 96 → 97   |  |  | 201 228   | 202 168   |
| Calibra 2.0                  | 89 → 97   | Ch.-->S1, S9   |  | 04-P145   | -   |
| Calibra C20XE                | 96 → 97   |     |  | 201 032   | 202 168   |
| Calibra 2.5                  | 89 → 97   | P1000001-->, P9000001-->   |  | 04-P151   | -   |
| Calibra C20XE                | 96 → 97   |     |  | 201 228   | 202 168   |
| Calibra C20LET               | 89 → 92   |  |  | 201 032   | 202 168   |
| Calibra C20LET               | 93 → 97   |  |  | 201 228   | 202 168   |
| Calibra C25XE, X25XE         | 93 → 97   |  |  | 201 228   | 202 168   |
| Campo 4x4 (TFR)              | 91 → 00   |  |  | 201 262   | 202 205   |
| Commodore C                  | 78 → 82   | Ch.91362918-->   |  | 200 020   | 202 204   |
| Corsa A                      | 83 → 92   |  |  | 201 040   | 200 012   |
| Corsa                        | 83 → 92   |  |  | 04-P149   | -   |
| Corsa B                      | 93 → 09/00  |  |  | 201 210   | 200 012   |
| Corsa B Combo                | 93 → 09/00  |  |  | 201 210   | 200 020   |
| Corsa C                      | 10/00 → 05  |     |  | 201 095   | 202 021   |
| Corsa C                      | 10/00 → 05  |     |  | 201 095   | 202 023   |
| Corsa C Combo                | 10/00 → 04  | <del>ABS</del>   |  | 201 095   | 202 140   |
| Corsa C Combo                | 10/00 → 04  | ABS  |  | 201 095   | 202 142   |
| Frontera A 2.0i Catalytic    | 92 → 98   | Mot.C20NE  |  | 201 262   | 202 153   |
| Frontera A 2.0i Ecotec       | 92 → 98   | Mot.X20SE  |  | 201 262   | 202 155   |
| Frontera A 2.2i              | 92 → 98   |  |  | 201 262   | 202 155   |
| Frontera A 2.3 TD            | 92 → 98   |  |  | 201 262   | 202 153   |
| Frontera A 2.4i              | 92 → 98   |  |  | 201 262   | 202 153   |
| Frontera A 2.5 TDS, 2.8 TD   | 92 → 98   |  |  | 201 262   | 202 155   |

































| MODELL/MODEL/MODELE                       |  | BEMERKUNGEN/REMARKS/<br>REMARQUES  |  |  |
|---|---|--|---|---|
| Frontera B                                | 99 → 04   |  | 201 262   | 202 155   |
| Kadett C 1.0                              | 76 → 79   | Ch.52696300/55151639→  | 200 012   | -   |
| Kadett E 1.2, 1.3                         | 85 → 93   |  | 04-P149   | -   |
| Kadett C 1.2                              | 76 → 79   | Ch.52696300/55151639→  | 200 012   | -   |
| Kadett E 1.4, 1.6                         | 85 → 93   |  | 04-P149   | -   |
| Kadett C 1.6, 1.9, 2.0                    | 76 → 79   |  | 200 012   | 202 236   |
| Kadett E 1.6, 1.8                         | 85 → 93   |  | 04-P145   | -   |
| Kadett D 1.0, 1.2, 1.3                    | 80 → 84   |  | 201 040   | 200 012   |
| Kadett E 1.6, 1.8, 2.0                    | 85 → 93   |  | 04-P145   | -   |
| Kadett D 1.6, 1.6 Diesel                  | 82 → 84   |  | 201 032   | 200 012   |
| Kadett E 2.0                              | 85 → 93   |  | 04-P145   | -   |
| Kadett D 1.8                              | 82 → 84   |  | 201 032   | 200 012   |
| Kadett E 1.2, 1.3, 1.4                    | 85 → 91   |  | 201 040   | 200 012   |
| Kadett E 1.6 LZ, 1.6 NZ, 1.6 SV           | 85 → 91   |  | 201 040   | 200 012   |
| Kadett E 1.6 S                            | 85 → 91   |  | 201 032   | 200 012   |
| Kadett E 1.6 Diesel                       | 85 → 91   |  | 201 032   | 200 012   |
| Kadett E 1.7 Diesel                       | 85 → 91   |  | 201 032   | 200 012   |
| Kadett E 1.8, 2.0                         | 85 → 91   |  | 201 032   | 200 012   |
| Kadett E Cabriolet 1.4                    | 85 → 93   |  | 201 040   | 200 012   |
| Kadett E Cabriolet 1.6 LZ, 1.6 NZ, 1.6 SV | 85 → 93   |  | 201 040   | 200 012   |
| Kadett E Cabriolet 1.6 S                  | 85 → 93   |  | 201 032   | 200 012   |
| Kadett E Cabriolet 2.0                    | 85 → 93   |  | 201 032   | 200 012   |
| Kadett E Combo                            | 86 → 94   |  | 201 032   | 200 020   |
| Manta B 1.2                               | 76 → 88   |  | 200 012   | -   |
| Manta B 1.3 N                             | 76 → 88   |  | 200 012   | -   |
| Manta B 1.3 S                             | 76 → 88   |  | 200 012   | 202 236   |
| Manta B 1.6 N                             | 76 → 88   | Man.GBX  | 200 012   | -   |
| Manta B 1.6 N Automatic                   | 76 → 88   | Aut.GBX  | 200 012   | 202 236   |
| Manta B 1.6 S                             | 76 → 88   |  | 200 012   | 202 236   |
| Manta B 1.9                               | 76 → 88   |  | 200 012   | 202 236   |
| Manta B 2.0                               | 76 → 88   |  | 200 012   | 202 236   |
| Meriva 1.3 CDTI                           | 03 → 05   | ABS  x4 | 201 095   | 202 140   |
| Meriva 1.3 CDTI                           | 03 → 05   | ABS  x4 | 201 095   | 202 142   |
| Meriva 1.4 16V Twinport                   | 04 → 05   | ABS  x4 | 201 095   | 202 140   |
| Meriva 1.4 16V Twinport                   | 04 → 05   | ABS  x4 | 201 095   | 202 142   |
| Meriva 1.6, 1.6 16V                       | 03 → 05   | ABS  x4 | 201 095   | 202 140   |
| Meriva 1.6, 1.6 16V                       | 03 → 05   | ABS  x4 | 201 095   | 202 142   |
| Meriva 1.7 DTI                            | 03 → 05   | ABS  x4 | 201 095   | 202 140   |
| Meriva 1.7 DTI                            | 03 → 05   | ABS  x4 | 201 095   | 202 142   |
| Meriva 1.7 CDTI                           | 03 → 05   | ABS  x5 | 201 032   | 202 059   |
| Meriva 1.7 CDTI                           | 03 → 05   | ABS  x5 | 201 032   | 202 218   |
| Meriva 1.8                                | 03 → 05   | ABS  x4 | 201 095   | 202 140   |
| Meriva 1.8                                | 03 → 05   | ABS  x4 | 201 095   | 202 142   |
| Monterey A 3.1 TD (UBS)                   | 91 → 07/98  |  | 201 262   | 932 864   |
| Monterey A 3.2i V6 24V (UBS)              | 91 → 07/98  |  | 201 262   | 932 864   |
| Monterey B 3.0 TDI 16V (UBS)              | 07/98 → 99  |  | 201 262   | 932 864   |
| Monterey B 3.5i V6 26V (UBS)              | 07/98 → 99  |  | 201 262   | 932 864   |
| Monza                                     | 78 → 87   | Ch.91362918→   | 200 020   | 202 226   |
| Omega A 1.8                               | 87 → 93   |  | 201 084   | 202 026   |
| Omega A 2.0                               | 87 → 93   |  | 201 084   | 202 026   |
| Omega A 2.3 Diesel                        | 87 → 93   |  | 201 084   | 202 026   |
| Omega A 2.3 Turbo Diesel                  | 87 → 93   |  | 201 084   | 202 168   |
| Omega A 2.4                               | 87 → 93   |  | 201 084   | 202 168   |
| Omega A 2.6                               | 87 → 93   |  | 201 084   | 202 168   |

**MODELL/MODEL/MODELE**







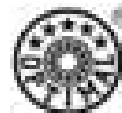





































**BEMERKUNGEN/REMARKS/  
REMARQUES**



|                                 |                   |            |                                 |         |         |
|---------------------------------|-------------------|------------|---------------------------------|---------|---------|
| Omega A 3.0                     |                   | 87 → 93    |                                 | 201 084 | 202 168 |
| Omega A 3.6 24V Lotus           |                   | 90 → 93    |                                 | 201 084 | 202 168 |
| Omega A Caravan                 |                   | 87 → 93    |                                 | 201 084 | 202 168 |
| Omega B                         |                   | 94 → 07/03 |                                 | 201 084 | 201 228 |
| Omega B Caravan                 |                   | 94 → 07/03 |                                 | 201 084 | 202 168 |
| Rekord D                        |                   | 72 → 77    |                                 | 200 012 | 202 202 |
| Rekord D Caravan                |                   | 72 → 77    |                                 | 200 012 | 202 204 |
| Rekord E 1.7                    |                   | 78 → 82    | ☹ Man.GBX                       | 200 012 | 202 202 |
| Rekord E 1.7                    |                   | 78 → 82    | ☹ Aut.GBX                       | 200 020 | 202 202 |
| Rekord E 1.7 Caravan            |                   | 78 → 82    | ☹ Man.GBX                       | 200 012 | 202 204 |
| Rekord E 1.7 Caravan            |                   | 78 → 82    | ☹ Aut.GBX                       | 200 020 | 202 204 |
| Rekord E 1.8                    |                   | 83 → 86    |                                 | 200 012 | 202 202 |
| Rekord E 1.8 Caravan            |                   | 83 → 86    |                                 | 200 012 | 202 204 |
| Rekord E 1.9                    |                   | 78 → 82    | ☹ Man.GBX                       | 200 012 | 202 202 |
| Rekord E 1.9                    |                   | 78 → 82    | ☹ Aut.GBX                       | 200 020 | 202 202 |
| Rekord E 1.9 Caravan            |                   | 78 → 82    | ☹ Man.GBX                       | 200 012 | 202 204 |
| Rekord E 1.9 Caravan            |                   | 78 → 82    | ☹ Aut.GBX                       | 200 020 | 202 204 |
| Rekord E 2.0                    |                   | 78 → 86    | ☹ Man.GBX                       | 200 012 | 202 202 |
| Rekord E 2.0                    |                   | 78 → 86    | ☹ Aut.GBX                       | 200 020 | 202 202 |
| Rekord E 2.0 E Berlina          |                   | 78 → 81    | Ch.→11028762                    | 200 020 | 202 202 |
| Rekord E 2.0 E Berlina          |                   | 81 → 84    | Ch.11028763→                    | 200 012 | 202 202 |
| Rekord E 2.0 Diesel             |                   | 78 → 82    |                                 | 200 020 | 202 204 |
| Rekord E 2.1 Diesel             |                   | 78 → 79    |                                 | 200 020 | 202 204 |
| Rekord E 2.2 E Berlina          |                   | 85 → 86    |                                 | 200 012 | 202 204 |
| Rekord E 2.2 Turbo Diesel       |                   | 85 → 86    |                                 | 200 020 | 202 204 |
| Rekord E 2.3 Diesel             |                   | 79 → 86    |                                 | 200 020 | 202 204 |
| Senator A                       |                   | 78 → 87    | Ch.91362918→                    | 200 020 | 202 226 |
| Senator B                       |                   | 88 → 93    |                                 | 201 084 | 202 168 |
| Signum                          |                   | 03 → 01/05 | Ch.→41999999                    | 201 517 | 202 519 |
| Signum                          |                   | 01/05 → 06 | Ch.51000001→                    | 201 691 | 202 519 |
| Sintra                          |                   | 96 → 99    |                                 | 201 671 | 202 673 |
| Speedster                       |                   | 00 → 05    |                                 | 201 043 | 201 043 |
| Tigra                           |                   | 94 → 00    |                                 | 201 210 | 200 012 |
| Tigra                           |                   | 93 → -     |                                 | 04-P149 | -       |
| Tigra TwinTop                   |                   | 04 → 05    | ☹                               | 201 095 | 202 021 |
| Tigra TwinTop                   |                   | 04 → 05    | ☹                               | 201 095 | 202 023 |
| Vectra A 1.4                    |                   | 89 → 92    |                                 | 201 040 | 200 012 |
| Vectra A 1.4                    | 14NV.16SV         | 89 → 95    | M.T.                            | 04-P149 | -       |
| Vectra A 1.4                    |                   | 93 → 93    | ABS                             | 201 040 | 202 140 |
| Vectra A 1.6                    | 16SV              | 89 → 95    | A.T.                            | 04-P199 | -       |
| Vectra A 1.4                    |                   | 93 → 93    | ABS                             | 201 040 | 202 142 |
| Vectra A 1.6                    | E16NZ,C16NZ,X16SZ | 89 → 95    |                                 | 04-P149 | -       |
| Vectra A 1.6                    |                   | 89 → 95    | Ch.-->P1....., P5....., P7....  | 04-P145 | -       |
| Vectra A 1.6                    |                   | 89 → 92    | Man.GBX                         | 201 040 | 200 012 |
| Vectra A 1.6                    |                   | 89 → 95    | Ch.R1..... R5....., R75.....--> | 04-P149 | -       |
| Vectra A 1.6                    |                   | 93 → 93    | Man.GBX ABS                     | 201 040 | 202 140 |
| Vectra A 1.8, 2.0               |                   | 89 → 95    |                                 | 04-P145 | -       |
| Vectra A 1.6                    |                   | 93 → 93    | Man.GBX ABS                     | 201 040 | 202 142 |
| Vectra A 1.7D, 1.7TD            |                   | 89 → 95    |                                 | 04-P145 | -       |
| Vectra A 1.6 Automatic          |                   | 89 → 92    | Aut.GBX                         | 201 032 | 200 012 |
| Vectra B 1.6                    | X16ZR.X16XEL      | 96 → -     |                                 | 04-P153 | -       |
| Vectra A 1.6 Automatic          |                   | 93 → 93    | Aut.GBX ABS                     | 201 032 | 202 140 |
| Vectra B 1.6, 2.0, 1.7TD, 2.0TD |                   | 96 → -     | Ch.-->W1.....W5....., W7....    | 04-P147 | -       |
| Vectra A 1.6 Automatic          |                   | 93 → 93    | Aut.GBX ABS                     | 201 032 | 202 142 |





| MODELL/MODEL/MODELE             |  | BEMERKUNGEN/REMARKS/<br>REMARQUES  |  |  |
|---------------------------------|---|--|---|---|
| Vectra B 1.6, 2.0, 1.7TD, 2.0TD | 96 → -  | Ch.X..... X7....-->  | 04-P151   | -   |
| Vectra A 1.6                    | 94 → 95   | <del>ABS</del>   | 201 210   | 202 140   |
| Vectra B 1.8                    | 96 → -  | Ch.-->W1....., W5....., W7....   | 04-P147   | -   |
| Vectra A 1.6                    | 94 → 95   | ABS  | 201 210   | 202 142   |
| Vectra B 1.8                    | 96 → -  | Ch.X1000001-->,X7000001-->   | 04-P151   | -   |
| Vectra B 2.0                    | 96 → -  |  | 04-P151   | -   |
| Vectra B 2.0 TD                 | 96 → -  | Ch.X1000001-->,X7000001-->   | 04-P151   | -   |
| Vectra A 1.7 D, 1.7 TD          | 89 → 92   |  | 201 032   | 200 012   |
| Vectra A 1.7 D, 1.7 TD          | 93 → 95   | <del>ABS</del>   | 201 032   | 202 140   |
| Vectra A 1.7 D, 1.7 TD          | 93 → 95   | ABS  | 201 032   | 202 142   |
| Vectra A 1.8                    | 89 → 92   |  | 201 032   | 200 012   |
| Vectra A 1.8                    | 93 → 95   | <del>ABS</del>   | 201 032   | 202 140   |
| Vectra A 1.8                    | 93 → 95   | ABS  | 201 032   | 202 142   |
| Vectra A 2.0                    | 89 → 92   |  | 201 032   | 200 012   |
| Vectra A 2.0                    | 93 → 95   | <del>ABS</del>   | 201 032   | 202 140   |
| Vectra A 2.0                    | 93 → 95   | ABS  | 201 032   | 202 142   |
| Vectra A 2.0 4x4                | 89 → 92   |  | 201 032   | 202 168   |
| Vectra A 2.0 4x4                | 93 → 95   |  | 201 228   | 202 168   |
| Vectra A 2.5 6V                 | 93 → 95   |  | 201 228   | 202 218   |
| Vectra A 2.5 6V 4x4             | 93 → 95   |  | 201 228   | 202 168   |
| Vectra B 1.6 i, 1.6 i 16V       | 95 → 98   |  x4                                   | 201 228   | 202 142   |
| Vectra B 1.7 TD                 | 95 → 98   |  x4                                   | 201 228   | 202 142   |
| Vectra B 1.8 i 16V              | 95 → 98   |  x4                                  | 201 228   | 202 142   |
| Vectra B 2.0 i                  | 95 → 98   |  x4                                 | 201 228   | 202 142   |
| Vectra B 2.0 i 16V              | 95 → 98   |  x5                                 | 201 228   | 202 218   |
| Vectra B 2.0 DI 16V             | 96 → 98   |  x4                                 | 201 228   | 202 142   |
| Vectra B 2.0 DTI 16V            | 97 → 98   |  x4                                 | 201 228   | 202 142   |
| Vectra B 2.5 i V6               | 95 → 98   |  x5                                 | 201 228   | 202 218   |
| Vectra B                        | 99 → 02   |  x5                                 | 201 228   | 202 218   |
| Vectra C                        | 02 → 01/05  | Ch.→41999999   | 201 517   | 202 519   |
| Vectra C                        | 01/05 → 06  | Ch.51000001→   | 201 691   | 202 519   |
| Zafira                          | 99 → 04   | <del>ABS</del>  x5                  | 201 031   | 202 059   |
| Zafira                          | 99 → 04   | ABS  x5                             | 201 043   | 202 218   |
| Zafira                          | 07/05 → 06  |  | 201 623   | 202 627   |
| Arena 1.9 D                     | TF19D-F8Q-606   | 97 → 03                             | 701 404   | 702 436   |
| Arena 1.9 D                     | TF19D-F8Q-600   | 97 → 03  Ch.→B014311 <del>ABS</del> | 701 404   | 702 586   |
| Arena 1.9 D                     | TF19D-F8Q-600   | 97 → 03  Ch.→B014311 ABS            | 701 404   | 702 436   |
| Arena 1.9 D                     | TF19D-F8Q-600   | 97 → 03  Ch.B014312→ <del>ABS</del> | 701 424   | 702 586   |
| Arena 1.9 D                     | TF19D-F8Q-600   | 97 → 03  Ch.B014312→ ABS            | 701 424   | 702 436   |
| Arena 1.9 D                     | TH19D-F8Q-600   | 97 → 03  Ch.→B002817 <del>ABS</del> | 701 404   | 702 586   |
| Arena 1.9 D                     | TH19D-F8Q-600   | 97 → 03  Ch.→B002817 ABS            | 701 404   | 702 436   |
| Arena 1.9 D                     | TH19D-F8Q-600   | 97 → 03  Ch.B002818→ <del>ABS</del> | 701 424   | 702 586   |
| Arena 1.9 D                     | TH19D-F8Q-600   | 97 → 03  Ch.B002818→ ABS            | 701 424   | 702 436   |
| Arena 2.5 D                     | TH25D-S8U-782   | 97 → 03                             | 701 404   | 702 436   |
| Arena 2.5 D                     | TF25D-S8U-780   | 97 → 03  Ch.→B014308                | 701 404   | 702 436   |
| Arena 2.5 D                     | TF25D-S8U-780   | 97 → 03  Ch.B014309→                | 701 424   | 702 436   |
| Arena 2.5 D                     | TH25D-S8U-780   | 97 → 03  Ch.→B002825                | 701 404   | 702 436   |
| Arena 2.5 D                     | TH25D-S8U-780   | 97 → 03  Ch.B002826→                | 701 424   | 702 436   |
| Movano                          | 98 → 04   |                                     | 701 860   | 702 846   |
| Vivaro                          | 01 → 03   |  <del>ABS</del>                     | 201 085   | 202 101   |
| Vivaro                          | 01 → 03   |  ABS - Active Sensor Bearing        | 201 089   | 202 101   |

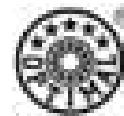





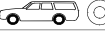

















































| MODELL/MODEL/MODELE              |                 | BEMERKUNGEN/REMARKS/<br>REMARQUES |                                      |         |         |
|----------------------------------|-----------------|-----------------------------------|--------------------------------------|---------|---------|
| 104                              | 07/80 → 88      | Ch.5496582/7029645→               | {Front  48x72,5x10}                  | 601 654 | 602 414 |
| 104                              | 07/80 → 88      | Ch.5496582/7029645→               | {Front  54x72,5x9}                   | 601 396 | 602 414 |
| 106                              | TU32,TU3M,TU3FJ | 91 → -                            | 4                                    | 04-P187 | -       |
| 106 1.0, 1.1                     | TU9,TU1,TU1M    | 91 → -                            | 3                                    | 04-P189 | -       |
| 106 1.0, 1.1                     |                 | 91 → 01/99                        | x3                                   | 600 334 | 602 322 |
| 106 1.0, 1.1                     |                 | 02/99 → 02                        | x3                                   | 600 334 | 602 926 |
| 106 1.0, 1.1                     |                 | 91 → 01/99                        | x4                                   | 601 306 | 602 320 |
| 106 1.0, 1.1                     |                 | 02/99 → 02                        | x4                                   | 601 916 | 602 858 |
| 106 1.3                          |                 | 91 → 96                           |                                      | 601 306 | 602 320 |
| 106 1.4                          |                 | 91 → 01/99                        |                                      | 601 306 | 602 320 |
| 106 1.4                          |                 | 02/99 → 02                        |                                      | 601 916 | 602 858 |
| 106 1.4 Diesel                   |                 | 92 → 96                           |                                      | 601 306 | 602 320 |
| 106 1.5 Diesel                   |                 | 94 → 01/99                        |                                      | 601 306 | 602 320 |
| 106 1.5 Diesel                   |                 | 02/99 → 02                        |                                      | 601 916 | 602 858 |
| 106 1.6                          |                 | 94 → 01/99                        | Mot.TU5JP                            | 601 306 | 602 320 |
| 106 1.6                          |                 | 02/99 → 02                        | Mot.TU5JP                            | 601 306 | 602 858 |
| 106 1.6                          |                 | 94 → 01/99                        | Mot.TU5J2, TU5J4 <del>ABS</del>      | 601 306 | 602 347 |
| 106 1.6                          |                 | 94 → 01/99                        | Mot.TU5J2, TU5J4 ABS                 | 601 306 | 602 349 |
| 106 1.6                          |                 | 02/99 → 02                        | Mot.TU5J2, TU5J4 <del>ABS</del>      | 601 916 | 602 347 |
| 106 1.6                          |                 | 02/99 → 02                        | Mot.TU5J2, TU5J4 ABS                 | 601 916 | 602 349 |
| 106 SA13 Electrique              |                 | 97 → 01/99                        |                                      | 601 306 | 602 320 |
| 106 SA13 Electrique              |                 | 02/99 → 02                        |                                      | 601 306 | 602 858 |
| 107 1.0, 1.4 HDi                 |                 | 06/05 → 12/06                     |                                      | 601 834 | 602 835 |
| 1007                             | Front           | 04/05 → 12/05                     | <del>ABS</del>                       | 601 253 | -       |
| 1007                             | Front           | 04/05 → 12/05                     | ABS - Active Sensor Bearing          | 601 916 | -       |
| 1007                             | Rear            | 04/05 → 12/05                     |                                      | -       | 602 251 |
| 1007                             | Rear            | 04/05 → 12/05                     |                                      | -       | 602 669 |
| 205 1.0, 1.1, 1.2, 1.3, 1.4, 1.5 |                 | 83 → 98                           |                                      | 601 306 | 602 320 |
| 205                              |                 | 83 → 98                           | ABS                                  | 04-P191 | -       |
| 205 1.6, 1.6 GTI                 |                 | 85 → 98                           | <del>ABS</del>                       | 601 306 | 602 320 |
| 205                              |                 | 83 → 98                           |                                      | 04-P187 | -       |
| 205 1.6, 1.6 GTI                 |                 | 85 → 98                           | ABS                                  | 600 308 | 602 314 |
| 205 1.7 D, 1.7 TD                |                 | 85 → 00                           | <del>ABS</del> {Rear  }              | 601 306 | 602 320 |
| 205 1.7 D, 1.7 TD                |                 | 85 → 00                           | ABS {Rear  }                         | 600 308 | 602 320 |
| 205 1.8 Diesel, 1.8 Turbo Diesel |                 | 85 → 98                           | <del>ABS</del>                       | 601 306 | 602 320 |
| 205 1.8 Diesel, 1.8 Turbo Diesel |                 | 85 → 98                           | ABS                                  | 600 308 | 602 320 |
| 205 1.9                          |                 | 85 → 98                           | <del>ABS</del>                       | 601 306 | 602 320 |
| 205 1.9                          |                 | 85 → 98                           | ABS                                  | 600 308 | 602 314 |
| 205 1.9 GTI                      |                 | 87 → 98                           | <del>ABS</del>                       | 600 308 | 602 338 |
| 205 1.9 GTI                      |                 | 87 → 98                           | ABS                                  | 600 308 | 602 314 |
| 205 1.9 Diesel                   |                 | 85 → 98                           | <del>ABS</del>                       | 601 306 | 602 320 |
| 205 1.9 Diesel                   |                 | 85 → 98                           | ABS                                  | 600 308 | 602 320 |
| 206 1.1i, 1.4i                   |                 | 01/98 → 09/98                     | {Rear  } Ch.→7958                    | 601 916 | 602 320 |
| 206                              |                 | 98 → -                            |                                      | 04-P195 | -       |
| 206 1.1i, 1.4i, 1.4 HDi          |                 | 09/98 → 05                        | {Rear  } Ch.7959→                    | 601 916 | 602 858 |
| 206 1.1i, 1.4i, 1.4 HDi          |                 | 98 → 09/02                        | {Rear  }                             | 601 916 | 602 249 |
| 206 1.1i, 1.4i, 1.4 HDi          |                 | 09/02 → 05                        | {Rear  } ABS - Active Sensor Bearing | 601 916 | 602 251 |
| 206 1.4 HDi eco 70               |                 | 01 → 05                           |                                      | 601 916 | 602 858 |
| 206 1.6i                         |                 | 01/98 → 09/98                     | Ch.→7958                             | 601 916 | 602 320 |
| 206 1.6i                         |                 | 09/98 → 05                        | Ch.7959→                             | 601 916 | 602 858 |
| 206 1.6 16V                      |                 | 99 → 05                           | {Rear  }                             | 600 308 | 602 858 |
| 206 1.6 16V                      |                 | 99 → 09/02                        | {Rear  }                             | 600 308 | 602 249 |
| 206 1.6 16V                      |                 | 09/02 → 05                        | {Rear  } ABS - Active Sensor Bearing | 600 308 | 602 251 |
| 206 1.6 HDi                      |                 | 04 → 05                           | {Rear  }                             | 600 308 | 602 858 |



| MODELL/MODEL/MODELE              |  | BEMERKUNGEN/REMARKS/<br>REMARQUES   |  |  |
|----------------------------------|---|---|---|---|
| 206 1.6 HDi                      | 04 → 05   | {Rear  } ABS - Active Sensor Bearing   | 600 308   | 602 251   |
| 206 1.9 Diesel                   | 01/98 → 09/98   | Ch.→7958  | 601 916   | 602 320   |
| 206 1.9 Diesel                   | 09/98 → 01  | Ch.7959→  | 601 916   | 602 858   |
| 206 2.0 S16, 2.0 16V             | 00 → 05   | {Rear  }   | 600 308   | 602 858   |
| 206 2.0 S16, 2.0 16V             | 00 → 09/02  | {Rear  }   | 600 308   | 602 249   |
| 206 2.0 S16, 2.0 16V             | 09/02 → 03  | {Rear  } ABS - Active Sensor Bearing   | 600 308   | 602 251   |
| 206 2.0 RC                       | 03 → 05   | {Rear  } ABS - Active Sensor Bearing   | 600 308   | 602 251   |
| 206 2.0 HDi                      | 99 → 05   | {Rear  }   | 600 308   | 602 858   |
| 206 2.0 HDi                      | 99 → 05   | {Rear  } ABS - Active Sensor Bearing   | 600 308   | 602 251   |
| 206 Cabriolet                    | 99 → 09/02  | Ch.→9456  | 600 308   | 602 249   |
| 206 Cabriolet                    | 09/02 → 05  | Ch.9457→ ABS - Active Sensor Bearing  | 600 308   | 602 251   |
| 207 1.4                          | 02/06 → 12/06   |   | 601 253   | -   |
| 207 1.4 16 V                     | 02/06 → 12/06   |   | 601 253   | -   |
| 207 1.4 HDi                      | 02/06 → 12/06   |   | 601 953   | -   |
| 207 1.6 16 V                     | 02/06 → 12/06   |   | 601 953   | -   |
| 207 1.6 HDi                      | 02/06 → 12/06   |   | 601 953   | -   |
| 304                              | 09/72 → 80  |   | 601 495   | 602 541   |
| 305                              | 78 → 82   |   | 601 495   | 602 859   |
| 305                              | 83 → 08/84  | Ch.→9404638   | 601 336   | 602 340   |
| 305                              | 09/84 → 91  | Ch.9404639→   | 600 308   | 602 340   |
| 306 I                            | 93 → 97   | <del>ABS</del> {Front  35x72x33} {Rear  }     | 601 306   | 602 320   |
| 306                              | 93 → -  | ABS   | 04-P191   | -   |
| 306 I                            | 93 → 97   | <del>ABS</del> {Front  42x82x36} {Rear  }   | 600 308   | 602 314   |
| 306                              | 93 → -  | ABS   | 04-P187   | -   |
| 306 I                            | 93 → 06/95  | ABS Bendix {Rear  }  | 600 308   | 602 320   |
| 306 I                            | 93 → 06/95  | ABS Bosch {Rear  }   | 600 308   | 602 361   |
| 306 I                            | 07/95 → 97  | ABS Bosch {Rear  }   | 600 308   | 602 320   |
| 306 I                            | 93 → 97   | ABS {Rear  }   | 600 308   | 602 314   |
| 306 I                            | 93 → 97   | Reinforced suspension <del>ABS</del> {Front  35x72x33}   | 601 306   | 602 320   |
| 306 I                            | 93 → 97   | Reinforced suspension <del>ABS</del> {Front  42x82x36}   | 600 308   | 602 320   |
| 306 I                            | 93 → 97   | Reinforced suspension ABS   | 600 308   | 602 320   |
| 306 I Entreprise                 | 93 → 97   | <del>ABS</del> {Front  35x72x33} {Rear  } | 601 306   | 602 320   |
| 306 I Entreprise                 | 93 → 97   | <del>ABS</del> {Front  42x82x36} {Rear  } | 600 308   | 602 320   |
| 306 I Entreprise                 | 93 → 97   | ABS {Rear  }   | 600 308   | 602 361   |
| 306 II 1.1, 1.4                  | Front 97 → 01/99  | Mot.TU3 <del>ABS</del> Steel wheel rim  | 601 306   | -   |
| 306 II 1.1, 1.4                  | Front 02/99 → 04  | Mot.TU3 <del>ABS</del> Steel wheel rim  | 601 916   | -   |
| 306 II 1.1, 1.4                  | Front 97 → 04   | Mot.TU3 <del>ABS</del> Aluminium wheel rim  | 600 308   | -   |
| 306 II 1.1, 1.4                  | Front 97 → 04   | Mot.TU3 ABS   | 600 308   | -   |
| 306 II 1.6                       | Front 97 → 04   | Mot.TU5   | 600 308   | -   |
| 306 II 1.8, 1.8 D, 1.9 D/TD, 2.0 | Front 97 → 04   | Mot.XU7/XUD7/XUD9/XU10  | 600 308   | -   |
| 306 II 2.0 HdI                   | Front 98 → 04   | Mot.DW10  | 600 308   | -   |
| 306 II 1.1, 1.4, 1.6             | Rear 97 → 09/98   |  Mot.TU3/TU5   | -   | 602 320   |
| 306 II 1.1, 1.4, 1.6             | Rear 10/98 → 04   |  Mot.TU3/TU5   | -   | 602 858   |
| 306 II 1.8, 1.8 D, 1.9 D/TD, 2.0 | Rear 97 → 09/98   |  Mot.XU7/XUD7/XUD9/XU10                 | -   | 602 320   |
| 306 II 1.8, 1.8 D, 1.9 D/TD, 2.0 | Rear 97 → 09/98   |  Mot.XU7/XUD7/XUD9/XU10                 | -   | 602 314   |
| 306 II 1.8, 1.8 D, 1.9 D/TD, 2.0 | Rear 10/98 → 04   |  Mot.XU7/XUD7/XUD9/XU10                 | -   | 602 858   |
| 306 II 1.8, 1.8 D, 1.9 D/TD, 2.0 | Rear 10/98 → 04   |  Mot.XU7/XUD7/XUD9/XU10                 | -   | 602 386   |
| 306 II 2.0 HdI                   | Rear 98 → 04  |  Mot.DW10                                 | -   | 602 858   |
| 306 II 2.0 HdI                   | Rear 98 → 04  |  Mot.DW10                                 | -   | 602 386   |
| 306 II Entreprise                | Rear 97 → 09/98   |   | -   | 602 361   |
| 306 II Entreprise                | Rear 10/98 → 04   |   | -   | 602 645   |
| 306 II                           | Rear 97 → 09/98   |     | -   | 602 361   |
| 306 II                           | Rear 97 → 09/98   |     | -   | 602 314   |
| 306 II                           | Rear 10/98 → 04   |     | -   | 602 645   |





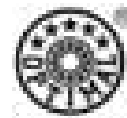

















| MODELL/MODEL/MODELE   |        | BEMERKUNGEN/REMARKS/<br>REMARQUES |  |   |         |
|-----------------------|--------|-----------------------------------|--|---|---------|
| 306 II                | Rear   | 10/98 → 04                        |           | -   | 602 386 |
| 307                   |        | 00 → 02/04                        | ABS - Active Sensor Bearing  | 601 953   | 602 956 |
| 307                   |        | 01/04 → 05                        | ABS - Active Sensor Bearing  | 601 953   | 602 893 |
| 307 SW                |        | 02 → 02/03                        | ABS - Active Sensor Bearing  | 601 953   | 602 956 |
| 307 SW                |        | 01/04 → 05                        | ABS - Active Sensor Bearing  | 601 953   | 602 893 |
| 309 1.1               | 1118cc | 86 → 93                           |  | 601 306   | 602 320 |
| 309 1.1-1.4           |        | 85 → -                            | ABS 4 [11]   | 04-P187   | -       |
| 309 1.1               | 1124cc | 86 → 89                           |  | 600 308   | 602 320 |
| 309 1.4-1.9           |        | 85 → -                            | ABS  | 04-P191   | -       |
| 309 1.1               | 1124cc | 90 → 93                           |  | 601 306   | 602 320 |
| 309 1.3               |        | 86 → 93                           |  | 601 306   | 602 320 |
| 309 1.4               | 1360cc | 86 → 89                           |  | 600 308   | 602 320 |
| 309 1.4               | 1360cc | 90 → 93                           |  | 601 306   | 602 320 |
| 309 1.4               | 1442cc | 86 → 93                           |  | 600 308   | 602 320 |
| 309 1.5, 1.6          |        | 86 → 93                           |  | 600 308   | 602 320 |
| 309 1.6 GTI           |        | 87 → 93                           |  | 600 308   | 602 338 |
| 309 1.8 Diesel        |        | 89 → 93                           |  | 600 308   | 602 320 |
| 309 1.8 Turbo Diesel  |        | 89 → 93                           |  | 600 308   | 602 320 |
| 309 1.9               |        | 86 → 93                           |  | 600 308   | 602 320 |
| 309 1.9 GTI           |        | 87 → 93                           |  | 600 308   | 602 338 |
| 309 1.9 Diesel        |        | 87 → 93                           |  | 600 308   | 602 320 |
| 309 1.9 Turbo Diesel  |        | 87 → 93                           |  | 600 308   | 602 320 |
| 405                   |        | 87 → 96                           | <del>ABS</del>   | 600 308   | 602 340 |
| 405                   |        | 87 → -                            | ABS  | 04-P191   | -       |
| 405                   |        | 87 → 96                           | ABS Bendix   | 600 308   | 602 388 |
| 405                   |        | 87 → 96                           | ABS Bosch  | 600 308   | 602 343 |
| 405 4x4               |        | 89 → 96                           |  | 600 308   | 600 308 |
| 406 I                 |        | 95 → 03/99                        | <del>ABS</del>   | 600 308   | 602 337 |
| 406 I                 |        | 95 → -                            | ABS  | 04-P191   | -       |
| 406 I                 |        | 95 → 03/99                        | ABS  29 | 600 308   | 602 367 |
| 406 II                |        | 03/99 → 03                        | ABS  48 | 600 308   | 602 339 |
| 407                   |        | 04 → 06                           | ABS - Active Sensor Bearing  | 601 675   | 602 681 |
| 407 Coupé             |        | 05 → 06                           | ABS - Active Sensor Bearing  | 601 675   | -       |
| 407 SW                |        | 04 → 06                           | ABS - Active Sensor Bearing  | 601 675   | 602 681 |
| 504 Berline GL        |        | 76 → 85                           | Ch.2181357→  | 601 384   | 602 406 |
| 504 Berline L, GR, SR |        | 76 → 85                           | Ch.2181357→  | 601 384   | 602 412 |
| 504 Break             |        | 76 → 81                           | Ch.2181357→3382961   | 601 384   | -       |
| 504 Break             |        | 81 → 85                           | Ch.3382962→  | 601 384   | 602 539 |
| 504 Cabriolet         |        | 76 → 81                           | Ch.2181357→3547547   | 601 384   | 602 406 |
| 504 Cabriolet         |        | 81 → 84                           | Ch.3547548→  | 601 384   | 602 390 |
| 504 Commerciale       |        | 76 → 81                           | Ch.2181357→3382961   | 601 384   | -       |
| 504 Commerciale       |        | 81 → 85                           | Ch.3382962→  | 601 384   | 602 539 |
| 504 Coupé             |        | 76 → 81                           | Ch.2181357→3547547   | 601 384   | 602 406 |
| 504 Coupé             |        | 81 → 84                           | Ch.3547548→  | 601 384   | 602 390 |
| 504 Familiare         |        | 76 → 81                           | Ch.2181357→3382961   | 601 384   | -       |
| 504 Familiare         |        | 81 → 85                           | Ch.3382962→  | 601 384   | 602 539 |
| 505 Berline           |        | 79 → 80                           | Ch.→1214586  | 601 384   | 602 406 |
| 505 Berline           |        | 81 → 92                           | <del>ABS</del> Ch.1214587→   | 601 384   | 602 390 |
| 505 Berline           |        | 87 → 89                           | ABS  | -   | 602 390 |
| 505 Break             |        | 82 → 92                           |  | 601 384   | 602 430 |
| 505 Familiare         |        | 82 → 92                           |  | 601 384   | 602 430 |
| 604                   |        | 75 → 80                           | Ch.→6640835  | 601 384   | 602 406 |
| 604                   |        | 81 → 87                           | Ch.6640836→  | 601 384   | 602 390 |
| 605                   |        | 90 → 04/97                        | <del>ABS</del>   | 601 348   | 602 937 |

| MODELL/MODEL/MODELE   |  | BEMERKUNGEN/REMARKS/<br>REMARQUES   |  |  |
|-----------------------|---|---|---|---|
| 605                   | 90 → 04/97  | ABS Bosch  29  | 601 348   | 602 344   |
| 605                   | 90 → 04/97  | ABS Bendix  48   | 601 348   | 602 369   |
| 605                   | 05/97 → 99  | <del>ABS</del>  | 601 323   | 602 937   |
| 605                   | 05/97 → 99  | ABS Bosch  29  | 601 323   | 602 344   |
| 605                   | 05/97 → 99  | ABS Bendix  48   | 601 323   | 602 369   |
| 607                   | 00 → 03   | ABS Bosch  29  | 601 323   | 602 927   |
| 607                   | 04 → 05   | ABS - Active Sensor Bearing Bosch  29  | 601 675   | 602 681   |
| 806                   | 95 → 02   |   | 681 303   | 682 305   |
| 806                   | 94 → -  |   | 04-P193   | -   |
| 807 2.0i 16V          | 01 → 05   | ABS - Active Sensor Bearing   | 681 261   | 682 263   |
| 807 2.0 Hdi           | 01 → 05   | ABS - Active Sensor Bearing   | 681 261   | 682 263   |
| 807 2.2i 16V          | 01 → 05   | ABS - Active Sensor Bearing   | 681 261   | 682 263   |
| 807 2.2 Hdi           | 01 → 05   | ABS - Active Sensor Bearing   | 681 261   | 682 263   |
| 807 3.0i V6 24V       | 01 → 05   | ABS - Active Sensor Bearing   | 681 259   | 682 263   |
| Expert                | 96 → 04   |   | 681 303   | 682 305   |
| Partner               | 96 → 04   | <del>ABS</del>  | 600 308   | 602 337   |
| Partner               | 96 → 04   | ABS  29  | 600 308   | 602 345   |
| Partner               | 04 → 05   | ABS - Active Sensor Bearing   | 600 308   | -   |
| 504 Camionnette       | 80 → 81   |    | 601 384   | 602 539   |
| 504 Camionnette       | 82 → 90   |    | 601 384   | 602 430   |
| Boxer 1000 kg         | 94 → 04/02  |    | 681 506   | 682 327   |
| Boxer 1800 kg         | 89 → -  |   | 04-P181   | -   |
| Boxer 1000 kg         | 04/02 → 04/06   |   | 681 375   | 682 437   |
| Boxer 1400 kg         | 94 → -  |   | 04-P185   | -   |
| Boxer 1000 kg 4x4     | 96 → 04/02  |    | 681 506   | 681 506   |
| Boxer 1000 kg 4x4     | 04/02 → 04/06   |    | 681 375   | -   |
| Boxer 1400 kg         | 94 → 04/02  |    | 681 506   | 682 327   |
| Boxer 1400 kg         | 04/02 → 04/06   |    | 681 375   | 682 437   |
| Boxer 1400 kg 4x4     | 96 → 04/02  |    | 681 506   | 681 506   |
| Boxer 1400 kg 4x4     | 04/02 → 04/06   |    | 681 375   | -   |
| Boxer 1800 kg         | 94 → 04/02  |    | 681 325   | 682 329   |
| Boxer 1800 kg         | 04/02 → 04/04   |    | 681 471   | 682 437   |
| Boxer 1800 kg 4x4     | 96 → 04/02  |    | 681 325   | 681 506   |
| Boxer 1800 kg 4x4     | 04/02 → 04/06   |    | 681 325   | -   |
| J 5 1000 kg / 1300 kg | 82 → 85   |   Ch.->244300       | 681 504   | 682 420   |
| J 5 Serie I           | - → 85  |   | 04-P207   | -   |
| J 5 1000 kg / 1300 kg | 82 → 85   |   Ch.->244300       | 681 504   | 682 422   |
| J 5 Serie II          | 85 → 89   |   | 04-P183   | -   |
| J 5 1000 kg / 1300 kg | 86 → 89   |   Ch.244301->604496 | 681 504   | 682 508   |
| J 5 Serie III         | 89 → -  |   | 04-P205   | -   |
| J 5 1000 kg / 1300 kg | 86 → 89   |   Ch.244301->604496 | 681 504   | 682 510   |
| J 5 1000 kg / 1300 kg | 89 → 92   |   Ch.604497->       | 681 506   | 682 508   |
| J 5 1000 kg / 1300 kg | 89 → 92   |   Ch.604497->       | 681 506   | 682 510   |
| J 5 1400 kg           | 88 → 89   |   Ch.->604496       | 681 504   | 682 508   |
| J 5 1400 kg           | 88 → 89   |   Ch.->604496       | 681 504   | 682 510   |
| J 5 1400 kg           | 89 → 92   |   Ch.604497->       | 681 506   | 682 508   |
| J 5 1400 kg           | 89 → 92   |   Ch.604497->       | 681 506   | 682 510   |
| J 5 1800 kg           | 82 → 89   |   Ch.->604496       | 681 504   | 682 492   |
| J 5 1800 kg           | 82 → 89   |   Ch.->604496       | 681 504   | 682 490   |
| J 5 1800 kg           | 89 → 92   |   Ch.604497->       | 681 506   | 682 492   |
| J 5 1800 kg           | 89 → 92   |   Ch.604497->       | 681 506   | 682 490   |
| J 5 4x4               | 86 → 89   |  Ch.->604496   | 681 504   | 602 430   |
| J 5 4x4               | 89 → 92   |  Ch.604497->   | 681 506   | 602 430   |
| J 7                   | 10/70 → 80  |    | 601 580   | 602 584   |







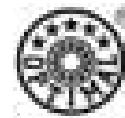

| MODELL/MODEL/MODELE | BEMERKUNGEN/REMARKS/<br>REMARQUES   |   |
|---------------------|---|---|
| J 9                 | 80 → 91  | <br>601 580    602 584 |



| MODELL/MODEL/MODELE |  | BEMERKUNGEN/REMARKS/<br>REMARQUES   |  |  |
|---------------------|---|---|---|---|
| 125p                | 74 → 91   |    | 801 402   | 802 454   |
| 125p                | 74 → 91   |    | 801 171   | 802 454   |
| 126                 | 72 → 76   |   | 801 922   | -   |
| 126, 126 Personal   | 77 → 86   |    | 801 538   | 802 464   |
| 126, 126 Personal   | 77 → 86   |    | 801 173   | 802 464   |
| 126p FL (FSM)       | 83 → 00   |    | 801 538   | 802 464   |
| 126p FL (FSM)       | 83 → 00   |    | 801 173   | 802 464   |
| 126 BIS             | 87 → 92   |    | 801 538   | 802 464   |
| 126 BIS             | 87 → 92   |    | 801 173   | 802 464   |
| FSO Polonez         | 79 → 00   |    | 801 402   | 802 454   |
| FSO Polonez         | 79 → 00   |    | 801 171   | 802 454   |
| FSO Polonez CARGO   | 96 → 00   |    | 801 402   | 682 867   |
| FSO Polonez CARGO   | 96 → 00   |    | 801 171   | 682 867   |
| FSO Polonez TRUCK   | 94 → 97   |    | 801 402   | 682 848   |
| FSO Polonez TRUCK   | 94 → 97   |    | 801 171   | 682 848   |
| FSO Polonez TRUCK   | 97 → 00   |   Lucas | 801 402   | 682 169   |
| FSO Polonez TRUCK   | 97 → 00   |   Lucas | 801 171   | 682 169   |



| MODELL/MODEL/MODELE |  | BEMERKUNGEN/REMARKS/<br>REMARQUES |  |  |
|---------------------|---|-----------------------------------|---|---|
| 911                 | 65 → 79   |                                   | 401 276   | -   |
| 911                 | 80 → 89   |                                   | 101 250   | 102 103   |
| 924                 | 76 → 85   |                                   | 100 002   | 102 266   |
| 924 Carrera GT      | 80 → 85   |                                   | 101 250   | -   |
| 924 Turbo           | 80 → 85   |                                   | 101 250   | 102 266   |
| 928                 | 77 → 85   |                                   | 101 264   | 102 268   |
| 928                 | 86 → 90   |                                   | 101 270   | 102 268   |
| 944                 | 82 → 01/85  |                                   | 101 250   | 102 266   |
| 944                 | 02/85 → 86  |                                   | 101 250   | 102 103   |
| 944                 | 87 → 90   |                                   | 101 270   | 102 103   |
| Cayenne             | 02 → 05   | ABS - Active Sensor Bearing       | 100 003   | 100 003   |

| MODELL/MODEL/MODELE |        |  | BEMERKUNGEN/REMARKS/<br>REMARQUES |  |  |  |
|---------------------|--------|---|-----------------------------------|--|---|---|
| Perdana 2.0i        | (E55A) | 94 → 95   |                                   |  | 991 902   | 992 894   |
| Persona 1.3i        | (C96)  | 93 → 98   |                                   |  | 951 409   | 952 405   |
| Persona 1.5i        | (C97)  | 93 → 98   |                                   |  | 951 409   | 952 405   |
| Persona 1.6i 16V    | (C98)  | 93 → 98   | <del>ABS</del>                    |  | 951 409   | 952 405   |
| Persona 1.6i 16V    | (C98)  | 93 → 98   | ABS                               |  | 951 409   | 952 551   |
| Persona 1.8i        | (C99)  | 95 → 98   |                                   |  | 951 409   | 952 551   |
| Saga 1.3i           | (C21A) | 86 → 93   |                                   |  | 951 606   | 952 710   |
| Saga 1.5i           | (C22A) | 86 → 93   |                                   |  | 951 606   | 952 710   |
| Satria 1.3i         | (C96)  | 94 → 98   |                                   |  | 951 409   | 952 405   |
| Satria 1.6i 16V     | (C98)  | 94 → 98   |                                   |  | 951 409   | 952 405   |
| Wira 1.3i           | (C96)  | 93 → 98   |                                   |  | 951 409   | 952 405   |
| Wira 1.5i           | (C97)  | 93 → 98   |                                   |  | 951 409   | 952 405   |
| Wira 1.6i 16V       | (C98)  | 93 → 98   | <del>ABS</del>                    |  | 951 409   | 952 405   |
| Wira 1.6i 16V       | (C98)  | 93 → 98   | ABS                               |  | 951 409   | 952 551   |
| Wira 1.8i           | (C99)  | 95 → 98   | ABS                               |  | 951 409   | 952 551   |

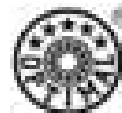



## BEMERKUNGEN/REMARKS/ REMARQUES



| MODELL/MODEL/MODELE          |  |               |                        |  |                 |
|------------------------------|--|---------------|------------------------|--|-----------------|
| Avantime                     |  | 01 → 05       |                        |  | 701 852 702 866 |
| Clio I (B57A)                |  | 91 → 04/97    | <del>ABS</del>         |  | 701 302 702 312 |
| Clio 1.1, 1.2, 1.4           |  | - → 03/94     |                        |  | 04-P161 -       |
| Clio I (B57A)                |  | 94 → 04/97    | ABS                    |  | 700 310 702 352 |
| Clio 1.8, 1.9                |  | - → 03/94     |                        |  | 04-P163 -       |
| Clio I (B57A)                |  | 05/97 → 98    | <del>ABS</del>         |  | 701 302 702 312 |
| Clio 1.2, 1.4                |  | 04/94 → 03/98 |                        |  | 04-P161 -       |
| Clio I (B57A)                |  | 05/97 → 98    | ABS                    |  | 701 302 702 352 |
| Clio 1.2 Ice, 1.2 RL, 1.2 RN |  | 04/96 → 03/98 |                        |  | 04-P161 -       |
| Clio I (B57B)                |  | 90 → 04/97    | <del>ABS</del>         |  | 701 302 702 312 |
| Clio 1.2                     |  | 04/98 → -     |                        |  | 04-P161 -       |
| Clio I (B57B)                |  | 93 → 04/97    | ABS                    |  | 700 310 702 352 |
| Clio 1.4                     |  | 04/94 → 03/98 | ABS                    |  | 04-P163 -       |
| Clio I (B57B)                |  | 05/97 → 98    | <del>ABS</del> Aut.GBX |  | 700 310 702 312 |
| Clio 1.4, 1.6                |  | 04/98 → -     |                        |  | 04-P163 -       |
| Clio I (B57B)                |  | 05/97 → 98    | ABS Aut.GBX            |  | 700 310 702 352 |
| Clio 1.4, 1.8                |  | 04/96 → 03/98 |                        |  | 04-P163 -       |
| Clio I (B57B/RL,RN,RT)       |  | 05/97 → 98    | <del>ABS</del>         |  | 701 302 702 312 |
| Clio 1.8                     |  | 91 → -        | ABS                    |  | 04-P161 -       |
| Clio I (B57B/RL,RN,RT)       |  | 05/97 → 98    | ABS                    |  | 701 302 702 352 |
| Clio 1.8,1.9 D               |  | 04/94 → 03/98 |                        |  | 04-P163 -       |
| Clio I (B57B/S)              |  | 05/97 → 98    | <del>ABS</del>         |  | 700 310 702 312 |
| Clio I (B57B/S)              |  | 05/97 → 98    | ABS                    |  | 700 310 702 352 |
| Clio I (B57C)                |  | 91 → 04/97    | <del>ABS</del> AC      |  | 701 302 702 312 |
| Clio I (B57C)                |  | 91 → 04/97    | <del>ABS</del> AC      |  | 701 302 702 352 |
| Clio I (B57C)                |  | 91 → 04/97    | ABS                    |  | 701 346 702 352 |
| Clio I (B57C)                |  | 05/97 → 98    | <del>ABS</del> AC      |  | 701 346 702 312 |
| Clio I (B57C)                |  | 05/97 → 98    | <del>ABS</del> AC      |  | 701 346 702 352 |
| Clio I (B57C)                |  | 05/97 → 98    | ABS                    |  | 701 346 702 352 |
| Clio I (B57I)                |  | 93 → 98       | <del>ABS</del>         |  | 700 310 702 312 |
| Clio I (B57I)                |  | 94 → 98       | ABS                    |  | 700 310 702 352 |
| Clio I (B57J)                |  | 96 → 04/97    | <del>ABS</del>         |  | 701 302 702 312 |
| Clio I (B57J)                |  | 96 → 04/97    | ABS                    |  | 700 310 702 352 |
| Clio I (B57J)                |  | 05/97 → 98    | <del>ABS</del> Aut.GBX |  | 700 310 702 312 |
| Clio I (B57J)                |  | 05/97 → 98    | ABS Aut.GBX            |  | 700 310 702 352 |
| Clio I (B57J/RN,RT,RL)       |  | 05/97 → 98    | <del>ABS</del>         |  | 701 302 702 312 |
| Clio I (B57J/RN,RT,RL)       |  | 05/97 → 98    | ABS                    |  | 701 302 702 352 |
| Clio I (B57J/INITIALE,S)     |  | 05/97 → 98    | <del>ABS</del>         |  | 700 310 702 312 |
| Clio I (B57J/INITIALE,S)     |  | 05/97 → 98    | ABS                    |  | 700 310 702 352 |
| Clio I (B57L)                |  | 91 → 98       | <del>ABS</del>         |  | 701 346 702 312 |
| Clio I (B57L)                |  | 94 → 98       | ABS                    |  | 701 346 702 352 |
| Clio I (B57N)                |  | 92 → 98       |                        |  | 701 346 702 312 |
| Clio I (B57P)                |  | 91 → 98       |                        |  | 701 346 702 312 |
| Clio I (B57R)                |  | 91 → 96       |                        |  | 701 302 702 312 |
| Clio I (B57S)                |  | 94 → 96       | <del>ABS</del>         |  | 701 302 702 312 |
| Clio I (B57S)                |  | 94 → 96       | ABS                    |  | 700 310 702 352 |
| Clio I (B57T)                |  | 91 → 96       | <del>ABS</del>         |  | 701 302 702 312 |
| Clio I (B57T)                |  | 93 → 96       | ABS                    |  | 700 310 702 352 |
| Clio I (B57U)                |  | 92 → 96       | <del>ABS</del>         |  | 701 302 702 312 |
| Clio I (B57U)                |  | 92 → 96       | ABS                    |  | 701 346 702 352 |
| Clio I (B57Y)                |  | 94 → 04/97    | <del>ABS</del>         |  | 701 302 702 312 |
| Clio I (B57Y)                |  | 94 → 04/97    | ABS                    |  | 700 310 702 352 |
| Clio I (B57Y)                |  | 05/97 → 98    | <del>ABS</del>         |  | 701 302 702 312 |
| Clio I (B57Y)                |  | 05/97 → 98    | ABS                    |  | 701 302 702 352 |





















































| MODELL/MODEL/MODELE |                    |  | BEMERKUNGEN/REMARKS/<br>REMARQUES |  |  |
|---------------------|--------------------|---|-----------------------------------|---|---|
| Clio I              | (B571, B572, B573) | 90 → 96   |                                   | 701 302   | 702 312   |
| Clio I              | (B574)             | 91 → 96   | <del>ABS</del> Ch.→901231         | 701 346   | 702 312   |
| Clio I              | (B574)             | 91 → 96   | <del>ABS</del> Ch.901232→         | 701 302   | 702 312   |
| Clio I              | (B574)             | 91 → 96   | ABS                               | 701 346   | 702 352   |
| Clio I              | (B576)             | 90 → 96   |                                   | 701 346   | 702 312   |
| Clio I              | (B577)             | 94 → 96   |                                   | 701 302   | 702 312   |
| Clio I              | (B578)             | 94 → 98   |                                   | 700 310   | 702 352   |
| Clio I              | (557A)             | 94 → 98   |                                   | 700 310   | 702 352   |
| Clio I              | (557B)             | 94 → 04/97  |                                   | 701 302   | 702 312   |
| Clio I              | (557B)             | 05/97 → 98  |                                   | 700 310   | 702 312   |
| Clio I              | (557D)             | 94 → 96   |                                   | 700 310   | 702 352   |
| Clio I              | (557F)             | 94 → 96   |                                   | 701 302   | 702 312   |
| Clio I              | (557G)             | 94 → 96   | <del>ABS</del>                    | 701 302   | 702 312   |
| Clio I              | (557G)             | 94 → 96   | ABS                               | 700 310   | 702 352   |
| Clio I              | (557J)             | 94 → 96   | <del>ABS</del>                    | 701 302   | 702 312   |
| Clio I              | (557J)             | 94 → 96   | ABS                               | 700 310   | 702 352   |
| Clio I              | (557K)             | 96 → 04/97  | <del>ABS</del>                    | 701 302   | 702 312   |
| Clio I              | (557K)             | 96 → 04/97  | ABS                               | 700 310   | 702 352   |
| Clio I              | (557K)             | 05/97 → 98  | <del>ABS</del>                    | 701 302   | 702 312   |
| Clio I              | (557K)             | 05/97 → 98  | ABS                               | 701 302   | 702 352   |
| Clio I              | (557L)             | 94 → 96   |                                   | 701 302   | 702 312   |
| Clio I              | (557N)             | 96 → 98   | <del>ABS</del>                    | 700 310   | 702 312   |
| Clio I              | (557N)             | 96 → 98   | ABS                               | 700 310   | 702 352   |
| Clio I              | (557R)             | 96 → 04/97  | <del>ABS</del>                    | 701 302   | 702 312   |
| Clio I              | (557R)             | 96 → 04/97  | ABS                               | 700 310   | 702 352   |
| Clio I              | (557R)             | 05/97 → 98  | <del>ABS</del>                    | 701 302   | 702 312   |
| Clio I              | (557R)             | 05/97 → 98  | ABS                               | 701 302   | 702 352   |
| Clio I              | (557U)             | 96 → 04/97  | <del>ABS AC</del>                 | 701 302   | 702 312   |
| Clio I              | (557U)             | 96 → 04/97  | <del>ABS AC</del>                 | 701 302   | 702 352   |
| Clio I              | (557U)             | 96 → 04/97  | ABS                               | 700 310   | 702 352   |
| Clio I              | (557U)             | 96 → 04/97  | <del>ABS AC</del> Aut.GBX         | 700 310   | 702 312   |
| Clio I              | (557U)             | 96 → 04/97  | <del>ABS AC</del> Aut.GBX         | 700 310   | 702 352   |
| Clio I              | (557U)             | 96 → 04/97  | ABS Aut.GBX                       | 700 310   | 702 352   |
| Clio I              | (557U)             | 05/97 → 98  | <del>ABS AC</del>                 | 700 310   | 702 312   |
| Clio I              | (557U)             | 05/97 → 98  | <del>ABS AC</del>                 | 700 310   | 702 352   |
| Clio I              | (557U)             | 05/97 → 98  | ABS                               | 700 310   | 702 352   |
| Clio I              | (557W)             | 95 → 04/97  |                                   | 701 302   | 702 309   |
| Clio I              | (557W)             | 05/97 → 98  |                                   | 700 310   | 702 309   |
| Clio I              | (557Y)             | 96 → 04/97  | <del>ABS</del>                    | 701 302   | 702 312   |
| Clio I              | (557Y)             | 96 → 04/97  | ABS                               | 700 310   | 702 352   |
| Clio I              | (557Y)             | 05/97 → 98  | <del>ABS</del>                    | 701 302   | 702 312   |
| Clio I              | (557Y)             | 05/97 → 98  | ABS                               | 701 302   | 702 352   |
| Clio I              | (C57A)             | 91 → 04/97  | <del>ABS</del>                    | 701 302   | 702 312   |
| Clio I              | (C57A)             | 94 → 04/97  | ABS                               | 700 310   | 702 352   |
| Clio I              | (C57A)             | 05/97 → 98  | <del>ABS</del>                    | 701 302   | 702 312   |
| Clio I              | (C57A)             | 05/97 → 98  | ABS                               | 701 302   | 702 352   |
| Clio I              | (C57B)             | 90 → 04/97  | <del>ABS</del>                    | 701 302   | 702 312   |
| Clio I              | (C57B)             | 93 → 04/97  | ABS                               | 700 310   | 702 352   |
| Clio I              | (C57B)             | 05/97 → 98  | <del>ABS</del> Aut.GBX            | 700 310   | 702 312   |
| Clio I              | (C57B)             | 05/97 → 98  | ABS Aut.GBX                       | 700 310   | 702 352   |
| Clio I              | (C57B/RN,RT)       | 05/97 → 98  | <del>ABS</del>                    | 701 302   | 702 312   |
| Clio I              | (C57B/RN,RT)       | 05/97 → 98  | ABS                               | 701 302   | 702 352   |
| Clio I              | (C57B/RTI,S)       | 05/97 → 98  | <del>ABS</del>                    | 700 310   | 702 312   |
| Clio I              | (C57B/RTI,S)       | 05/97 → 98  | ABS                               | 700 310   | 702 352   |

**MODELL/MODEL/MODELE**









































**BEMERKUNGEN/REMARKS/  
REMARQUES**

|        |              |            |                            |         |         |
|--------|--------------|------------|----------------------------|---------|---------|
| Clio I | (C57C)       | 92 → 04/97 | <del>ABS</del>             | 701 302 | 702 312 |
| Clio I | (C57C)       | 92 → 04/97 | ABS                        | 701 346 | 702 352 |
| Clio I | (C57C)       | 05/97 → 98 | <del>ABS</del>             | 700 310 | 702 312 |
| Clio I | (C57C)       | 05/97 → 98 | ABS                        | 700 310 | 702 352 |
| Clio I | (C57D)       | 91 → 96    |                            | 700 310 | 702 352 |
| Clio I | (C57H)       | 94 → 04/97 | <del>ABS</del>             | 701 302 | 702 352 |
| Clio I | (C57H)       | 94 → 04/97 | ABS                        | 700 310 | 702 352 |
| Clio I | (C57H)       | 05/97 → 98 |                            | 700 310 | 702 352 |
| Clio I | (C57I)       | 93 → 98    | <del>ABS</del>             | 700 310 | 702 312 |
| Clio I | (C57I)       | 93 → 98    | ABS                        | 700 310 | 702 352 |
| Clio I | (C57J)       | 96 → 04/97 | <del>ABS</del>             | 701 302 | 702 312 |
| Clio I | (C57J)       | 96 → 04/97 | ABS                        | 700 310 | 702 352 |
| Clio I | (C57J)       | 05/97 → 98 | <del>ABS</del> Aut.GBX     | 700 310 | 702 312 |
| Clio I | (C57J)       | 05/97 → 98 | ABS Aut.GBX                | 700 310 | 702 352 |
| Clio I | (C57J/RL,RT) | 05/97 → 98 | <del>ABS</del>             | 701 302 | 702 312 |
| Clio I | (C57J/RL,RT) | 05/97 → 98 | ABS                        | 701 302 | 702 352 |
| Clio I | (C57J/RTI,S) | 05/97 → 98 | <del>ABS</del>             | 700 310 | 702 312 |
| Clio I | (C57J/RTI,S) | 05/97 → 98 | ABS                        | 700 310 | 702 352 |
| Clio I | (C57L)       | 91 → 98    | <del>ABS</del>             | 701 346 | 702 312 |
| Clio I | (C57L)       | 91 → 98    | ABS                        | 701 346 | 702 352 |
| Clio I | (C57M)       | 94 → 96    |                            | 700 310 | 702 352 |
| Clio I | (C57R)       | 91 → 96    |                            | 701 302 | 702 312 |
| Clio I | (C57S)       | 94 → 96    | <del>ABS</del>             | 701 302 | 702 312 |
| Clio I | (C57S)       | 94 → 96    | ABS                        | 700 310 | 702 352 |
| Clio I | (C57T)       | 91 → 96    | <del>ABS</del>             | 701 302 | 702 312 |
| Clio I | (C57T)       | 93 → 96    | ABS                        | 700 310 | 702 352 |
| Clio I | (C57U)       | 92 → 96    | <del>ABS</del>             | 701 302 | 702 312 |
| Clio I | (C57U)       | 92 → 96    | ABS                        | 701 346 | 702 352 |
| Clio I | (C57Y)       | 94 → 04/97 | <del>ABS</del>             | 701 302 | 702 312 |
| Clio I | (C57Y)       | 94 → 04/97 | ABS                        | 700 310 | 702 352 |
| Clio I | (C57Y/RN,RT) | 05/97 → 98 | <del>ABS</del>             | 701 302 | 702 312 |
| Clio I | (C57Y/RN,RT) | 05/97 → 98 | ABS                        | 701 302 | 702 352 |
| Clio I | (C57Y/RTI)   | 05/97 → 98 | <del>ABS</del>             | 700 310 | 702 312 |
| Clio I | (C57Y/RTI)   | 05/97 → 98 | ABS                        | 700 310 | 702 352 |
| Clio I | (C571)       | 93 → 96    |                            | 701 302 | 702 312 |
| Clio I | (C572, C573) | 90 → 96    |                            | 701 302 | 702 312 |
| Clio I | (C574)       | 91 → 96    | <del>ABS</del> Ch.->901231 | 701 346 | 702 312 |
| Clio I | (C574)       | 91 → 96    | <del>ABS</del> Ch.901232-> | 701 302 | 702 312 |
| Clio I | (C574)       | 94 → 96    | ABS                        | 701 346 | 702 352 |
| Clio I | (C575)       | 90 → 96    |                            | 700 310 | 702 352 |
| Clio I | (C576)       | 90 → 96    |                            | 701 346 | 702 312 |
| Clio I | (C577)       | 94 → 96    |                            | 701 302 | 702 312 |
| Clio I | (C578)       | 94 → 98    |                            | 700 310 | 702 352 |
| Clio I | (C579)       | 93 → 96    | <del>ABS</del>             | 701 302 | 702 352 |
| Clio I | (C579)       | 93 → 96    | ABS                        | 700 310 | 702 352 |
| Clio I | (S57A)       | 92 → 98    |                            | 701 302 | 702 312 |
| Clio I | (S57I)       | 93 → 98    |                            | 700 310 | 702 312 |
| Clio I | (S57L)       | 91 → 98    |                            | 701 346 | 702 312 |
| Clio I | (S57R)       | 92 → 98    |                            | 701 302 | 702 312 |
| Clio I | (S571)       | 93 → 96    |                            | 701 302 | 702 312 |
| Clio I | (S572)       | 91 → 96    |                            | 701 302 | 702 312 |
| Clio I | (S576)       | 91 → 96    |                            | 701 346 | 702 312 |
| Clio I | (S577)       | 94 → 96    |                            | 701 302 | 702 312 |
| Clio I | (357A)       | 94 → 98    |                            | 700 310 | 702 352 |

| MODELL/MODEL/MODELE     |                |  | BEMERKUNGEN/REMARKS/<br>REMARQUES  |  |  |
|-------------------------|----------------|---|--|---|---|
| Clio I                  | (357D)         | 94 → 96   |  | 700 310   | 702 352   |
| Clio I                  | (357E)         | 94 → 96   | <del>ABS</del>   | 701 302   | 702 352   |
| Clio I                  | (357E)         | 94 → 96   | ABS  | 700 310   | 702 352   |
| Clio I                  | (357F)         | 94 → 96   |  | 701 302   | 702 312   |
| Clio I                  | (357G, 357J)   | 94 → 96   | <del>ABS</del>   | 701 302   | 702 312   |
| Clio I                  | (357G, 357J)   | 94 → 96   | ABS  | 700 310   | 702 352   |
| Clio I                  | (357K)         | 96 → 04/97  | <del>ABS</del>   | 701 302   | 702 312   |
| Clio I                  | (357K)         | 96 → 04/97  | ABS  | 700 310   | 702 352   |
| Clio I                  | (357K)         | 05/97 → 98  | <del>ABS</del>   | 701 302   | 702 312   |
| Clio I                  | (357K)         | 05/97 → 98  | ABS  | 701 302   | 702 352   |
| Clio I                  | (357L)         | 94 → 96   |  | 701 302   | 702 312   |
| Clio I                  | (357N)         | 96 → 98   | <del>ABS</del>   | 700 310   | 702 312   |
| Clio I                  | (357N)         | 96 → 98   | ABS  | 700 310   | 702 352   |
| Clio I                  | (357R)         | 96 → 04/97  | <del>ABS</del>   | 701 302   | 702 312   |
| Clio I                  | (357R)         | 96 → 04/97  | ABS  | 700 310   | 702 352   |
| Clio I                  | (357R/RN,RL)   | 05/97 → 98  | <del>ABS</del>   | 701 302   | 702 312   |
| Clio I                  | (357R/RN,RL)   | 05/97 → 98  | ABS  | 701 302   | 702 352   |
| Clio I                  | (357U)         | 96 → 04/97  | <del>ABS AC</del>  | 701 302   | 702 312   |
| Clio I                  | (357U)         | 96 → 04/97  | <del>ABS AC</del>  | 701 302   | 702 352   |
| Clio I                  | (357U)         | 96 → 04/97  | ABS  | 700 310   | 702 352   |
| Clio I                  | (357U)         | 96 → 04/97  | <del>ABS AC</del> Aut.GBX  | 700 310   | 702 312   |
| Clio I                  | (357U)         | 96 → 04/97  | <del>ABS AC</del> Aut.GBX  | 700 310   | 702 352   |
| Clio I                  | (357U)         | 96 → 04/97  | ABS Aut.GBX  | 700 310   | 702 352   |
| Clio I                  | (357U)         | 05/97 → 98  | <del>ABS AC</del>  | 700 310   | 702 312   |
| Clio I                  | (357U)         | 05/97 → 98  | <del>ABS AC</del>  | 700 310   | 702 352   |
| Clio I                  | (357U)         | 05/97 → 98  | ABS  | 700 310   | 702 352   |
| Clio I                  | (357V)         | 96 → 04/97  | <del>ABS</del>   | 701 302   | 702 352   |
| Clio I                  | (357V)         | 96 → 04/97  | ABS  | 700 310   | 702 352   |
| Clio I                  | (357V)         | 04/97 → 98  |  | 700 310   | 702 352   |
| Clio I                  | (357Y)         | 96 → 04/97  | <del>ABS</del>   | 701 302   | 702 312   |
| Clio I                  | (357Y)         | 96 → 04/97  | ABS  | 700 310   | 702 352   |
| Clio I                  | (357Y)         | 05/97 → 98  | <del>ABS</del>   | 701 302   | 702 312   |
| Clio I                  | (357Y)         | 05/97 → 98  | ABS  | 701 302   | 702 352   |
| Clio I                  | (657H)         | 96 → 98   |  | 700 310   | 702 312   |
| Clio I                  | (657K)         | 96 → 98   |  | 701 302   | 702 312   |
| Clio I                  | (657M, 657N)   | 96 → 98   |  | 700 310   | 702 312   |
| Clio I                  | (657W)         | 96 → 04/97  |  | 701 302   | 702 309   |
| Clio I                  | (657W)         | 05/97 → 98  |  | 700 310   | 702 309   |
| Clio II                 |                | 98 → 05   | {Front  35x65x35} {Rear  } | 701 302   | 702 312   |
| Clio II                 |                | 98 → 05   | {Front  37x72x37} {Rear  } | 700 310   | 702 352   |
| Clio II RS 3.0 V6 Sport |                | 00 → 05   | ABS - Active Sensor Bearing  | 701 975   | 701 975   |
| Clio III                | (BR0/1, CR0/1) | 06/05 → 06  | {Rear  }  | 701 977   | 702 982   |
| Clio III                | (BR0/1, CR0/1) | 06/05 → 06  | {Rear  }  | 701 977   | 702 312   |
| Espace I 2.0            | (J112, S112)   | 85 → 90   |  | 701 326   | 702 380   |
| Espace                  |                | 84 → -  | V6   | 04-P165   | -   |
| Espace I 2.0 4x4        | (J112, S112)   | 85 → 90   |  | 701 326   | 700 310   |
| Espace I 2.1 Diesel     | (J115)         | 85 → 90   | <del>Level adj.</del>  | 701 326   | 702 380   |
| Espace I 2.1 Diesel     | (J115)         | 85 → 90   | Level adj.   | 701 326   | 702 514   |
| Espace I 2.1 Diesel     | (S115)         | 85 → 90   |  | 701 326   | 702 514   |
| Espace I 2.2            | (J116, J117)   | 87 → 90   | <del>ABS Level adj.</del>  | 701 326   | 702 380   |
| Espace I 2.2            | (J116, J117)   | 87 → 90   | <del>ABS Level adj.</del>  | 701 326   | 702 514   |
| Espace I 2.2            | (J116, J117)   | 87 → 90   | ABS  | 701 326   | 702 514   |
| Espace I 2.2 4x4        | (J116, J117)   | 87 → 90   |  | 701 326   | 700 310   |
| Espace II 2.0           | (J636)         | 91 → 10/96  |   | 701 326   | 702 452   |

| MODELL/MODEL/MODELE                         |                    |  | BEMERKUNGEN/REMARKS/<br>REMARQUES   |  |  |
|---|--------------------|---|---|---|---|
| Espace II 2.0                               | (J636)             | 91 → 10/96  |    | 701 326   | 702 514   |
| Espace II 2.1 Diesel                        | (J63D/E, S63D)     | 91 → 10/96  |    | 701 326   | 702 452   |
| Espace II 2.1 Diesel                        | (J63D/E, S63D)     | 91 → 10/96  |    | 701 326   | 702 514   |
| Espace II 2.1 Diesel                        | (J633/4/5, S635)   | 91 → 10/96  |    | 701 326   | 702 452   |
| Espace II 2.1 Diesel                        | (J633/4/5, S635)   | 91 → 10/96  |    | 701 326   | 702 514   |
| Espace II 2.1 Diesel 4x4                    | (J635)             | 91 → 94   |   | 701 326   | 702 363   |
| Espace II 2.2                               | (J63G, J637, S637) | 91 → 10/96  |    | 701 326   | 702 452   |
| Espace II 2.2                               | (J63G, J637, S637) | 91 → 10/96  |    | 701 326   | 702 514   |
| Espace II 2.2 4x4                           | (J637)             | 91 → 10/96  |   | 701 326   | 702 363   |
| Espace II 2.8 V6                            | (J63J, J638)       | 91 → 10/96  |  ABS   | 701 326   | 702 537   |
| Espace II 2.8 V6                            | (J63J, J638)       | 91 → 10/96  |  ABS   | 701 326   | 702 365   |
| Espace III                                  | (JE..)             | 11/96 → 11/02   | <del>ABS</del>  | 701 852   | 702 537   |
| Espace III                                  | (JE..)             | 11/96 → 11/02   | ABS   | 701 852   | 702 866   |
| Espace IV                                   |                    | 11/02 → 06  |  ABS - Active Sensor Bearing {Rear:  with brake disc}     | 701 247   | 702 899   |
| Fuego 1.4 TL/GTL                            |                    | 80 → 85   |   | 701 326   | 702 328   |
| Fuego 1.6 TS/GTS                            |                    | 80 → 06/84  | Ch.→61220   | 701 326   | 702 350   |
| Fuego 1.6 TS/GTS                            |                    | 07/84 → 85  | Ch.61221→   | 701 326   | 702 380   |
| Fuego 1.6 Turbo                             |                    | 80 → 85   |   | 701 326   | 702 452   |
| Fuego 1.8 TX/GTX                            |                    | 80 → 06/84  | Ch.→61220   | 701 326   | 702 350   |
| Fuego 1.8 TX/GTX                            |                    | 07/84 → 85  | Ch.61221→   | 701 326   | 702 380   |
| Fuego Turbo Diesel                          |                    | 80 → 84   | Ch.→61220   | 701 326   | 702 350   |
| Fuego Turbo Diesel                          |                    | 85 → 85   | Ch.61221→   | 701 326   | 702 380   |
| Kangoo                                      |                    | 98 → 05   |   | 700 310   | 702 426   |
| Kangoo                                      |                    | 98 → -  |   | 04-P163   | -   |
| Kangoo                                      |                    | 98 → 02/03  |  26  | 700 310   | 702 850   |
| Kangoo                                      |                    | 03/03 → 05/05   |  44  | 700 310   | -   |
| Kangoo 4x4                                  |                    | 01 → 05   |   | 700 245   | 700 245   |
| Laguna I                                    | Front              | 93 → 98   |  37x72x37 <del>ABS</del>   | 700 310   | -   |
| Laguna                                      |                    | 93 → -  |   | 04-P167   | -   |
| Laguna I                                    | Front              | 93 → 98   |  40x84x38 <del>ABS</del> ABS   | 701 307   | -   |
| Laguna I                                    | Front              | 97 → 98   |  40x84x39,7 ABS - Active Sensor Bearing  | 701 914   | -   |
| Laguna I                                    | Front              | 99 → 03/01  |  40x84x39,7 ABS - Active Sensor Bearing  | 701 914   | -   |
| Laguna I Hatchback                          | Rear               | 93 → 03/01  |    | -   | 702 426   |
| Laguna I Hatchback                          | Rear               | 93 → 02/97  |  x5  | -   | 702 355   |
| Laguna I Hatchback                          | Rear               | 93 → 02/97  |  x4  | -   | 702 357   |
| Laguna I Hatchback                          | Rear               | 02/97 → 09/99   |  x5 ABS - Active Sensor Bearing  | -   | 702 958   |
| Laguna I Hatchback                          | Rear               | 09/99 → 03/01   |  x4 ABS - Active Sensor Bearing  | -   | 702 957   |
| Laguna I Grandtour                          | Rear               | 93 → 03/01  |  x4 <del>ABS</del>   | -   | 702 353   |
| Laguna I Grandtour                          | Rear               | 93 → 03/01  |  x4 ABS  | -   | 702 351   |
| Laguna I Grandtour                          | Rear               | 93 → 02/97  |  x5 <del>ABS</del>   | -   | 702 915   |
| Laguna I Grandtour                          | Rear               | 93 → 02/97  |  x5 ABS  | -   | 702 359   |
| Laguna I Grandtour                          | Rear               | 93 → 02/97  |  x4 <del>ABS</del>   | -   | 702 353   |
| Laguna I Grandtour                          | Rear               | 93 → 02/97  |  x4 ABS  | -   | 702 351   |
| Laguna I Grandtour                          | Rear               | 02/97 → 09/99   |  x5 ABS - Active Sensor Bearing  | -   | 702 960   |
| Laguna I Grandtour                          | Rear               | 09/99 → 03/01   |  x4 ABS - Active Sensor Bearing  | -   | 702 959   |
| Laguna II                                   |                    | 03/01 → 06  |  ABS - Active Sensor Bearing {Rear:  with brake disc} | 701 975   | 702 976   |
| Megane I Hatchback 1.4, 1.6, 1.8            | (BA_)              | 95 → 04   |    | 700 310   | 702 312   |
| Megane 1.4, 1.6                             |                    | 04/99 → -   |   | 04-P163   | -   |
| Megane I Hatchback 1.4, 1.6, 1.8            | (BA_)              | 95 → 04   |    | 700 310   | 702 352   |
| Megane 1.4, 1.6, 1.9 D, 1.9 TD              |                    | - → 03/99   |   | 04-P163   | -   |
| Megane I Hatchback 1.9 D, 1.9 dT            | (BA_)              | 95 → 04   |    | 700 310   | 702 312   |
| Megane Scenic 1.6 RXT, 1.6 RXE 1.9, 2.0     |                    | 04/99 → -   |   | 04-P169   | -   |
| Megane 2.0 Classic RT, 2.0 Coach RT, 2.0 RT |                    | - → 03/99   |   | 04-P163   | -   |
| Megane I Hatchback 1.9 D, 1.9 dT            | (BA_)              | 95 → 04   |    | 700 310   | 702 352   |



| MODELL/MODEL/MODELE                       |  | BEMERKUNGEN/REMARKS/<br>REMARQUES   |  |  |
|---|---|---|---|---|
| Megane 2.0 Coach RT 16V, 1.9 dt Scenic RT | - → 03/99   |   | 04-P167   | -   |
| Megane I Hatchback 1.9 dTi, 1.9 dCi (BA_) | 95 → 04   |    | 700 310   | 702 312   |
| Megane I Hatchback 1.9 dTi, 1.9 dCi (BA_) | 95 → 04   |    | 700 310   | 702 352   |
| Megane I Hatchback 2.0i (BA_)             | 95 → 04   |    | 700 310   | 702 312   |
| Megane I Hatchback 2.0i (BA_)             | 95 → 04   |    | 700 310   | 702 352   |
| Megane I Hatchback 2.0 16V (BA0H)         | 95 → 09/98  |    | 701 307   | 702 312   |
| Megane I Hatchback 2.0 16V (BA0H)         | 95 → 09/98  |    | 701 307   | 702 352   |
| Megane I Hatchback 2.0 16V (BA0H)         | 10/98 → 04  |    | 700 310   | 702 312   |
| Megane I Hatchback 2.0 16V (BA0H)         | 10/98 → 04  |    | 700 310   | 702 352   |
| Megane I Grandtour (KA0_)                 | 98 → 04   |  ABS                                     | 700 310   | 702 452   |
| Megane I Grandtour (KA0_)                 | 98 → 04   |  ABS                                     | 700 310   | 702 321   |
| Megane I Grandtour (KA0_)                 | 99 → 04   |  {Rear: Wheel bearing with brake disc}   | 700 310   | -   |
| Megane I Cabriolet 1.4, 1.6, 2.0 (EA_)    | 95 → 02   |    | 700 310   | 702 312   |
| Megane I Cabriolet 1.4, 1.6, 2.0 (EA_)    | 95 → 02   |    | 700 310   | 702 352   |
| Megane I Cabriolet 2.0 16V (EA0H)         | 95 → 09/98  |    | 701 307   | 702 312   |
| Megane I Cabriolet 2.0 16V (EA0H)         | 95 → 09/98  |    | 701 307   | 702 352   |
| Megane I Cabriolet 2.0 16V (EA0H)         | 10/98 → 02  |    | 700 310   | 702 312   |
| Megane I Cabriolet 2.0 16V (EA0H)         | 10/98 → 02  |    | 700 310   | 702 352   |
| Megane I Classic (LA_)                    | 95 → 04   |    | 700 310   | 702 312   |
| Megane I Classic (LA_)                    | 95 → 04   |   | 700 310   | 702 352   |
| Megane I Coupé 1.4, 1.6, 2.0i (DA_)       | 95 → 02   |                                        | 700 310   | 702 312   |
| Megane I Coupé 1.4, 1.6, 2.0i (DA_)       | 95 → 02   |                                        | 700 310   | 702 352   |
| Megane I Coupé 1.9 dTi, 1.9 dCi (DA_)     | 95 → 02   |                                        | 700 310   | 702 312   |
| Megane I Coupé 1.9 dTi, 1.9 dCi (DA_)     | 95 → 02   |                                        | 700 310   | 702 352   |
| Megane I Coupé 2.0 16V (DA0H)             | 95 → 09/98  |                                        | 701 307   | 702 312   |
| Megane I Coupé 2.0 16V (DA0H)             | 95 → 09/98  |                                        | 701 307   | 702 352   |
| Megane I Coupé 2.0 16V (DA0H)             | 10/98 → 02  |                                        | 700 310   | 702 312   |
| Megane I Coupé 2.0 16V (DA0H)             | 10/98 → 02  |                                        | 700 310   | 702 352   |
| Megane II Hatchback 1.4i 16V (BM_, CM_)   | 03 → 06   | ABS - Active Sensor Bearing   | 701 977   | 702 982   |
| Megane II Hatchback 1.5 dCi (BM_, CM_)    | 03 → 06   | ABS - Active Sensor Bearing   | 701 977   | 702 982   |
| Megane II Hatchback 1.6i 16V (BM_, CM_)   | 03 → 06   | ABS - Active Sensor Bearing   | 701 977   | 702 982   |
| Megane II Hatchback 1.9 dCi (BM_, CM_)    | 03 → 06   | ABS - Active Sensor Bearing   | 701 978   | 702 982   |
| Megane II Hatchback 2.0i 16V (BM_, CM_)   | 03 → 06   | ABS - Active Sensor Bearing   | 701 977   | 702 982   |
| Megane II Sedan 1.4i 16V (LM0/1)          | 03 → 06   | ABS - Active Sensor Bearing   | 701 977   | 702 982   |
| Megane II Sedan 1.5 dCi (LM0/1)           | 03 → 06   | ABS - Active Sensor Bearing   | 701 977   | 702 982   |
| Megane II Sedan 1.6i 16V (LM0/1)          | 03 → 06   | ABS - Active Sensor Bearing   | 701 977   | 702 982   |
| Megane II Sedan 1.9 dCi (LM0/1)           | 03 → 06   | ABS - Active Sensor Bearing   | 701 978   | 702 982   |
| Megane II Sedan 2.0i 16V (LM0/1)          | 03 → 06   | ABS - Active Sensor Bearing   | 701 977   | 702 982   |
| Megane II Cabriolet 1.4i 16V (EM0/1)      | 03 → 06   | ABS - Active Sensor Bearing   | 701 977   | 702 982   |
| Megane II Cabriolet 1.5 dCi (EM0/1)       | 03 → 06   | ABS - Active Sensor Bearing   | 701 977   | 702 982   |
| Megane II Cabriolet 1.6i 16V (EM0/1)      | 03 → 06   | ABS - Active Sensor Bearing   | 701 977   | 702 982   |
| Megane II Cabriolet 1.9 dCi (EM0/1)       | 03 → 06   | ABS - Active Sensor Bearing   | 701 978   | 702 982   |
| Megane II Cabriolet 2.0i 16V (EM0/1)      | 03 → 06   | ABS - Active Sensor Bearing   | 701 977   | 702 982   |
| Megane II Break 1.4i 16V (KM_)            | 03 → 06   |  ABS - Active Sensor Bearing           | 701 977   | 702 983   |
| Megane II Break 1.5 dCi (KM_)             | 03 → 06   |  ABS - Active Sensor Bearing           | 701 977   | 702 983   |
| Megane II Break 1.6i 16V (KM_)            | 03 → 06   |  ABS - Active Sensor Bearing           | 701 977   | 702 983   |
| Megane II Break 1.9 dCi (KM_)             | 03 → 06   |  ABS - Active Sensor Bearing           | 701 978   | 702 983   |
| Megane II Break 2.0i 16V (KM_)            | 03 → 06   |  ABS - Active Sensor Bearing           | 701 977   | 702 983   |
| Megane Scenic I 1.4 (JA0E)                | 97 → 09/99  |  ABS                                   | 700 310   | 702 309   |
| Megane Scenic I 1.4 (JA0E)                | 97 → 09/99  |  ABS                                   | 700 310   | 702 321   |
| Megane Scenic I 1.4 (JA_)                 | 09/99 → 04  |  {Rear: Wheel bearing with brake disc} | 700 310   | 702 603   |
| Megane Scenic I 1.6 (JA04)                | 01/98 → 06/98   |  ABS                                   | 701 307   | 702 309   |
| Megane Scenic I 1.6 (JA04)                | 01/98 → 06/98   |  ABS                                   | 701 307   | 702 321   |
| Megane Scenic I 1.6 (JA04)                | 07/98 → 04  |  ABS                                   | 700 310   | 702 309   |

## MODELL/MODEL/MODELE









## BEMERKUNGEN/REMARKS/ REMARQUES



|  |          |               |                                       |         |         |
|--|----------|---------------|---------------------------------------|---------|---------|
| Megane Scenic I 1.6                    | (JA04)   | 07/98 → 04    | ABS                                   | 700 310 | 702 321 |
| Megane Scenic I 1.6                    | (JA0F)   | 97 → 98       | Man.GBX <del>ABS</del>                | 700 310 | 702 309 |
| Megane Scenic I 1.6                    | (JA0F)   | 97 → 98       | Man.GBX ABS                           | 700 310 | 702 321 |
| Megane Scenic I 1.6                    | (JA0F)   | 97 → 06/98    | Aut.GBX <del>ABS</del>                | 701 307 | 702 309 |
| Megane Scenic I 1.6                    | (JA0F)   | 97 → 06/98    | Aut.GBX ABS                           | 701 307 | 702 321 |
| Megane Scenic I 1.6                    | (JA0F)   | 07/98 → 09/99 | Aut.GBX <del>ABS</del>                | 700 310 | 702 309 |
| Megane Scenic I 1.6                    | (JA0F)   | 07/98 → 09/99 | Aut.GBX ABS                           | 700 310 | 702 321 |
| Megane Scenic I 1.6                    | (JA0L)   | 97 → 98       | <del>ABS</del>                        | 700 310 | 702 309 |
| Megane Scenic I 1.6                    | (JA0L)   | 97 → 98       | ABS                                   | 700 310 | 702 321 |
| Megane Scenic I 1.6                    | (JA_)    | 09/99 → 04    | {Rear: Wheel bearing with brake disc} | 700 310 | 702 603 |
| Megane Scenic I 1.8 16V                | (JA_)    | 01 → 04       | {Rear: Wheel bearing with brake disc} | 700 310 | 702 603 |
| Megane Scenic I 1.9 D, 1.9 dT, 1.9 dTi | (JA_)    | 97 → 06/98    | <del>ABS</del>                        | 701 307 | 702 309 |
| Megane Scenic I 1.9 D, 1.9 dT, 1.9 dTi | (JA_)    | 97 → 06/98    | ABS                                   | 701 307 | 702 321 |
| Megane Scenic I 1.9 D, 1.9 dT, 1.9 dTi | (JA_)    | 07/98 → 09/99 | <del>ABS</del>                        | 700 310 | 702 309 |
| Megane Scenic I 1.9 D, 1.9 dT, 1.9 dTi | (JA_)    | 07/98 → 09/99 | ABS                                   | 700 310 | 702 321 |
| Megane Scenic I 1.9 dTi, 1.9 dCi       | (JA_)    | 09/99 → 04    | {Rear: Wheel bearing with brake disc} | 700 310 | 702 603 |
| Megane Scenic I 2.0                    | (JA_)    | 97 → 06/98    | <del>ABS</del>                        | 701 307 | 702 309 |
| Megane Scenic I 2.0                    | (JA_)    | 97 → 06/98    | ABS                                   | 701 307 | 702 321 |
| Megane Scenic I 2.0                    | (JA_)    | 07/98 → 09/99 | <del>ABS</del>                        | 700 310 | 702 309 |
| Megane Scenic I 2.0                    | (JA_)    | 07/98 → 09/99 | ABS                                   | 700 310 | 702 321 |
| Megane Scenic I 2.0                    | (JA_)    | 09/99 → 04    | {Rear: Wheel bearing with brake disc} | 700 310 | 702 603 |
| Megane Scenic I RX4                    | (JA_)    | 97 → 04       |                                       | 700 245 | 700 245 |
| Modus                                  | (F/JP0_) | 12/04 → 06    | {Rear  }                              | 701 977 | 702 982 |
| Modus                                  | (F/JP0_) | 12/04 → 06    | {Rear  }                              | 701 977 | 702 312 |
| R 4                                    |          | - → -         |                                       | 04-P203 | -       |
| R 4                                    |          | 78 → 91       |                                       | 701 374 | 702 328 |
| R 5                                    |          | 78 → 85       |                                       | 701 374 | 702 328 |
| R 5 super                              |          | 72 → 85       |                                       | 04-P161 | -       |
| R 5                                    |          | 62 → 93       |                                       | 04-P203 | -       |
| R 5 Super 1.0, 1.1, 1.2                |          | 87 → 95       |                                       | 701 302 | 702 312 |
| R 5 Super 1.4, 1.4 Turbo               |          | 87 → 93       |                                       | 701 302 | 702 312 |
| R 5 Super 1.4 GT Turbo                 |          | 87 → 93       |                                       | 701 319 | 702 352 |
| R 5 Super 1.6 Diesel                   |          | 87 → 96       |                                       | 701 319 | 702 312 |
| R 5 Super 1.7                          |          | 87 → 93       |                                       | 701 302 | 702 312 |
| R 5 Super 1.7 GT Turbo                 |          | 87 → 93       |                                       | 701 319 | 702 352 |
| R 5 Express 1.0, 1.1                   |          | 85 → 92       | 180 mm                                | 701 302 | 702 316 |
| R 5 Express 1.0, 1.1                   |          | 85 → 92       | 203 mm                                | 701 302 | 702 426 |
| R 5 Express 1.2                        |          | 86 → 98       |                                       | 701 302 | 702 426 |
| R 5 Express 1.2 Extra                  |          | 92 → 94       |                                       | 701 302 | 702 316 |
| R 5 Express 1.4                        |          | 85 → 08/91    |                                       | 701 302 | 702 426 |
| R 5 Express 1.4                        |          | 09/91 → 98    |                                       | 701 302 | 702 426 |
| R 5 Express 1.4                        |          | 09/91 → 98    |                                       | 700 310 | 702 452 |
| R 5 Express 1.6 Diesel                 |          | 86 → 98       | 180 mm                                | 701 319 | 702 316 |
| R 5 Express 1.6 Diesel                 |          | 86 → 98       | 203 mm                                | 701 319 | 702 426 |
| R 5 Express 1.6 Diesel                 |          | 86 → 98       |                                       | 700 310 | 702 452 |
| R 5 Express 1.9 Diesel                 |          | 91 → 98       |                                       | 701 319 | 702 426 |
| R 5 Express 1.9 Diesel                 |          | 91 → 98       |                                       | 700 310 | 702 452 |
| R 6                                    |          | 69 → 87       |                                       | 04-P203 | -       |
| R 9                                    |          | 82 → 89       |                                       | 701 302 | 702 312 |
| R 9                                    |          | 81 → 89       |                                       | 04-P161 | -       |
| R 9 Diesel                             |          | 82 → 89       |                                       | 701 319 | 702 312 |
| R 9 Turbo                              |          | 85 → 89       |                                       | 701 319 | 702 352 |
| R 11                                   |          | 83 → 89       |                                       | 701 302 | 702 312 |
| R 11                                   |          | 83 → 89       |                                       | 04-P161 | -       |





























| MODELL/MODEL/MODELE                |  | BEMERKUNGEN/REMARKS/<br>REMARQUES  |  |  |
|------------------------------------|---|--|---|---|
| R 11 Diesel                        | 83 → 89   |  | 701 319   | 702 312   |
| R 11 Turbo                         | 84 → 89   |  | 701 319   | 702 352   |
| R 12 L, TL (R1170)                 | 10/77 → 80  |  | 701 332   | 702 328   |
| R 12 (R1171, R1330/7/8)            | 10/77 → 80  |  | 701 332   | 702 817   |
| R 12 (R2360)                       | 10/77 → 80  |  | 701 332   | 702 817   |
| R 14                               | 78 → 83   |  | 701 432   | 702 328   |
| R 16                               | 11/76 → 80  |  | -   | 702 328   |
| R 17                               | 10/77 → 80  |  | 701 332   | 702 350   |
| R 18 1.4 GTL, L, TL (R1340)        | 81 → 83   | Ch.→534400   | 701 332   | 702 328   |
| R 18 1.4 GTL, L, TL (R1340)        | 84 → 86   | Ch.534401→   | 701 326   | 702 328   |
| R 18 1.4 GTS, TS (R1341)           | 78 → 83   | Ch.→504400   | 701 332   | 702 328   |
| R 18 1.4 GTS, TS (R1341)           | 84 → 86   | Ch.504401→   | 701 326   | 702 328   |
| R 18 1.4 GTL, L, TL (R1350)        | 79 → 82   |  | 701 332   | 702 350   |
| R 18 1.4 GTL, L, TL (R1350)        | 83 → 84   | Ch.→122600   | 701 326   | 702 350   |
| R 18 1.4 GTL, L, TL (R1350)        | 84 → 86   | Ch.122601→   | 701 326   | 702 380   |
| R 18 1.4 4x2 TS (R1351)            | 79 → 82   |  | 701 332   | 702 350   |
| R 18 1.4 4x2 TS (R1351)            | 83 → 84   | Ch.→118200   | 701 326   | 702 350   |
| R 18 1.4 4x2 TS (R1351)            | 84 → 86   | Ch.118201→   | 701 326   | 702 380   |
| R 18 1.4 4x4 GTL (R1351)           | 83 → 86   |  | 701 326   | 702 462   |
| R 18 1.4 4x2 GTS, GTX (R1353)      | 82 → 82   |  | 701 332   | 702 350   |
| R 18 1.4 4x2 GTS, GTX (R1353)      | 83 → 84   | Ch.→9000   | 701 326   | 702 350   |
| R 18 1.4 4x2 GTS, GTX (R1353)      | 84 → 86   | Ch.9001→   | 701 326   | 702 380   |
| R 18 1.4 (R2350)                   | 79 → 82   |  | 701 332   | 702 350   |
| R 18 1.4 (R2350)                   | 83 → 84   | Ch.→4600   | 701 326   | 702 350   |
| R 18 1.4 (R2350)                   | 84 → 86   | Ch.4601→   | 701 326   | 702 380   |
| R 18 1.6 (R134A)                   | 84 → 85   |  | 701 326   | 702 452   |
| R 18 1.6 Turbo (R1345)             | 81 → 83   | Ch.→49569  | 701 326   | 702 350   |
| R 18 1.6 Turbo (R1345)             | 83 → 85   | Ch.49570→  | 701 326   | 702 452   |
| R 18 1.6 Turbo (R1355)             | 83 → 83   | Ch.→1010   | 701 326   | 702 350   |
| R 18 1.6 Turbo (R1355)             | 83 → 85   | Ch.1011→   | 701 326   | 702 452   |
| R 18 1.7 GTS (R1342)               | 82 → 86   |  | 701 326   | 702 328   |
| R 18 1.7 GTS, GTX (R1352)          | 82 → 86   |  | 701 326   | 702 350   |
| R 18 2.0 GTX, TX (R1343)           | 82 → 85   | Ch.→11001  | 701 326   | 702 350   |
| R 18 2.0 GTX, TX (R1343)           | 85 → 86   | Ch.11002→  | 701 326   | 702 380   |
| R 18 2.0 4x4 TX (R1353)            | 83 → 86   |  | 701 326   | 702 462   |
| R 18 2.1 Diesel (R1344)            | 81 → 86   |  | 701 326   | 702 328   |
| R 18 2.1 Turbo Diesel (R1344)      | 81 → 86   |  | 701 326   | 702 328   |
| R 18 2.1 Diesel (R1346)            | 84 → 86   |  | 701 326   | 702 380   |
| R 18 2.1 4x2 Diesel (R1354)        | 81 → 83   | Ch.→50000  | 701 326   | 702 350   |
| R 18 2.1 4x2 Diesel (R1354)        | 84 → 86   | Ch.50001→  | 701 326   | 702 380   |
| R 18 2.1 4x2 Turbo Diesel (R1354)  | 81 → 83   | Ch.→50000  | 701 326   | 702 350   |
| R 18 2.1 4x2 Turbo Diesel (R1354)  | 84 → 86   | Ch.50001→  | 701 326   | 702 380   |
| R 18 2.1 4x4 Diesel (R1354)        | 83 → 86   |  | 701 326   | 702 462   |
| R 18 2.1 4x4 Turbo Diesel (R1354)  | 83 → 86   |  | 701 326   | 702 462   |
| R 18 2.1 Diesel (R1356)            | 84 → 85   |  | 701 326   | 702 380   |
| R 18 2.1 Diesel (R2354)            | 79 → 84   | Ch.→5000   | 701 326   | 702 350   |
| R 18 2.1 Diesel (R2354)            | 84 → 86   | Ch.5001→   | 701 326   | 702 380   |
| R 19 1.2                           | 88 → 95   | {Front  35x65x35}     | 701 302   | 702 312   |
| R 19 1.2                           | - → 05/92   |  | 04-P161   | -   |
| R 19 1.2                           | 88 → 95   | {Front  37x72x37}     | 701 346   | 702 312   |
| R 19 Chamade1.2                    | - → 05/92   |  | 04-P161   | -   |
| R 19 1.4, 1.7, 1.8, 1.9 TD         | - → 05/92   |  | 04-P163   | -   |
| R 19 Chamade 1.4, 1.7, 1.8, 1.9 TD | - → 05/92   |  | 04-P163   | -   |
| R 19 1.4                           | 88 → 95   | ABS {Front  35x65x35} | 701 302   | 702 312   |









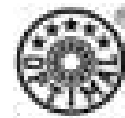













**MODELL/MODEL/MODELE**



**BEMERKUNGEN/REMARKS/  
REMARQUES**























|                                   |                  |           |                       |         |         |
|-----------------------------------|------------------|-----------|-----------------------|---------|---------|
| R 19 1.4, 1.8, 1.9D               |                  | 06/92 → - |                       | 04-P163 | -       |
| R 19 1.4                          |                  | 88 → 95   | ABS {Front  37x72x37} | 701 346 | 702 312 |
| R 19 1.4                          |                  | 88 → 95   | ABS {Front  35x65x35} | 701 302 | 702 352 |
| R 19 1.4                          |                  | 88 → 95   | ABS {Front  37x72x37} | 701 346 | 702 352 |
| R 19 1.7                          |                  | 88 → 95   | ABS                   | 700 310 | 702 312 |
| R 19 1.7                          |                  | 88 → 95   | ABS                   | 700 310 | 702 352 |
| R 19 1.8                          |                  | 88 → 95   | ABS                   | 700 310 | 702 312 |
| R 19 1.8                          |                  | 88 → 95   | ABS                   | 700 310 | 702 352 |
| R 19 1.8 16V                      |                  | 88 → 95   |                       | 700 310 | 702 352 |
| R 19 1.9 Diesel, 1.9 Turbo Diesel |                  | 88 → 95   | ABS                   | 700 310 | 702 312 |
| R 19 1.9 Diesel, 1.9 Turbo Diesel |                  | 88 → 95   | ABS                   | 700 310 | 702 352 |
| R 20                              | (R1270)          | 83 → 83   |                       | 701 326 | 702 350 |
| R 20                              | (R1270)          | 84 → 84   |                       | 701 326 | 702 380 |
| R 20 GTL, L, TL                   | (R1271)          | 77 → 84   |                       | 701 332 | 702 350 |
| R 20 TS, TX                       | (R1272)          | 78 → 84   |                       | 701 404 | 702 350 |
| R 20 TS, TX                       | (R1272)          | 81 → 84   |                       | 701 326 | 702 350 |
| R 20 LS, TS                       | (R1276)          | 79 → 83   |                       | 701 326 | 702 350 |
| R 20 LS, TS                       | (R1276)          | 84 → 84   |                       | 701 326 | 702 380 |
| R 20 Turbo Diesel                 | (R1277)          | 81 → 83   |                       | 701 326 | 702 350 |
| R 20 Turbo Diesel                 | (R1277)          | 84 → 84   |                       | 701 326 | 702 380 |
| R 20 TS, TX                       | (R1279)          | 81 → 84   |                       | 701 404 | 702 350 |
| R 21 1.4                          |                  | 88 → 93   |                       | 701 346 | -       |
| R 21 1.4, 1.7                     |                  | 89 → 94   |                       | 04-P163 | -       |
| R 21 1.6                          |                  | 88 → 91   |                       | 701 346 | 702 316 |
| R 21 Diesel                       |                  | 89 → 94   |                       | 04-P165 | -       |
| R 21 1.6                          | (K48..)          | 88 → 92   |                       | 701 346 | 702 452 |
| R 21 1.7                          | (B48..., L48..)  | 88 → 94   |                       | 701 346 | 702 316 |
| R 21 1.7                          | (K48..., S48..)  | 88 → 94   |                       | 701 346 | 702 452 |
| R 21 1.9 Diesel                   | (B48..)          | 88 → 94   |                       | 700 310 | 702 316 |
| R 21 1.9 Diesel                   | (K48..., S48..)  | 88 → 94   |                       | 700 310 | 702 452 |
| R 21 2.0                          | (B48C/R/Y, B483) | 88 → 94   | ABS                   | 701 326 | 702 452 |
| R 21 2.0                          | (B48C/R/Y, B483) | 88 → 94   | ABS                   | 701 326 | 702 494 |
| R 21 2.0                          | (B48J)           | 89 → 94   |                       | 700 310 | 702 316 |
| R 21 2.0                          | (K48C/R/Y, K483) | 88 → 94   | ABS                   | 701 326 | 702 452 |
| R 21 2.0                          | (K48C/R/Y, K483) | 88 → 94   | ABS                   | 701 326 | 702 494 |
| R 21 2.0                          | (K48J)           | 88 → 94   |                       | 700 310 | 702 452 |
| R 21 2.0                          | (L48C/Q/R/Y)     | 88 → 94   | ABS                   | 701 326 | 702 452 |
| R 21 2.0                          | (L48C/Q/R/Y)     | 88 → 94   | ABS                   | 701 326 | 702 494 |
| R 21 2.0                          | (L483, L489)     | 88 → 94   | ABS                   | 701 326 | 702 452 |
| R 21 2.0                          | (L483, L489)     | 88 → 94   | ABS                   | 701 326 | 702 494 |
| R 21 2.0                          | (L48J)           | 88 → 94   |                       | 700 310 | 702 316 |
| R 21 2.0 4x4                      |                  | 88 → 94   |                       | 701 326 | 702 765 |
| R 21 2.1 Diesel                   |                  | 88 → 94   | ABS                   | 701 326 | 702 452 |
| R 21 2.1 Diesel                   | (B480, B486)     | 88 → 94   | ABS                   | 701 326 | 702 316 |
| R 21 2.1 Diesel                   | (L480, L486)     | 88 → 94   | ABS                   | 701 326 | 702 316 |
| R 21 2.1 Diesel                   | (L48O, L48V)     | 88 → 94   | ABS                   | 701 326 | 702 316 |
| R 21 2.1 Diesel                   |                  | 88 → 94   | ABS                   | 701 326 | 702 494 |
| R 21 2.1 Diesel 4x4               |                  | 88 → 92   |                       | 701 326 | 702 765 |
| R 21 2.1 Turbo Diesel             |                  | 88 → 94   | ABS                   | 701 326 | 702 452 |
| R 21 2.1 Turbo Diesel             | (B480, B486)     | 88 → 94   | ABS                   | 701 326 | 702 316 |
| R 21 2.1 Turbo Diesel             | (L480, L486)     | 88 → 94   | ABS                   | 701 326 | 702 316 |
| R 21 2.1 Turbo Diesel             | (L48O, L48V)     | 88 → 94   | ABS                   | 701 326 | 702 316 |
| R 21 2.1 Turbo Diesel             |                  | 88 → 94   | ABS                   | 701 326 | 702 494 |
| R 21 2.2                          |                  | 88 → 94   | ABS                   | 701 326 | 702 452 |

| MODELL/MODEL/MODELE               |  | BEMERKUNGEN/REMARKS/<br>REMARQUES   |  |  |
|-----------------------------------|---|---|---|---|
| R 21 2.2                          | 88 → 94   | ABS   | 701 326   | 702 494   |
| R 21 2.2 4x4                      | 88 → 94   |   | 701 326   | 702 765   |
| R 25 2.0                          | 89 → 93   | <del>ABS</del>  | 701 326   | 702 452   |
| R 25                              | 84 → 93   | ABS   | 04-P165   | -   |
| R 25 2.0 (L48O, L48V)             | 89 → 93   | <del>ABS</del>  | 701 326   | 702 380   |
| R 25 2.0                          | 89 → 93   | ABS   | 701 326   | 702 514   |
| R 25 2.1 Diesel, 2.1 Turbo Diesel | 84 → 92   | <del>ABS</del>  | 701 326   | 702 380   |
| R 25 2.1 Diesel, 2.1 Turbo Diesel | 84 → 92   | ABS   | 701 326   | 702 514   |
| R 25 2.2                          | 84 → 90   | <del>ABS</del>  | 701 326   | 702 380   |
| R 25 2.2                          | 84 → 05/87  | ABS   | 701 326   | 702 552   |
| R 25 2.2                          | 06/87 → 90  | ABS   | 701 326   | 702 514   |
| R 25 2.4 V6 Turbo, 2.5 V6 Turbo   | 84 → 92   |   | 701 326   | 702 552   |
| R 25 2.7 V6, 2.8 V6               | 84 → 92   | <del>ABS</del>  | 701 326   | 702 550   |
| R 25 2.7 V6, 2.8 V6               | 84 → 92   | ABS   | 701 326   | 702 552   |
| R 30 2.1 Turbo Diesel             | 82 → 83   |   | 701 326   | 702 350   |
| R 30 2.1 Turbo Diesel             | 84 → 84   |   | 701 326   | 702 380   |
| R 30 2.6, 2.6 TS, 2.6 TX          | 78 → 84   |   | 701 404   | 702 350   |
| Safrane 2.0 (B54E, B542)          | 92 → 07/96  |  x4 <del>ABS</del> | 701 307   | 702 452   |
| Safrane 2.0 (B54E, B542)          | 92 → 02/95  |  x4 ABS            | 701 307   | 702 311   |
| Safrane 2.0 (B54E, B542)          | 02/95 → 07/96   |  x5                | 701 307   | 702 313   |
| Safrane 2.0 (B540)                | 92 → 07/96  |  <del>ABS</del>    | 701 307   | 702 452   |
| Safrane 2.0 (B540)                | 92 → 07/96  |  ABS               | 701 307   | 702 311   |
| Safrane 2.0 16V (B54L)            | 07/96 → 00  |   | 701 307   | 702 313   |
| Safrane 2.1 Turbo Diesel (B546)   | 93 → 07/96  |  <del>ABS</del>  | 701 307   | 702 452   |
| Safrane 2.1 Turbo Diesel (B546)   | 93 → 07/96  |  ABS             | 701 307   | 702 311   |
| Safrane 2.2 (B541)                | 92 → 07/96  |  <del>ABS</del>  | 701 307   | 702 452   |
| Safrane 2.2 (B541)                | 92 → 07/96  |  ABS             | 701 307   | 702 311   |
| Safrane 2.2 (B54H, B543)          | 92 → 02/95  |  x4              | 701 307   | 702 311   |
| Safrane 2.2 (B54H, B543)          | 03/95 → 96  |  x5              | 701 307   | 702 313   |
| Safrane 2.2 Turbo Diesel (B54G)   | 96 → 00   |   | 701 307   | 702 313   |
| Safrane 2.5 20V (B54F)            | 96 → 00   |   | 701 307   | 702 313   |
| Safrane 2.5 Turbo Diesel (B548)   | 92 → 02/95  |  x4              | 701 307   | 702 311   |
| Safrane 2.5 Turbo Diesel (B548)   | 03/95 → 00  |  x5              | 701 307   | 702 313   |
| Safrane 2.9 24V (B54N)            | 99 → 00   |   | 701 307   | 702 313   |
| Safrane 3.0 V6 (B54B, B544)       | 92 → 00   |   | 701 307   | 702 313   |
| Safrane 3.0 V6 4x4 (B54B, B544)   | 92 → 07/96  |   | 701 307   | 702 765   |
| Safrane 3.0 Biturbo 4x4 (B545)    | 93 → 07/96  |   | 701 307   | 702 765   |
| Scenic II 1.4i 16V (JM0/1)        | 02 → 06   | ABS - Active Sensor Bearing   | 701 977   | 702 983   |
| Scenic II 1.5 dCi (JM0/1)         | 02 → 06   | ABS - Active Sensor Bearing   | 701 977   | 702 983   |
| Scenic II 1.6i 16V (JM0/1)        | 02 → 06   | ABS - Active Sensor Bearing   | 701 977   | 702 983   |
| Scenic II 1.9 dCi (JM0/1)         | 02 → 06   | ABS - Active Sensor Bearing   | 701 978   | 702 983   |
| Scenic II 2.0i 16V (JM0/1)        | 02 → 06   | ABS - Active Sensor Bearing   | 701 977   | 702 983   |
| Scenic II - Grand Scenic          | 04 → 06   | {Rear: Wheel bearing with brake disc}   | 701 978   | -   |
| Sport Spider                      | 95 → 99   |   | 701 326   | 701 326   |
| Thalia 1.2 16V                    | 02 → 06   |                  | 700 310   | 702 312   |
| Thalia 1.2 16V                    | 02 → 06   |                  | 700 310   | 702 352   |
| Thalia 1.4 8V                     | 00 → 06   |                  | 701 302   | 702 312   |
| Thalia 1.4 8V                     | 00 → 06   |                  | 701 302   | 702 352   |
| Thalia 1.4 16V                    | 00 → 06   |                  | 700 310   | 702 312   |
| Thalia 1.4 16V                    | 00 → 06   |                  | 700 310   | 702 352   |
| Thalia 1.5 dCi                    | 01 → 06   |                  | 700 310   | 702 312   |
| Thalia 1.5 dCi                    | 01 → 06   |                  | 700 310   | 702 352   |
| Thalia 1.6 16V                    | 02 → 06   |                  | 700 310   | 702 312   |
| Thalia 1.6 16V                    | 02 → 06   |                  | 700 310   | 702 352   |









































































| MODELL/MODEL/MODELE                     |  | BEMERKUNGEN/REMARKS/<br>REMARQUES   |  |  |
|---|---|---|---|---|
| Twingo                                  | 93 → 02   |   | 701 302   | 702 312   |
| Twingo                                  | - → -   |   | 04-P161   | -   |
| Vel Satis                               | 02 → 06   |  ABS - Active Sensor Bearing {Rear:  with brake disc} | 701 247   | 702 899   |
| Master I Series P, Q                    | RWD 81 → 07/98  |    | 701 728   | 702 448   |
| Master I Series R, T                    | FWD 81 → 07/98  |    | 701 726   | 702 436   |
| Master II<br>(ED../FD../HD../JD../UD..) | 07/98 → 05  |    | 701 860   | 702 846   |
| Trafic<br>(PA, P5, P6, P8)              | 81 → 89   |    | 701 424   | 702 462   |
| Trafic<br>(PC)                          | 84 → 06/97  |    | 701 424   | 702 448   |
| Trafic<br>(P3)                          | 81 → 84   |  Ch→5239   | 701 424   | 702 462   |
| Trafic<br>(P3)                          | 84 → 93   |  Ch.5240→  | 701 424   | 702 448   |
| Trafic<br>(T)                           | 81 → 83   |    | 701 404   | 702 692   |
| Trafic<br>(T)                           | 84 → 85   |    | 701 404   | 702 456   |
| Trafic<br>(T)                           | 86 → 04/89  |    | 701 404   | 702 692   |
| Trafic 1.7, 2.0, 2.1 Diesel             | (T) 05/89 → 03/01   |    | 701 404   | 702 586   |
| Trafic 2.2, 2.5 Diesel                  | (T) 05/89 → 03/01   |    | 701 404   | 702 436   |
| Trafic 4x4                              | (V) 85 → 02/89  |    | 701 404   | 702 462   |
| Trafic 4x4                              | (V) 03/89 → 03/01   |    | 701 404   | 702 448   |
| Trafic II                               | 03/01 → 05  |  ABS   | 201 085   | 202 101   |
| Trafic II                               | 03/01 → 05  |  ABS - Active Sensor Bearing   | 201 089   | 202 101   |

| MODELL/MODEL/MODELE      |  | BEMERKUNGEN/REMARKS/<br>REMARQUES |  |  |
|--------------------------|---|-----------------------------------|---|---|
| Allegro                  | 73 → 82   |                                   | 881 507   | 880 525   |
| Cabiolet (XW)            | 92 → 99   |                                   | 881 704   | 912 532   |
| Coupé                    | 92 → 99   | ABS                               | 881 704   | 882 487   |
| Coupé                    | 92 → 99   | ABS                               | 881 704   | 882 483   |
| Ital                     | 81 → 84   |                                   | 880 525   | -   |
| Maestro 1.3              | 83 → 86   | Ch.→378220                        | 881 622   | 882 664   |
| Maestro 1.3              | 86 → 10/88  | Ch.378221→544075                  | 881 534   | 882 664   |
| Maestro 1.3              | 11/88 → 94  | Ch.544076→                        | 881 594   | 882 664   |
| Maestro 1.6              | 83 → 86   | Ch.→378220                        | 881 622   | 882 664   |
| Maestro 1.6              | 86 → 10/88  | Ch.378221→543486                  | 881 534   | 882 664   |
| Maestro 1.6              | 11/88 → 94  | Ch.543487→                        | 881 594   | 882 664   |
| Maestro 2.0 Diesel       | 89 → 94   |                                   | 881 594   | 882 664   |
| Maestro Van 1.3          | 84 → 86   | Ch.→378220                        | 881 622   | 882 643   |
| Maestro Van 1.3          | 86 → 10/88  | Ch.378221→544012                  | 881 534   | 882 643   |
| Maestro Van 1.3          | 11/88 → 94  | Ch.544013→                        | 881 594   | 882 643   |
| Maestro Van 2.0 Diesel   | 89 → 94   |                                   | 881 594   | 882 643   |
| Metro 1.0                | 81 → 03/90  |                                   | 881 507   | 882 598   |
| Metro 1.1                | 04/90 → 94  |                                   | 881 594   | 882 463   |
| Metro 1.3                | 81 → 03/90  |                                   | 881 507   | 882 598   |
| Metro 1.4                | 04/90 → 94  |                                   | 881 594   | 882 463   |
| Metro 1.4 Diesel         | 93 → 94   |                                   | 881 594   | 882 463   |
| M.G.F                    | 95 → 03/96  |                                   | 881 594   | 881 594   |
| Mini 1275 GT             | 69 → 80   |                                   | 881 592   | 882 596   |
| Mini Ser.                | 60 → 80   |                                   | 881 507   | 882 598   |
| Mini                     | 10/80 → 84  | Ch.→239250                        | 881 507   | 882 598   |
| Mini                     | 84 → 85   | Ch.239251→282410                  | 881 592   | 882 596   |
| Mini                     | 85 → 95   | Ch.282411→                        | 881 592   | 882 598   |
| Mini Automatic           | 10/80 → 84  | Ch.→234913                        | 881 507   | 882 598   |
| Mini Automatic           | 84 → 85   | Ch.234914→282410                  | 881 592   | 882 596   |
| Mini Automatic           | 85 → 95   | Ch.282411→                        | 881 592   | 882 598   |
| Mini 25 (Anniversary)    | 84 → 85   |                                   | 881 592   | 882 596   |
| Mini Turbo               | 84 → 94   |                                   | 881 592   | 882 598   |
| Mini Van 1/4 ton         | 60 → 84   |                                   | 881 507   | 882 598   |
| Mini Van 1/4 ton         | 85 → 85   |                                   | 881 592   | 882 598   |
| Montego 1.3              | 84 → 86   | Ch.→258963                        | 881 622   | 882 664   |
| Montego 1.3              | 86 → 10/88  | Ch.258964→464730                  | 881 534   | 882 664   |
| Montego 1.6              | 84 → 86   | Ch.→256885                        | 881 622   | 882 664   |
| Montego 1.6              | 86 → 10/88  | Ch.256886→463106                  | 881 534   | 882 664   |
| Montego 1.6              | 11/88 → 94  | Ch.463107→                        | 881 594   | 882 664   |
| Montego 2.0              | 84 → 86   | Ch.→256308                        | 881 622   | 882 664   |
| Montego 2.0              | 86 → 10/88  | Ch.256309→462776                  | 881 534   | 882 664   |
| Montego 2.0              | 11/88 → 94  | Ch.462776→                        | 881 594   | 882 664   |
| Montego 2.0 Automatic    | 86 → 86   | Ch.→269012                        | 881 622   | 882 664   |
| Montego 2.0 Automatic    | 86 → 10/88  | Ch.269013→464730                  | 881 534   | 882 664   |
| Montego 2.0 Automatic    | 11/88 → 94  | Ch.464731→                        | 881 594   | 882 664   |
| Montego 2.0 Turbo Diesel | 89 → 94   |                                   | 881 594   | 882 664   |
| Montego MG Turbo         | 86 → 86   | Ch.→273470                        | 881 622   | 882 664   |
| Montego MG Turbo         | 86 → 10/88  | Ch.273471→462788                  | 881 534   | 882 664   |
| Montego MG Turbo         | 11/88 → 94  | Ch.462789→                        | 881 594   | 882 664   |
| Rover 100                | 91 → 98   |                                   | 881 594   | 882 463   |
| Rover 200 (XH)           | 84 → 85   | Ch.→783329                        | 911 600   | -   |
| Rover 200 (XH)           | 85 → 89   | Ch.783330→                        | 911 600   | 912 530   |
| Rover 200 (XW)           | 90 → 99   | ABS                               | 881 704   | 882 487   |
| Rover 200 1.4 (XW)       | 90 → 02/96  | ABS Ch.→911247                    | 881 704   | 882 626   |











| MODELL/MODEL/MODELE        |       | BEMERKUNGEN/REMARKS/<br>REMARQUES |   |  |         |
|----------------------------|-------|-----------------------------------|---|---|---------|
| Rover 200 1.6              | (XW)  | 90 → 02/96                        | ABS Ch.→911247  | 881 704   | 882 624 |
| Rover 200 1.8 Turbo Diesel | (XW)  | 90 → 02/96                        | ABS Ch.→911247  | 881 704   | 882 626 |
| Rover 200 2.0              | (XW)  | 90 → 02/96                        | ABS Ch.→911247  | 881 704   | 882 626 |
| Rover 200                  | (XW)  | 03/96 → 00                        | ABS Ch.911248→  | 881 704   | 882 483 |
| Rover 200                  | (RF)  | 11/95 → 02                        | ABS            | 881 704   | 882 487 |
| Rover 200                  | (RF)  | 11/95 → 02                        | ABS            | 881 704   | 882 896 |
| Rover 200                  | (RF)  | 11/95 → 02                        | ABS            | 881 704   | 882 483 |
| Rover 25                   | (RF)  | 11/99 → 04                        | ABS            | 881 704   | 882 487 |
| Rover 25                   | (RF)  | 11/99 → 04                        | ABS            | 881 704   | 882 896 |
| Rover 25                   | (RF)  | 11/99 → 04                        | ABS            | 881 704   | 882 483 |
| Rover 400                  | (XW)  | 90 → 00                           | ABS   | 881 704   | 882 487 |
| Rover 400 1.4              | (XW)  | 90 → 02/96                        | ABS Ch.→911247  | 881 704   | 882 626 |
| Rover 400 1.6              | (XW)  | 90 → 02/96                        | ABS Ch.→911247  | 881 704   | 882 624 |
| Rover 400 1.8 Turbo Diesel | (XW)  | 90 → 02/96                        | ABS Ch.→911247  | 881 704   | 882 626 |
| Rover 400 1.9 Diesel       | (XW)  | 90 → 02/96                        | ABS Ch.→911247  | 881 704   | 882 626 |
| Rover 400 2.0              | (XW)  | 90 → 02/96                        | ABS Ch.→911247  | 881 704   | 882 626 |
| Rover 400                  | (XW)  | 03/96 → 00                        | ABS Ch.911248→  | 881 704   | 882 483 |
| Rover 400                  | (RT)  | 04/96 → 00                        | ABS            | 881 725   | 882 487 |
| Rover 400                  | (RT)  | 98 → 00                           | ABS            | 881 725   | 882 896 |
| Rover 400 1.4              | (RT)  | 04/96 → 00                        | ABS  Man.GBX   | 881 725   | 882 483 |
| Rover 400 1.6              | (RT)  | 98 → 00                           | ABS  Aut.GBX   | 881 725   | 882 167 |
| Rover 400 2.0              | (RT)  | 04/96 → 00                        | ABS  Man.GBX   | 881 725   | 882 483 |
| Rover 400 2.0 Diesel       | (RT)  | 04/96 → 00                        | ABS  Man.GBX  | 881 725   | 882 483 |
| Rover 45                   | (RT)  | 01/00 → 04                        | ABS          | 881 725   | 882 487 |
| Rover 45                   | (RT)  | 01/00 → 04                        | ABS          | 881 725   | 882 896 |
| Rover 45                   | (RT)  | 01/00 → 04                        | ABS  Man.GBX | 881 725   | 882 483 |
| Rover 45                   | (RT)  | 01/00 → 04                        | ABS  Aut.GBX | 881 725   | 882 167 |
| Rover 600                  | (RH)  | 93 → 00                           | ABS   | 911 385   | 911 387 |
| Rover 600 1.8              | (RH)  | 93 → 00                           | ABS Ch.→AM 144844   | 911 385   | 882 727 |
| Rover 600 1.8              | (RH)  | 93 → 00                           | ABS Ch.AM 144845→   | 911 385   | 882 729 |
| Rover 600 2.0              | (RH)  | 93 → 00                           | ABS Ch.→AM 144844   | 911 385   | 882 727 |
| Rover 600 2.0              | (RH)  | 93 → 00                           | ABS Ch.AM 144845→   | 911 385   | 882 729 |
| Rover 600 2.0 Turbo        | (RH)  | 93 → 00                           | ABS Ch.→AM 246796   | 911 385   | 882 607 |
| Rover 600 2.0 Turbo        | (RH)  | 93 → 00                           | ABS Ch.BM 246797→   | 911 385   | 882 729 |
| Rover 600 2.0 Diesel       | (RH)  | 93 → 00                           | ABS Ch.→AM 246796   | 911 385   | 882 607 |
| Rover 600 2.0 Diesel       | (RH)  | 93 → 00                           | ABS Ch.BM 246797→   | 911 385   | 882 729 |
| Rover 600 2.3              | (RH)  | 93 → 00                           | ABS Ch.→AM 144844   | 911 385   | 882 727 |
| Rover 600 2.3              | (RH)  | 93 → 00                           | ABS Ch.AM 144845→   | 911 385   | 882 729 |
| Rover 75                   |       | 99 → 04                           | ABS - Active Sensor Bearing Ch.AM 144845→   | 881 237   | 882 235 |
| Rover 800                  | (XS)  | 86 → 91                           |              | 881 609   | 882 611 |
| Rover 800                  | (XS)  | 86 → 91                           |              | 881 609   | 882 613 |
| Rover 800                  | (RS)  | 92 → 99                           |              | 881 609   | 882 611 |
| Rover 800                  | (RS)  | 92 → 99                           |              | 881 609   | 882 613 |
| Rover 2300                 | (SD1) | 76 → 86                           |   | 881 529   | 882 531 |
| Rover 2600                 | (SD1) | 76 → 86                           |   | 881 529   | 882 531 |
| Rover 3500                 | (SD1) | 76 → 86                           |   | 881 529   | 882 531 |
| Vanden Plas 1500           |       | 75 → 81                           |   | 881 507   | 880 525 |





| MODELL/MODEL/MODELE |  | BEMERKUNGEN/REMARKS/<br>REMARQUES          |  |  |
|---------------------|---|--|---|---|
| 90                  | 85 → 85   | Ch.→F6009038                               | 891 706   | 892 806   |
| 90                  | 85 → 87   | Ch.F6009039→                               | 891 524   | 892 670   |
| 99                  | 79 → 82   | Ch.→6009295                                | -   | 892 830   |
| 99                  | 82 → 82   | Ch.6009296→6010841                         | -   | 892 806   |
| 99                  | 82 → 84   | Ch.6010842→                                | 891 706   | 892 806   |
| 600 1.5             | 80 → 05/84  |  | 800 304   | 802 318   |
| 600 1.5             | 06/84 → 87  |  | 800 304   | 802 324   |
| 900                 | 79 → 80   |  | -   | 892 830   |
| 900                 | 81 → 82   | Ch.→C1021263/C2007508/C3006827/C6001805    | 891 706   | 892 830   |
| 900                 | 82 → 85   | Ch.C1021264→F1029809 Ch.C2007509→F2015343  | 891 706   | 892 806   |
| 900                 | 82 → 85   | Ch.C3006828→F3012344 Ch.C6001806→F7010668  | 891 706   | 892 806   |
| 900                 | 85 → 85   | Ch.F1029810-/F2015344-/F3012345-/F7010669→ | 891 706   | 892 670   |
| 900                 | 86 → 87   |  | 891 524   | 892 670   |
| 900                 | 88 → 93   | <del>ABS</del>                             | 891 524   | 892 476   |
| 900                 | 88 → 89   | ABS  | 891 524   | 892 668   |
| 900                 | 90 → 93   | ABS  | 891 524   | 892 498   |
| 900                 | 94 → 98   |  | 891 630   | 202 218   |
| 9000                | 85 → 89   | <del>ABS</del>                             | 891 546   | 892 476   |
| 9000                | 86 → 89   | ABS  | 891 546   | 892 668   |
| 9000                | 90 → 92   | <del>ABS</del>                             | 891 496   | 892 476   |
| 9000                | 90 → 92   | ABS  | 891 496   | 892 498   |
| 9000                | 93 → 98   |  | 891 496   | 892 498   |
| 9-3                 | 98 → 99   | Ch.→X2028828                               | 891 630   | 202 218   |
| 9-3                 | 99 → 09/02  | Ch.X2028829→                               | 891 887   | 202 218   |
| 9-3                 | 09/02 → 06  |  | 201 517   | 202 519   |
| 9-5                 | 98 → 99   | Ch.→X3025768                               | 891 630   | 202 218   |
| 9-5                 | 99 → 04   | Ch.X3025769→                               | 891 887   | 202 218   |



| MODELL/MODEL/MODELE |  | BEMERKUNGEN/REMARKS/<br>REMARQUES  |  |  |
|---------------------|---|--|---|---|
| 124, 124 D          | 68 → 80   |  | -   | 802 480   |
| 127                 | 76 → 85   |  | 800 408   | 802 318   |
| 128                 | 76 → 80   |  | 800 408   | 802 318   |
| 131                 | 75 → 84   |  | 801 698   | 802 480   |
| 132                 | 72 → 82   |  | 801 402   | 802 480   |
| 132                 | 72 → 82   |  | 801 171   | 802 480   |
| 133                 | 74 → 81   |  | 801 538   | -   |
| 133                 | 74 → 81   |  | 801 173   | -   |
| Alhambra            | 95 → 05   |  | 131 129   | 132 131   |
| Alhambra            | 96 → 00   |  | 04-P201   | -   |
| Alhambra 4 Motion   | 00 → 05   |  | 131 129   | 131 129   |
| Alhambra            | 96 → 00   |  | -   | 04-P201   |
| Altea               | 03/04 → 06  |  280 mm   | 101 699   | 102 213   |
| Arosa               | 97 → 00   |  Ch.→6HX027500   | -   | 04-P010   |
| Arosa               | 97 → 00   |  Ch.→6HX027500         | -   | 04-P006   |
| Altea               | 03/04 → 06  |  280 mm   | 101 017   | 102 213   |
| Arosa               | 97 → 00   |  Ch.→6HX027500         | -   | 04-P008   |
| Arosa               | - → 03  | with ABS ring  | 04-P155   | -   |
| Arosa               | 97 → 99   | Ch.→6HX027500  | 101 016   | 100 002   |
| Arosa               | 99 → 04   | Ch.6HX027501→  | 101 016   | 102 075   |
| Cordoba             | 93 → 99   | Ch.→6KX399999  | 100 022   | 100 002   |
| Cordoba             | 93 → 01   |   | 04-P101   | -   |
| Cordoba             | 93 → 01   |    | 04-P109   | -   |
| Cordoba             | 99 → 08/02  | Ch.6KX400001→6K2220000   | 100 022   | 102 075   |
| Cordoba             | 09/02 → 05  | Ch.6L3060000→   | 101 027   | 102 015   |
| Cordoba             | 09/02 → 05  | Ch.6L3060000→  - Active Sensor Bearing  | 101 027   | 102 077   |
| Cordoba             | 93 → 99   |  Ch.→6KX399999   | -   | 04-P010   |
| Cordoba             | 93 → 99   |  Ch.→6KX399999   | -   | 04-P006   |
| Cordoba             | 93 → 99   |  Ch.→6KX399999   | -   | 04-P008   |
| Cordoba             | 93 → 99   |  Ch.→6KX399999   | -   | 04-P002   |
| Cordoba             | 93 → 99   |  Ch.→6KX399999   | -   | 04-P004   |
| Ibiza               | - → 92  |  | 04-P101   | -   |
| Ibiza               | 93 → 01   |   | 04-P101   | -   |
| Ibiza               | 93 → 01   |   | 04-P109   | -   |
| Ibiza               | 93 → 99   |  Ch.→6KX399999   | -   | 04-P010   |
| Ibiza               | 93 → 99   |  Ch.→6KX399999   | -   | 04-P006   |
| Ibiza               | 93 → 99   |  Ch.→6KX399999   | -   | 04-P008   |
| Ibiza               | 93 → 99   |  Ch.→6KX399999   | -   | 04-P002   |
| Ibiza               | 93 → 99   |  Ch.→6KX399999   | -   | 04-P004   |
| Furgoneta 903 Terra | 87 → 90   |  | 801 342   | -   |
| Inca                | 97 → 01   |   | 04-P101   | -   |
| Inca                | 97 → 01   |   | 04-P109   | -   |
| Toledo              | - → 91  | ABS  | 04-P101   | -   |
| Toledo              | 92 → 99   |   x4   | 04-P109   | -   |
| Toledo 2.0 16V      | 92 → 99   |   x5   | 04-P111   | -   |
| Toledo              | 92 → 99   |   | 04-P101   | -   |
| Toledo              | 93 → 98   |    | -   | 04-P010   |
| Toledo              | 93 → 98   |                   | -   | 04-P006   |
| Toledo              | 93 → 98   |                   | -   | 04-P008   |
| Toledo              | 93 → 98   |                   | -   | 04-P002   |
| Toledo              | 93 → 98   |                   | -   | 04-P004   |
| Ibiza I             | 85 → 93   |  | 801 354   | 802 318   |
| Ibiza II            | 93 → 08/99  | Ch.→6KX399999  | 100 022   | 100 002   |
| Ibiza III           | 08/99 → 02/02   | Ch.6KX400001→6K2199999   | 100 022   | 102 075   |

| MODELL/MODEL/MODELE       |  | BEMERKUNGEN/REMARKS/<br>REMARQUES   |  |  |
|---------------------------|---|---|---|---|
| Ibiza IV 1.2              | 12/01 → 05/05   | Ch.6L2000001→  ABS                         | 101 025   | 102 015   |
| Ibiza IV 1.2              | 12/01 → 05/05   | Ch.6L2000001→  ABS - Active Sensor Bearing | 101 025   | 102 077   |
| Ibiza IV 1.2              | 12/01 → 05/05   | Ch.6L2000001→  ABS                         | 101 027   | 102 015   |
| Ibiza IV 1.2              | 12/01 → 05/05   | Ch.6L2000001→  ABS - Active Sensor Bearing | 101 027   | 102 077   |
| Ibiza IV 1.4 16V          | 12/01 → 05/05   | Ch.6L2000001→ <del>ABS</del>  | 101 027   | 102 015   |
| Ibiza IV 1.4 16V          | 12/01 → 05/05   | Ch.6L2000001→ ABS - Active Sensor Bearing   | 101 027   | 102 077   |
| Ibiza IV 1.4 TDI          | 02 → 05/05  | Ch.6L2000001→ <del>ABS</del>  | 101 027   | 102 015   |
| Ibiza IV 1.4 TDI          | 02 → 05/05  | Ch.6L2000001→ ABS - Active Sensor Bearing   | 101 027   | 102 077   |
| Ibiza IV 1.6              | 02 → 05/05  | Ch.6L2000001→ <del>ABS</del>  | 101 027   | 102 015   |
| Ibiza IV 1.6              | 02 → 05/05  | Ch.6L2000001→ ABS - Active Sensor Bearing   | 101 027   | 102 077   |
| Ibiza IV 1.8 T            | 03 → 05/05  | Ch.6L2000001→ <del>ABS</del>  | 101 027   | 102 015   |
| Ibiza IV 1.8 T            | 03 → 05/05  | Ch.6L2000001→ ABS - Active Sensor Bearing   | 101 027   | 102 077   |
| Ibiza IV 1.9 SDI, 1.9 TDI | 12/01 → 05/05   | Ch.6L2000001→ <del>ABS</del>  | 101 027   | 102 015   |
| Ibiza IV 1.9 SDI, 1.9 TDI | 12/01 → 05/05   | Ch.6L2000001→ ABS - Active Sensor Bearing   | 101 027   | 102 077   |
| Inca                      | 95 → 97   | Ch.→9KV015942   | 100 022   | 102 008   |
| Inca                      | 97 → 05/99  | Ch.9KV015943→9KX023408  | 100 022   | 102 055   |
| Inca                      | 05/99 → 04  | Ch.9KX023409→ <del>ABS</del>  | 100 022   | 102 079   |
| Inca                      | 05/99 → 04  | Ch.9KX023409→ ABS   | 100 022   | 102 158   |
| Leon                      | 00 → 04   |   | 101 113   | 102 115   |
| Leon 4x4                  | 00 → 04   |   | 101 113   | 101 113   |
| Malaga                    | 85 → 93   |   | 801 354   | 802 318   |
| Marbella                  | 86 → 98   |   | 801 342   | 802 394   |
| Panda                     | 80 → 85   |   | 801 342   | 802 394   |
| Panda Terra               | 83 → 90   |   | 801 342   | -   |
| Panda Trans               | 83 → 90   |   | 801 342   | -   |
| Ritmo                     | 78 → 82   |   | 801 354   | 802 318   |
| Ronda                     | 83 → 86   |   | 801 354   | 802 318   |
| Toledo I 1.6i             | 91 → 03/99  |   | 100 022   | 100 002   |
| Toledo I 1.8i             | 91 → 96   |   | 100 022   | 100 002   |
| Toledo I 1.8 16V          | 91 → 03/99  |   | 100 022   | 100 002   |
| Toledo I 1.9 D, 1.9 TD    | 91 → 03/99  |   | 100 022   | 100 002   |
| Toledo I 1.9 SDI, 1.9 TDI | 95 → 03/99  |   | 100 022   | 100 002   |
| Toledo I 2.0i             | 91 → 96   |   | 100 022   | 100 002   |
| Toledo I 2.0 16V          | 95 → 03/99  |   | 101 024   | 100 002   |
| Toledo II                 | 04/99 → 04  |   | 101 113   | 102 115   |
| Toledo III                | 10/04 → 06  |  280 mm                                  | 101 699   | 102 019   |
| Toledo III                | 10/04 → 06  |  <del>280 mm</del>                       | 101 017   | 102 019   |



| MODELL/MODEL/MODELE         |  | BEMERKUNGEN/REMARKS/<br>REMARQUES   |  |  |
|-----------------------------|---|---|---|---|
| 105 S, 105 L                | 77 → 89   |   | 801 618   | 802 720   |
| 120, 120 L, 120 LS, 120 GLS | 77 → 89   |   | 801 618   | 802 720   |
| Fabia 1.0, 1.2, 1.4 8V      | 12/99 → 06  |  ABS                         | 101 025   | 102 015   |
| Fabia 1.0, 1.2, 1.4 8V      | 12/99 → 06  |  ABS - Active Sensor Bearing | 101 025   | 102 077   |
| Fabia 1.0, 1.2, 1.4 8V      | 12/99 → 06  |  ABS                         | 101 027   | 102 015   |
| Fabia 1.0, 1.2, 1.4 8V      | 12/99 → 06  |  ABS - Active Sensor Bearing | 101 027   | 102 077   |
| Fabia 1.4 16V               | 12/99 → 06  |  ABS                         | 101 027   | 102 015   |
| Fabia 1.4 16V               | 12/99 → 06  | ABS - Active Sensor Bearing   | 101 027   | 102 077   |
| Fabia 1.9 Sdi, 1.9 Tdi      | 00 → 06   |  ABS                         | 101 027   | 102 015   |
| Fabia 1.9 Sdi, 1.9 Tdi      | 00 → 06   | ABS - Active Sensor Bearing   | 101 027   | 102 077   |
| Fabia 2.0                   | 00 → 06   |  ABS                         | 101 027   | 102 015   |
| Fabia 2.0                   | 00 → 06   | ABS - Active Sensor Bearing   | 101 027   | 102 077   |
| Favorit 115, 135, 136       | 88 → 92   |   | 801 694   | 802 732   |
| Favorit 115, 135, 136       | - → 12/93   |   | 04-P217   | -   |
| Favorit 115, 135, 136       | 01/93 → 04/93   |   | 801 694   | 100 002   |
| Favorit 115, 135, 136       | 05/93 → 94  |   | 801 543   | 100 002   |
| Felicia                     | 94 → 01   |   | 801 543   | 100 002   |
| Forman                      | 91 → 92   |   | 801 694   | 802 732   |
| Forman                      | - → 12/93   |   | 04-P217   | -   |
| Forman                      | 93 → 01   |   | 801 694   | 100 002   |
| Octavia                     | 96 → 06/04  |   | 101 113   | 102 115   |
| Octavia                     | 06/04 → 05  | Ch.1Z4000001→   | 101 017   | 102 115   |
| Octavia 4x4                 | 99 → 04   |   | 101 113   | 101 113   |
| Pick-up                     | 95 → 02   |   | 801 543   | 100 002   |
| Superb 1.8 Turbo 20V        | 02/02 → 06  |   | 100 091   | 102 011   |
| Superb 1.9 TDI              | 74 kW 02/02 → 06  |   | 100 091   | 102 011   |
| Superb 1.9 TDI              | 96 kW 02/02 → 06  |   | 100 098   | 102 011   |
| Superb 2.0                  | 02/02 → 06  |   | 100 091   | 102 011   |
| Superb 2.5 V6 TDI           | 02/02 → 06  |   | 100 098   | 102 011   |
| Superb 2.8 V6               | 02/02 → 06  |   | 100 098   | 102 011   |

| MODELL/MODEL/MODELE |  | BEMERKUNGEN/REMARKS/<br>REMARQUES |  |  |
|---------------------|---|-----------------------------------|---|---|
| Smart 0.6           | 98 → 04   |                                   | 401 300   | 402 301   |
| Smart 0.7           | 98 → 04   |                                   | 401 300   | 402 301   |
| Smart 0.8 CDI       | 98 → 04   |                                   | 401 300   | 402 301   |
| For Four            | 04/04 → 06  |                                   | -   | 402 467   |

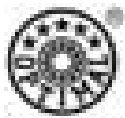

| MODELL/MODEL/MODELE         |  | BEMERKUNGEN/REMARKS/<br>REMARQUES |  |  |
|-----------------------------|---|-----------------------------------|---|---|
| Forester 4WD 2.0i 16V       | 97 → 05   |                                   | 971 707   | 972 709   |
| Forester 4WD 2.0i 16V Turbo | 98 → 05   |                                   | 971 707   | 972 709   |
| Forester 4WD 2.5i 16V       | 03 → 05   |                                   | 971 707   | 972 709   |
| Impreza 1.6i 16V            | 98 → 04   |                                   | 971 707   | 972 709   |
| Impreza 1.8i 16V            | 98 → 04   |                                   | 971 707   | 972 709   |
| Impreza 2.0i 16V            | 98 → 04   |                                   | 971 707   | 972 709   |
| Impreza 4WD 1.6i 16V        | 92 → 04   |                                   | 971 707   | 972 709   |
| Impreza 4WD 1.8i 16V        | 92 → 04   |                                   | 971 707   | 972 709   |
| Impreza 4WD 2.0i 16V        | 92 → 04   |                                   | 971 707   | 972 709   |
| Impreza 4WD 2.0i 16V Turbo  | 92 → 04   |                                   | 971 707   | 972 709   |
| Justy                       | 84 → 07/86  |                                   | -   | 972 637   |
| Justy                       | 08/86 → 09/88   |                                   | 971 635   | 972 637   |
| Justy                       | 10/88 → 09/95   |                                   | 971 641   | 972 637   |
| Justy 4WD                   | 84 → 07/86  |                                   | -   | 972 639   |
| Justy 4WD                   | 08/86 → 09/88   |                                   | 971 635   | 972 639   |
| Justy 4WD                   | 10/89 → 09/95   |                                   | 971 641   | 972 639   |
| Justy 4WD                   | 10/95 → 04  |                                   | 971 711   | 972 715   |
| Legacy 1.8i 16V             | 90 → 04   |                                   | 971 707   | 972 709   |
| Legacy 2.0i 16V             | 91 → 04   |                                   | 971 707   | 972 709   |
| Legacy 2.2i 16V             | 90 → 04   |                                   | 971 707   | 972 709   |
| Legacy 4WD 1.8i 16V         | 90 → 04   |                                   | 971 707   | 972 709   |
| Legacy 4WD 2.0i 16V         | 91 → 04   |                                   | 971 707   | 972 709   |
| Legacy 4WD 2.0i 16V Turbo   | 91 → 04   |                                   | 971 707   | 972 709   |
| Legacy 4WD 2.2i 16V         | 90 → 04   |                                   | 971 707   | 972 709   |
| Legacy 4WD 2.5i 16V         | 96 → 04   |                                   | 971 707   | 972 709   |
| Legacy IV                   | 09/03 → 06  |                                   | 971 707   | 972 709   |
| Leone                       | 80 → 07/84  |                                   | 971 615   | 972 633   |
| Leone                       | 08/84 → 12/84   |                                   | 971 615   | 972 633   |
| Leone                       | 01/85 → 91  | 2-Doors Type MV                   | 971 615   | 972 633   |
| Leone                       | 01/85 → 91  | 3- & 4-Doors Type SW, XT          | 971 631   | 972 633   |
| Leone 4WD                   | 80 → 07/84  |                                   | 971 615   | 972 465   |
| Leone 4WD                   | 08/84 → 12/84   |                                   | 971 615   | 972 465   |
| Leone 4WD                   | 01/85 → 91  | 2-Doors Type MV                   | 971 615   | 972 465   |
| Leone 4WD                   | 01/85 → 91  | 3- & 4-Doors Type SW, XT          | 971 631   | 972 465   |
| Libero 1.0                  | 08/86 → 04/93   |                                   | 971 635   | -   |
| Libero 1.2i                 | 05/96 → 00  |                                   | 971 285   | -   |
| Libero 4WD 1.0, 1.2         | 08/86 → 04/93   |                                   | 971 635   | -   |
| Libero 4WD 1.2i             | 05/93 → 00  |                                   | 971 285   | -   |
| Loyale                      | 89 → 94   |                                   | 971 631   | 972 633   |
| Loyale 4WD                  | 89 → 94   |                                   | 971 631   | 972 465   |
| Outback                     | 10/00 → 06  |                                   | 971 707   | -   |
| Vivio 660 4WD               | 93 → 06/97  |                                   | 971 285   | 971 707   |
| XT 1.8i Turbo               | 84 → 91   |                                   | 971 631   | 972 633   |
| XT 1.8i Turbo 4WD           | 84 → 91   |                                   | 971 631   | 972 465   |



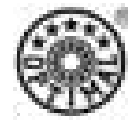

| MODELL/MODEL/MODELE             |                    |  | BEMERKUNGEN/REMARKS/<br>REMARQUES |  |  |
|---------------------------------|--------------------|---|-----------------------------------|---|---|
| Alto 0.8                        | (SS80F, SS80G)     | 81 → 07/94  |                                   | 971 455   | 972 453   |
| Alto 0.8 SB308                  | (CA91, CB91)       | 81 → 07/94  |                                   | 971 455   | 972 453   |
| Alto 1.0 SH410                  | (FA11)             | 08/94 → 04  |                                   | 971 575   | 972 453   |
| Baleno                          | (EG)               | 95 → 04   | ABS                               | 971 723   | 972 299   |
| Baleno                          | (EG)               | 95 → 04   | ABS                               | 971 723   | 972 973   |
| Baleno 4WD                      | (EG)               | 95 → 04   |                                   | 971 723   | 972 715   |
| Cappucino                       |                    | 92 → 95   |                                   | -   | 972 715   |
| Carry 0.8                       | (ST90)             | 81 → 88   |                                   | 972 453   | -   |
| Carry 1.0                       | (DA21)             | 86 → 98   |                                   | 971 567   | 972 573   |
| Carry 1.3i 16V                  | (DA32)             | 99 → 02   |                                   | 971 567   | 972 573   |
| Carry Super 0.8                 | (DA21)             | 85 → 88   |                                   | 971 567   | 972 573   |
| Carry Super 1.0                 | (DA21)             | 85 → 02   |                                   | 971 567   | 972 573   |
| Esteem                          |                    | 06/89 → 92  |                                   | 971 723   | 972 717   |
| Grand Vitara 1.6i 16V           | (TA03, TB03)       | 98 → 09/05  |                                   | 971 612   | -   |
| Grand Vitara 2.0i 16V           | (TA52, TD32)       | 97 → 09/05  |                                   | 971 612   | -   |
| Grand Vitara 2.0 TD Intercooler | (TD32, TD82)       | 97 → 09/05  |                                   | 971 612   | -   |
| Grand Vitara 2.0 HDI            | (TD32, TD82)       | 01 → 09/05  |                                   | 971 612   | -   |
| Grand Vitara 2.5 V6 24V         | (TD62)             | 97 → 09/05  |                                   | 971 612   | -   |
| Grand Vitara 2.7 V6 24V         | (HT92)             | 01 → 09/05  |                                   | 971 612   | -   |
| Ignis II                        |                    | 09/03 → 06  |                                   | 801 829   | -   |
| Jimny 1.3i 16V                  | (JA33V)            | 98 → 04   |                                   | 971 612   | 972 571   |
| Jimny 4WD 1.3i 16V              | (JB33V)            | 98 → 05/99  |                                   | 971 612   | 972 571   |
| Jimny 4WD 1.3i 16V              | (JB33V)            | 06/99 → 04  |                                   | 971 612   | -   |
| Liana 2WD                       | (ER)               | 01 → 06   | ABS                               | 971 821   | 972 299   |
| Liana 2WD                       | (ER)               | 01 → 06   | ABS                               | 971 821   | 972 973   |
| Liana 4WD                       | (ER)               | 01 → 06   |                                   | 971 821   | 972 715   |
| Maruti 0.8                      | (CA91, CB91)       | 88 → 90   |                                   | 971 455   | 972 453   |
| SJ 410                          | (SJ40)             | 81 → 88   |                                   | 971 451   | 972 573   |
| SJ 413 Samurai                  |                    | 84 → 88   |                                   | 971 451   | 972 573   |
| SJ 413 Samurai                  |                    | 88 → 00   |                                   | 971 451   | 972 571   |
| SX4                             |                    | 06/06 → 12/06   |                                   | 801 829   | -   |
| Swift SA 310                    | (AA41, AA43)       | 83 → 88   | Ch.→S00111752 Ch.→F00104359       | 971 455   | 972 453   |
| Swift SA 310                    | (AA41, AA43)       | 08/86 → 88  | Ch.S00111753→ Ch.F00104360→       | 971 575   | 972 453   |
| Swift SA 413                    | (AA51, AA53)       | 84 → 88   |                                   | 971 575   | 972 453   |
| Swift SF 310                    | (AA44)             | 89 → 94   |                                   | 971 711   | 972 453   |
| Swift SF 310 H                  | (MAA44)            | 95 → 01   | ABS                               | 971 575   | 972 719   |
| Swift SF 310 H                  | (MAA44)            | 95 → 01   | ABS                               | 971 575   | -   |
| Swift SF 413                    | (AA35, AB35, AH35) | 89 → 03/96  | 2-Doors                           | 971 711   | 972 719   |
| Swift SF 413                    | (AA35, AB35, AH35) | 89 → 03/96  | 4-Doors                           | 971 711   | 972 717   |
| Swift SF 413                    | (AA35, AB35, AH35) | 89 → 03/96  | 3- & 5-Doors                      | 971 711   | 972 721   |
| Swift SF 413 H                  | (MAB35)            | 94 → 01   | 2-Doors                           | 971 575   | 972 719   |
| Swift SF 413 H                  | (MAB35)            | 95 → 01   | 4-Doors                           | 971 575   | 972 717   |
| Swift SF 413 Cabrio             | (AK35)             | 91 → 03/96  |                                   | 971 711   | 972 719   |
| Swift SF 413 GTI                | (AA34)             | 89 → 01   |                                   | 971 723   | 972 717   |
| Swift SF 413 4WD                | (AA35, AF35)       | 89 → 03/96  |                                   | 971 711   | 972 715   |
| Swift SF 416                    | (AH14)             | 89 → 03/96  |                                   | 971 723   | 972 717   |
| Swift SF 416 4WD                | (AJ14)             | 90 → 03/96  |                                   | 971 723   | 972 715   |
| Swift SG                        |                    | 05 → 06   |                                   | 801 829   | -   |
| Vitara                          |                    | 88 → 00   |                                   | 971 612   | 972 688   |
| Wagon R+ 1.0i                   | (EM)               | 97 → 05/00  |                                   | 201 087   | 972 453   |
| Wagon R+ 1.2i                   | (EM)               | 98 → 05/00  |                                   | 201 087   | 972 453   |
| Wagon R+ 1.2i 4WD               | (EM)               | 98 → 05/00  |                                   | 201 087   | 972 275   |
| Wagon R+ 1.3i                   | (MM)               | 05/00 → 04  |                                   | 201 087   | 202 224   |
| Wagon R+ 1.3i 4WD               | (MM)               | 10/01 → 04  |                                   | 201 087   | 972 275   |









| MODELL/MODEL/MODELE |                 | BEMERKUNGEN/REMARKS/<br>REMARQUES |  |         |         |
|---------------------|-----------------|-----------------------------------|--|---------|---------|
| Wagon R+ 1.3 DDiS   | (MM) 09/03 → 04 |                                   |  | 201 087 | 972 275 |
| X-90 1.6i 16V       | 09/95 → 06/02   |                                   |  | 971 612 | 972 688 |
| X-90 1.6i 16V 4x4   | 09/95 → 06/02   |                                   |  | 971 612 | 972 688 |



| MODELL/MODEL/MODELE |  | BEMERKUNGEN/REMARKS/<br>REMARQUES |  |  |
|---------------------|---|-----------------------------------|---|---|
| 1100                | 78 → 81   | Made in France Ch.S.8202418→      | 601 446   | 600 410   |
| 1510                | 80 → 84   | Made in France                    | 601 446   | 600 410   |
| Alpine              | 80 → 84   | Made in GB                        | 601 446   | 600 410   |
| Horizon             | 78 → 86   | Made in France                    | 601 446   | 600 410   |
| Matra-Rancho        | 78 → 84   | Made in France                    | 601 446   | 600 410   |
| Minx                | 85 → 86   | Made in GB                        | 601 446   | 600 410   |
| Rapier              | 85 → 86   | Made in GB                        | -   | 602 881   |
| Samba               | 82 → 86   | Made in France                    | 601 396   | 602 414   |
| Solara              | 81 → 86   | Made in France                    | 601 446   | 600 410   |
| Tagora              | 81 → 83   | Made in France                    | 601 384   | 602 390   |



| MODELL/MODEL/MODELE |         | BEMERKUNGEN/REMARKS/<br>REMARQUES |                  |         |         |
|---------------------|---------|-----------------------------------|------------------|---------|---------|
| J 5 1000/1300 kg    | 82 → 85 |                                   | Ch.→244300       | 681 504 | 682 420 |
| J 5 1000/1300 kg    | 82 → 85 |                                   | Ch.→244300       | 681 504 | 682 422 |
| J 5 1000/1300 kg    | 86 → 89 |                                   | Ch.244301→604496 | 681 504 | 682 508 |
| J 5 1000/1300 kg    | 86 → 89 |                                   | Ch.244301→604496 | 681 504 | 682 510 |
| J 5 1000/1300 kg    | 89 → 90 |                                   | Ch.604497→       | 681 506 | 682 508 |
| J 5 1000/1300 kg    | 89 → 90 |                                   | Ch.604497→       | 681 506 | 682 510 |
| J 5 1400 kg         | 89 → 90 |                                   | Ch.→604496       | 681 504 | 682 508 |
| J 5 1400 kg         | 89 → 90 |                                   | Ch.→604496       | 681 504 | 682 510 |
| J 5 1400 kg         | 89 → 90 |                                   | Ch.604497→       | 681 506 | 682 508 |
| J 5 1400 kg         | 89 → 90 |                                   | Ch.604497→       | 681 506 | 682 510 |
| J 5 1800 kg         | 82 → 89 |                                   | Ch.→604496       | 681 504 | 682 492 |
| J 5 1800 kg         | 82 → 89 |                                   | Ch.→604496       | 681 504 | 682 490 |
| J 5 1800 kg         | 89 → 90 |                                   | Ch.604497→       | 681 506 | 682 492 |
| J 5 1800 kg         | 89 → 90 |                                   | Ch.604497→       | 681 506 | 682 490 |
| J 5 4x4             | 86 → 89 |                                   | Ch.→604496       | 681 504 | 602 430 |
| J 5 4x4             | 89 → 90 |                                   | Ch.604497→       | 681 506 | 602 430 |



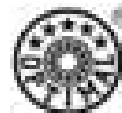







| MODELL/MODEL/MODELE          |              |  | BEMERKUNGEN/REMARKS/<br>REMARQUES   |  |  |
|------------------------------|--------------|---|---|---|---|
| Avensis                      | (T22)        | 10/97 → 04  |   | 981 947   | 982 948   |
| Avensis                      | (T25)        | 04/03 → 05  |   | 981 947   | 982 782   |
| Avensis Station Wagon        | (T22)        | 10/97 → 04  |   | 981 947   | 982 948   |
| Avensis Station Wagon        | (T25)        | 04/03 → 05  |   | 981 947   | 982 782   |
| Avensis Verso                |              | 05/01 → 04  |   | 981 475   | -   |
| Camry 1.8                    | (SV10)       | 10/82 → 87  |   | 981 572   | 982 766   |
| Aygo                         |              | 07/05 → 06  |   | 601 834   | 602 835   |
| Camry 1.8i                   | (SV20)       | 10/86 → 91  |   | 981 572   | 982 766   |
| Camry 1.8i 16V               | (SV30, SV40) | 07/90 → 00  |   | 981 475   | -   |
| Camry 1.8 Turbo Diesel       | (CV10)       | 08/83 → 87  |   | 981 572   | 982 766   |
| Camry 2.0i                   | (SV11)       | 06/84 → 88  |   | 981 616   | 982 766   |
| Camry 2.0i 16V               | (SV21)       | 08/86 → 91  |   | 981 572   | 982 766   |
| Camry 2.0i 16V               | (SV32, SV33) | 07/90 → 94  |   | 981 475   | -   |
| Camry 2.0i 16V               | (SV35)       | 07/90 → 04/94   |   | 981 475   | 980 614   |
| Camry 2.0i 16V               | (SV41, SV42) | 06/94 → 00  |   | 981 475   | -   |
| Camry 2.0i 16V               | (SV43)       | 06/94 → 00  |   | 981 475   | 980 614   |
| Camry 2.0 Turbo Diesel       | (CV11, CV20) | 08/85 → 91  |   | 981 572   | 982 766   |
| Camry 2.0 Turbo Diesel       | (CV30)       | 07/90 → 04/94   |   | 981 475   | 982 766   |
| Camry 2.2i 16V               | (SXV10)      | 07/91 → 96  |   | 981 475   | 982 431   |
| Camry 2.2i 16V               | (SXV20)      | 08/96 → 08/00   |   | 981 475   | 982 431   |
| Camry 2.2i 16V               | (SXV20)      | 09/00 → 02  |   | 981 475   | -   |
| Camry 2.2i 16V               | (SXV25W)     | 06/97 → 08/00   |   | 981 475   | 982 431   |
| Camry 2.4 VVT-i 16V          | (ACV30)      | 08/01 → 04  |   | 981 475   | -   |
| Camry 2.5i V6 24V            | (VZV21)      | 02/88 → 91  |   | 981 616   | 982 766   |
| Camry 2.5i V6 24V            | (MCV21)      | 08/99 → 00  |   | 981 475   | 982 431   |
| Camry 3.0i V6 24V            | (VCV10)      | 07/91 → 96  |   | 981 475   | 982 431   |
| Camry 3.0i V6 24V            | (MCV20)      | 08/96 → 07/99   |   | 981 475   | 982 431   |
| Camry 3.0i V6 24V            | (MCV20)      | 08/99 → 01  |   | 981 475   | -   |
| Camry 3.0i V6 24V            | (MCV30)      | 08/01 → 04  |   | 981 475   | -   |
| Camry 4WD 2.0i 16V           | (SV25)       | 08/88 → 91  |   | 981 616   | 982 766   |
| Camry 4WD 2.2i 16V           | (SXV25)      | 08/99 → 00  |   | 981 475   | 982 431   |
| Camry Wagon 2.0i 16V         | (SV21)       | 08/86 → 91  |   | 981 616   | 982 431   |
| Camry Wagon 2.0 Turbo Diesel | (CV20)       | 08/85 → 91  |   | 981 572   | 982 431   |
| Camry Wagon 2.2i 16V         | (SXV10)      | 03/92 → 96  |   | 981 475   | 982 431   |
| Camry Wagon 2.5i V6 24V      | (VZV21)      | 90 → 94   |   | 981 572   | 982 766   |
| Camry Wagon 3.0i V6 24V      | (VCV10)      | 06/92 → 07/01   |   | 981 475   | 982 431   |
| Carina 1.5                   | (TA60)       | 08/81 → 07/85   |  | 981 790   | 982 764   |
| Carina 1.6                   | (TA60)       | 08/81 → 07/85   |  | 981 790   | 982 764   |
| Carina 1.6 DOHC              | (AA63)       | 08/83 → 07/85   |   | 981 814   | 982 373   |
| Carina 1.8                   | (RA60)       | 08/81 → 07/85   |  | 981 814   | 982 764   |
| Carina 1.8                   | (RA60, RA63) | 08/81 → 07/85   |   | 981 814   | 982 373   |
| Carina 2.0                   | (RA61)       | 08/81 → 07/85   |   | 981 814   | 982 373   |
| Carina II 1.6                | (AT151)      | 10/83 → 88  |   | 981 572   | 982 766   |
| Carina II 1.6 16V            | (AT171)      | 12/87 → 90  |   | 981 572   | 982 766   |
| Carina II 1.6i 16V           | (AT171)      | 12/87 → 92  | ABS   | 981 572   | 982 766   |
| Carina II 1.6i 16V           | (AT171)      | 12/87 → 92  | ABS   | 981 572   | -   |
| Carina II 1.8i               | (ST150)      | 09/85 → 92  |   | 981 572   | 982 766   |
| Carina II 2.0i 16V           | (ST171)      | 12/87 → 92  |   | 981 572   | 982 766   |
| Carina II 2.0 Diesel         | (CT150)      | 10/83 → 88  |   | 981 572   | 982 766   |
| Carina II 2.0 Diesel         | (CT170)      | 12/87 → 92  |   | 981 572   | 982 766   |
| Carina E 1.6i 16V            | (AT190)      | 02/92 → 10/97   | ABS   | 981 616   | 982 379   |
| Carina E 1.6i 16V            | (AT190)      | 02/92 → 10/97   | ABS   | 981 407   | 982 225   |
| Carina E 1.8i 16V            | (AT191)      | 11/92 → 10/97   | ABS   | 981 616   | 982 379   |
| Carina E 1.8i 16V            | (AT191)      | 11/92 → 10/97   | ABS   | 981 407   | 982 225   |



## BEMERKUNGEN/REMARKS/ REMARQUES



| MODELL/MODEL/MODELE       |                  |               |                                      |  |         |         |
|---------------------------|------------------|---------------|--------------------------------------|--|---------|---------|
| Carina E 2.0i 16V         | (ST191)          | 06/92 → 10/97 | ABS                                  |  | 981 616 | 982 379 |
| Carina E 2.0i 16V         | (ST191)          | 06/92 → 10/97 | ABS                                  |  | 981 407 | 982 225 |
| Carina E 2.0i 16V GT      | (ST191)          | 06/92 → 96    |                                      |  | 981 407 | 982 225 |
| Carina E 2.0 Diesel       | (CT190)          | 02/92 → 10/97 | ABS                                  |  | 981 616 | 982 379 |
| Carina E 2.0 Diesel       | (CT190)          | 02/92 → 98    | ABS                                  |  | 981 407 | 982 225 |
| Carina E 2.0 Turbo Diesel | (CT190)          | 03/96 → 98    | ABS                                  |  | 981 616 | 982 379 |
| Carina E 2.0 Turbo Diesel | (CT190)          | 03/96 → 10/97 | ABS                                  |  | 981 407 | 982 225 |
| Celica 1.6                | (TA60)           | 08/81 → 07/85 | 13"                                  |  | 981 790 | 982 764 |
| Celica 1.6                | (AA63)           | 08/83 → 07/85 | 14"                                  |  | 981 814 | 982 373 |
| Celica 1.6                | (AT160)          | 08/83 → 89    |                                      |  | 981 814 | 982 373 |
| Celica 1.6i 16V           | (AT160)          | 08/85 → 89    |                                      |  | 981 572 | 982 766 |
| Celica 1.6i 16V           | (AT180)          | 10/89 → 11/93 | ABS                                  |  | 981 616 | 982 766 |
| Celica 1.6i 16V           | (AT180)          | 10/89 → 11/93 | ABS                                  |  | 981 407 | 982 766 |
| Celica 1.8                | (RA60)           | 08/81 → 07/85 |                                      |  | 981 447 | 982 764 |
| Celica 1.8                | (RA63)           | 08/81 → 05/83 |                                      |  | 981 447 | -       |
| Celica 1.8                | (RA63)           | 06/83 → 89    |                                      |  | 981 447 | 982 373 |
| Celica 1.8i 16V           | (AT200)          | 11/93 → 11/99 | <del>Reinforced suspension</del> ABS |  | 981 572 | 982 379 |
| Celica 1.8i 16V           | (AT200)          | 11/93 → 11/99 | <del>Reinforced suspension</del> ABS |  | 981 407 | -       |
| Celica 1.8i 16V           | (ZZT230, ZZT231) | 11/99 → 04    |                                      |  | 981 199 | 982 782 |
| Celica 2.0                | (RA61)           | 08/81 → 05/83 |                                      |  | 981 447 | -       |
| Celica 2.0                | (RA61)           | 06/83 → 85    |                                      |  | 981 447 | 982 373 |
| Celica 2.0                | (ST160)          | 08/85 → 08/87 |                                      |  | 981 572 | 982 766 |
| Celica 2.0i 16V           | (ST162)          | 08/87 → 02/89 |                                      |  | 981 572 | 982 766 |
| Celica 2.0i 16V           | (ST182)          | 10/89 → 11/93 | ABS                                  |  | 981 616 | 982 766 |
| Celica 2.0i 16V           | (ST182)          | 10/89 → 11/93 | ABS                                  |  | 981 407 | 982 766 |
| Celica 2.0i 16V           | (ST202)          | 11/93 → 11/99 | <del>Reinforced suspension</del> ABS |  | 981 572 | 982 379 |
| Celica 2.0i 16V           | (ST202)          | 11/93 → 11/99 | <del>Reinforced suspension</del> ABS |  | 981 407 | -       |
| Celica 2.0i 16V           | (ST202)          | 11/93 → 11/99 | Reinforced suspension ABS            |  | 981 745 | 982 379 |
| Celica 2.0i 16V           | (ST202)          | 11/93 → 11/99 | Reinforced suspension ABS            |  | 981 743 | -       |
| Celica 2.8 Supra          | (MA61)           | 08/81 → 05/83 |                                      |  | 981 447 | -       |
| Celica 2.8 Supra          | (MA61)           | 06/83 → 85    |                                      |  | 981 447 | 982 373 |
| Celica 4WD 2.0i 16V Turbo | (ST165)          | 08/87 → 02/88 |                                      |  | 981 572 | 980 614 |
| Celica 4WD 2.0i 16V Turbo | (ST185)          | 10/89 → 04/91 | ABS                                  |  | 981 616 | 980 614 |
| Celica 4WD 2.0i 16V Turbo | (ST185)          | 10/89 → 04/91 | ABS                                  |  | 981 407 | 980 614 |
| Celica 4WD 2.0i 16V Turbo | (ST185)          | 04/91 → 11/93 | ABS                                  |  | 981 616 | 982 737 |
| Celica 4WD 2.0i 16V Turbo | (ST185)          | 04/91 → 11/93 | ABS                                  |  | 981 407 | 982 737 |
| Celica 4WD 2.0i 16V Turbo | (ST205)          | 02/94 → 11/99 | ABS                                  |  | 981 743 | 982 737 |
| Corolla                   | (AE71)           | 08/79 → 86    |                                      |  | 981 790 | -       |
| Corolla 1.3               | (KE70)           | 80 → 05/83    |                                      |  | 981 790 | -       |
| Corolla 1.3               | (AE80)           | 05/83 → 07/87 | {Rear  }                             |  | 981 572 | 982 778 |
| Corolla 1.3               | (AE80)           | 05/83 → 07/87 | {Rear  }                             |  | 981 572 | 982 780 |
| Corolla 1.3               | (EE90)           | 08/87 → 06/91 | {Rear  }                             |  | 981 690 | 982 778 |
| Corolla 1.3               | (EE90)           | 08/87 → 06/91 | {Rear  }                             |  | 981 690 | 982 780 |
| Corolla 1.4i 16V          | (EE101)          | 05/92 → 04/97 | ABS                                  |  | 981 868 | 982 201 |
| Corolla 1.4i 16V          | (EE101)          | 05/92 → 04/97 | ABS                                  |  | 981 856 | 982 857 |
| Corolla 1.4i 16V          | (EE110/111)      | 05/92 → 08/98 | ABS                                  |  | 981 868 | 982 201 |
| Corolla 1.4i 16V          | (EE110/111)      | 05/92 → 08/98 | ABS                                  |  | 981 856 | 982 857 |
| Corolla 1.4i 16V          | (EE111U)         | 09/98 → 09/01 |                                      |  | 981 203 | -       |
| Corolla 1.4i 16V          | (ZZE111)         | 10/99 → 09/01 |                                      |  | 981 203 | -       |
| Corolla 1.4i 16V          | (ZZE120)         | 10/01 → 03    |                                      |  | 981 199 | -       |
| Corolla 1.5i 16V          | (AE110)          | 05/95 → 98    | ABS                                  |  | 981 868 | 982 857 |
| Corolla 1.5i 16V          | (AE110)          | 05/95 → 98    | ABS                                  |  | 981 856 | 982 857 |
| Corolla 1.6               | (TE71)           | 80 → 05/83    |                                      |  | 981 790 | -       |
| Corolla 1.6 GT            | (TE71)           | 80 → 05/83    |                                      |  | 981 790 | 982 764 |



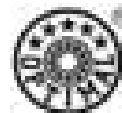





































| MODELL/MODEL/MODELE         |               |  | BEMERKUNGEN/REMARKS/<br>REMARQUES   |  |  |
|-----------------------------|---------------|---|---|---|---|
| Corolla 1.6                 | (AE82)        | 05/83 → 07/87   | {Rear  } | 981 572   | 982 778   |
| Corolla 1.6                 | (AE82)        | 05/83 → 07/87   | {Rear  } | 981 572   | 982 780   |
| Corolla 1.6 16V             | (AE92)        | 08/87 → 06/91   | {Rear  } | 981 690   | 982 778   |
| Corolla 1.6 16V             | (AE92)        | 08/87 → 06/91   | {Rear  } | 981 690   | 982 780   |
| Corolla 1.6i 16V            | (AE100-111)   | 05/92 → 08/98   | <del>ABS</del>  | 981 868   | 982 201   |
| Corolla 1.6i 16V            | (AE100-111)   | 05/92 → 08/98   | ABS   | 981 856   | 982 857   |
| Corolla 1.6i 16V            | (AE111U)      | 09/98 → 09/01   |   | 981 203   | -   |
| Corolla 1.6i 16V            | (ZZE112)      | 10/99 → 09/01   |   | 981 203   | -   |
| Corolla 1.6i 16V            | (ZZE121)      | 10/01 → 03  |   | 981 199   | -   |
| Corolla 1.8                 | (TE72)        | 80 → 05/83  |   | 981 790   | 982 764   |
| Corolla 1.8i 16V            | (ZZE123)      | 10/01 → 03  |   | 981 199   | -   |
| Corolla 1.8 Diesel          | (CE80)        | 05/83 → 07/87   | {Rear  } | 981 572   | 982 778   |
| Corolla 1.8 Diesel          | (CE80)        | 05/83 → 07/87   | {Rear  } | 981 572   | 982 780   |
| Corolla 1.8 Diesel          | (CE90)        | 05/87 → 90  | {Rear  } | 981 690   | 982 778   |
| Corolla 1.8 Diesel          | (CE90)        | 05/87 → 90  | {Rear  } | 981 690   | 981 747   |
| Corolla 2.0 Diesel          | (CE100/110)   | 05/92 → 07/00   | <del>ABS</del>  | 981 868   | 982 201   |
| Corolla 2.0 Diesel          | (CE100/110)   | 05/92 → 07/00   | ABS   | 981 856   | 982 857   |
| Corolla 2.0i Turbo Diesel   | (CDE110)      | 08/00 → 09/01   |   | 981 203   | -   |
| Corolla 2.0 TDi 16V         | (CDE120)      | 10/01 → 03  |   | 981 199   | -   |
| Corolla Verso 1.6 VVT-i 16V | (_E12J_)      | 02 → 04   |   | 981 199   | -   |
| Corolla Verso 1.8 VVT-i 16V | (_E12J_)      | 02 → 04   |   | 981 199   | -   |
| Corolla Verso 2.0 D-4D      | (_E12J_)      | 02 → 05/04  |   | 981 199   | -   |
| Corolla Verso               |               | 06/04 → 06  |   | 981 149   | -   |
| Corona FF                   | (AT151)       | 10/83 → 11/87   |   | 981 572   | 982 766   |
| Corona FF                   | (CT150,ST150) | 10/83 → 11/87   |   | 981 572   | 982 766   |
| Corona                      | (CT141)       | 12/86 → 02/90   |   | 981 447   | 982 764   |
| Cressida 1.8                | (YX76V)       | 11/84 → 02/93   |   | 981 814   | 982 764   |
| Cressida 1.8                | (SX80)        | 08/88 → 10/93   |   | -   | 982 764   |
| Cressida 1.8                | (SX90)        | 10/92 → 04/94   |   | -   | 982 559   |
| Cressida 2.0                | (GX70G)       | 11/84 → 02/94   |   | -   | 982 764   |
| Cressida 2.0                | (YX78V)       | 02/93 → 02/94   |   | 981 814   | 982 764   |
| Cressida 2.0                | (YX80Y)       | 08/88 → 10/93   |   | -   | 982 764   |
| Cressida 2.0                | (GX81)        | 08/88 → 10/93   |   | -   | 982 559   |
| Cressida 2.0                | (GX90)        | 10/92 → 04/94   |   | -   | 982 559   |
| Cressida 2.0                | (GX100)       | 09/96 → 00  |   | -   | 982 559   |
| Cressida 2.4 Diesel         | (LX76V)       | 11/84 → 02/94   |   | 981 814   | 982 764   |
| Cressida 2.4 Diesel         | (LX80)        | 08/88 → 02/93   |   | -   | 982 764   |
| Cressida 2.4 Diesel         | (LX90)        | 10/92 → 04/94   |   | -   | 982 559   |
| Cressida 2.4 Diesel         | (LX100)       | 09/96 → 00  |   | -   | 982 559   |
| Cressida 2.5                | (JZX81)       | 08/90 → 02/93   |   | -   | 982 559   |
| Cressida 2.5                | (JZX90,JZX93) | 10/93 → 04/94   |   | -   | 982 559   |
| Cressida 2.5                | (JZX100/105)  | 09/96 → 00  |   | -   | 982 559   |
| Cressida 3.0                | (MX83)        | 08/88 → 02/93   |   | -   | 982 559   |
| Cressida 3.0                | (MX91)        | 10/92 → 04/94   |   | -   | 982 559   |
| Cressida 3.0                | (MX101)       | 09/96 → 00  |   | -   | 982 559   |
| Crown                       | (MS122)       | 08/83 → 08/87   |   | 981 798   | 982 800   |
| Crown                       | (LS120,YS120) | 08/83 → 08/87   |   | 981 798   | 982 800   |
| Crown                       | (YS132)       | 09/87 → 08/89   |   | 981 798   | 982 800   |
| Crown                       | (LS130,MS130) | 09/87 → 08/89   |   | 981 798   | 982 800   |
| Crown                       | (MS123/125)   | 08/83 → 08/87   |   | 981 798   | 982 373   |
| Crown 2.0                   | (GS130)       | 90 → 98   |   | 981 798   | -   |
| Crown 2.0                   | (GS131/141)   | 09/87 → 11/93   |   | 981 798   | -   |
| Crown 2.0                   | (YS130)       | 12/91 → 96  |   | 981 798   | 982 800   |
| Crown 2.0 Diesel            | (LS130G)      | 09/87 → 10/91   |   | 981 798   | -   |





## BEMERKUNGEN/REMARKS/ REMARQUES













































| MODELL/MODEL/MODELE      |               |       |         |     |  |                 |
|--------------------------|---------------|-------|---------|-----|--|-----------------|
| Crown 2.4 Diesel         | (LS130/131)   | 09/89 | → 11/93 |     |  | 981 798 -       |
| Crown 2.4 Diesel         | (LS136V/141)  | 09/89 | → 11/93 |     |  | 981 798 -       |
| Crown 2.5                | (JZS130G/131) | 08/90 | → 11/93 |     |  | 981 798 -       |
| Crown 2.5                | (JZS141)      | 10/91 | → 11/93 |     |  | 981 798 -       |
| Crown 3.0                | (JZS133/135)  | 10/91 | → 11/93 |     |  | 981 798 -       |
| Crown 3.0                | (JZS143/145)  | 10/91 | → 11/93 |     |  | 981 798 -       |
| MR2 1.6i 16V             | (AW11)        | 11/84 | → 07/86 |     |  | 981 747 -       |
| MR2 1.6i 16V             | (AW11)        | 08/86 | → 89    |     |  | 981 747 981 616 |
| MR2 2.0i 16V             | (SW20)        | 06/90 | → 00    |     |  | 981 283 982 289 |
| Paseo Cabriolet 1.5i 16V | (EL54)        | 95    | → 00    | ABS |  | 981 851 982 561 |
| Paseo Cabriolet 1.5i 16V | (EL54)        | 95    | → 00    | ABS |  | 981 763 982 561 |
| Paseo Coupé 1.5i 16V     | (EL44)        | 94    | → 00    | ABS |  | 981 851 982 561 |
| Paseo Coupé 1.5i 16V     | (EL44)        | 94    | → 00    | ABS |  | 981 763 982 561 |
| Picnic 2.0i 16V          | (SXM10)       | 09/95 | → 02    | ABS |  | 981 475 -       |
| Picnic 2.0i 16V          | (SXM10)       | 09/96 | → 02    | ABS |  | 981 475 -       |
| Picnic 2.2 Diesel        | (CXM10)       | 09/96 | → 02    | ABS |  | 981 475 -       |
| Picnic 2.2 Diesel        | (CXM10)       | 09/96 | → 02    | ABS |  | 981 475 -       |
| Previa 2.4i 16V          | (TCR1/2)      | 90    | → 08/00 |     |  | 981 944 982 800 |
| Previa 2.4i 16V 4WD      | (TCR1/2)      | 90    | → 08/00 |     |  | 981 944 982 945 |
| Prius 1.5i 16V           | (NHW11)       | 05/00 | → 01/04 |     |  | 981 199 982 782 |
| RAV 4 I 2.0i 16V         | (SXA10/11)    | 04/94 | → 00    | ABS |  | 981 572 982 762 |
| RAV 4 I 2.0i 16V         | (SXA10/11)    | 04/94 | → 00    | ABS |  | 981 407 982 762 |
| RAV 4 II 1.8 VVTi        | (ZCA25/26)    | 05/00 | → 05    |     |  | 981 475 -       |
| RAV 4 II 2.0 VVTi 4WD    | (ACA20/21)    | 05/00 | → 05    |     |  | 981 475 -       |
| RAV 4 II 2.0 D-4D 4WD    | (CLA20/21)    | 05/01 | → 05    |     |  | 981 475 -       |
| Starlet 1.0              | (EP70)        | 84    | → 89    |     |  | 981 744 982 816 |
| Starlet 1.0              | (EP80)        | 12/89 | → 03/95 |     |  | 981 744 982 561 |
| Starlet 1.3              | (EP71)        | 10/84 | → 89    |     |  | 981 744 982 816 |
| Starlet 1.3i             | (EP81, EP82)  | 12/89 | → 03/95 |     |  | 981 744 982 561 |
| Starlet 1.3i             | (EP85)        | 12/89 | → 03/95 |     |  | 981 744 982 561 |
| Starlet 1.3i 16V         | (EP91, EP95)  | 11/95 | → 99    |     |  | 981 744 982 561 |
| Starlet 1.5 Diesel       | (NP70)        | 12/86 | → 89    |     |  | 981 744 982 816 |
| Starlet 1.5 Diesel       | (NP80)        | 12/89 | → 03/95 |     |  | 981 744 982 561 |
| Starlet 1.5 Diesel       | (NP90)        | 11/95 | → 99    |     |  | 981 744 982 561 |
| Supra 2.0i 16V           | (GA70)        | 86    | → 05/93 |     |  | 981 805 982 559 |
| Supra 2.5i 16V           | (JZA70)       | 08/90 | → 05/93 |     |  | 981 805 982 559 |
| Supra 3.0i V6 24V        | (MA70)        | 86    | → 92    |     |  | 981 805 982 559 |
| Supra 3.0i V6 24V Turbo  | (MA70)        | 87    | → 93    |     |  | 981 805 982 559 |
| Supra 3.0i V6 24V Turbo  | (JZA80)       | 05/93 | → 07/96 |     |  | 981 805 982 559 |
| Tercel 1.3               | (AL20, AL21)  | 82    | → 84    |     |  | 981 742 982 816 |
| Tercel 1.3               | (EL41)        | 09/90 | → 02/94 |     |  | 981 851 982 561 |
| Tercel 1.3               | (EL51)        | 04/94 | → 98    |     |  | 981 851 -       |
| Tercel 1.5 4WD           | (AL25)        | 82    | → 88    |     |  | 981 742 -       |
| Tercel 1.5               | (EL42)        | 09/90 | → 10/92 |     |  | 981 851 982 561 |
| Tercel 1.5               | (EL43)        | 09/90 | → 08/94 |     |  | 981 851 982 561 |
| Tercel 1.5               | (EL45)        | 09/90 | → 08/94 |     |  | 981 851 -       |
| Tercel 1.5               | (EL53, EL55)  | 09/94 | → 98    |     |  | 981 851 -       |
| Tercel 1.5 Diesel        | (NL40)        | 09/90 | → 08/94 |     |  | 981 851 982 561 |
| Tercel 1.5 Diesel        | (NL50)        | 09/94 | → 98    |     |  | 981 851 -       |
| Yaris 1.0i 16V           | (CP10)        | 99    | → 05    | ABS |  | 981 938 982 939 |
| Yaris 1.0i 16V           | (CP10)        | 99    | → 05    | ABS |  | 981 938 982 195 |
| Yaris 1.0i VVT-i         |               | 01/06 | → 06    | ABS |  | 981 824 982 939 |
| Yaris 1.0i VVT-i         |               | 01/06 | → 06    | ABS |  | 981 824 982 195 |
| Yaris 1.3i 16V           | (CP10/11)     | 99    | → 12/05 | ABS |  | 981 938 982 939 |

| MODELL/MODEL/MODELE   |               |  | BEMERKUNGEN/REMARKS/<br>REMARQUES  |  |  |
|-----------------------|---------------|---|--|---|---|
| Yaris 1.3i 16V        | (CP10/11)     | 99 → 12/05  | ABS  | 981 938   | 982 195   |
| Yaris 1.3i VVT-i      |               | 01/06 → 06  | <del>ABS</del>   | 981 824   | 982 939   |
| Yaris 1.3i VVT-i      |               | 01/06 → 06  | ABS  | 981 824   | 982 195   |
| Yaris 1.4 D-4D        | (CP10/11)     | 01 → 05   | <del>ABS</del>   | 981 938   | 982 939   |
| Yaris 1.4 D-4D        | (CP10/11)     | 01 → 05   | ABS  | 981 938   | 982 195   |
| Yaris 1.5 VVT-i       | (CP10/11)     | 01 → 05   | <del>ABS</del>   | 981 938   | 982 939   |
| Yaris 1.5 VVT-i       | (CP10/11)     | 01 → 05   | ABS  | 981 938   | 982 195   |
| Yaris 1.5 TS          | (CP10/11)     | 03 → 05   | <del>ABS</del>   | 981 938   | 982 939   |
| Yaris 1.5 TS          | (CP10/11)     | 03 → 05   | ABS  | 981 938   | 982 195   |
| Yaris D-4D            |               | 01/06 → 06  | <del>ABS</del>   | 981 824   | 982 939   |
| Yaris D-4D            |               | 01/06 → 06  | ABS  | 981 824   | 982 195   |
| Yaris Verso 1.3i 16V  | (NCP20)       | 99 → 05   | <del>ABS</del>   | 981 938   | 982 939   |
| Yaris Verso 1.3i 16V  | (NCP20)       | 99 → 05   | ABS  | 981 938   | 982 195   |
| Yaris Verso 1.4 D-4D  | (NLP20/22)    | 01 → 05   | <del>ABS</del>   | 981 938   | 982 939   |
| Yaris Verso 1.4 D-4D  | (NLP20/22)    | 01 → 05   | ABS  | 981 938   | 982 195   |
| Yaris Verso 1.5 VVT-i | (NCP21)       | 00 → 05   | <del>ABS</del>   | 981 938   | 982 939   |
| Yaris Verso 1.5 VVT-i | (NCP21)       | 00 → 05   | ABS  | 981 938   | 982 195   |
| Hi-Ace 1.6            | (RH11/20/30)  | 77 → 88   |   | 191 272   | 192 274   |
| Hi-Ace 1.8            | (YH50/60)     | 82 → 88   |   | 191 272   | 192 274   |
| Hi-Ace 2.0i           | (YH51/61)     | 84 → 89   |   | 191 272   | 192 274   |
| Hi-Ace 2.0i           | (RZH102/112)  | 08/89 → 08/95   |   | 191 272   | 982 774   |
| Hi-Ace 2.0i           | (YY101)       | 05/95 → 99  |    | 191 272   | 982 884   |
| Hi-Ace 2.2 D          | (LH50/60/70)  | 82 → 88   |   | 191 272   | 982 884   |
| Hi-Ace 2.4i           | (RZH103/113)  | 08/89 → 08/95   |   | 191 272   | 982 774   |
| Hi-Ace 2.4i 4WD       | (RZH109/119)  | 08/89 → 08/95   |   | 191 258   | 982 884   |
| Hi-Ace 2.4i           | (RZH133)      | 05/95 → 97  |   | 191 272   | 982 884   |
| Hi-Ace 2.4i           | (RCH12)       | 08/95 → 04  |   | 191 272   | 982 287   |
| Hi-Ace 2.4 D          | (LH51/61)     | 84 → 88   |   | 191 272   | 982 774   |
| Hi-Ace 2.4 D          | (LH102/112)   | 08/89 → 08/95   |   | 191 272   | 982 774   |
| Hi-Ace 2.4 D 4WD      | (LH108/118)   | 08/89 → 08/95   |   | 191 258   | 982 884   |
| Hi-Ace 2.4 D          | (LXH12/22)    | 08/95 → 04  |   | 191 272   | 982 287   |
| Hi-Ace 2.4 TD         | (LH51/61)     | 87 → 95   |   | 191 272   | 982 774   |
| Hi-Ace 2.4 TD         | (LXH12/22)    | 08/95 → 04  |   | 191 272   | 982 287   |
| Hi-Ace 2.7i           | (RCH13)       | 04/98 → 04  |   | 191 272   | 982 287   |
| Hi-Ace 2.8 D          | (LY101,LY111) | 05/95 → 99  |   | 191 272   | 982 884   |
| Hi-Ace 2.8 D 4WD      | (LY151,LY161) | 05/95 → 99  |   | 191 258   | 982 884   |
| Hi-Ace 3.0i           | (KZH100)      | 05/95 → 99  |   | 191 272   | 982 774   |
| Hi-Ace 3.0i           | (KZH110/120)  | 05/95 → 99  |   | 191 272   | 982 774   |
| Hi-Ace 3.0i           | (KZH132)      | 05/95 → 99  |   | 191 272   | 982 884   |
| Hi-Ace 3.0i 4WD       | (KZH138)      | 05/95 → 99  |   | 191 258   | 982 884   |
| Hi-Lux 2WD            |               | 78 → 07/88  |   | 191 272   | 192 274   |
| Hi-Lux 2WD 1.8        | (YN85, YN90)  | 08/88 → 05/94   |   | 191 272   | 982 774   |
| Hi-Lux 2WD 2.4        | (RN58)        | 07/94 → 98  |   | 191 272   | 982 774   |
| Hi-Lux 2WD 2.4 D      | (LN85, LN90)  | 08/88 → 08/97   |   | 191 272   | 982 774   |
| Hi-Lux 2WD 2.8 D      | (LN57)        | 08/95 → 98  |   | 191 272   | 982 774   |
| Hi-Lux 4WD            |               | 84 → 07/88  |  {Front  } | 190 256   | 192 274   |
| Hi-Lux 4WD            |               | 86 → 07/88  |  {Front  } | 191 258   | 192 274   |
| Hi-Lux 4WD 2.2        | (YN106)       | 08/88 → 05/94   |   | 191 258   | 982 884   |
| Hi-Lux 4WD 2.2        | (YN110)       | 08/88 → 05/94   |   | 191 258   | 982 884   |
| Hi-Lux 4WD 2.4        | (RN61)        | 08/88 → 95  |   | 191 258   | 982 884   |
| Hi-Lux 4WD 2.4        | (RN67)        | 08/94 → 98  |   | 191 258   | 982 884   |
| Hi-Lux 4WD 2.4        | (RN106)       | 08/89 → 98  |   | 191 258   | 982 884   |
| Hi-Lux 4WD 2.4        | (RN110)       | 08/89 → 98  |   | 191 258   | 982 884   |
| Hi-Lux 4WD 2.4i 16V   | (RZN168)      | 08/97 → 02  |   | 191 258   | 982 884   |



| MODELL/MODEL/MODELE          |                 | BEMERKUNGEN/REMARKS/<br>REMARQUES |                              |   |                 |
|------------------------------|-----------------|-----------------------------------|------------------------------|---|-----------------|
| Hi-Lux 4WD 2.4i 16V          | (RZN173)        | 08/97 → 02                        |                              |   | 191 258 982 884 |
| Hi-Lux 4WD 2.4 D             | (LN105)         | 08/88 → 98                        |                              |   | 191 258 982 884 |
| Hi-Lux 4WD 2.4 D             | (LN108)         | 08/91 → 98                        |                              |   | 191 258 982 884 |
| Hi-Lux 4WD 2.4 D             | (LN110)         | 08/93 → 98                        |                              |   | 191 258 982 884 |
| Hi-Lux 4WD 2.4 TD            | (LN165)         | 08/97 → 03                        |                              |   | 191 258 982 884 |
| Hi-Lux 4WD 2.4 TD            | (LN170)         | 08/97 → 03                        |                              |   | 191 258 982 884 |
| Hi-Lux 4WD 2.8 D             | (LN67)          | 08/95 → 98                        |                              |   | 191 258 982 884 |
| Hi-Lux 4-Runner 2.4 TD       | (LN130)         | 01/90 → 98                        |                              |   | 191 258 982 884 |
| Hi-Lux 4-Runner 2.7i 16V     | (RZN85W)        | 11/95 → 03                        |                              |   | 981 952 982 884 |
| Hi-Lux 4-Runner 2.7i 16V     | (RZN180)        | 11/95 → 03                        |                              |   | 981 952 982 884 |
| Hi-Lux 4-Runner 3.0i 12V     | (VZN130)        | 08/89 → 99                        |                              |   | 191 258 982 884 |
| Hi-Lux 4-Runner 3.0 TD       | (KZN130)        | 08/93 → 99                        |                              |   | 191 258 982 884 |
| Hi-Lux 4-Runner 3.0 D        | (KZN85G)        | 11/95 → 03                        |                              |   | 981 952 982 884 |
| Hi-Lux 4-Runner 3.0 D        | (KZN85W)        | 11/95 → 03                        |                              |   | 981 952 982 884 |
| Hi-Lux 4-Runner 3.4i V6 24V  | (VZN85)         | 11/95 → 03                        |                              |   | 981 952 982 884 |
| Hi-Lux 4-Runner 3.4i V6 24V  | (VZN180)        | 11/95 → 03                        |                              |   | 981 952 982 884 |
| Kijang                       | (LF30, RF30)    | 01/81 → 09/85                     |                              |   | 191 272 982 884 |
| Landcruiser 2.4              | (RJ70)          | 90 → 04/95                        |                              |   | 981 533 192 274 |
| Landcruiser 2.4 Diesel       | (LJ70)          | 90 → 04/95                        |                              |   | 981 499 982 813 |
| Landcruiser 2.4 Turbo Diesel | (LJ70/73)       | 90 → 04/95                        |                              |   | 981 499 982 813 |
| Landcruiser 3.0 Turbo Diesel | (KZJ70)         | 90 → 04/95                        |                              |   | 981 533 192 274 |
| Landcruiser 3.0 Turbo Diesel | (KZJ70)         | 90 → 04/95                        |                              |   | 981 499 982 813 |
| Landcruiser 3.0 Turbo Diesel | (KZJ90/95)      | 04/96 → 03                        |                              |   | 981 952 982 813 |
| Landcruiser 3.4i 24V         | (VZJ90/95)      | 04/96 → 03                        |                              |   | 981 952 982 813 |
| Landcruiser 3.4 Diesel       | (BJ4../6../7..) | 80 → 89                           | Full-floating axle           |   | 190 256 190 256 |
| Landcruiser 3.4 Diesel       | (BJ4../6../7..) | 80 → 89                           | Semi-floating axle           |   | 190 256 982 581 |
| Landcruiser 3.4 Diesel       | (BJ73)          | 90 → 04/95                        | {Front  } Full-floating axle |   | 981 533 982 811 |
| Landcruiser 3.4 Diesel       | (BJ73)          | 90 → 04/95                        | {Front  } Semi-floating axle |   | 981 533 982 581 |
| Landcruiser 3.4 Diesel       | (BJ73)          | 90 → 04/95                        | {Front  } Full-floating axle |   | 981 499 982 811 |
| Landcruiser 3.4 Diesel       | (BJ73)          | 90 → 04/95                        | {Front  } Semi-floating axle |   | 981 499 982 581 |
| Landcruiser 3.4 Turbo Diesel | (BJ4../6../7..) | 80 → 89                           | Full-floating axle           |   | 190 256 190 256 |
| Landcruiser 3.4 Turbo Diesel | (BJ4../6../7..) | 80 → 89                           | Semi-floating axle           |   | 190 256 982 581 |
| Landcruiser 3.5 Diesel       | (PZJ7..)        | 90 → 04/95                        | {Front  } Full-floating axle |   | 981 533 982 811 |
| Landcruiser 3.5 Diesel       | (PZJ7..)        | 90 → 04/95                        | {Front  } Semi-floating axle |   | 981 533 982 581 |
| Landcruiser 3.5 Diesel       | (PZJ7..)        | 90 → 04/95                        | {Front  } Full-floating axle |   | 981 499 982 811 |
| Landcruiser 3.5 Diesel       | (PZJ7..)        | 90 → 04/95                        | {Front  } Semi-floating axle |   | 981 499 982 581 |
| Landcruiser 4.0              | (FJ80)          | 90 → 94                           | Semi-floating axle           |   | 190 256 982 581 |
| Landcruiser 4.0              | (FJ80)          | 90 → 03/93                        | {Front  } Semi-floating axle |   | 981 499 982 581 |
| Landcruiser 4.0 Diesel       | (HJ60)          | 80 → 89                           | Full-floating axle           |   | 190 256 190 256 |
| Landcruiser 4.0 Diesel       | (HJ60)          | 80 → 89                           | Semi-floating axle           |   | 190 256 982 581 |
| Landcruiser 4.0 Turbo Diesel | (HJ61)          | 80 → 89                           | Full-floating axle           |   | 190 256 190 256 |
| Landcruiser 4.0 Turbo Diesel | (HJ61)          | 80 → 89                           | Semi-floating axle           |   | 190 256 982 581 |
| Landcruiser 4.2 Diesel       | (HZJ80)         | 90 → 94                           | {Front  } Full-floating axle |   | 981 533 982 811 |
| Landcruiser 4.2 Diesel       | (HZJ80)         | 90 → 94                           | {Front  } Semi-floating axle |   | 981 533 982 581 |
| Landcruiser 4.2 Diesel       | (HZJ80)         | 90 → 94                           | {Front  } Full-floating axle |   | 981 499 982 811 |
| Landcruiser 4.2 Diesel       | (HZJ80)         | 90 → 94                           | {Front  } Semi-floating axle |   | 981 499 982 581 |
| Landcruiser 4.2 Diesel       | (HZJ7..)        | 90 → 04/95                        | {Front  } Full-floating axle |   | 981 533 982 811 |
| Landcruiser 4.2 Diesel       | (HZJ7..)        | 90 → 04/95                        | {Front  } Semi-floating axle |   | 981 533 982 581 |
| Landcruiser 4.2 Diesel       | (HZJ7..)        | 90 → 04/95                        | {Front  } Full-floating axle |   | 981 499 982 811 |
| Landcruiser 4.2 Diesel       | (HZJ7..)        | 90 → 04/95                        | {Front  } Semi-floating axle |   | 981 499 982 581 |
| Landcruiser 4.2 Turbo Diesel | (HDJ80)         | 90 → 97                           | {Front  } Full-floating axle |   | 981 533 982 811 |
| Landcruiser 4.2 Turbo Diesel | (HDJ80)         | 90 → 97                           | {Front  } Semi-floating axle |   | 981 533 982 581 |
| Landcruiser 4.2 Turbo Diesel | (HDJ80)         | 90 → 97                           | {Front  } Full-floating axle |   | 981 499 982 811 |
| Landcruiser 4.2 Turbo Diesel | (HDJ80)         | 90 → 97                           | {Front  } Semi-floating axle |   | 981 499 982 581 |





















| MODELL/MODEL/MODELE          |              |               |    | BEMERKUNGEN/REMARKS/<br>REMARQUES   |  |  |  |
|------------------------------|--------------|---------------|---|---|--|---|---|
| Landcruiser 4.2 Turbo Diesel | (HDJ100)     | 98 → 03       |    |   |  | 981 966   | 982 288   |
| Landcruiser 4.3              | (FJ40)       | 80 → 87       |    | Full-floating axle  |  | 190 256   | 190 256   |
| Landcruiser 4.3              | (FJ40)       | 80 → 87       |    | Semi-floating axle  |  | 190 256   | 982 581   |
| Landcruiser 4.3              | (FJ62)       | 08/87 → 02/89 |    | Full-floating axle  |  | 190 256   | 190 256   |
| Landcruiser 4.3              | (FJ62)       | 08/87 → 02/89 |    | Semi-floating axle  |  | 190 256   | 982 581   |
| Landcruiser 4.5i 24V         | (FZJ80)      | 90 → 98       |    | {Front  } Semi-floating axle |  | 981 499   | 982 581   |
| Landcruiser 4.7i V8 32V      | (UZJ100)     | 98 → 03       |    |   |  | 981 966   | 982 288   |
| Lite-Ace 1.3                 | (KM20)       | 10/79 → 01/85 |    |   |  | 981 814   | 982 764   |
| Lite-Ace 1.5                 | (KM30G)      | 09/85 → 01/92 |    |   |  | 981 447   | 982 685   |
| Lite-Ace 1.5                 | (KM31V/36V)  | 09/85 → 01/92 |    |   |  | 981 447   | 982 685   |
| Lite-Ace 1.5                 | (KM51)       | 10/86 → 04/94 |    |   |  | 981 447   | -   |
| Lite-Ace 1.5                 | (KR27)       | 92 → 01/94    |    |   |  | 981 447   | 982 764   |
| Lite-Ace 1.5                 | (KR41)       | 10/96 → 00    |    |   |  | 981 447   | 982 685   |
| Lite-Ace 1.8                 | (CM20)       | 83 → 01/85    |    |   |  | 981 814   | 982 764   |
| Lite-Ace 1.8                 | (YM30G/31V)  | 09/85 → 01/91 |    |   |  | 981 447   | 982 685   |
| Lite-Ace 1.8                 | (YM55)       | 10/86 → 10/96 |    |   |  | 981 447   | 982 685   |
| Lite-Ace 1.8                 | (YM60,YM65)  | 10/86 → 04/94 |    |   |  | 981 683   | 982 685   |
| Lite-Ace 1.8                 | (YR25)       | 92 → 01/94    |    |   |  | 981 447   | 982 764   |
| Lite-Ace 1.8                 | (KR42)       | 10/96 → 00    |   |   |  | 981 447   | 982 685   |
| Lite-Ace 2.0                 | (YM40G)      | 10/85 → 01/92 |  |   |  | 981 683   | 982 685   |
| Lite-Ace 2.0                 | (YR21G)      | 92 → 10/96    |  | ABS   |  | 981 447   | 982 685   |
| Lite-Ace 2.0                 | (YR30G)      | 92 → 01/94    |  |   |  | 981 683   | 982 685   |
| Lite-Ace 2.0 Diesel          | (CR21G)      | 92 → 09/93    |  | ABS   |  | 981 447   | 982 764   |
| Lite-Ace 2.0 Diesel          | (CR27V/28G)  | 92 → 09/93    |  |   |  | 981 447   | 982 764   |
| Lite-Ace 2.0 Diesel          | (CR30G/36G)  | 92 → 01/94    |  |   |  | 981 683   | 982 685   |
| Lite-Ace 2.0 Diesel          | (CR37G)      | 92 → 01/94    |  |   |  | 981 683   | 982 685   |
| Lite-Ace 2.0 Diesel          | (CM30G)      | 09/85 → 01/92 |  |   |  | 981 447   | -   |
| Lite-Ace 2.0 Diesel          | (CM31V/36V)  | 09/85 → 01/92 |  |   |  | 981 447   | 982 685   |
| Lite-Ace 2.0 Diesel          | (CM40G/41V)  | 09/85 → 01/92 |  |   |  | 981 683   | 982 685   |
| Lite-Ace 2.0 Diesel          | (CM51)       | 10/86 → 09/96 |  |   |  | 981 447   | -   |
| Lite-Ace 2.0 Diesel          | (CM52)       | 10/91 → 04/94 |  |   |  | 981 683   | -   |
| Lite-Ace 2.0 Diesel          | (CM55)       | 04/94 → 00    |  |   |  | 981 447   | -   |
| Lite-Ace 2.0 Diesel          | (CM60,CM65)  | 10/86 → 04/94 |  |   |  | 981 683   | 982 685   |
| Lite-Ace 2.0 Diesel          | (CM61)       | 10/91 → 04/94 |  |   |  | 981 683   | -   |
| Lite-Ace 2.2 Diesel          | (CR31G/38G)  | 09/93 → 01/94 |  |   |  | 981 683   | 982 685   |
| Lite-Ace 2.2 Diesel          | (CR22G/29G)  | 09/93 → 09/96 |  |   |  | 981 447   | 982 764   |
| Toyo-Ace                     | (RY20, RY30) | 03/79 → 07/85 |  | Full-floating axle  |  | -   | 982 581   |
| Toyo-Ace                     | (RY30)       | 09/84 → 07/85 |  | Semi-floating axle  |  | -   | 190 256   |



























**MODELL/MODEL/MODELE**

























**BEMERKUNGEN/REMARKS/  
REMARQUES**



|         |         |                    |                |                |
|---------|---------|--------------------|----------------|----------------|
| Acclaim | 81 → 82 | Ch.→117812 R.H.D   | -              | <b>912 515</b> |
| Acclaim | 82 → 84 | Ch.117813→ R.H.D   | -              | <b>912 515</b> |
| Acclaim | 82 → 84 | Ch.113051→ L.H.D   | -              | <b>912 515</b> |
| TR 7    | 75 → 82 | Man.GBX 5          | <b>880 525</b> | <b>882 531</b> |
| TR 7    | 79 → 80 | Aut.GBX Ch.→402000 | <b>880 525</b> | -              |
| TR 7    | 80 → 82 | Aut.GBX Ch.402001→ | <b>880 525</b> | <b>882 531</b> |







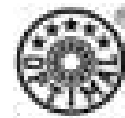





| MODELL/MODEL/MODELE                       |  | BEMERKUNGEN/REMARKS/<br>REMARQUES   |  |  |
|---|---|---|---|---|
| Agila                                     | 00 → 04   |   | 201 087   | 202 224   |
| Astra 1.0                                 | 80 → 84   |   | 201 040   | 200 012   |
| Astra 1.2                                 | 80 → 84   |   | 201 040   | 200 012   |
| Astra 1.2                                 | 85 → 91   |   | 201 040   | 200 012   |
| Astra 1.3                                 | 80 → 84   |   | 201 040   | 200 012   |
| Astra 1.3                                 | 85 → 91   |   | 201 040   | 200 012   |
| Astra 1.4                                 | 85 → 91   |   | 201 040   | 200 012   |
| Astra 1.6                                 | 83 → 84   |   | 201 032   | 200 012   |
| Astra 1.6D, 1.6DA, 1.6S                   | 85 → 91   |   | 201 032   | 200 012   |
| Astra 1.6LZ, 1.6NZ, 1.6SV                 | 85 → 91   |   | 201 040   | 200 012   |
| Astra 1.7 Diesel                          | 85 → 91   |   | 201 032   | 200 012   |
| Astra 1.8                                 | 83 → 84   |   | 201 032   | 200 012   |
| Astra 1.8, 2.0                            | 85 → 91   |   | 201 032   | 200 012   |
| Astra Mk III 1.4, 1.6                     | 92 → 98   | <del>ABS</del> {Front  34x64x37}   | 201 040   | 202 140   |
| Astra Mk III 1.4, 1.6                     | 92 → 98   | <del>ABS</del> {Front  34x66x37}   | 201 210   | 202 140   |
| Astra Mk III 1.4, 1.6                     | 92 → 98   | <del>ABS</del> {Front  39x72x37}   | 201 032   | 202 140   |
| Astra Mk III 1.4, 1.6                     | 92 → 98   | <del>ABS</del> {Front  39x74x39}   | 201 228   | 202 140   |
| Astra Mk III 1.4, 1.6                     | 92 → 98   | ABS {Front  34x64x37}              | 201 040   | 202 142   |
| Astra Mk III 1.4, 1.6                     | 92 → 98   | ABS {Front  34x66x37}              | 201 210   | 202 142   |
| Astra Mk III 1.4, 1.6                     | 92 → 98   | ABS {Front  39x72x37}              | 201 032   | 202 142   |
| Astra Mk III 1.4, 1.6                     | 92 → 98   | ABS {Front  39x74x39}              | 201 228   | 202 142   |
| Astra Mk III 1.7 Diesel, 1.7 Turbo Diesel | 92 → 98   | <del>ABS</del> {Front  39x72x37}   | 201 032   | 202 140   |
| Astra Mk III 1.7 Diesel, 1.7 Turbo Diesel | 92 → 98   | <del>ABS</del> {Front  39x74x39}  | 201 228   | 202 140   |
| Astra Mk III 1.7 Diesel, 1.7 Turbo Diesel | 92 → 98   | ABS {Front  39x72x37}            | 201 032   | 202 142   |
| Astra Mk III 1.7 Diesel, 1.7 Turbo Diesel | 92 → 98   | ABS {Front  39x74x39}            | 201 228   | 202 142   |
| Astra Mk III 1.8, 2.0                     | 92 → 98   | <del>ABS</del> {Front  39x72x37} | 201 032   | 202 140   |
| Astra Mk III 1.8, 2.0                     | 92 → 98   | <del>ABS</del> {Front  39x74x39} | 201 228   | 202 140   |
| Astra Mk III 1.8, 2.0                     | 92 → 98   | ABS {Front  39x72x37}            | 201 032   | 202 142   |
| Astra Mk III 1.8, 2.0                     | 92 → 98   | ABS {Front  39x74x39}            | 201 228   | 202 142   |
| Astra Mk IV 1.2 16V                       | 98 → 00   | <del>ABS</del>  | 201 033   | 202 140   |
| Astra Mk IV 1.2 16V                       | 98 → 00   | ABS   | 201 035   | 202 142   |
| Astra Mk IV 1.4 16V                       | 98 → 04   | <del>ABS</del>  | 201 033   | 202 140   |
| Astra Mk IV 1.4 16V                       | 98 → 04   | ABS   | 201 035   | 202 142   |
| Astra Mk IV 1.6                           | 98 → 00   | <del>ABS</del>  | 201 033   | 202 140   |
| Astra Mk IV 1.6                           | 98 → 00   | ABS   | 201 035   | 202 142   |
| Astra Mk IV 1.6 16V                       | 98 → 04   | <del>ABS</del>  | 201 033   | 202 140   |
| Astra Mk IV 1.6 16V                       | 98 → 04   | ABS   | 201 035   | 202 142   |
| Astra Mk IV 1.7 TD                        | 98 → 00   | <del>ABS</del>  | 201 033   | 202 140   |
| Astra Mk IV 1.7 TD                        | 98 → 00   | ABS   | 201 035   | 202 142   |
| Astra Mk IV 1.7 DTI 16V                   | 00 → 04   | <del>ABS</del>  | 201 033   | 202 140   |
| Astra Mk IV 1.7 DTI 16V                   | 00 → 04   | ABS   | 201 035   | 202 142   |
| Astra Mk IV 1.8 16V                       | 98 → 00   | <del>ABS</del>  | 201 033   | 202 140   |
| Astra Mk IV 1.8 16V                       | 98 → 00   | ABS   | 201 043   | 202 218   |
| Astra Mk IV 1.8 16V Coupé                 | 00 → 00   | <del>ABS</del>  | 201 031   | 202 059   |
| Astra Mk IV 1.8 16V Coupé                 | 00 → 00   | ABS   | 201 043   | 202 218   |
| Astra Mk IV 2.0 16V                       | 98 → 04   | <del>ABS</del>  | 201 031   | 202 059   |
| Astra Mk IV 2.0 16V                       | 98 → 04   | ABS   | 201 043   | 202 218   |
| Astra Mk IV 2.0 DI 16V                    | 98 → 99   | <del>ABS</del> Man.GBX F18  | 201 035   | 202 140   |
| Astra Mk IV 2.0 DI 16V                    | 00 → 04   | <del>ABS</del> Man.GBX F18  | 201 033   | 202 140   |
| Astra Mk IV 2.0 DI 16V                    | 98 → 04   | <del>ABS</del> Man.GBX F23  | 201 033   | 202 140   |
| Astra Mk IV 2.0 DI 16V                    | 98 → 04   | <del>ABS</del> Aut.GBX  | 201 033   | 202 140   |
| Astra Mk IV 2.0 DI 16V                    | 98 → 04   | ABS   | 201 043   | 202 218   |
| Astra Mk IV 2.0 DTI 16V                   | 98 → 04   | <del>ABS</del>  | 201 031   | 202 059   |
| Astra Mk IV 2.0 DTI 16V                   | 98 → 04   | ABS   | 201 043   | 202 218   |

























































































































| MODELL/MODEL/MODELE                   | BEMERKUNGEN/REMARKS/<br>REMARQUES |   |   |  |  |
|---------------------------------------|-----------------------------------|---|---|---|---|
| Astra Mk V                            | 03/04                             | → | 05  x4 | 201 621   | 202 625   |
| Astra Mk V                            | 03/04                             | → | 05  x5 | 201 623   | 202 627   |
| Astra Classic                         | 99                                | → | 02 <del>ABS</del>   | 201 210   | 202 140   |
| Astra Classic                         | 99                                | → | 02 ABS  | 201 210   | 202 142   |
| Belmont 1.2                           | 86                                | → | 91  | 201 040   | 200 012   |
| Belmont 1.3                           | 86                                | → | 91  | 201 040   | 200 012   |
| Belmont 1.4                           | 86                                | → | 91  | 201 040   | 200 012   |
| Belmont 1.6 LZ, 1.6 NZ, 1.6 SV        | 86                                | → | 91  | 201 040   | 200 012   |
| Belmont 1.6 S                         | 86                                | → | 91  | 201 032   | 200 012   |
| Belmont 1.6 Diesel                    | 86                                | → | 91  | 201 032   | 200 012   |
| Belmont 1.7 Diesel                    | 86                                | → | 91  | 201 032   | 200 012   |
| Belmont 1.8                           | 86                                | → | 91  | 201 032   | 200 012   |
| Belmont 2.0                           | 86                                | → | 91  | 201 032   | 200 012   |
| Calibra C20NE, C20XE, X20XEV          | 89                                | → | 95  | 201 032   | 202 168   |
| Calibra C20NE, X20XEV                 | 96                                | → | 97  | 201 228   | 202 168   |
| Calibra C20XE                         | 96                                | → | 97     | 201 032   | 202 168   |
| Calibra C20XE                         | 96                                | → | 97     | 201 228   | 202 168   |
| Calibra C20LET                        | 89                                | → | 92  | 201 032   | 202 168   |
| Calibra C20LET                        | 93                                | → | 97  | 201 228   | 202 168   |
| Calibra C25XE, X25XE                  | 93                                | → | 97  | 201 228   | 202 168   |
| Carlton                               | 79                                | → | 86     | 200 012   | 202 202   |
| Carlton Diesel                        | 79                                | → | 86     | 200 020   | 202 204   |
| Carlton 1.8                           | 87                                | → | 93    | 201 084   | 202 026   |
| Carlton 1.8                           | 87                                | → | 93   | 201 084   | 202 168   |
| Carlton 2.0                           | 87                                | → | 93   | 201 084   | 202 026   |
| Carlton 2.0                           | 87                                | → | 93   | 201 084   | 202 168   |
| Carlton 2.3 Diesel                    | 87                                | → | 93   | 201 084   | 202 026   |
| Carlton 2.3 Diesel                    | 87                                | → | 93   | 201 084   | 202 168   |
| Carlton 2.3 Turbo Diesel              | 87                                | → | 93  | 201 084   | 202 168   |
| Carlton 2.4                           | 87                                | → | 93  | 201 084   | 202 168   |
| Carlton 2.6                           | 87                                | → | 93  | 201 084   | 202 168   |
| Carlton 3.0                           | 87                                | → | 93  | 201 084   | 202 168   |
| Carlton 3.6 24V Lotus                 | 90                                | → | 93  | 201 084   | 202 168   |
| Cavalier 1300                         | 76                                | → | 81  | 200 012   | -   |
| Cavalier 1600, 1900                   | 76                                | → | 81  | 200 012   | 202 236   |
| Cavalier 1.3                          | 82                                | → | 88   | 201 040   | 200 012   |
| Cavalier 1.3                          | 82                                | → | 88   | 201 040   | 202 065   |
| Cavalier 1.4                          | 89                                | → | 93  | 201 040   | 200 012   |
| Cavalier 1.6 NS, 1.6 SH               | 82                                | → | 88   | 201 032   | 200 012   |
| Cavalier 1.6 NS, 1.6 SH               | 82                                | → | 88   | 201 032   | 202 065   |
| Cavalier 1.6 NZ, 1.6 SV               | 82                                | → | 88   | 201 040   | 200 012   |
| Cavalier 1.6 NZ, 1.6 SV               | 82                                | → | 88   | 201 040   | 202 065   |
| Cavalier 1.6 Diesel                   | 82                                | → | 88   | 201 032   | 200 012   |
| Cavalier 1.6 Diesel                   | 82                                | → | 88   | 201 032   | 202 065   |
| Cavalier 1.6                          | 89                                | → | 93 Man.GBX  | 201 040   | 200 012   |
| Cavalier 1.6 Automatic                | 89                                | → | 93 Aut.GBX  | 201 032   | 200 012   |
| Cavalier 1.6                          | 94                                | → | 95  | 201 210   | 200 012   |
| Cavalier 1.7 Diesel                   | 82                                | → | 88   | 201 032   | 202 065   |
| Cavalier 1.7 Diesel, 1.7 Turbo Diesel | 89                                | → | 95  | 201 032   | 200 012   |
| Cavalier 1.8                          | 82                                | → | 88   | 201 032   | 200 012   |
| Cavalier 1.8                          | 82                                | → | 88   | 201 032   | 202 065   |
| Cavalier 1.8                          | 89                                | → | 95  | 201 032   | 200 012   |
| Cavalier 2.0                          | 82                                | → | 88   | 201 032   | 202 065   |
| Cavalier 2.0 NE, 2.0 SEH              | 89                                | → | 95  | 201 032   | 200 012   |

| MODELL/MODEL/MODELE     |  | BEMERKUNGEN/REMARKS/<br>REMARQUES  |  |  |
|-------------------------|---|--|---|---|
| Cavalier 2.0 XE 16V     | 92 → 95   |  | 201 032   | 202 168   |
| Cavalier 2.0i Turbo 4x4 | 92 → 92   |  | 201 032   | 202 168   |
| Cavalier 2.0i Turbo 4x4 | 93 → 94   |  | 201 228   | 202 168   |
| Cavalier 2.5 XE V6      | 93 → 95   |  | 201 228   | 202 218   |
| Cavalier 2.5 XE V6 4x4  | 95 → 95   |  | 201 228   | 202 168   |
| Chevette                | 77 → 84   |  | 200 012   | -   |
| Corsa Mk I              | 93 → 09/00  |  | 201 210   | 200 012   |
| Corsa Mk I Combo        | 93 → 09/00  |  | 201 210   | 200 020   |
| Corsa Mk II             | 10/00 → 05  | {Rear  }            | 201 095   | 202 021   |
| Corsa Mk II             | 10/00 → 05  | {Rear  }            | 201 095   | 202 023   |
| Corsa Mk II Combo       | 10/00 → 05  | <del>ABS</del>   | 201 095   | 202 140   |
| Corsa Mk II Combo       | 10/00 → 05  | ABS  | 201 095   | 202 142   |
| Frontera                | 91 → 04   |  | 201 262   | 202 155   |
| Meriva 1.3 CDTI         | 03 → 05   | <del>ABS</del>  x4  | 201 095   | 202 140   |
| Meriva 1.3 CDTI         | 03 → 05   | ABS  x4             | 201 095   | 202 142   |
| Meriva 1.4 16V Twinport | 04 → 05   | <del>ABS</del>  x4  | 201 095   | 202 140   |
| Meriva 1.4 16V Twinport | 04 → 05   | ABS  x4             | 201 095   | 202 142   |
| Meriva 1.6, 1.6 16V     | 03 → 05   | <del>ABS</del>  x4  | 201 095   | 202 140   |
| Meriva 1.6, 1.6 16V     | 03 → 05   | ABS  x4             | 201 095   | 202 142   |
| Meriva 1.7 DTI          | 03 → 05   | <del>ABS</del>  x4  | 201 095   | 202 140   |
| Meriva 1.7 DTI          | 03 → 05   | ABS  x4             | 201 095   | 202 142   |
| Meriva 1.7 CDTI         | 03 → 05   | ABS  x5             | 201 032   | 202 218   |
| Meriva 1.8              | 03 → 05   | <del>ABS</del>  x4 | 201 095   | 202 140   |
| Meriva 1.8              | 03 → 05   | ABS  x4           | 201 095   | 202 142   |
| Monterey I 3.1 TD       | 91 → 98   |  | 201 262   | 932 864   |
| Monterey I 3.2i V6 24V  | 91 → 98   |  | 201 262   | 932 864   |
| Monterey II 3.0 TDI 16V | 98 → 99   |  | 201 262   | 932 864   |
| Monterey II 3.5i V6 26V | 98 → 99   |  | 201 262   | 932 864   |
| Nova                    | 83 → 92   |  | 201 040   | 200 012   |
| Omega                   | 94 → 03   |  | 201 084   | 201 228   |
| Omega Caravan           | 94 → 03   |  | 201 084   | 202 168   |
| Royal                   | 79 → 82   |  | 200 020   | 202 226   |
| Senator 2.5i            | 88 → 93   |  | 201 084   | 202 168   |
| Senator 3.0i            | 88 → 93   |  | 201 084   | 202 168   |
| Signum                  | 03 → 01/05  | Ch.→41999999   | 201 517   | 202 519   |
| Signum                  | 01/05 → 06  | Ch.51000001→   | 201 691   | 202 519   |
| Sintra                  | 96 → 99   |  | 201 671   | 202 673   |
| Tigra                   | 94 → 05/04  |  | 201 210   | 200 012   |
| Vectra Mk I 1.6         | 96 → 98   |  x4               | 201 228   | 202 142   |
| Vectra Mk I 1.7 TD      | 96 → 98   |  x4               | 201 228   | 202 142   |
| Vectra Mk I 1.8 16V     | 96 → 98   |  x4               | 201 228   | 202 142   |
| Vectra Mk I 2.0         | 96 → 98   |  x4               | 201 228   | 202 142   |
| Vectra Mk I 2.0 16V     | 96 → 98   |  x5               | 201 228   | 202 218   |
| Vectra Mk I 2.0 DI 16V  | 96 → 98   |  x4               | 201 228   | 202 142   |
| Vectra Mk I 2.0 DTI 16V | 96 → 98   |  x4               | 201 228   | 202 142   |
| Vectra Mk I 2.5i V6     | 96 → 98   |  x5               | 201 228   | 202 218   |
| Vectra Mk I             | 99 → 03/02  |  x5               | 201 228   | 202 218   |
| Vectra Mk II            | 02 → 01/05  | Ch.→41999999   | 201 517   | 202 519   |
| Vectra Mk II            | 01/05 → 06  | Ch.51000001→   | 201 691   | 202 519   |
| Viceroy                 | 80 → 82   |  | 200 020   | 202 204   |
| VX 220 2.0i Turbo       | 03 → 05   |  | 201 043   | 201 043   |
| VX 220 2.2i             | 00 → 05   |  | 201 043   | 201 043   |
| Zafira                  | 99 → 04   | <del>ABS</del>   | 201 031   | 202 059   |
| Zafira                  | 99 → 04   | ABS  | 201 043   | 202 218   |































| MODELL/MODEL/MODELE |  | BEMERKUNGEN/REMARKS/<br>REMARQUES   |  |  |
|---------------------|---|---|---|---|
| Astramax 1.2 S      | 86 → 90   |                              | 201 040   | 200 020   |
| Astramax 1.3        | 86 → 90   |                              | 201 040   | 200 020   |
| Astramax 1.6 S      | 86 → 90   |                              | 201 032   | 200 020   |
| Astramax Diesel     | 86 → 90   |                              | 201 032   | 200 020   |
| Movano              | 98 → 05   |                              | 701 860   | 702 846   |
| Brava 4x4 (TFS)     | 91 → 95   |                              | 201 262   | -   |
| Rascal              | 87 → 87   |                              | 971 567   | 972 573   |
| Vivaro              | 01 → 05   |  ABS                         | 201 085   | 202 101   |
| Vivaro              | 01 → 05   |  ABS - Active Sensor Bearing | 201 089   | 202 101   |

| MODELL/MODEL/MODELE       |  | BEMERKUNGEN/REMARKS/<br>REMARQUES  |  |  |
|---------------------------|---|--|---|---|
| Bora                      | 99 → 05   |  | 101 113   | 102 115   |
| Bora                      | 99 → 02   |  | 04-P159   | -   |
| Bora 4 Motion             | 99 → 05   |  | 101 113   | 101 113   |
| Bora 4 Motion             | 99 → 02   |  | 04-P159   | -   |
| Bora                      | 99 → 02   |  | 04-P159   | -   |
| Caddy I                   | 83 → 94   |  | 101 010   | 102 008   |
| Caddy                     | 83 → 92   |   | 04-P103   | -   |
| Caddy II                  | 95 → 97   | Ch.→9KW503258  | 100 022   | 102 008   |
| Caddy                     | 95 → 01   |  ABS  | 04-P101   | -   |
| Caddy II                  | 97 → 04/99  | Ch.9KW503259→Ch.9KY500748  | 100 022   | 102 055   |
| Caddy                     | 95 → 01   |  ABS  | 04-P109   | -   |
| Caddy II                  | 04/99 → 04  | Ch.9KY500749→ ABS  | 100 022   | 102 079   |
| Caddy II                  | 04/99 → 04  | Ch.9KY500749→ ABS  | 100 022   | 102 158   |
| Caddy II Pick-up          | 97 → 01   |  | 801 543   | 100 002   |
| Caddy III                 | 03/04 → 06  |  280 mm   | 101 017   | 102 019   |
| Caddy III                 | 03/04 → 06  |  280 mm   | 101 699   | 102 019   |
| Corrado                   | 89 → 95   |  ABS  | 04-P101   | -   |
| Corrado                   | 89 → 95   |  ABS  x4     | 04-P109   | -   |
| Corrado 2.9 VR6           | 89 → 95   |  ABS  x5     | 04-P111   | -   |
| Corrado 1.8               | 89 → 95   |  | 100 022   | 100 002   |
| Derby                     | 77 → 90   |   | 04-P107   | -   |
| Corrado 2.0               | 91 → 95   |  | 100 022   | 100 002   |
| Corrado 2.9 VR6           | 91 → 95   |  | 101 024   | 100 002   |
| Eos                       | 05/06 → 07  |  | 101 017   | 102 019   |
| Golf I                    | 77 → 84   |  Ch.→E29999   | 04-P103   | -   |
| Golf II, III              | 88 → 97   |  ABS  | 04-P101   | -   |
| Golf II, III              | 88 → 97   |  ABS  x4 | 04-P109   | -   |
| Golf III 2.0 GTI, 2.8 VR6 | 92 → 97   |  ABS  x5 | 04-P111   | -   |
| Golf II, III              | 84 → 97   |  ABS  | -   | 04-P010   |
| Golf III                  | 92 → 97   |  ABS     | -   | 04-P006   |
| Golf III                  | 92 → 97   |  ABS     | -   | 04-P008   |
| Golf III                  | 92 → 97   |  ABS     | -   | 04-P002   |
| Golf III                  | 92 → 97   |  ABS     | -   | 04-P004   |
| Golf Cabriolet            | 79 → 08/93  |   | 04-P103   | -   |
| Golf Cabriolet            | 09/93 → 01  |   | 04-P109   | -   |
| Golf Cabriolet            | 94 → 98   |  ABS  | -   | 04-P010   |
| Golf Cabriolet            | 94 → 98   |  ABS     | -   | 04-P006   |
| Golf Cabriolet            | 94 → 98   |  ABS     | -   | 04-P008   |
| Golf Cabriolet            | 94 → 01   |  ABS     | -   | 04-P002   |
| Golf Cabriolet            | 94 → 01   |  ABS     | -   | 04-P004   |
| Golf Syncro               | 88 → 91   |  ABS  | 04-P101   | -   |
| Golf Syncro               | 88 → 91   |  ABS  | 04-P109   | -   |
| Golf Syncro               | 93 → 98   |  ABS  x4 | 04-P109   | -   |
| Golf Syncro 2.9 VR6       | 93 → 98   |  ABS  x5 | 04-P111   | -   |
| Golf Syncro               | 86 → 91   |   | -   | 04-P105   |
| Golf Syncro               | 93 → 98   |  Cyl 4  | -   | 04-P105   |
| Golf Variant              | 92 → 99   |  ABS  | 04-P101   | -   |
| Golf Variant              | 92 → 99   |  ABS  | 04-P109   | -   |
| Golf Variant              | 94 → 98   |  ABS  | -   | 04-P010   |
| Golf Variant              | 94 → 98   |  ABS     | -   | 04-P006   |
| Golf Variant              | 94 → 98   |  ABS     | -   | 04-P008   |
| Golf Variant              | 94 → 98   |  ABS     | -   | 04-P002   |
| Golf Variant              | 94 → 98   |  ABS     | -   | 04-P004   |
| Golf/Variant/4 Motion     | 98 → 02   |  | 04-P159   | -   |

| MODELL/MODEL/MODELE                      |  | BEMERKUNGEN/REMARKS/<br>REMARQUES   |  |  |
|--|---|---|---|---|
| Derby                                    | 77 → 90   |   | 101 044   | 100 002   |
| Jetta                                    | 79 → 84   |  Ch.→16E29999  | 04-P103   | -   |
| Jetta                                    | 88 → 92   |  ABS   | 04-P101   | -   |
| Jetta                                    | 88 → 92   |  ABS   | 04-P109   | -   |
| Jetta                                    | 87 → 92   |   ABS   | -   | 04-P010   |
| Jetta Syncro                             | 88 → 91   |  ABS   | 04-P101   | -   |
| Jetta Syncro                             | 88 → 91   |  ABS   | 04-P109   | -   |
| Jetta Syncro                             | 88 → 91   |     | -   | 04-P105   |
| EOS                                      | 03/06 → 06  |   | 101 017   | 102 213   |
| Fox 1.2, 1.4, 1.4 TDi                    | 04/05 → 06  |   | 101 027   | 102 077   |
| Passat                                   | 74 → 03/88  |  Ch.→32J299999   | 04-P105   | -   |
| Passat                                   | 04/88 → 02/92   |  ABS   | 04-P101   | -   |
| Passat                                   | 04/88 → 02/92   |  ABS  x4  | 04-P109   | -   |
| Passat                                   | 88 → 97   |  Ch.→3AV300000  ABS   | -   | 04-P010   |
| Passat                                   | 88 → 97   |  Ch.→3AV300000  ABS        | -   | 04-P008   |
| Passat                                   | 88 → 97   |  Ch.→3AV300000  ABS        | -   | 04-P002   |
| Passat                                   | 88 → 97   |  Ch.→3AV300000  ABS        | -   | 04-P004   |
| Passat                                   | 03/92 → 97  |  ABS  x4 Ch.→3AV300000  | 04-P109   | -   |
| Passat                                   | 88 → 97   |  Ch.→3AV300000  ABS        | -   | 04-P006   |
| Passat                                   | AD...,AEB,AFY,AGZ,AH..  | 97 → 00 Ch.3B-V-000001-->, 5 [11]   | 04-P179   | -   |
| Passat                                   | ACK,AFN,AGE,AGZ   | 97 → 00 Ch.3B-V-000001-->, 5 [11]   | 04-P157   | -   |
| Passat                                   | ALT,ALZ,AVB,AZM   | 01 → 04   | 04-P179   | -   |
| Passat 2.0 16V 110 kW, 2.8 VR6           | 03/92 → 97  |  ABS  x5 Ch.31N255990→3AV300000   | 04-P111   | -   |
| Passat 1.9 TDI 81kW                      | 03/92 → 97  |  ABS  x5 Ch.31N255990→3AV300000   | 04-P111   | -   |
| Passat Syncro                            | 85 → 06/91  |  ABS Ch.→31M367757   | -   | 04-P105   |
| Passat Syncro 2.0                        | 89 → 97   |  Ch.31M36758→4AV012704   | -   | 04-P101   |
| Passat Syncro 2.0                        | 89 → 93   |  ABS   | 04-P109   | -   |
| Passat Syncro 2.0                        | 94 → 05/97  |  ABS  x4 Ch.→3AV012704  | 04-P109   | -   |
| Passat Syncro 2.9 VR6                    | 94 → 97   |  ABS  x5 Ch.→3AV012704  | 04-P111   | -   |
| Golf I                                   | 74 → 84   | Ch.→E299999   | 101 010   | 100 002   |
| Polo                                     | 75 → 07/94  |    | 04-P107   | -   |
| Golf II                                  | 84 → 87   | Ch.E300001→   | 101 016   | 100 002   |
| Golf II                                  | 88 → 91   |   | 100 022   | 100 002   |
| Golf II Syncro                           | 86 → 87   |   | 101 016   | 100 014   |
| Golf II Syncro                           | 88 → 91   |   | 100 022   | 100 014   |
| Golf III 1.4, 1.6, 1.8                   | 92 → 98   |   | 100 022   | 100 002   |
| Polo                                     | 91 → 99   |  Ch.→6NXY37991  ABS   | -   | 04-P010   |
| Polo                                     | 95 → 99   |  Ch.→6NXY37991  ABS  | -   | 04-P006   |
| Golf III 1.9 D, 1.9 TD, 1.9 TDI, 1.9 SDI | 92 → 98   |   | 100 022   | 100 002   |
| Polo                                     | 95 → 99   |  Ch.→6NXY37991  ABS  | -   | 04-P008   |
| Golf III 1.9, 2.0                        | 92 → 98   |   | 100 022   | 100 002   |
| Golf III 1.9 GTI, 2.0 GTI                | 92 → 98   |   | 101 024   | 100 002   |
| Polo                                     | 95 → 99   |  Ch.→6NXY37991  ABS  | -   | 04-P002   |
| Golf III 2.8 VR6                         | 92 → 98   |   | 101 024   | 100 002   |
| Polo                                     | 95 → 99   |  Ch.→6NXY37991  ABS  | -   | 04-P004   |
| Golf III Syncro 1.8, 1.9 TDI, 2.0        | 93 → 98   |   | 100 022   | 100 014   |
| Polo Classic/Variant                     | 96 → 01   |  ABS   | 04-P101   | -   |
| Golf III Syncro 2.9 VR6                  | 93 → 98   |   | 101 024   | 100 022   |
| Polo Classic/Variant                     | 96 → 01   |  ABS   | 04-P109   | -   |
| Golf III Variant                         | 92 → 98   |   | 100 022   | 100 002   |
| Golf IV                                  | 98 → 04   |   | 101 113   | 102 115   |
| Polo Classic/Variant                     | 96 → 99   |  Ch.→6KX610000  ABS   | -   | 04-P010   |
| Golf IV 4 Motion                         | 98 → 04   |   | 101 113   | 101 113   |
| Polo Classic/Variant                     | 96 → 99   |  Ch.→6KX610000  ABS  | -   | 04-P006   |



| MODELL/MODEL/MODELE            |               |   | BEMERKUNGEN/REMARKS/<br>REMARQUES   |  |  |
|--------------------------------|---------------|---|---|---|---|
| Polo Classic/Variant           | 96 → 99       |   | Ch.→6KX610000  ABS  | -   | 04-P008   |
| Polo Classic/Variant           | 97 → 99       |   | Ch.→6KX610000  ABS  | -   | 04-P002   |
| Polo Classic/Variant           | 97 → 99       |   | Ch.→6KX610000  ABS  | -   | 04-P004   |
| Golf V                         | 03 → 05       |    |   | -   | 102 009   |
| Golf V                         | 10/03 → 12/03 |   | Ch.→8P-4-162000   | 101 017   | 102 019   |
| Golf V                         | 12/03 → 06    |   | Ch.8P-4-162001→  280 mm  | 101 699   | 102 213   |
| Golf V                         | 12/03 → 06    |   | Ch.8P-4-162001→  <del>280 mm</del>   | 101 017   | 102 213   |
| Golf V 4 Motion                | 04 → 06       |   |   | 101 017   | 101 017   |
| Golf Cabriolet                 | 79 → 08/93    |   |   | 101 010   | 100 002   |
| Golf Cabriolet                 | 09/93 → 04    |   |   | 100 022   | 100 002   |
| Jetta                          | 79 → 84       |   | Ch.→16E299999   | 101 010   | 100 002   |
| Santana                        | 82 → 85       |    |   | 04-P105   | -   |
| Jetta                          | 84 → 87       |   | Ch.16E300001→   | 101 016   | 100 002   |
| Jetta                          | 88 → 92       |   |   | 100 022   | 100 002   |
| Jetta Syncro                   | 88 → 91       |   |   | 100 022   | 100 014   |
| Jetta III (1K2)                | 08/05 → 06    |   |   | 101 017   | 102 213   |
| Lupo 1.0                       | 99 → 06       |   |   | 101 016   | 102 075   |
| Scirocco                       | 77 → 92       |    |   | 04-P103   | -   |
| Lupo 1.2 TDI 3L                | 99 → 06       |   | ABS - Active Sensor Bearing   | 101 029   | 102 069   |
| Lupo 1.4, 1.4 16V, 1.4 FSI     | 99 → 06       |   |   | 101 016   | 102 075   |
| Lupo 1.4 TDI, 1.6 GTI, 1.7 SDI | 99 → 06       |   |   | 101 016   | 102 075   |
| New Beetle                     | 98 → 06       |   |   | 101 113   | 102 115   |
| Vento                          | 92 → 98       |   | ABS   | 04-P101   | -   |
| New Beetle                     | 99 → 02       |   | with ABS ring, 3.2 RSI  | 04-P159   | -   |
| New Beetle 4 Motion            | 00 → 06       |   |   | 101 113   | 101 113   |
| Vento                          | 92 → 98       |  | ABS  x4  | 04-P109   | -   |
| Vento 2.0 GTI, 2.8 VR6         | 92 → 98       |  | ABS  x5  | 04-P111   | -   |
| Vento                          | 92 → 98       |  | ABS    | -   | 04-P010   |
| Vento                          | 92 → 98       |  | ABS    | -   | 04-P006   |
| Vento                          | 92 → 98       |  | ABS    | -   | 04-P008   |
| Vento                          | 92 → 98       |  | ABS    | -   | 04-P002   |
| Vento                          | 92 → 98       |  | ABS    | -   | 04-P004   |
| Passat                         | 74 → 03/88    |   | Ch.3242310590→32J299999   | 100 014   | 100 002   |
| Passat 1.6                     | 04/88 → 97    |   | Ch.31J000001→3AV300000  | 100 022   | 100 002   |
| Passat 1.6                     | 97 → 04       |   | Ch.3BV000001→   | 100 091   | 102 011   |
| Passat 1.8                     | 04/88 → 97    |   | Ch.31J000001→3AV300000  | 100 022   | 100 002   |
| Passat 1.8                     | 97 → 04       |   | Ch.3BV000001→   | 100 091   | 102 011   |
| Passat 1.9 D                   | 04/88 → 10/93 |   |   | 100 022   | 100 002   |
| Passat 1.9 TD                  | 03/91 → 96    |   |   | 100 022   | 100 002   |
| Passat 1.9 TDI 66 kW           | 10/93 → 97    |   | Ch.→3AV300000   | 100 022   | 100 002   |
| Passat 1.9 TDI 66 kW           | 97 → 00       |   | Ch.3BV000001→   | 100 091   | 102 011   |
| Passat 1.9 TDI 81 kW           | 92 → 97       |   | Ch.31N255990→3AV300000  | 101 024   | 100 002   |
| Passat 1.9 TDI 81 kW           | 97 → 00       |   | Ch.3BV000001→   | 100 098   | 102 011   |
| Passat 1.9 TDI 85 kW           | 98 → 11/00    |   | Ch.→3BY390000   | 100 090   | 102 011   |
| Passat 1.9 TDI 85 kW           | 11/00 → 05    |   | Ch.3BY390001→   | 100 098   | 102 011   |
| Passat 2.0                     | 79 kW 90 → 96 |   |   | 100 022   | 100 002   |
| Passat 2.0                     | 85 kW 90 → 97 |   |   | 100 022   | 100 002   |
| Passat 2.0 16V 110 kW          | 92 → 97       |   | Ch.31N255990→3AV300000  | 101 024   | 100 002   |
| Passat 2.0 88 kW               | 04/00 → 11/00 |   |   | 100 091   | 102 011   |
| Passat 2.0 85 kW               | 11/00 → 05    |   |   | 100 090   | 102 011   |
| Passat 2.0 20V 96 kW           | 11/01 → 05    |   |   | 100 090   | 102 011   |
| Passat 2.0 TDI                 | 12/03 → 05    |   |   | 100 098   | 102 011   |
| Passat 2.3 VR5                 | 96 → 05       |   | Man.GBX   | 100 091   | 102 011   |
| Passat 2.3 VR5                 | 96 → 05       |   | Aut.GBX   | 100 098   | 102 011   |















































## BEMERKUNGEN/REMARKS/ REMARQUES







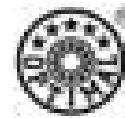

## MODELL/MODEL/MODELE

| MODELL/MODEL/MODELE              |               |   |         |         |
|----------------------------------|---------------|---|---------|---------|
| Passat 2.5 TDI                   | 98 → 05       |   | 100 098 | 102 011 |
| Passat 2.8 VR6                   | 91 → 02/92    | Ch.→31N255989                             | 100 022 | 100 002 |
| Passat 2.8 VR6                   | 02/92 → 97    | Ch.31N255990→3AV300000                    | 101 024 | 100 002 |
| Passat 2.8 V6                    | 97 → 05       | Ch.3BV000001→                             | 100 098 | 102 011 |
| Passat (3C2)                     | 03/05 → 07    |   | 101 017 | 102 019 |
| Passat Syncro                    | 85 → 88       |   | 100 014 | 100 014 |
| Passat Syncro 1.8                | 89 → 06/91    | Ch.→31M367757                             | 100 022 | 100 014 |
| Passat Syncro 1.8                | 06/91 → 97    | Ch.31M367758→3AV012704                    | 100 022 | 100 022 |
| Passat Syncro 2.0                | 89 → 06/91    | Ch.→31M367757                             | 100 022 | 100 014 |
| Passat Syncro 2.0                | 06/91 → 97    | Ch.31M367758→3AV012704                    | 100 022 | 100 022 |
| Passat Syncro 2.9 VR6            | 94 → 97       | Ch.→3AV012704                             | 101 024 | 100 022 |
| Passat Syncro / 4 Motion 1.8     | 10/96 → 00    |   | 100 091 | 100 090 |
| Passat Syncro / 4 Motion 1.9 TDI | 10/96 → 00    |   | 100 091 | 100 090 |
| Passat Syncro / 4 Motion 2.0     | 10/96 → 00    |   | 100 091 | 100 090 |
| Passat Syncro / 4 Motion 2.3 VR5 | 10/96 → 00    |   | 100 091 | 100 090 |
| Passat Syncro / 4 Motion 2.5 TDI | 10/96 → 00    |   | 100 098 | 100 090 |
| Passat Syncro / 4 Motion 2.8 V6  | 10/96 → 00    |   | 100 098 | 100 090 |
| Passat 4 Motion 1.9 TDI          | 10/00 → 05    |   | 100 098 | 100 090 |
| Passat 4 Motion 2.0              | 11/00 → 05    |   | 100 091 | 100 090 |
| Passat 4 Motion 2.3 VR5          | 11/00 → 05    |   | 100 098 | 100 090 |
| Passat 4 Motion 2.5 TDI          | 09/99 → 05    |   | 100 098 | 100 090 |
| Passat 4 Motion 2.8 V6           | 09/99 → 05    |   | 100 098 | 100 090 |
| Passat 4 Motion (3C2)            | 11/05 → 07    |   | 101 017 | 101 017 |
| Phaeton 3.0 V6 TDI 4 Motion      | 09/04 → 06    |   | 100 007 | 100 007 |
| Phaeton 3.2 V6                   | 04/02 → 06    |   | 100 007 | 100 007 |
| Phaeton 3.2 V6 4 Motion          | 02/04 → 06    |   | 100 007 | 100 007 |
| Phaeton 4.2 V8 4 Motion          | 05/03 → 06    |   | 100 007 | 100 007 |
| Phaeton 5.0 V10 TDI 4 Motion     | 11/02 → 06    |   | 100 007 | 100 007 |
| Phaeton 6.0 W12 4 Motion         | 04/02 → 06    |   | 100 007 | 100 007 |
| Polo                             | 75 → 07/94    |   | 101 044 | 100 002 |
| Polo                             | 08/94 → 10/99 | Ch.→6NXY379991                            | 101 016 | 100 002 |
| Polo                             | 10/99 → 10/01 | Ch.6NXY379992→6N201000                    | 101 016 | 102 075 |
| Polo 1.2                         | 10/01 → 05    | ABS                                       | 101 025 | 102 015 |
| Polo 1.2                         | 10/01 → 05    | ABS - Active Sensor Bearing               | 101 025 | 102 077 |
| Polo 1.2                         | 10/01 → 05    | ABS                                       | 101 027 | 102 015 |
| Polo 1.2                         | 10/01 → 05    | ABS - Active Sensor Bearing               | 101 027 | 102 077 |
| Polo 1.4 16V, 1.4 FSI            | 10/01 → 05    | Ch.9N2000001→ ABS                         | 101 027 | 102 015 |
| Polo 1.4 16V, 1.4 FSI            | 10/01 → 06    | Ch.9N2000001→ ABS - Active Sensor Bearing | 101 027 | 102 077 |
| Polo 1.4 TDI                     | 10/01 → 05    | Ch.9N2000001→ ABS                         | 101 027 | 102 015 |
| Polo 1.4 TDI                     | 10/01 → 06    | Ch.9N2000001→ ABS - Active Sensor Bearing | 101 027 | 102 077 |
| Polo 1.9 SDI, 1.9 TDI            | 10/01 → 05    | Ch.9N2000001→ ABS                         | 101 027 | 102 015 |
| Polo 1.9 SDI, 1.9 TDI            | 10/01 → 06    | Ch.9N2000001→ ABS - Active Sensor Bearing | 101 027 | 102 077 |
| Polo Classic                     | 96 → 08/99    | Ch.→6KX610000                             | 100 022 | 100 002 |
| Polo Classic                     | 08/99 → 02    | Ch.6KX610001→                             | 100 022 | 102 075 |
| Polo Variant                     | 97 → 08/99    | Ch.→6KX610000                             | 100 022 | 100 002 |
| Polo Variant                     | 08/99 → 02    | Ch.6KX610001→                             | 100 022 | 102 075 |
| Santana                          | 82 → 85       |   | 100 014 | 100 002 |
| Santana                          | 95 → 97       | Ch.→3AV300000                             | 100 022 | 100 002 |
| Santana                          | 97 → 03       | Ch.3BV000001→                             | 100 090 | 102 011 |
| Scirocco                         | 74 → 92       |   | 101 010 | 100 002 |
| Sharan                           | 96 → 00       |   | -       | 04-P201 |
| Sharan                           | 96 → 00       |   | 04-P201 | -       |
| Sharan                           | 95 → 05       |   | 131 129 | 132 131 |
| Sharan Syncro                    | 96 → 00       |   | 131 129 | 131 129 |



| MODELL/MODEL/MODELE                   |  | BEMERKUNGEN/REMARKS/<br>REMARQUES  |  |  |
|---------------------------------------|---|--|---|---|
| Sharan 4 Motion                       | 00 → 05   |  | 131 129   | 131 129   |
| Touareg 2.5 R5 TDi                    | 03 → 11/06  | ABS - Active Sensor Bearing  | 100 013   | 100 013   |
| Touareg 3.0 V6 TDi                    | 04 → 11/06  | ABS - Active Sensor Bearing Ch.→7L4035000  | 100 003   | 100 003   |
| Touareg 3.2 V6                        | 02 → 11/06  | ABS - Active Sensor Bearing Ch.→7L4035000  | 100 003   | 100 003   |
| Touareg 3.6 V6                        | 03/06 → 11/06   | ABS - Active Sensor Bearing Ch.→7L4035000  | 100 003   | 100 003   |
| Touareg 4.2 V8                        | 02 → 11/06  | ABS - Active Sensor Bearing Ch.→7L4035000  | 100 013   | 100 003   |
| Touareg 5.0 V10 TDi                   | 02 → 11/06  | ABS - Active Sensor Bearing Ch.→7L4035000  | 100 013   | 100 003   |
| Touareg 6.0 W12                       | 05 → 11/06  | ABS - Active Sensor Bearing Ch.→7L4035000  | 100 013   | 100 003   |
| Touran                                | 02/03 → 05  |  | 101 017   | 102 019   |
| Vento 1.4, 1.6, 1.8                   | 92 → 98   |  | 100 022   | 100 002   |
| Vento 1.9 D, 1.9 TD, 1.9 TDI, 1.9 SDI | 92 → 98   |  | 100 022   | 100 002   |
| Vento 2.0                             | 92 → 98   |  | 100 022   | 100 002   |
| Vento 2.0 16V                         | 92 → 98   |  | 101 024   | 100 002   |
| Vento 2.8 VR6                         | 92 → 98   |  | 101 024   | 100 002   |
| LT 28                                 | 76 → 83   |  Ch.→28DD-007273  | 101 064   | 102 054   |
| LT 28                                 | 83 → 03/86  |  Ch.28DD-007274→28G-015891  | 101 064   | 102 152   |
| LT 28                                 | 04/86 → 07/91   |  Ch.28G-015892→21N-006785   | 101 064   | 102 154   |
| LT 28                                 | 08/91 → 06/96   |  Ch.21N-006786→   | 101 064   | 102 156   |
| LT 28 II                              | 04/96 → 04  |   | 401 137   | 402 117   |
| LT 31                                 | 76 → 83   |  Ch.→28DD-007273  | 101 064   | 102 054   |
| LT 31                                 | 83 → 03/86  |  Ch.28DD-007274→28G-015891  | 101 064   | 102 152   |
| LT 31                                 | 04/86 → 07/91   |  Ch.28G-015892→21N-006785   | 101 064   | 102 154   |
| LT 31                                 | 08/91 → 96  |  Ch.21N-006786→  | 101 064   | 102 156   |
| LT 35                                 | 04/86 → 07/91   |   Ch.28G-015892→21N-006785 | 101 064   | 102 154   |
| LT 35                                 | 08/91 → 06/96   |   Ch.→21N-006786           | 101 064   | 102 156   |
| LT 35                                 | 76 → 06/96  |                            | 101 064   | 102 060   |
| LT 35 II                              | 04/96 → 04  |   | 401 137   | 402 117   |
| LT 40                                 | 83 → 96   |  3500 kg  | 101 110   | 102 060   |
| LT 40                                 | 83 → 96   |  4000 kg  | 101 110   | 102 150   |
| LT 45                                 | 83 → 96   |   | 101 110   | 102 150   |
| LT 46                                 | 96 → 04   |                            | 401 137   | 402 119   |
| LT 50                                 | 84 → 96   |   | 101 110   | 102 150   |
| LT 55                                 | 84 → 96   |   | 101 110   | 102 150   |
| Taro 1.8 4x2                          | 89 → 97   |   | 191 272   | 192 274   |
| Taro 2.2 4x4                          | 89 → 97   |   | 190 256   | 192 274   |
| Taro 2.4 4x4                          | 89 → 97   |   | 191 258   | 192 274   |
| Taro 2.4 Diesel 4x2                   | 89 → 97   |   | 191 272   | 192 274   |
| Taro 2.4 Diesel 4x4                   | 89 → 97   |   | 190 256   | 192 274   |
| Transporter / Minibus                 | T2 71 → 79  |   | 101 145   | 102 094   |
| Transporter / Minibus                 | T3 80 → 84  |  Ch.→24E023827  | 101 102   | 102 094   |
| Transporter / Minibus                 | T3 84 → 90  |  Ch.24E023828→  | 101 108   | 102 094   |
| Transporter / Minibus Syncro 4x4      | T3 84 → 90  |   | 101 105   | 102 094   |
| Transporter / Minibus                 | T4 91 → 96  |  800 - 1200 kg Ch.→70T199000  | 101 128   | 100 206   |
| Transporter / Minibus                 | T4 91 → 96  |  2000 kg Ch.→70T199000  | 101 128   | 102 207   |
| Transporter / Minibus                 | T4 96 → 03  |  800 - 1200 kg Ch. 70T200001→   | 101 209   | 100 206   |
| Transporter / Minibus                 | T4 96 → 03  |  2000 kg Ch. 70T200001→   | 101 209   | 102 207   |
| Transporter / Minibus Syncro 4x4      | T4 91 → 96  |  800 - 1200 kg Ch.→70T199000  | 101 128   | 100 206   |
| Transporter / Minibus Syncro 4x4      | T4 91 → 96  |  2000 kg Ch.→70T199000  | 101 128   | 102 207   |
| Transporter / Minibus Syncro 4x4      | T4 96 → 03  |  800 - 1200 kg Ch. 70T200001→   | 101 209   | 100 206   |
| Transporter / Minibus Syncro 4x4      | T4 96 → 03  |  2000 kg Ch. 70T200001→   | 101 209   | 102 207   |
| Transporter / Multivan                | T5 03 → 05  |   | 100 013   | 100 013   |
| Transporter / Multivan 4 Motion       | T5 04 → 05  |   | 100 013   | 100 013   |



| MODELL/MODEL/MODELE      |               | BEMERKUNGEN/REMARKS/<br>REMARQUES |         |         |
|--------------------------|---------------|-----------------------------------|---------|---------|
| 66                       | 75 → 80       |                                   | 891 822 | -       |
| 240                      | 81 → 93       |                                   | 891 522 | 892 460 |
| 260                      | 81 → 85       |                                   | 891 522 | 892 460 |
| 340                      | 83 → 85       | Ch.→120999                        | 891 822 | -       |
| 340                      | 86 → 92       | Ch.121000→                        | 891 822 | 892 474 |
| 343, 345                 | 80 → 82       | Mot.B14                           | 891 822 | -       |
| 343, 345                 | 81 → 82       | Mot.B19                           | 891 822 | -       |
| 360                      | 83 → 85       | Ch.→120999                        | 891 822 | -       |
| 360                      | 86 → 92       | Ch.121000→                        | 891 822 | 892 474 |
| 440                      | 88 → 06/91    | <del>ABS</del> Ch.→205699         | 891 484 | 892 470 |
| 440                      | 89 → 06/91    | ABS Ch.→205699                    | 891 484 | 892 472 |
| 440                      | 07/91 → 96    | <del>ABS</del> Ch. 205700→        | 891 486 | 892 470 |
| 440                      | 07/91 → 96    | ABS Ch. 205700→                   | 891 486 | 892 472 |
| 460                      | 90 → 06/91    | <del>ABS</del> Ch.→205699         | 891 484 | 892 470 |
| 460                      | 90 → 06/91    | ABS Ch.→205699                    | 891 484 | 892 472 |
| 460                      | 07/91 → 96    | <del>ABS</del> Ch. 205700→        | 891 486 | 892 470 |
| 460                      | 07/91 → 96    | ABS Ch. 205700→                   | 891 486 | 892 472 |
| 480                      | 86 → 06/91    | <del>ABS</del> Ch.→567102         | 891 484 | 892 470 |
| 480                      | 89 → 06/91    | ABS Ch.→567102                    | 891 484 | 892 472 |
| 480                      | 07/91 → 95    | <del>ABS</del> Ch.567103→         | 891 486 | 892 470 |
| 480                      | 07/91 → 95    | ABS Ch.567103→                    | 891 486 | 892 472 |
| 740                      | 83 → 06/85    |                                   | 891 520 | 892 458 |
| 740                      | 07/85 → 06/87 | <del>E.T.C.</del>                 | 891 520 | 892 458 |
| 740                      | 07/85 → 06/87 | E.T.C                             | 891 520 | 892 460 |
| 740                      | 07/87 → 06/88 | <del>E.T.C.</del> ABS             | 891 482 | 892 458 |
| 740                      | 07/87 → 06/88 | E.T.C ABS                         | 891 536 | 892 460 |
| 740                      | 07/88 → 92    | <del>ABS</del>                    | 891 482 | 892 458 |
| 740                      | 07/88 → 92    | ABS                               | 891 466 | 892 458 |
| 740 2.0 DACT 16V Turbo   | 90 → 92       | Multi-Link                        | 891 466 | 892 468 |
| 760                      | 81 → 06/85    |                                   | 891 520 | 892 458 |
| 760                      | 07/85 → 06/87 | <del>E.T.C.</del>                 | 891 520 | 892 458 |
| 760                      | 07/85 → 06/87 | E.T.C                             | 891 520 | 892 460 |
| 760                      | 07/87 → 90    | <del>ABS</del>                    | 891 482 | 892 468 |
| 760                      | 07/87 → 90    | <del>ABS</del>                    | 891 482 | 892 458 |
| 760                      | 07/87 → 06/88 | ABS                               | 891 536 | 892 468 |
| 760                      | 07/87 → 06/88 | ABS                               | 891 536 | 892 458 |
| 760                      | 07/88 → 90    | ABS                               | 891 466 | 892 468 |
| 760                      | 07/88 → 90    | ABS                               | 891 466 | 892 458 |
| 780                      | 85 → 07/87    |                                   | 891 520 | 892 458 |
| 780                      | 08/87 → 07/88 |                                   | 891 536 | 892 458 |
| 780                      | 08/88 → 07/89 |                                   | 891 466 | 892 458 |
| 780                      | 08/89 → 90    | Multi-Link                        | 891 466 | 892 468 |
| 850                      | 91 → 06/93    |                                   | 891 544 | 892 733 |
| 850                      | 07/93 → 12/95 | Ch.→219645                        | 891 628 | 892 735 |
| 850                      | 01/95 → 97    | Ch.219646→                        | 891 628 | 892 735 |
| 850                      | 07/93 → 12/95 | Ch.→121428                        | 891 628 | 892 735 |
| 850                      | 01/95 → 97    | Ch.121429→                        | 891 628 | 892 735 |
| 850 AWD                  | 96 → 97       |                                   | 891 628 | 892 468 |
| 940 2.0 Turbo            | 90 → 98       |                                   | 891 466 | 892 468 |
| 940 2.3 Turbo            | 90 → 98       |                                   | 891 466 | 892 468 |
| 940 2.0, 2.3, 2.4 Diesel | 90 → 98       | <del>ABS</del>                    | 891 482 | 892 458 |
| 940 2.0, 2.3, 2.4 Diesel | 90 → 98       | <del>ABS</del> Multi-Link         | 891 482 | 892 468 |
| 940 2.0, 2.3, 2.4 Diesel | 90 → 98       | ABS                               | 891 466 | 892 458 |
| 940 2.0, 2.3, 2.4 Diesel | 90 → 98       | ABS  Multi-Link                   | 891 466 | 892 468 |

| MODELL/MODEL/MODELE |  | BEMERKUNGEN/REMARKS/<br>REMARQUES  |  |  |
|---------------------|---|--|---|---|
| 960                 | 91 → 07/94  | ABS             | 891 482   | 892 458   |
| 960                 | 91 → 07/94  | ABS  Multi-Link | 891 482   | 892 468   |
| 960                 | 91 → 07/94  | ABS             | 891 466   | 892 458   |
| 960                 | 91 → 07/94  | ABS  Multi-Link | 891 466   | 892 468   |
| 960                 | 08/94 → 97  |  | 891 333   | 892 468   |
| S 40                | 95 → 06/97  |  | 891 731   | 892 843   |
| S 40                | 07/97 → 12/03   |  | 891 477   | 892 843   |
| S 40 II             | 01/04 → 12/06   |  | 301 667   | -   |
| S 40 II AWD         | 01/04 → 12/06   |  | 301 667   | -   |
| V 40                | 95 → 06/97  |  | 891 731   | 892 843   |
| V 40                | 07/97 → 04  |  | 891 477   | 892 843   |
| V 50                | 04/04 → 12/06   |  | 301 667   | -   |
| S 60                | 00 → 04   |  | 891 878   | 892 872   |
| S 60 AWD            | 01 → 04   |  | 891 878   | 892 929   |
| C 70                | 97 → 06/98  |  | 891 469   | 892 735   |
| C 70                | 07/98 → 04  |  | 891 869   | 892 735   |
| C 70 cabriolet      | 03/06 → 12/06   |  | 301 667   | -   |
| S 70                | 97 → 06/98  |  | 891 469   | 892 735   |
| S 70                | 07/98 → 00  |  | 891 869   | 892 735   |
| V 70                | 97 → 06/98  |  | 891 469   | 892 735   |
| V 70                | 07/98 → 03/00   |  | 891 869   | 892 735   |
| V 70                | 04/00 → 04  |  | 891 878   | 892 872   |
| V 70 AWD            | 97 → 06/98  |  | 891 469   | 892 468   |
| V 70 AWD            | 07/98 → 03/00   |  | 891 869   | 892 468   |
| V 70 AWD            | 04/00 → 04  |  | 891 878   | 892 929   |
| XC 70 AWD           | 00 → 04   |  | 891 878   | 892 929   |
| S 80                | 98 → 04   |  | 891 878   | 892 872   |
| S 80 AWD            | 03 → 04   |  | 891 878   | 892 929   |
| S 90                | 97 → 98   |  | 891 333   | 892 468   |
| V 90                | 97 → 98   |  | 891 333   | 892 468   |
| XC 90               | 10/02 → 04/06   |  | 891 591   | 892 589   |
| XC 90 AWD           | 10/02 → 04/06   |  | 891 591   | 892 587   |



| MODELL/MODEL/MODELE |  | BEMERKUNGEN/REMARKS/<br>REMARQUES |  |  |
|---------------------|---|-----------------------------------|---|---|
| 750, 850            | 78 → 81   |                                   | 801 538   | 802 464   |
| 750, 850            | 82 → 86   |                                   | 801 538   | -   |
| Yugo 45, Yugo 55    | 81 → 90   |                                   | 800 408   | 802 318   |
| Yugo 101            | 78 → 06/82  |                                   | 800 408   | 802 318   |
| Yugo 101            | 07/82 → 90  |                                   | 800 304   | 802 318   |

**100 002**

|            |  |        |       |    |   |
|------------|--|--------|-------|----|---|
| AUDI       | 50                                       | 74     | 78    | ✓  |   |
| AUDI       | 80                                       | 74     | 04/88 | ✓  |   |
| AUDI       | 80 1.6, 1.8, 1.9, 2.0                    | 05/88  | 92    | ✓  |   |
| AUDI       | 90                                       | 85     | 04/88 | ✓  |   |
| AUDI       | 90 1.6, 1.8, 2.0                         | 05/88  | 91    | ✓  |   |
| AUDI       | 100                                      | 75     | 76    | ✓  |   |
| AUDI       | Coupé 1.8, 2.0, 2.23                     | 81     | 88    | ✓  |   |
| AUDI       | Coupé 2.3 V5 10V                         | 81     | 88    | ✓  |   |
| PORSCHE    | 924                                      | 76     | 85    | ✓  |   |
| SEAT       | Arosa                                    | 97     | 99    | ✓  |   |
| SEAT       | Cordoba                                  | 93     | 99    | ✓  |   |
| SEAT       | Ibiza II                                 | 93     | 08/99 | ✓  |   |
| SEAT       | Toledo I 1.6i                            | 91     | 03/99 | ✓  |   |
| SEAT       | Toledo I 1.8i                            | 91     | 96    | ✓  |   |
| SEAT       | Toledo I 1.8 16V                         | 91     | 03/99 | ✓  |   |
| SEAT       | Toledo I 1.9 D, 1.9 TD                   | 91     | 03/99 | ✓  |   |
| SEAT       | Toledo I 1.9 SDI, 1.9 TDI                | 95     | 03/99 | ✓  |   |
| SEAT       | Toledo I 2.0i                            | 91     | 96    | ✓  |   |
| SEAT       | Toledo I 2.0 16V                         | 95     | 03/99 | ✓  |   |
| SKODA      | Favorit 115, 135, 136                    | 01/93  | 94    | ✓  |   |
| SKODA      | Felicia                                  | 94     | 01    | ✓  |   |
| SKODA      | Forman                                   | 93     | 01    | ✓  |   |
| SKODA      | Pick-up                                  | 95     | 02    | ✓  |   |
| VOLKSWAGEN | Caddy II Pick-up                         | 97     | 01    | ✓  |   |
| VOLKSWAGEN | Corrado 1.8                              | 89     | 95    | ✓  |   |
| VOLKSWAGEN | Corrado 2.0, 2.9 VR6                     | 91     | 95    | ✓  |   |
| VOLKSWAGEN | Derby                                    | 77     | 90    | ✓  |   |
| VOLKSWAGEN | Golf I                                   | 74     | 84    | ✓  |   |
| VOLKSWAGEN | Golf II                                  | 84     | 91    | ✓  |   |
| VOLKSWAGEN | Golf III 1.4, 1.6, 1.8, 1.9, 2.0         | 92     | 98    | ✓  |   |
| VOLKSWAGEN | Golf III 1.9 D, 1.9 TD, 1.9 TDI, 1.9 SDI | 92     | 98    | ✓  |   |
| VOLKSWAGEN | Golf III 1.9 GTI, 2.0 GTI, 2.8 VR6       | 92     | 98    | ✓  |   |
| VOLKSWAGEN | Golf III Variant                         | 92     | 98    | ✓  |   |
| VOLKSWAGEN | Golf Cabriolet                           | 79     | 04    | ✓  |   |
| VOLKSWAGEN | Jetta                                    | 79     | 92    | ✓  |   |
| VOLKSWAGEN | Passat                                   | 74     | 03/88 | ✓  |   |
| VOLKSWAGEN | Passat 1.6, 1.8                          | 04/88  | 97    | ✓  |   |
| VOLKSWAGEN | Passat 1.9 D                             | 04/88  | 10/93 | ✓  |   |
| VOLKSWAGEN | Passat 1.9 TD                            | 03/91  | 96    | ✓  |   |
| VOLKSWAGEN | Passat 1.9 TDI                           | 66 kW  | 10/93 | 97 | ✓ |
| VOLKSWAGEN | Passat 1.9 TDI                           | 81 kW  | 92    | 97 | ✓ |
| VOLKSWAGEN | Passat 2.0                               | 79 kW  | 90    | 96 | ✓ |
| VOLKSWAGEN | Passat 2.0                               | 85 kW  | 90    | 97 | ✓ |
| VOLKSWAGEN | Passat 2.0 16V                           | 110 kW | 92    | 97 | ✓ |
| VOLKSWAGEN | Passat 2.8 VR6                           | 91     | 97    | ✓  |   |
| VOLKSWAGEN | Polo                                     | 75     | 10/99 | ✓  |   |
| VOLKSWAGEN | Polo Classic                             | 96     | 08/99 | ✓  |   |
| VOLKSWAGEN | Polo Variant                             | 97     | 08/99 | ✓  |   |
| VOLKSWAGEN | Santana                                  | 82     | 85    | ✓  |   |
| VOLKSWAGEN | Santana                                  | 95     | 97    | ✓  |   |
| VOLKSWAGEN | Scirocco                                 | 74     | 92    | ✓  |   |
| VOLKSWAGEN | Vento 1.4, 1.6, 1.8, 2.0, 2.0 16V        | 92     | 98    | ✓  |   |
| VOLKSWAGEN | Vento 1.9 D, 1.9 TD, 1.9 TDI, 1.9 SDI    | 92     | 98    | ✓  |   |
| VOLKSWAGEN | Vento 2.8 VR6                            | 92     | 98    | ✓  |   |

**100 003**

|            |                             |       |       |   |   |
|------------|-----------------------------|-------|-------|---|---|
| PORSCHE    | Cayenne                     | 02    | 05    | ✓ | ✓ |
| VOLKSWAGEN | Touareg 3.0 V6 TDi          | 04    | 11/06 | ✓ | ✓ |
| VOLKSWAGEN | Touareg 3.2 V6              | 02    | 11/06 | ✓ | ✓ |
| VOLKSWAGEN | Touareg 3.6 V6              | 03/06 | 11/06 | ✓ | ✓ |
| VOLKSWAGEN | Touareg 4.2 V8, 5.0 V10 TDi | 02    | 11/06 | ✓ |   |
| VOLKSWAGEN | Touareg 6.0 W12             | 05    | 11/06 | ✓ |   |

**100 007**

|            |                             |       |    |   |   |
|------------|-----------------------------|-------|----|---|---|
| VOLKSWAGEN | Phaeton 3.0 V6 TDi 4 Motion | 09/04 | 06 | ✓ | ✓ |
| VOLKSWAGEN | Phaeton 3.2 V6              | 04/02 | 06 | ✓ | ✓ |
| VOLKSWAGEN | Phaeton 3.2 V6 4 Motion     | 02/04 | 06 | ✓ | ✓ |
| VOLKSWAGEN | Phaeton 4.2 V8 4 Motion     | 05/03 | 06 | ✓ | ✓ |

**100 007**

|            |                              |       |    |   |   |
|------------|------------------------------|-------|----|---|---|
| VOLKSWAGEN | Phaeton 5.0 V10 TDi 4 Motion | 11/02 | 06 | ✓ | ✓ |
| VOLKSWAGEN | Phaeton 6.0 W12 4 Motion     | 04/02 | 06 | ✓ | ✓ |

**100 013**

|            |                                 |    |       |    |   |   |
|------------|---------------------------------|----|-------|----|---|---|
| VOLKSWAGEN | Touareg 2.5 R5 TDi              | 03 | 11/06 | ✓  | ✓ |   |
| VOLKSWAGEN | Touareg 4.2 V8, 5.0 V10 TDi     | 02 | 11/06 | ✓  |   |   |
| VOLKSWAGEN | Touareg 6.0 W12                 | 05 | 11/06 | ✓  |   |   |
| VOLKSWAGEN | Transporter / Multivan          | T5 | 03    | 05 | ✓ | ✓ |
| VOLKSWAGEN | Transporter / Multivan 4 Motion | T5 | 04    | 05 | ✓ | ✓ |

**100 014**



|            |                                   |    |       |   |   |
|------------|-----------------------------------|----|-------|---|---|
| AUDI       | 80                                | 74 | 04/88 | ✓ |   |
| AUDI       | 80 Quattro                        | 83 | 05/88 | ✓ |   |
| AUDI       | 90                                | 85 | 04/88 | ✓ |   |
| AUDI       | 90 Quattro                        | 85 | 05/88 | ✓ |   |
| AUDI       | Coupé 1.8, 2.0, 2.23, 2.3 V5 10V  | 81 | 88    | ✓ |   |
| AUDI       | Coupé Quattro                     | 85 | 88    | ✓ |   |
| VOLKSWAGEN | Golf II Syncro                    | 86 | 91    |   | ✓ |
| VOLKSWAGEN | Golf III Syncro 1.8, 1.9 TDI, 2.0 | 93 | 98    |   | ✓ |
| VOLKSWAGEN | Jetta Syncro                      | 88 | 91    |   | ✓ |
| VOLKSWAGEN | Passat                            | 74 | 03/88 | ✓ |   |
| VOLKSWAGEN | Passat Syncro                     | 85 | 88    | ✓ | ✓ |
| VOLKSWAGEN | Passat Syncro 1.8, 2.0            | 89 | 06/91 |   | ✓ |
| VOLKSWAGEN | Santana                           | 82 | 85    | ✓ |   |

**100 022**

|            |  |       |       |    |   |
|------------|--|-------|-------|----|---|
| SEAT       | Cordoba                                  | 93    | 08/02 | ✓  |   |
| SEAT       | Ibiza II                                 | 93    | 08/99 | ✓  |   |
| SEAT       | Ibiza III                                | 08/99 | 02/02 | ✓  |   |
| SEAT       | Inca                                     | 95    | 04    | ✓  |   |
| SEAT       | Toledo I 1.6i                            | 91    | 03/99 | ✓  |   |
| SEAT       | Toledo I 1.8i, 2.0i                      | 91    | 96    | ✓  |   |
| SEAT       | Toledo I 1.8 16V                         | 91    | 03/99 | ✓  |   |
| SEAT       | Toledo I 1.9 D, 1.9 TD                   | 91    | 03/99 | ✓  |   |
| SEAT       | Toledo I 1.9 SDI, 1.9 TDI                | 95    | 03/99 | ✓  |   |
| VOLKSWAGEN | Caddy II                                 | 95    | 04    | ✓  |   |
| VOLKSWAGEN | Corrado 1.8                              | 89    | 95    | ✓  |   |
| VOLKSWAGEN | Corrado 2.0                              | 91    | 95    | ✓  |   |
| VOLKSWAGEN | Golf II                                  | 88    | 91    | ✓  |   |
| VOLKSWAGEN | Golf II Syncro                           | 88    | 91    | ✓  |   |
| VOLKSWAGEN | Golf III 1.4, 1.6, 1.8, 1.9, 2.0         | 92    | 98    | ✓  |   |
| VOLKSWAGEN | Golf III 1.9 D, 1.9 TD, 1.9 TDI, 1.9 SDI | 92    | 98    | ✓  |   |
| VOLKSWAGEN | Golf III Syncro 1.8, 1.9 TDI, 2.0        | 93    | 98    | ✓  |   |
| VOLKSWAGEN | Golf III Syncro 2.9 VR6                  | 93    | 98    |    | ✓ |
| VOLKSWAGEN | Golf III Variant                         | 92    | 98    | ✓  |   |
| VOLKSWAGEN | Golf Cabriolet                           | 09/93 | 04    | ✓  |   |
| VOLKSWAGEN | Jetta                                    | 88    | 92    | ✓  |   |
| VOLKSWAGEN | Jetta Syncro                             | 88    | 91    | ✓  |   |
| VOLKSWAGEN | Passat 1.6, 1.8                          | 04/88 | 97    | ✓  |   |
| VOLKSWAGEN | Passat 1.9 D                             | 04/88 | 10/93 | ✓  |   |
| VOLKSWAGEN | Passat 1.9 TD                            | 03/91 | 96    | ✓  |   |
| VOLKSWAGEN | Passat 1.9 TDI                           | 66 kW | 10/93 | 97 | ✓ |
| VOLKSWAGEN | Passat 2.0                               | 79 kW | 90    | 96 | ✓ |
| VOLKSWAGEN | Passat 2.0                               | 85 kW | 90    | 97 | ✓ |
| VOLKSWAGEN | Passat 2.8 VR6                           | 91    | 02/92 | ✓  |   |
| VOLKSWAGEN | Passat Syncro 1.8                        | 89    | 97    | ✓  |   |
| VOLKSWAGEN | Passat Syncro 1.8                        | 06/91 | 97    |    | ✓ |
| VOLKSWAGEN | Passat Syncro 2.0                        | 89    | 97    | ✓  |   |
| VOLKSWAGEN | Passat Syncro 2.0                        | 06/91 | 97    |    | ✓ |
| VOLKSWAGEN | Passat Syncro 2.9 VR6                    | 94    | 97    |    | ✓ |
| VOLKSWAGEN | Polo Classic                             | 96    | 02    | ✓  |   |
| VOLKSWAGEN | Polo Variant                             | 97    | 02    | ✓  |   |
| VOLKSWAGEN | Santana                                  | 95    | 97    | ✓  |   |
| VOLKSWAGEN | Vento 1.4, 1.6, 1.8, 2.0                 | 92    | 98    | ✓  |   |
| VOLKSWAGEN | Vento 1.9 D, 1.9 TD, 1.9 TDI, 1.9 SDI    | 92    | 98    | ✓  |   |

**100 036**

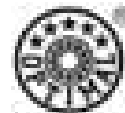
|      |            |    |       |   |  |
|------|------------|----|-------|---|--|
| AUDI | 80 Quattro | 83 | 05/88 | ✓ |  |
|------|------------|----|-------|---|--|



**100 036**



|      |                   |    |       |   |   |
|------|-------------------|----|-------|---|---|
| AUDI | 90 Quattro        | 85 | 05/88 |   | ✓ |
| AUDI | 100               | 75 | 77    | ✓ |   |
| AUDI | 100, 100 Avant    | 78 | 09/85 | ✓ |   |
| AUDI | 100 Avant Quattro | 84 | 09/85 | ✓ |   |
| AUDI | 200               | 80 | 08/85 | ✓ |   |
| AUDI | 200 Avant Quattro | 85 | 85    | ✓ |   |
| AUDI | Coupé Quattro     | 85 | 88    |   | ✓ |
| AUDI | Quattro           | 80 | 91    |   | ✓ |

**100 053**



|      |                           |            |       |       |   |   |
|------|---------------------------|------------|-------|-------|---|---|
| AUDI | A4                        | (8E2, B6)  | 00    | 10/04 | ✓ |   |
| AUDI | A4                        | (8EC)      | 11/04 | 06    | ✓ |   |
| AUDI | A4 Avant, Avant Quattro   | (8E5, B6)  | 00    | 06    | ✓ |   |
| AUDI | A4 Avant                  | (8ED)      | 00    | 10/04 | ✓ |   |
| AUDI | A4 Cabrio, Cabrio Quattro | (8H7)      | 03    | 10/04 | ✓ |   |
| AUDI | A4 Quattro                | (8E2, B6)  | 00    | 10/04 | ✓ |   |
| AUDI | A6 2.0                    | (4B, C5)   | 01    | 04/04 | ✓ |   |
| AUDI | A6 Avant 4.2 V8           | (4B, C5)   | 98    | 04/04 | ✓ | ✓ |
| AUDI | A6 Avant Quattro 4.2 V8   | (4B, C5)   | 98    | 04/04 | ✓ | ✓ |
| AUDI | A6 Quattro 3.0            | (4B, C5)   | 01    | 04/04 | ✓ |   |
| AUDI | A6 Quattro 3.7            | (4B, C5)   | 99    | 04/04 | ✓ |   |
| AUDI | A6 Quattro 4.2 V8         | (4B, C5)   | 98    | 04/04 | ✓ | ✓ |
| AUDI | A8                        | (4D2, 4D8) | 98    | 09/02 | ✓ | ✓ |
| AUDI | A8                        | (4E_)      | 10/02 | 04/04 | ✓ |   |
| AUDI | A8 Quattro                | (4D2, 4D8) | 98    | 09/02 | ✓ | ✓ |
| AUDI | A8 Quattro                | (4E_)      | 10/02 | 05/03 | ✓ | ✓ |
| AUDI | RS4 Quattro               |            | 00    | 01    | ✓ |   |
| AUDI | RS6 Quattro               |            | 02    | 04    | ✓ |   |
| AUDI | S4 Quattro                | (8E2, B6)  | 03    | 04    | ✓ |   |
| AUDI | S4 Avant Quattro          |            | 99    | 09/01 | ✓ |   |
| AUDI | S6 Quattro                |            | 99    | 04    | ✓ | ✓ |
| AUDI | S8 Quattro                |            | 01/99 | 02    | ✓ | ✓ |

**100 056**



|      |                                    |       |       |   |   |
|------|------------------------------------|-------|-------|---|---|
| AUDI | 100, 100 Avant                     | 84    | 87    | ✓ |   |
| AUDI | 100 Automatic, 100 Avant Automatic | 88    | 90    | ✓ |   |
| AUDI | 100 Avant Quattro                  | 84    | 87    |   | ✓ |
| AUDI | 100 Avant Quattro                  | 09/85 | 87    | ✓ |   |
| AUDI | 200                                | 09/85 | 91    | ✓ |   |
| AUDI | 200 Avant Quattro                  | 85    | 85    |   | ✓ |
| AUDI | 200 Avant Quattro                  | 86    | 01/88 | ✓ | ✓ |
| AUDI | Quattro                            | 08/85 | 91    | ✓ |   |
| AUDI | Sport Quattro                      | 84    | 91    | ✓ | ✓ |

**100 090**



|      |                                  |        |       |       |   |
|------|----------------------------------|--------|-------|-------|---|
| AUDI | 80 1.6, 1.9, 2.0                 | 05/88  | 94    | ✓     |   |
| AUDI | 80 1.8, 2.2                      | 05/88  | 92    | ✓     |   |
| AUDI | 80 2.3                           | 100 kW | 91    | 94    | ✓ |
| AUDI | 80 Avant 1.6, 1.9, 2.0, 2.3      | 92     | 96    | ✓     |   |
| AUDI | 80 Quattro 1.8, 1.9, 2.0         | 05/88  | 09/91 | ✓     | ✓ |
| AUDI | 80 Quattro 2.0                   | 10/91  | 94    | ✓     |   |
| AUDI | 80 Quattro 2.3                   | 100 kW | 05/88 | 09/91 | ✓ |
| AUDI | 80 Quattro 2.3                   | 100 kW | 10/91 | 94    | ✓ |
| AUDI | 80 Quattro 2.3                   | 125 kW | 05/88 | 09/91 | ✓ |
| AUDI | 90                               | 87     | 04/88 | ✓     |   |
| AUDI | 90 1.6, 1.8, 2.0                 | 05/88  | 91    | ✓     |   |
| AUDI | 90 2.3                           | 100 kW | 88    | 91    | ✓ |
| AUDI | 90 Quattro                       | 04/87  | 05/88 | ✓     |   |
| AUDI | 90 Quattro 2.0                   | 05/88  | 91    | ✓     | ✓ |
| AUDI | 90 Quattro 2.3                   | 100 kW | 05/88 | 91    | ✓ |
| AUDI | 90 Quattro 2.3 20V               | 125 kW | 88    | 91    | ✓ |
| AUDI | Cabriolet 1.8, 1.9 TDI, 2.0, 2.3 | 91     | 00    | ✓     |   |
| AUDI | Coupé 1.8, 2.0, 2.23             | 89     | 96    | ✓     |   |
| AUDI | Coupé 2.3 V5 10V                 | 89     | 96    | ✓     |   |
| AUDI | Coupé Quattro 2.0                | 89     | 91    | ✓     | ✓ |
| AUDI | Coupé Quattro 2.2                | 89     | 96    |       | ✓ |
| AUDI | Coupé Quattro 2.23               | 89     | 91    | ✓     | ✓ |
| AUDI | Coupé Quattro 2.3 V5 10V         | 89     | 94    | ✓     | ✓ |

**100 090**



|            |                                  |       |       |       |   |
|------------|----------------------------------|-------|-------|-------|---|
| AUDI       | Coupé Quattro 2.3 V5 20V         | 89    | 96    |       | ✓ |
| AUDI       | Coupé Quattro 2.6 V6, 2.6 V6     | 89    | 96    |       | ✓ |
| VOLKSWAGEN | Passat 1.9 TDI                   | 85 kW | 98    | 11/00 | ✓ |
| VOLKSWAGEN | Passat 2.0                       | 85 kW | 11/00 | 05    | ✓ |
| VOLKSWAGEN | Passat 2.0 20V                   | 96 kW | 11/01 | 05    | ✓ |
| VOLKSWAGEN | Passat Syncro / 4 Motion 1.8     |       | 10/96 | 00    | ✓ |
| VOLKSWAGEN | Passat Syncro / 4 Motion 1.9 TDI |       | 10/96 | 00    | ✓ |
| VOLKSWAGEN | Passat Syncro / 4 Motion 2.0     |       | 10/96 | 00    | ✓ |
| VOLKSWAGEN | Passat Syncro / 4 Motion 2.3 VR5 |       | 10/96 | 00    | ✓ |
| VOLKSWAGEN | Passat Syncro / 4 Motion 2.5 TDI |       | 10/96 | 00    | ✓ |
| VOLKSWAGEN | Passat Syncro / 4 Motion 2.8 V6  |       | 10/96 | 00    | ✓ |
| VOLKSWAGEN | Passat 4 Motion 1.9 TDI          |       | 10/00 | 05    | ✓ |
| VOLKSWAGEN | Passat 4 Motion 2.0              |       | 11/00 | 05    | ✓ |
| VOLKSWAGEN | Passat 4 Motion 2.3 VR5          |       | 11/00 | 05    | ✓ |
| VOLKSWAGEN | Passat 4 Motion 2.5 TDI          |       | 09/99 | 05    | ✓ |
| VOLKSWAGEN | Passat 4 Motion 2.8 V6           |       | 09/99 | 05    | ✓ |
| VOLKSWAGEN | Santana                          |       | 97    | 03    | ✓ |

**100 091**



|            |                                       |           |       |       |   |   |
|------------|---------------------------------------|-----------|-------|-------|---|---|
| AUDI       | A4 1.6, 1.8, 1.8T, 1.9 TDI            | (8D2, B5) | 95    | 00    | ✓ |   |
| AUDI       | A4 Avant 1.6, 1.8, 1.8 T              | (8D5, B5) | 95    | 01    | ✓ |   |
| AUDI       | A4 Avant 1.9 TDI                      | (8D5, B5) | 95    | 01    | ✓ |   |
| AUDI       | A4 Avant Quattro 1.8, 1.9 TDI         | (8D5, B5) | 95    | 01    | ✓ |   |
| AUDI       | A4 Quattro 1.8, 1.9 TDI               | (8D2, B5) | 95    | 00    | ✓ |   |
| AUDI       | A6 1.8                                | (4B, C5)  | 98    | 04/04 | ✓ |   |
| AUDI       | A6 1.8 T 110 kW                       | (4B, C5)  | 97    | 04/04 | ✓ |   |
| AUDI       | A6 Avant 1.8 T 110 kW                 | (4B, C5)  | 97    | 04/04 | ✓ |   |
| AUDI       | A6 Avant Quattro 1.8T 110 kW          | (4B, C5)  | 97    | 04/04 | ✓ |   |
| AUDI       | A6 Quattro 1.8T 110 kW                | (4B, C5)  | 97    | 04/04 | ✓ |   |
| AUDI       | RS4 Quattro                           |           | 00    | 01    |   | ✓ |
| SKODA      | Superb 1.8 Turbo 20V                  |           | 02/02 | 06    | ✓ |   |
| SKODA      | Superb 1.9 TDI                        | 74 kW     | 02/02 | 06    | ✓ |   |
| SKODA      | Superb 2.0                            |           | 02/02 | 06    | ✓ |   |
| VOLKSWAGEN | Passat 1.6, 1.8                       |           | 97    | 04    | ✓ |   |
| VOLKSWAGEN | Passat 1.9 TDI                        | 66 kW     | 97    | 00    | ✓ |   |
| VOLKSWAGEN | Passat 2.0                            | 88 kW     | 04/00 | 11/00 | ✓ |   |
| VOLKSWAGEN | Passat 2.3 VR5                        |           | 96    | 05    | ✓ |   |
| VOLKSWAGEN | Passat Syncro / 4 Motion 1.8, 1.9 TDI |           | 10/96 | 00    | ✓ |   |
| VOLKSWAGEN | Passat Syncro / 4 Motion 2.0, 2.3 VR5 |           | 10/96 | 00    | ✓ |   |
| VOLKSWAGEN | Passat 4 Motion 2.0                   |           | 11/00 | 05    | ✓ |   |

**100 093**



|      |                             |           |       |       |  |   |
|------|-----------------------------|-----------|-------|-------|--|---|
| AUDI | 80 Quattro 2.0              |           | 10/91 | 94    |  | ✓ |
| AUDI | 80 Quattro 2.3              | 100 kW    | 10/91 | 94    |  | ✓ |
| AUDI | 80 Quattro 2.3              | 125 kW    | 10/91 | 94    |  | ✓ |
| AUDI | 80 Quattro 2.6 V6, 2.8 V6   |           | 91    | 94    |  | ✓ |
| AUDI | A4 Avant Quattro 1.8        | (8D5, B5) | 95    | 01    |  | ✓ |
| AUDI | A4 Avant Quattro 1.8 132 kW | (8D5, B5) | 96    | 01    |  | ✓ |
| AUDI | A4 Avant Quattro 1.9 TDI    | (8D5, B5) | 95    | 01    |  | ✓ |
| AUDI | A4 Avant Quattro 2.4        | (8D5, B5) | 96    | 01    |  | ✓ |
| AUDI | A4 Avant Quattro 2.5 TDI    | (8D5, B5) | 96    | 01    |  | ✓ |
| AUDI | A4 Avant Quattro 2.6        | (8D5, B5) | 95    | 01    |  | ✓ |
| AUDI | A4 Avant Quattro 2.7        | (8D5, B5) | 96    | 01    |  | ✓ |
| AUDI | A4 Avant Quattro 2.8 128 kW | (8D5, B5) | 95    | 01    |  | ✓ |
| AUDI | A4 Avant Quattro 2.8 142 kW | (8D5, B5) | 96    | 01    |  | ✓ |
| AUDI | A4 Quattro 1.8, 1.9 TDI     | (8D2, B5) | 95    | 00    |  | ✓ |
| AUDI | A4 Quattro 1.8 132 kW       | (8D2, B5) | 96    | 00    |  | ✓ |
| AUDI | A4 Quattro 2.4, 2.5 TDI     | (8D2, B5) | 96    | 00    |  | ✓ |
| AUDI | A4 Quattro 2.6              | (8D2, B5) | 95    | 00    |  | ✓ |
| AUDI | A4 Quattro 2.7              | (8D2, B5) | 96    | 00    |  | ✓ |
| AUDI | A4 Quattro 2.8 128 kW       | (8D2, B5) | 95    | 00    |  | ✓ |
| AUDI | A4 Quattro 2.8 142 kW       | (8D2, B5) | 96    | 00    |  | ✓ |
| AUDI | S4 Quattro                  | (8D2, B5) | 97    | 01    |  | ✓ |
| AUDI | S4 Avant Quattro            |           | 97    | 09/01 |  | ✓ |

**100 098**



|      |                   |  |       |    |  |   |
|------|-------------------|--|-------|----|--|---|
| AUDI | 80 Avant Quattro  |  | 92    | 95 |  | ✓ |
| AUDI | 200 Avant Quattro |  | 02/88 | 91 |  | ✓ |



**100 098**

|            |                                      |           |       |       |   |   |
|------------|--------------------------------------|-----------|-------|-------|---|---|
| AUDI       | A4 1.8 T 132kW                       | (8D2,B5)  | 97    | 00    | ✓ |   |
| AUDI       | A4 2.4, 2.5 TDI, 2.6, 2.8            | (8D2,B5)  | 96    | 00    | ✓ |   |
| AUDI       | A4 Avant 1.8 T 132kW                 | (8D5,B5)  | 97    | 01    | ✓ |   |
| AUDI       | A4 Avant 2.4, 2.5 TDI                | (8D5,B5)  | 96    | 01    | ✓ |   |
| AUDI       | A4 Avant 2.6, 2.8                    | (8D5,B5)  | 96    | 01    | ✓ |   |
| AUDI       | A4 Avant Quattro 1.8 132 kW          | (8D5,B5)  | 96    | 01    | ✓ |   |
| AUDI       | A4 Avant Quattro 2.4, 2.6, 2.7       | (8D5,B5)  | 96    | 01    | ✓ |   |
| AUDI       | A4 Avant Quattro 2.5 TDI             | (8D5,B5)  | 96    | 01    | ✓ |   |
| AUDI       | A4 Avant Quattro 2.8 128 kW          | (8D5,B5)  | 96    | 01    | ✓ |   |
| AUDI       | A4 Avant Quattro 2.8 142 kW          | (8D5,B5)  | 96    | 01    | ✓ |   |
| AUDI       | A4 Quattro 1.8 132 kW                | (8D2,B5)  | 96    | 00    | ✓ |   |
| AUDI       | A4 Quattro 2.4, 2.6, 2.7             | (8D2,B5)  | 96    | 00    | ✓ |   |
| AUDI       | A4 Quattro 2.5 TDI                   | (8D2,B5)  | 96    | 00    | ✓ |   |
| AUDI       | A4 Quattro 2.8 128 kW                | (8D2,B5)  | 96    | 00    | ✓ |   |
| AUDI       | A4 Quattro 2.8 142 kW                | (8D2,B5)  | 96    | 00    | ✓ |   |
| AUDI       | A6                                   | (4A, C4)  | 94    | 97    | ✓ |   |
| AUDI       | A6 1.8 T 110 kW, 132 kW              | (4B, C5)  | 97    | 04/04 | ✓ |   |
| AUDI       | A6 1.9 TDI, 2.4, 2.5 TDI             | (4B, C5)  | 97    | 04/04 | ✓ |   |
| AUDI       | A6 2.7 T                             | (4B, C5)  | 99    | 04/04 | ✓ |   |
| AUDI       | A6 2.8                               | (4B, C5)  | 97    | 04/04 | ✓ |   |
| AUDI       | A6 3.0                               | (4B, C5)  | 01    | 04/04 | ✓ |   |
| AUDI       | A6 3.7                               | (4B, C5)  | 99    | 04/04 | ✓ |   |
| AUDI       | A6                                   | (4F2)     | 05/04 | 12/04 | ✓ |   |
| AUDI       | A6 Allroad                           | (4BH)     | 00    | 04/04 | ✓ | ✓ |
| AUDI       | A6 Allroad Quattro                   | (4BH)     | 00    | 04/04 | ✓ | ✓ |
| AUDI       | A6 Avant                             | (4A, C4)  | 95    | 97    | ✓ |   |
| AUDI       | A6 Avant 1.8                         | (4B, C5)  | 97    | 04/04 | ✓ |   |
| AUDI       | A6 Avant 1.8 T 110 kW                | (4B, C5)  | 97    | 04/04 | ✓ |   |
| AUDI       | A6 Avant 1.8 T 132 kW                | (4B, C5)  | 97    | 04/04 | ✓ |   |
| AUDI       | A6 Avant 1.9 TDI                     | (4B, C5)  | 97    | 04/04 | ✓ |   |
| AUDI       | A6 Avant 2.0, 3.0                    | (4B, C5)  | 01    | 04/04 | ✓ |   |
| AUDI       | A6 Avant 2.4, 2.5 TDI, 2.7 T, 2.8    | (4B, C5)  | 97    | 04/04 | ✓ |   |
| AUDI       | A6 Avant 3.7                         | (4B, C5)  | 99    | 04/04 | ✓ |   |
| AUDI       | A6 Avant Quattro                     | (4A, C4)  | 94    | 97    | ✓ | ✓ |
| AUDI       | A6 Avant Quattro 1.8T 110kW          | (4B, C5)  | 97    | 04/04 | ✓ | ✓ |
| AUDI       | A6 Avant Quattro 1.8T 132kW          | (4B, C5)  | 97    | 04/04 | ✓ | ✓ |
| AUDI       | A6 Avant Quattro 2.4, 2.5 TDI        | (4B, C5)  | 97    | 04/04 | ✓ | ✓ |
| AUDI       | A6 Avant Quattro 2.7T, 2.8           | (4B, C5)  | 97    | 04/04 | ✓ | ✓ |
| AUDI       | A6 Avant Quattro 3.0                 | (4B, C5)  | 01    | 04/04 | ✓ | ✓ |
| AUDI       | A6 Avant Quattro 3.7                 | (4B, C5)  | 99    | 04/04 | ✓ | ✓ |
| AUDI       | A6 Quattro                           | (4A, C4)  | 94    | 97    | ✓ | ✓ |
| AUDI       | A6 Quattro 1.8 T 132kW, 2.4          | (4B, C5)  | 97    | 04/04 | ✓ |   |
| AUDI       | A6 Quattro 2.5TDI, 2.7T, 2.8         | (4B, C5)  | 97    | 04/04 | ✓ |   |
| AUDI       | A8                                   | (4D2,4D8) | 94    | 98    | ✓ |   |
| AUDI       | A8 Quattro                           | (4D2,4D8) | 94    | 96    | ✓ |   |
| AUDI       | A8 Quattro                           | (4D2,4D8) | 96    | 98    | ✓ | ✓ |
| AUDI       | Allroad                              |           | 07/02 | 04/04 | ✓ | ✓ |
| AUDI       | Allroad Quattro                      |           | 05/00 | 04/04 | ✓ | ✓ |
| AUDI       | RS2 Quattro                          |           | 94    | 95    | ✓ | ✓ |
| AUDI       | RS6 Quattro                          |           | 02    | 04    | ✓ | ✓ |
| SKODA      | Superb 1.9 TDI, 2,5V6TDI, 2.8V6 96kW |           | 02/02 | 06    | ✓ |   |
| VOLKSWAGEN | Passat 1.9 TDI                       | 81kW      | 97    | 00    | ✓ |   |
| VOLKSWAGEN | Passat 1.9 TDI                       | 85kW      | 11/00 | 05    | ✓ |   |
| VOLKSWAGEN | Passat 2.0 TDI                       |           | 12/03 | 05    | ✓ |   |
| VOLKSWAGEN | Passat 2.3 VR5                       |           | 96    | 05    | ✓ |   |
| VOLKSWAGEN | Passat 2.5 TDI                       |           | 98    | 05    | ✓ |   |
| VOLKSWAGEN | Passat 2.8 V6                        |           | 97    | 05    | ✓ |   |
| VOLKSWAGEN | Passat Syncro / 4 Motion 2.5 TDI     |           | 10/96 | 00    | ✓ |   |
| VOLKSWAGEN | Passat Syncro / 4 Motion 2.8 V6      |           | 10/96 | 00    | ✓ |   |
| VOLKSWAGEN | Passat 4 Motion 1.9 TDI              |           | 10/00 | 05    | ✓ |   |
| VOLKSWAGEN | Passat 4 Motion 2.3 VR5              |           | 11/00 | 05    | ✓ |   |
| VOLKSWAGEN | Passat 4 Motion 2.5 TDI, 2.8 V6      |           | 09/99 | 05    | ✓ |   |

**100 099**

|      |                               |        |       |       |   |  |
|------|-------------------------------|--------|-------|-------|---|--|
| AUDI | 80 2.3                        | 125 kW | 06/88 | 10/91 | ✓ |  |
| AUDI | 80 2.6 V6, 2.8 V6             |        | 91    | 94    | ✓ |  |
| AUDI | 80 Avant 2.6 V6, Avant 2.8 V6 |        | 92    | 96    | ✓ |  |
| AUDI | 80 Avant Quattro              |        | 92    | 95    | ✓ |  |

**100 099**

|      |                                    |           |       |       |   |   |
|------|------------------------------------|-----------|-------|-------|---|---|
| AUDI | 80 Quattro 2.3                     | 125 kW    | 05/88 | 09/91 | ✓ |   |
| AUDI | 80 Quattro 2.3                     | 125 kW    | 10/91 | 94    | ✓ |   |
| AUDI | 80 Quattro 2.6 V6, 2.6 V6          |           | 91    | 94    | ✓ |   |
| AUDI | 90 2.3 20V, Quattro 2.3 20V        | 125 kW    | 89    | 91    | ✓ |   |
| AUDI | 100, 100 Avant                     |           | 88    | 94    | ✓ |   |
| AUDI | 100 Automatic, 100 Avant Automatic |           | 90    | 94    | ✓ |   |
| AUDI | 100 Avant Quattro                  |           | 88    | 94    | ✓ | ✓ |
| AUDI | 200, 200 Avant Quattro             |           | 02/88 | 91    | ✓ |   |
| AUDI | Cabriolet 2.6 V6                   |           | 92    | 97    | ✓ |   |
| AUDI | Cabriolet 2.6 V6                   |           | 97    | 00    | ✓ |   |
| AUDI | Cabriolet 2.8 V6                   |           | 92    | 97    | ✓ |   |
| AUDI | Cabriolet 2.8 V6                   |           | 97    | 00    | ✓ |   |
| AUDI | Coupé 2.3 V5 20V                   |           | 89    | 91    | ✓ |   |
| AUDI | Coupé 2.6 V6, 2.8 V6               |           | 91    | 96    | ✓ |   |
| AUDI | Coupé Quattro 2.2                  |           | 89    | 96    | ✓ |   |
| AUDI | Coupé Quattro 2.3 V5 10V           |           | 89    | 94    | ✓ | ✓ |
| AUDI | Coupé Quattro 2.3 V5 20V           |           | 89    | 96    | ✓ |   |
| AUDI | Coupé Quattro 2.6 V6, 2.8 V6       |           | 89    | 96    | ✓ |   |
| AUDI | S2 Quattro                         |           | 92    | 96    | ✓ | ✓ |
| AUDI | S4 Quattro                         | (4A, C4)  | 91    | 94    | ✓ | ✓ |
| AUDI | S4 Quattro                         | (8D2, B5) | 97    | 01    | ✓ |   |
| AUDI | S4 Avant Quattro                   |           | 97    | 99    | ✓ |   |
| AUDI | S6 Quattro                         |           | 94    | 97    | ✓ | ✓ |
| AUDI | S8 Quattro                         |           | 97    | 01/99 | ✓ | ✓ |
| AUDI | V8 Quattro                         |           | 88    | 94    | ✓ | ✓ |

**100 206**

|            |                                  |    |    |    |   |  |
|------------|----------------------------------|----|----|----|---|--|
| VOLKSWAGEN | Transporter / Minibus            | T4 | 91 | 03 | ✓ |  |
| VOLKSWAGEN | Transporter / Minibus Syncro 4x4 | T4 | 91 | 03 | ✓ |  |

**101 010**

|            |                |  |    |       |   |  |
|------------|----------------|--|----|-------|---|--|
| VOLKSWAGEN | Caddy I        |  | 83 | 94    | ✓ |  |
| VOLKSWAGEN | Golf I         |  | 74 | 84    | ✓ |  |
| VOLKSWAGEN | Golf Cabriolet |  | 79 | 08/93 | ✓ |  |
| VOLKSWAGEN | Jetta          |  | 79 | 84    | ✓ |  |
| VOLKSWAGEN | Scirocco       |  | 74 | 92    | ✓ |  |

**101 016**



|            |                                 |  |       |       |   |  |
|------------|---------------------------------|--|-------|-------|---|--|
| SEAT       | Arosa                           |  | 97    | 04    | ✓ |  |
| VOLKSWAGEN | Golf II                         |  | 84    | 87    | ✓ |  |
| VOLKSWAGEN | Golf II Syncro                  |  | 86    | 87    | ✓ |  |
| VOLKSWAGEN | Jetta                           |  | 84    | 87    | ✓ |  |
| VOLKSWAGEN | Lupo 1.0, 1.4, 1.4 16V, 1.4 FSI |  | 99    | 06    | ✓ |  |
| VOLKSWAGEN | Lupo 1.4 TDI, 1.6 GTI, 1.7 SDI  |  | 99    | 06    | ✓ |  |
| VOLKSWAGEN | Polo                            |  | 08/94 | 10/01 | ✓ |  |

**101 017**

|            |                 |            |       |       |   |   |
|------------|-----------------|------------|-------|-------|---|---|
| AUDI       | A3              | (8P1)      | 05/03 | 12/03 | ✓ |   |
| AUDI       | A3              | (8P1, 8PA) | 12/03 | 05    | ✓ |   |
| AUDI       | A3 Quattro      | (8P1)      | 05/03 | 06    | ✓ | ✓ |
| AUDI       | S3 Quattro      | (8PA)      | 09/04 |       |   | ✓ |
| AUDI       | S3 Quattro      | (8PA)      | 09/04 |       |   | ✓ |
| AUDI       | TT              | (8J3)      | 10/06 |       |   | ✓ |
| SEAT       | Altea           |            | 03/04 | 06    | ✓ |   |
| SEAT       | Toledo III      |            | 10/04 | 06    | ✓ |   |
| SKODA      | Octavia         |            | 06/04 | 05    | ✓ |   |
| VOLKSWAGEN | Caddy III       |            | 03/04 | 06    | ✓ |   |
| VOLKSWAGEN | Eos             |            | 05/06 |       | ✓ |   |
| VOLKSWAGEN | EOS             |            | 03/06 | 06    | ✓ |   |
| VOLKSWAGEN | Golf V          |            | 10/03 | 06    | ✓ |   |
| VOLKSWAGEN | Golf V 4 Motion |            | 04    | 06    | ✓ | ✓ |
| VOLKSWAGEN | Jetta III       | (1K2)      | 08/05 | 06    | ✓ |   |
| VOLKSWAGEN | Passat          | (3C2)      | 03/05 |       | ✓ |   |
| VOLKSWAGEN | Passat 4 Motion | (3C2)      | 11/05 |       |   | ✓ |
| VOLKSWAGEN | Passat 4 Motion | (3C2)      | 11/05 |       | ✓ |   |
| VOLKSWAGEN | Touran          |            | 03    | 05    | ✓ |   |

**101 024**

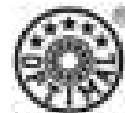
|      |                  |  |    |       |   |  |
|------|------------------|--|----|-------|---|--|
| SEAT | Toledo I 2.0 16V |  | 95 | 03/99 | ✓ |  |
|------|------------------|--|----|-------|---|--|



**101 024**



|            |                                    |        |    |    |   |
|------------|------------------------------------|--------|----|----|---|
| VOLKSWAGEN | Corrado 2.9 VR6                    | 91     | 95 | ✓  |   |
| VOLKSWAGEN | Golf III 1.9 GTI, 2.0 GTI, 2.8 VR6 | 92     | 98 | ✓  |   |
| VOLKSWAGEN | Golf III Syncro 2.9 VR6            | 93     | 98 | ✓  |   |
| VOLKSWAGEN | Passat 1.9 TDI                     | 81 kW  | 92 | 97 | ✓ |
| VOLKSWAGEN | Passat 2.0 16V                     | 110 kW | 92 | 97 | ✓ |
| VOLKSWAGEN | Passat 2.8 VR6                     | 02/92  | 97 | ✓  |   |
| VOLKSWAGEN | Passat Syncro 2.9 VR6              | 94     | 97 | ✓  |   |
| VOLKSWAGEN | Vento 2.0 16V, 2.8 VR6             | 92     | 98 | ✓  |   |

**101 025**



|            |                        |       |       |   |  |
|------------|------------------------|-------|-------|---|--|
| SEAT       | Ibiza IV 1.2           | 12/01 | 05/05 | ✓ |  |
| SKODA      | Fabia 1.0, 1.2, 1.4 8V | 12/99 | 06    | ✓ |  |
| VOLKSWAGEN | Polo 1.2               | 10/01 | 05    | ✓ |  |

**101 027**



|            |                                 |       |       |   |  |
|------------|---------------------------------|-------|-------|---|--|
| AUDI       | A2 1.4, 1.4 TDI (8Z0)           | 00    | 08/05 | ✓ |  |
| AUDI       | A2 1.6 FSI (8Z0)                | 02    | 08/05 | ✓ |  |
| SEAT       | Cordoba                         | 09/02 | 05    | ✓ |  |
| SEAT       | Ibiza IV 1.2, 1.4 16V           | 12/01 | 05/05 | ✓ |  |
| SEAT       | Ibiza IV 1.4 TDI, 1.6           | 02    | 05/05 | ✓ |  |
| SEAT       | Ibiza IV 1.8 T                  | 03    | 05/05 | ✓ |  |
| SEAT       | Ibiza IV 1.9 SDI, 1.9 TDI       | 12/01 | 05/05 | ✓ |  |
| SKODA      | Fabia 1.0, 1.2, 1.4 8V, 1.4 16V | 12/99 | 06    | ✓ |  |
| SKODA      | Fabia 1.9 Sdi, 1.9 Tdi, 2.0     | 00    | 06    | ✓ |  |
| VOLKSWAGEN | Fox 1.2, 1.4, 1.4 TDi           | 04/05 | 06    | ✓ |  |
| VOLKSWAGEN | Polo 1.2                        | 10/01 | 05    | ✓ |  |
| VOLKSWAGEN | Polo 1.4 16V, 1.4 FSI           | 10/01 | 06    | ✓ |  |
| VOLKSWAGEN | Polo 1.4 TDI, 1.9 SDI, 1.9 TDI  | 10/01 | 06    | ✓ |  |

**101 029**



|            |                  |    |       |   |  |
|------------|------------------|----|-------|---|--|
| AUDI       | A2 1.2 TDI (8Z0) | 01 | 08/05 | ✓ |  |
| VOLKSWAGEN | Lupo 1.2 TDI 3L  | 99 | 06    | ✓ |  |

**101 044**



|            |       |    |       |   |  |
|------------|-------|----|-------|---|--|
| AUDI       | 50    | 74 | 78    | ✓ |  |
| VOLKSWAGEN | Derby | 77 | 90    | ✓ |  |
| VOLKSWAGEN | Polo  | 75 | 07/94 | ✓ |  |

**101 064**



|            |       |       |       |   |  |
|------------|-------|-------|-------|---|--|
| VOLKSWAGEN | LT 28 | 76    | 06/96 | ✓ |  |
| VOLKSWAGEN | LT 31 | 76    | 96    | ✓ |  |
| VOLKSWAGEN | LT 35 | 04/86 | 06/96 | ✓ |  |

**101 102**



|            |                       |    |    |    |   |
|------------|-----------------------|----|----|----|---|
| VOLKSWAGEN | Transporter / Minibus | T3 | 80 | 84 | ✓ |
|------------|-----------------------|----|----|----|---|

**101 105**



|            |                                  |    |    |    |   |
|------------|----------------------------------|----|----|----|---|
| VOLKSWAGEN | Transporter / Minibus Syncro 4x4 | T3 | 84 | 90 | ✓ |
|------------|----------------------------------|----|----|----|---|

**101 108**



|            |                       |    |    |    |   |
|------------|-----------------------|----|----|----|---|
| VOLKSWAGEN | Transporter / Minibus | T3 | 84 | 90 | ✓ |
|------------|-----------------------|----|----|----|---|

**101 110**



|            |              |    |    |   |  |
|------------|--------------|----|----|---|--|
| VOLKSWAGEN | LT 40, LT 45 | 83 | 96 | ✓ |  |
| VOLKSWAGEN | LT 50, LT 55 | 84 | 96 | ✓ |  |

**101 111**



|      |                                       |    |    |   |  |
|------|---------------------------------------|----|----|---|--|
| AUDI | A4 2.4, 2.6, 2.8 (8D2, B5)            | 95 | 96 | ✓ |  |
| AUDI | A4 Avant 2.4, 2.6, 2.8 (8D5, B5)      | 95 | 96 | ✓ |  |
| AUDI | A4 Avant Quattro 2.6 (8D5, B5)        | 95 | 96 | ✓ |  |
| AUDI | A4 Avant Quattro 2.8 128 kW (8D5, B5) | 95 | 96 | ✓ |  |
| AUDI | A4 Quattro 2.6 (8D2, B5)              | 95 | 96 | ✓ |  |
| AUDI | A4 Quattro 2.8 128 kW (8D2, B5)       | 95 | 96 | ✓ |  |
| AUDI | A8 (4D2, 4D8)                         | 94 | 98 | ✓ |  |
| AUDI | A8 Quattro (4D2, 4D8)                 | 94 | 96 | ✓ |  |

**101 113**



|      |                  |    |       |   |   |
|------|------------------|----|-------|---|---|
| AUDI | A3 (8L1)         | 96 | 05/03 | ✓ |   |
| AUDI | A3 Quattro (8L1) | 99 | 05/03 | ✓ | ✓ |
| AUDI | S3 Quattro       | 99 | 03    | ✓ | ✓ |

**101 113**



|            |                     |       |       |   |   |
|------------|---------------------|-------|-------|---|---|
| AUDI       | TT                  | 98    | 04    | ✓ |   |
| AUDI       | TT Quattro          | 98    | 04    | ✓ | ✓ |
| SEAT       | Leon                | 00    | 04    | ✓ |   |
| SEAT       | Leon 4x4            | 00    | 04    | ✓ | ✓ |
| SEAT       | Toledo II           | 04/99 | 04    | ✓ |   |
| SKODA      | Octavia             | 96    | 06/04 | ✓ |   |
| SKODA      | Octavia 4x4         | 99    | 04    | ✓ | ✓ |
| VOLKSWAGEN | Bora                | 99    | 05    | ✓ |   |
| VOLKSWAGEN | Bora 4 Motion       | 99    | 05    | ✓ | ✓ |
| VOLKSWAGEN | Golf IV             | 98    | 04    | ✓ |   |
| VOLKSWAGEN | Golf IV 4 Motion    | 98    | 04    | ✓ | ✓ |
| VOLKSWAGEN | New Beetle          | 98    | 06    | ✓ |   |
| VOLKSWAGEN | New Beetle 4 Motion | 00    | 06    | ✓ | ✓ |

**101 128**



|            |                                  |    |    |    |   |
|------------|----------------------------------|----|----|----|---|
| VOLKSWAGEN | Transporter / Minibus            | T4 | 91 | 96 | ✓ |
| VOLKSWAGEN | Transporter / Minibus Syncro 4x4 | T4 | 91 | 96 | ✓ |

**101 145**



|            |                       |    |    |    |   |
|------------|-----------------------|----|----|----|---|
| VOLKSWAGEN | Transporter / Minibus | T2 | 71 | 79 | ✓ |
|------------|-----------------------|----|----|----|---|

**101 209**



|            |                                  |    |    |    |   |
|------------|----------------------------------|----|----|----|---|
| VOLKSWAGEN | Transporter / Minibus            | T4 | 96 | 03 | ✓ |
| VOLKSWAGEN | Transporter / Minibus Syncro 4x4 | T4 | 96 | 03 | ✓ |

**101 250**



|         |                |    |    |   |  |
|---------|----------------|----|----|---|--|
| PORSCHE | 911            | 80 | 89 | ✓ |  |
| PORSCHE | 924 Carrera GT | 80 | 85 | ✓ |  |
| PORSCHE | 924 Turbo      | 80 | 85 | ✓ |  |
| PORSCHE | 944            | 82 | 86 | ✓ |  |

**101 264**



|         |     |    |    |   |  |
|---------|-----|----|----|---|--|
| PORSCHE | 928 | 77 | 85 | ✓ |  |
|---------|-----|----|----|---|--|

**101 270**



|         |     |    |    |   |  |
|---------|-----|----|----|---|--|
| PORSCHE | 928 | 86 | 90 | ✓ |  |
| PORSCHE | 944 | 87 | 90 | ✓ |  |

**101 699**



|            |               |       |    |   |  |
|------------|---------------|-------|----|---|--|
| AUDI       | A3 (8P1, 8PA) | 12/03 | 05 | ✓ |  |
| SEAT       | Altea         | 03/04 | 06 | ✓ |  |
| SEAT       | Toledo III    | 10/04 | 06 | ✓ |  |
| VOLKSWAGEN | Caddy III     | 03/04 | 06 | ✓ |  |
| VOLKSWAGEN | Golf V        | 12/03 | 06 | ✓ |  |

**102 008**



|      |                                      |       |       |   |  |
|------|--------------------------------------|-------|-------|---|--|
| AUDI | 80                                   | 85    | 04/88 | ✓ |  |
| AUDI | 80 1.6                               | 92    | 94    | ✓ |  |
| AUDI | 80 1.8                               | 05/88 | 92    | ✓ |  |
| AUDI | 80 1.9, 2.0                          | 05/88 | 94    | ✓ |  |
| AUDI | 80 2.2                               | 05/88 | 92    | ✓ |  |
| AUDI | 80 2.3 125 kW                        | 06/88 | 10/91 | ✓ |  |
| AUDI | 80 2.3 100 kW                        | 91    | 94    | ✓ |  |
| AUDI | 80 2.6 V6, 2.8 V6                    | 91    | 94    | ✓ |  |
| AUDI | 80 Avant 1.6, 1.9, 2.0, 2.3          | 92    | 96    | ✓ |  |
| AUDI | 80 Avant 2.6 V6, 2.8 V6              | 92    | 96    | ✓ |  |
| AUDI | 90                                   | 85    | 04/88 | ✓ |  |
| AUDI | 90 1.6, 1.8, 2.0                     | 05/88 | 91    | ✓ |  |
| AUDI | 90 2.3 100 kW                        | 88    | 91    | ✓ |  |
| AUDI | 90 2.3 20V 125 kW                    | 89    | 91    | ✓ |  |
| AUDI | 100                                  | 77    | 94    | ✓ |  |
| AUDI | 100 Avant                            | 78    | 94    | ✓ |  |
| AUDI | 100 Automatic, 100 Avant Automatic   | 88    | 94    | ✓ |  |
| AUDI | 200                                  | 80    | 91    | ✓ |  |
| AUDI | A4 1.6 (8D2, B5)                     | 95    | 97    | ✓ |  |
| AUDI | A4 1.8, 1.8 T 110 kW (8D2, B5)       | 95    | 97    | ✓ |  |
| AUDI | A4 1.9 TDI, 2.4, 2.5 TDI (8D2, B5)   | 95    | 97    | ✓ |  |
| AUDI | A4 2.6, 2.8 (8D2, B5)                | 95    | 97    | ✓ |  |
| AUDI | A4 Avant 1.8, 1.8 T 110 kW (8D5, B5) | 95    | 97    | ✓ |  |

**102 008**

|            |                                  |           |    |    |   |
|------------|----------------------------------|-----------|----|----|---|
| AUDI       | A4 Avant 1.6, 1.9 TDI            | (8D5, B5) | 95 | 97 | ✓ |
| AUDI       | A4 Avant 2.4                     | (8D5, B5) | 95 | 97 | ✓ |
| AUDI       | A4 Avant 2.5 TDI                 | (8D5, B5) | 96 | 97 | ✓ |
| AUDI       | A4 Avant 2.6, 2.8                | (8D5, B5) | 95 | 97 | ✓ |
| AUDI       | A6                               | (4A, C4)  | 94 | 97 | ✓ |
| AUDI       | A6 Avant                         | (4A, C4)  | 95 | 97 | ✓ |
| AUDI       | Cabriolet 1.8, 1.9 TDI, 2.0, 2.3 |           | 91 | 97 | ✓ |
| AUDI       | Cabriolet 2.6 V6, 2.8 V6         |           | 92 | 97 | ✓ |
| AUDI       | Coupé 1.8, 2.0                   |           | 85 | 96 | ✓ |
| AUDI       | Coupé 2.3 V5 20V                 |           | 85 | 91 | ✓ |
| AUDI       | Coupé 2.6 V6, 2.8 V6             |           | 91 | 96 | ✓ |
| SEAT       | Inca                             |           | 95 | 97 | ✓ |
| VOLKSWAGEN | Caddy I                          |           | 83 | 94 | ✓ |
| VOLKSWAGEN | Caddy II                         |           | 95 | 97 | ✓ |

**102 009**

|            |        |  |    |    |   |
|------------|--------|--|----|----|---|
| VOLKSWAGEN | Golf V |  | 03 | 05 | ✓ |
|------------|--------|--|----|----|---|

**102 011**

|            |                                |          |       |       |   |
|------------|--------------------------------|----------|-------|-------|---|
| AUDI       | A6 1.8                         | (4B, C5) | 98    | 04/04 | ✓ |
| AUDI       | A6 1.8 T 110 kW, 132 kW        | (4B, C5) | 97    | 04/04 | ✓ |
| AUDI       | A6 1.9 TDI, 2.4, 2.5 TDI, 2.8  | (4B, C5) | 97    | 04/04 | ✓ |
| AUDI       | A6 2.7 T                       | (4B, C5) | 99    | 04/04 | ✓ |
| AUDI       | A6 3.0, Avant 2.0, Avant 3.0   | (4B, C5) | 01    | 04/04 | ✓ |
| AUDI       | A6 3.7, Avant 3.7              | (4B, C5) | 99    | 04/04 | ✓ |
| AUDI       | A6 Avant 1.8, 1.9 TDI          | (4B, C5) | 97    | 04/04 | ✓ |
| AUDI       | A6 Avant 1.8 T 110kW, 132kW    | (4B, C5) | 97    | 04/04 | ✓ |
| AUDI       | A6 Avant 2.4, 2.5 TDI          | (4B, C5) | 97    | 04/04 | ✓ |
| AUDI       | A6 Avant 2.7 T, 2.8            | (4B, C5) | 97    | 04/04 | ✓ |
| SKODA      | Superb 1.8 Turbo 20V           |          | 02/02 | 06    | ✓ |
| SKODA      | Superb 1.9 TDI 74 kW, 96 kW    |          | 02/02 | 06    | ✓ |
| SKODA      | Superb 2.0, 2.5 V6 TDI, 2.8 V6 |          | 02/02 | 06    | ✓ |
| VOLKSWAGEN | Passat 1.6, 1.8                |          | 97    | 04    | ✓ |
| VOLKSWAGEN | Passat 1.9 TDI 66 kW           |          | 97    | 00    | ✓ |
| VOLKSWAGEN | Passat 1.9 TDI 81 kW           |          | 97    | 00    | ✓ |
| VOLKSWAGEN | Passat 1.9 TDI 85 kW           |          | 98    | 05    | ✓ |
| VOLKSWAGEN | Passat 2.0 88 kW               |          | 04/00 | 11/00 | ✓ |
| VOLKSWAGEN | Passat 2.0 85 kW               |          | 11/00 | 05    | ✓ |
| VOLKSWAGEN | Passat 2.0 20V 96 kW           |          | 11/01 | 05    | ✓ |
| VOLKSWAGEN | Passat 2.0 TDI                 |          | 12/03 | 05    | ✓ |
| VOLKSWAGEN | Passat 2.3 VR5                 |          | 96    | 05    | ✓ |
| VOLKSWAGEN | Passat 2.5 TDI                 |          | 98    | 05    | ✓ |
| VOLKSWAGEN | Passat 2.8 V6                  |          | 97    | 05    | ✓ |
| VOLKSWAGEN | Santana                        |          | 97    | 03    | ✓ |

**102 015**

|            |                                 |       |       |       |   |
|------------|---------------------------------|-------|-------|-------|---|
| AUDI       | A2 1.4, 1.4 TDI                 | (8Z0) | 00    | 08/05 | ✓ |
| AUDI       | A2 1.6 FSI                      | (8Z0) | 02    | 08/05 | ✓ |
| SEAT       | Cordoba                         |       | 09/02 | 05    | ✓ |
| SEAT       | Ibiza IV 1.2, 1.4 16V           |       | 12/01 | 05/05 | ✓ |
| SEAT       | Ibiza IV 1.4 TDI, 1.6           |       | 02    | 05/05 | ✓ |
| SEAT       | Ibiza IV 1.8 T                  |       | 03    | 05/05 | ✓ |
| SEAT       | Ibiza IV 1.9 SDI, 1.9 TDI       |       | 12/01 | 05/05 | ✓ |
| SKODA      | Fabia 1.0, 1.2, 1.4 8V, 1.4 16V |       | 12/99 | 06    | ✓ |
| SKODA      | Fabia 1.9 Sdi, 1.9 Tdi, 2.0     |       | 00    | 06    | ✓ |
| VOLKSWAGEN | Polo 1.2, 1.4 16V, 1.4 FSI      |       | 10/01 | 05    | ✓ |
| VOLKSWAGEN | Polo 1.4 TDI, 1.9 SDI, 1.9 TDI  |       | 10/01 | 05    | ✓ |

**102 019**

|            |            |       |       |       |   |
|------------|------------|-------|-------|-------|---|
| AUDI       | A3         | (8P1) | 05/03 | 12/03 | ✓ |
| SEAT       | Toledo III |       | 10/04 | 06    | ✓ |
| VOLKSWAGEN | Caddy III  |       | 03/04 | 06    | ✓ |
| VOLKSWAGEN | Eos        |       | 05/06 |       | ✓ |
| VOLKSWAGEN | Golf V     |       | 10/03 | 12/03 | ✓ |
| VOLKSWAGEN | Passat     | (3C2) | 03/05 |       | ✓ |
| VOLKSWAGEN | Touran     |       | 03    | 05    | ✓ |

**102 041**

|      |                              |          |    |       |   |
|------|------------------------------|----------|----|-------|---|
| AUDI | A6 Quattro 1.8T 110kW, 132kW | (4B, C5) | 97 | 04/04 | ✓ |
|------|------------------------------|----------|----|-------|---|

**102 041**

|      |                         |          |    |       |   |
|------|-------------------------|----------|----|-------|---|
| AUDI | A6 Quattro 2.4, 2.5 TDI | (4B, C5) | 97 | 04/04 | ✓ |
| AUDI | A6 Quattro 2.7 T, 2.8   | (4B, C5) | 97 | 04/04 | ✓ |
| AUDI | A6 Quattro 3.7          | (4B, C5) | 99 | 04/04 | ✓ |

**102 054**

|            |              |  |    |    |   |
|------------|--------------|--|----|----|---|
| VOLKSWAGEN | LT 28, LT 31 |  | 76 | 83 | ✓ |
|------------|--------------|--|----|----|---|

**102 055**

|            |                                  |           |    |       |   |
|------------|----------------------------------|-----------|----|-------|---|
| AUDI       | A4 1.6, 2.4, 2.6, 2.8            | (8D2, B5) | 97 | 00    | ✓ |
| AUDI       | A4 1.8, 1.8 T 110 kW             | (8D2, B5) | 97 | 00    | ✓ |
| AUDI       | A4 1.8 T 132kW                   | (8D2, B5) | 97 | 00    | ✓ |
| AUDI       | A4 1.9 TDI, 2.5 TDI              | (8D2, B5) | 97 | 00    | ✓ |
| AUDI       | A4 Avant 1.6, 2.4, 2.6, 2.8      | (8D5, B5) | 97 | 01    | ✓ |
| AUDI       | A4 Avant 1.8, 1.8 T 110 kW       | (8D5, B5) | 97 | 01    | ✓ |
| AUDI       | A4 Avant 1.8 T 132kW             | (8D5, B5) | 97 | 01    | ✓ |
| AUDI       | A4 Avant 1.9 TDI, 2.5 TDU        | (8D5, B5) | 97 | 01    | ✓ |
| AUDI       | Cabriolet 1.8, 1.9 TDI, 2.0, 2.3 |           | 97 | 00    | ✓ |
| AUDI       | Cabriolet 2.6 V6, 2.8 V6         |           | 97 | 00    | ✓ |
| SEAT       | Inca                             |           | 97 | 05/99 | ✓ |
| VOLKSWAGEN | Caddy II                         |           | 97 | 04/99 | ✓ |

**102 060**

|            |       |  |    |       |   |
|------------|-------|--|----|-------|---|
| VOLKSWAGEN | LT 35 |  | 76 | 06/96 | ✓ |
| VOLKSWAGEN | LT 40 |  | 83 | 96    | ✓ |

**102 069**

|            |                 |       |    |       |   |
|------------|-----------------|-------|----|-------|---|
| AUDI       | A2 1.2 TDI      | (8Z0) | 01 | 08/05 | ✓ |
| VOLKSWAGEN | Lupo 1.2 TDI 3L |       | 99 | 06    | ✓ |

**102 071**

|      |              |           |    |       |   |
|------|--------------|-----------|----|-------|---|
| AUDI | A4, A4 Avant | (8E2, B6) | 00 | 10/04 | ✓ |
| AUDI | A4 Cabrio    | (8H7)     | 03 | 10/04 | ✓ |

**102 075**

|            |                                 |  |       |       |   |
|------------|---------------------------------|--|-------|-------|---|
| SEAT       | Arosa                           |  | 99    | 04    | ✓ |
| SEAT       | Cordoba                         |  | 99    | 08/02 | ✓ |
| SEAT       | Ibiza III                       |  | 08/99 | 02/02 | ✓ |
| VOLKSWAGEN | Lupo 1.0, 1.4, 1.4 16V, 1.4 FSI |  | 99    | 06    | ✓ |
| VOLKSWAGEN | Lupo 1.4 TDI, 1.6 GTI, 1.7 SDI  |  | 99    | 06    | ✓ |
| VOLKSWAGEN | Polo                            |  | 10/99 | 10/01 | ✓ |
| VOLKSWAGEN | Polo Classic, Variant           |  | 08/99 | 02    | ✓ |

**102 077**

|            |                                 |       |       |       |   |
|------------|---------------------------------|-------|-------|-------|---|
| AUDI       | A2 1.4, 1.4 TDI, 1.6 FSI        | (8Z0) | 00    | 08/05 | ✓ |
| SEAT       | Cordoba                         |       | 09/02 | 05    | ✓ |
| SEAT       | Ibiza IV 1.2, 1.4 16V           |       | 12/01 | 05/05 | ✓ |
| SEAT       | Ibiza IV 1.4 TDI, 1.6           |       | 02    | 05/05 | ✓ |
| SEAT       | Ibiza IV 1.8 T                  |       | 03    | 05/05 | ✓ |
| SEAT       | Ibiza IV 1.9 SDI, 1.9 TDI       |       | 12/01 | 05/05 | ✓ |
| SKODA      | Fabia 1.0, 1.2, 1.4 8V, 1.4 16V |       | 12/99 | 06    | ✓ |
| SKODA      | Fabia 1.9 Sdi, 1.9 Tdi, 2.0     |       | 00    | 06    | ✓ |
| VOLKSWAGEN | Fox 1.2, 1.4, 1.4 TDI           |       | 04/05 | 06    | ✓ |
| VOLKSWAGEN | Polo 1.2, 1.4 16V, 1.4 FSI      |       | 10/01 | 06    | ✓ |
| VOLKSWAGEN | Polo 1.4 TDI, 1.9 SDI, 1.9 TDI  |       | 10/01 | 06    | ✓ |

**102 079**

|            |          |  |       |    |   |
|------------|----------|--|-------|----|---|
| SEAT       | Inca     |  | 05/99 | 04 | ✓ |
| VOLKSWAGEN | Caddy II |  | 04/99 | 04 | ✓ |

**102 094**

|            |                                  |    |    |    |   |
|------------|----------------------------------|----|----|----|---|
| VOLKSWAGEN | Transporter / Minibus            | T2 | 71 | 79 | ✓ |
| VOLKSWAGEN | Transporter / Minibus            | T3 | 80 | 84 | ✓ |
| VOLKSWAGEN | Transporter / Minibus            | T3 | 84 | 90 | ✓ |
| VOLKSWAGEN | Transporter / Minibus Syncro 4x4 | T3 | 84 | 90 | ✓ |

**102 097**

|      |                     |           |    |       |   |
|------|---------------------|-----------|----|-------|---|
| AUDI | A4 Avant Quattro    | (8E5, B6) | 00 | 10/04 | ✓ |
| AUDI | A4 Cabrio Quattro   | (8H7)     | 03 | 10/04 | ✓ |
| AUDI | A4 Quattro          | (8E2, B6) | 00 | 10/04 | ✓ |
| AUDI | A6 2.0, Quattro 3.0 | (4B, C5)  | 01 | 04/04 | ✓ |

**SATZ-VERZEICHNIS  
KITS INDEX  
INDEX DES KITS**



**102 097**

|      |            |           |    |    |   |
|------|------------|-----------|----|----|---|
| AUDI | S4 Quattro | (8E2, B6) | 03 | 04 | ✓ |
|------|------------|-----------|----|----|---|

**102 103**

|         |     |  |       |    |   |
|---------|-----|--|-------|----|---|
| PORSCHE | 911 |  | 80    | 89 | ✓ |
| PORSCHE | 944 |  | 02/85 | 86 | ✓ |
| PORSCHE | 944 |  | 87    | 90 | ✓ |

**102 115**

|            |            |       |       |       |   |
|------------|------------|-------|-------|-------|---|
| AUDI       | A3         | (8L1) | 96    | 05/03 | ✓ |
| AUDI       | TT         |       | 98    | 04    | ✓ |
| SEAT       | Leon       |       | 00    | 04    | ✓ |
| SEAT       | Toledo II  |       | 04/99 | 04    | ✓ |
| SKODA      | Octavia    |       | 96    | 06/04 | ✓ |
| SKODA      | Octavia    |       | 06/04 | 05    | ✓ |
| VOLKSWAGEN | Bora       |       | 99    | 05    | ✓ |
| VOLKSWAGEN | Golf IV    |       | 98    | 04    | ✓ |
| VOLKSWAGEN | New Beetle |       | 98    | 06    | ✓ |

**102 150**

|            |              |  |    |    |   |
|------------|--------------|--|----|----|---|
| VOLKSWAGEN | LT 40, LT 45 |  | 83 | 96 | ✓ |
| VOLKSWAGEN | LT 50, LT 55 |  | 84 | 96 | ✓ |

**102 152**

|            |              |  |    |       |   |
|------------|--------------|--|----|-------|---|
| VOLKSWAGEN | LT 28, LT 31 |  | 83 | 03/86 | ✓ |
|------------|--------------|--|----|-------|---|

**102 154**

|            |                     |  |       |       |   |
|------------|---------------------|--|-------|-------|---|
| VOLKSWAGEN | LT 28, LT 31, LT 35 |  | 04/86 | 07/91 | ✓ |
|------------|---------------------|--|-------|-------|---|

**102 156**

|            |              |  |       |       |   |
|------------|--------------|--|-------|-------|---|
| VOLKSWAGEN | LT 28, LT 35 |  | 08/91 | 06/96 | ✓ |
| VOLKSWAGEN | LT 31        |  | 08/91 | 96    | ✓ |

**102 158**

|            |          |  |       |    |   |
|------------|----------|--|-------|----|---|
| SEAT       | Inca     |  | 05/99 | 04 | ✓ |
| VOLKSWAGEN | Caddy II |  | 04/99 | 04 | ✓ |

**102 207**

|            |                                  |    |    |    |   |
|------------|----------------------------------|----|----|----|---|
| VOLKSWAGEN | Transporter / Minibus            | T4 | 91 | 03 | ✓ |
| VOLKSWAGEN | Transporter / Minibus Syncro 4x4 | T4 | 91 | 03 | ✓ |

**102 213**

|            |           |            |       |    |   |
|------------|-----------|------------|-------|----|---|
| AUDI       | A3        | (8P1, 8PA) | 12/03 | 05 | ✓ |
| SEAT       | Altea     |            | 03/04 | 06 | ✓ |
| VOLKSWAGEN | EOS       |            | 03/06 | 06 | ✓ |
| VOLKSWAGEN | Golf V    |            | 12/03 | 06 | ✓ |
| VOLKSWAGEN | Jetta III | (1K2)      | 08/05 | 06 | ✓ |

**102 266**

|         |           |  |    |       |   |
|---------|-----------|--|----|-------|---|
| PORSCHE | 924       |  | 76 | 85    | ✓ |
| PORSCHE | 924 Turbo |  | 80 | 85    | ✓ |
| PORSCHE | 944       |  | 82 | 01/85 | ✓ |

**102 268**

|         |     |  |    |    |   |
|---------|-----|--|----|----|---|
| PORSCHE | 928 |  | 77 | 90 | ✓ |
|---------|-----|--|----|----|---|

**131 129**

|            |                   |  |       |    |   |
|------------|-------------------|--|-------|----|---|
| FORD       | Galaxy            |  | 05/95 | 05 | ✓ |
| FORD       | Galaxy 4x4        |  | 05/95 | 05 | ✓ |
| SEAT       | Alhambra          |  | 95    | 05 | ✓ |
| SEAT       | Alhambra 4 Motion |  | 00    | 05 | ✓ |
| VOLKSWAGEN | Sharan            |  | 95    | 05 | ✓ |
| VOLKSWAGEN | Sharan Syncro     |  | 96    | 00 | ✓ |
| VOLKSWAGEN | Sharan 4 Motion   |  | 00    | 05 | ✓ |

**132 131**

|            |          |  |       |    |   |
|------------|----------|--|-------|----|---|
| FORD       | Galaxy   |  | 05/95 | 05 | ✓ |
| SEAT       | Alhambra |  | 95    | 05 | ✓ |
| VOLKSWAGEN | Sharan   |  | 95    | 05 | ✓ |

**190 256**

|        |            |  |    |       |   |
|--------|------------|--|----|-------|---|
| TOYOTA | Hi-Lux 4WD |  | 84 | 07/88 | ✓ |
|--------|------------|--|----|-------|---|

**190 256**

|            |                              |                 |       |       |   |   |
|------------|------------------------------|-----------------|-------|-------|---|---|
| TOYOTA     | Landcruiser 3.4 Diesel       | (BJ4../6../7..) | 80    | 89    | ✓ | ✓ |
| TOYOTA     | Landcruiser 3.4 Turbo D.     | (BJ4../6../7..) | 80    | 89    | ✓ | ✓ |
| TOYOTA     | Landcruiser 4.0              | (FJ80)          | 90    | 94    | ✓ | ✓ |
| TOYOTA     | Landcruiser 4.0 Diesel       | (HJ60)          | 80    | 89    | ✓ | ✓ |
| TOYOTA     | Landcruiser 4.0 Turbo Diesel | (HJ61)          | 80    | 89    | ✓ | ✓ |
| TOYOTA     | Landcruiser 4.3              | (FJ40, FJ62)    | 80    | 02/89 | ✓ | ✓ |
| TOYOTA     | Toyo-Ace                     | (RY30)          | 09/84 | 07/85 | ✓ | ✓ |
| VOLKSWAGEN | Taro 2.2 4x4                 |                 | 89    | 97    | ✓ | ✓ |
| VOLKSWAGEN | Taro 2.4 Diesel 4x4          |                 | 89    | 97    | ✓ | ✓ |

**191 258**

|            |                          |                  |       |       |   |   |
|------------|--------------------------|------------------|-------|-------|---|---|
| TOYOTA     | Hi-Ace 2.4i 4WD          | (RZH109/119)     | 08/89 | 08/95 | ✓ | ✓ |
| TOYOTA     | Hi-Ace 2.4 D 4WD         | (LH108/118)      | 08/89 | 08/95 | ✓ | ✓ |
| TOYOTA     | Hi-Ace 2.8 D 4WD         | (LY151,LY161)    | 05/95 | 99    | ✓ | ✓ |
| TOYOTA     | Hi-Ace 3.0i 4WD          | (KZH138)         | 05/95 | 99    | ✓ | ✓ |
| TOYOTA     | Hi-Lux 4WD               |                  | 86    | 07/88 | ✓ | ✓ |
| TOYOTA     | Hi-Lux 4WD 2.2           | (YN106, YN110)   | 08/88 | 05/94 | ✓ | ✓ |
| TOYOTA     | Hi-Lux 4WD 2.4           | (RN61)           | 08/88 | 95    | ✓ | ✓ |
| TOYOTA     | Hi-Lux 4WD 2.4           | (RN67)           | 08/94 | 98    | ✓ | ✓ |
| TOYOTA     | Hi-Lux 4WD 2.4           | (RN106, RN110)   | 08/89 | 98    | ✓ | ✓ |
| TOYOTA     | Hi-Lux 4WD 2.4i          | (RZN168, RZN173) | 08/97 | 02    | ✓ | ✓ |
| TOYOTA     | Hi-Lux 4WD 2.4 D         | (LN105)          | 08/88 | 98    | ✓ | ✓ |
| TOYOTA     | Hi-Lux 4WD 2.4 D         | (LN108)          | 08/91 | 98    | ✓ | ✓ |
| TOYOTA     | Hi-Lux 4WD 2.4 D         | (LN110)          | 08/93 | 98    | ✓ | ✓ |
| TOYOTA     | Hi-Lux 4WD 2.4 TD        | (LN165, LN170)   | 08/97 | 03    | ✓ | ✓ |
| TOYOTA     | Hi-Lux 4WD 2.8 D         | (LN67)           | 08/95 | 98    | ✓ | ✓ |
| TOYOTA     | Hi-Lux 4-Runner 2.4 TD   | (LN130)          | 01/90 | 98    | ✓ | ✓ |
| TOYOTA     | Hi-Lux 4-Runner 3.0i 12V | (VZN130)         | 08/89 | 99    | ✓ | ✓ |
| TOYOTA     | Hi-Lux 4-Runner 3.0 TD   | (KZN130)         | 08/93 | 99    | ✓ | ✓ |
| VOLKSWAGEN | Taro 2.4 4x4             |                  | 89    | 97    | ✓ | ✓ |

**191 272**

|            |                              |               |       |       |   |   |
|------------|------------------------------|---------------|-------|-------|---|---|
| TOYOTA     | Hi-Ace 1.6                   | (RH11/20/30)  | 77    | 88    | ✓ | ✓ |
| TOYOTA     | Hi-Ace 1.8                   | (YH50/60)     | 82    | 88    | ✓ | ✓ |
| TOYOTA     | Hi-Ace 2.0i                  | (YH51/61)     | 84    | 89    | ✓ | ✓ |
| TOYOTA     | Hi-Ace 2.0i                  | (RZH102/112)  | 08/89 | 08/95 | ✓ | ✓ |
| TOYOTA     | Hi-Ace 2.0i                  | (YY101)       | 05/95 | 99    | ✓ | ✓ |
| TOYOTA     | Hi-Ace 2.2 D                 | (LH50/60/70)  | 82    | 88    | ✓ | ✓ |
| TOYOTA     | Hi-Ace 2.4i                  | (RZH103/113)  | 08/89 | 08/95 | ✓ | ✓ |
| TOYOTA     | Hi-Ace 2.4i                  | (RZH133)      | 05/95 | 97    | ✓ | ✓ |
| TOYOTA     | Hi-Ace 2.4i                  | (RCH12)       | 08/95 | 04    | ✓ | ✓ |
| TOYOTA     | Hi-Ace 2.4 D                 | (LH51/61)     | 84    | 88    | ✓ | ✓ |
| TOYOTA     | Hi-Ace 2.4 D                 | (LH102/112)   | 08/89 | 08/95 | ✓ | ✓ |
| TOYOTA     | Hi-Ace 2.4 D                 | (LXH12/22)    | 08/95 | 04    | ✓ | ✓ |
| TOYOTA     | Hi-Ace 2.4 TD                | (LH51/61)     | 87    | 95    | ✓ | ✓ |
| TOYOTA     | Hi-Ace 2.4 TD                | (LXH12/22)    | 08/95 | 04    | ✓ | ✓ |
| TOYOTA     | Hi-Ace 2.7i                  | (RCH13)       | 04/98 | 04    | ✓ | ✓ |
| TOYOTA     | Hi-Ace 2.8 D                 | (LY101,LY111) | 05/95 | 99    | ✓ | ✓ |
| TOYOTA     | Hi-Ace 3.0i                  | (KZH100)      | 05/95 | 99    | ✓ | ✓ |
| TOYOTA     | Hi-Ace 3.0i                  | (KZH110/120)  | 05/95 | 99    | ✓ | ✓ |
| TOYOTA     | Hi-Ace 3.0i                  | (KZH132)      | 05/95 | 99    | ✓ | ✓ |
| TOYOTA     | Hi-Lux 2WD                   |               | 78    | 07/88 | ✓ | ✓ |
| TOYOTA     | Hi-Lux 2WD 1.8               | (YN85, YN90)  | 08/88 | 05/94 | ✓ | ✓ |
| TOYOTA     | Hi-Lux 2WD 2.4               | (RN58)        | 07/94 | 98    | ✓ | ✓ |
| TOYOTA     | Hi-Lux 2WD 2.4 D             | (LN85, LN90)  | 08/88 | 08/97 | ✓ | ✓ |
| TOYOTA     | Hi-Lux 2WD 2.8 D             | (LN57)        | 08/95 | 98    | ✓ | ✓ |
| TOYOTA     | Kijang                       | (LF30, RF30)  | 01/81 | 09/85 | ✓ | ✓ |
| VOLKSWAGEN | Taro 1.8 4x2, 2.4 Diesel 4x2 |               | 89    | 97    | ✓ | ✓ |

**192 274**

|        |                              |              |    |       |   |   |
|--------|------------------------------|--------------|----|-------|---|---|
| TOYOTA | Hi-Ace 1.6                   | (RH11/20/30) | 77 | 88    | ✓ | ✓ |
| TOYOTA | Hi-Ace 1.8                   | (YH50/60)    | 82 | 88    | ✓ | ✓ |
| TOYOTA | Hi-Ace 2.0i                  | (YH51/61)    | 84 | 89    | ✓ | ✓ |
| TOYOTA | Hi-Lux 2WD                   |              | 78 | 07/88 | ✓ | ✓ |
| TOYOTA | Hi-Lux 4WD                   |              | 84 | 07/88 | ✓ | ✓ |
| TOYOTA | Hi-Lux 4WD                   |              | 86 | 07/88 | ✓ | ✓ |
| TOYOTA | Landcruiser 2.4              | (RJ70)       | 90 | 04/95 | ✓ | ✓ |
| TOYOTA | Landcruiser 3.0 Turbo Diesel | (KZJ70)      | 90 | 04/95 | ✓ | ✓ |

**192 274**

|            |                                |    |    |  |   |
|------------|--------------------------------|----|----|--|---|
| VOLKSWAGEN | Taro 1.8 4x2, 2.2 4x4, 2.4 4x4 | 89 | 97 |  | ✓ |
| VOLKSWAGEN | Taro 2.4 Diesel 4x2, 4x4       | 89 | 97 |  | ✓ |

**200 012**

|          |  |    |       |   |   |
|----------|--|----|-------|---|---|
| OPEL     | Ascona B 1.2, 1.3N, 1.3S, 1.6N, 1.6S     | 76 | 81    | ✓ |   |
| OPEL     | Ascona B 1.6N Automatic                  | 76 | 81    | ✓ |   |
| OPEL     | Ascona B 1.9, 2.0, 2.0 Diesel            | 76 | 81    | ✓ |   |
| OPEL     | Ascona C 1.3, 1.6 SV, 1.6 NZ, 1.6NS      | 82 | 88    |   | ✓ |
| OPEL     | Ascona C 1.6 SH, 1.6 Diesel, 1.8, 2.0    | 82 | 88    |   | ✓ |
| OPEL     | Corsa A                                  | 83 | 92    | ✓ |   |
| OPEL     | Corsa B                                  | 93 | 09/00 | ✓ |   |
| OPEL     | Kadett C 1.0, 1.2, 1.6, 1.9, 2.0         | 76 | 79    | ✓ |   |
| OPEL     | Kadett D 1.0, 1.2, 1.3                   | 80 | 84    |   | ✓ |
| OPEL     | Kadett D 1.6, 1.6 Diesel, 1.8            | 82 | 84    |   | ✓ |
| OPEL     | Kadett E 1.2, 1.3, 1.4, 1.8, 2.0         | 85 | 91    |   | ✓ |
| OPEL     | Kadett E 1.6 LZ, 1.6 NZ, 1.6 SV, 1.6 S   | 85 | 91    |   | ✓ |
| OPEL     | Kadett E 1.6 Diesel, 1.7 Diesel          | 85 | 91    |   | ✓ |
| OPEL     | Kadett E Cabriolet 1.4, 1.6 S, 2.0       | 85 | 93    |   | ✓ |
| OPEL     | Kadett E Cabriolet 1.6 LZ, 1.6 NZ, 1.6 S | 85 | 93    |   | ✓ |
| OPEL     | Manta B 1.2, 1.3 N, 1.3 S, 1.6 N, 1.6 S  | 76 | 88    | ✓ |   |
| OPEL     | Manta B 1.6 N Automatic, 1.9, 2.0        | 76 | 88    | ✓ |   |
| OPEL     | Rekord D, D Caravan                      | 72 | 77    | ✓ |   |
| OPEL     | Rekord E 1.7, 1.7 Caravan                | 78 | 82    | ✓ |   |
| OPEL     | Rekord E 1.8, 1.8 Caravan                | 83 | 86    | ✓ |   |
| OPEL     | Rekord E 1.9, 1.9 Caravan                | 78 | 82    | ✓ |   |
| OPEL     | Rekord E 2.0                             | 78 | 86    | ✓ |   |
| OPEL     | Rekord E 2.0 E Berlina                   | 81 | 84    | ✓ |   |
| OPEL     | Rekord E 2.2 E Berlina                   | 85 | 86    | ✓ |   |
| OPEL     | Tigra                                    | 94 | 00    |   | ✓ |
| OPEL     | Vectra A 1.4, 1.6, 1.6 Automatic         | 89 | 92    |   | ✓ |
| OPEL     | Vectra A 1.7 D, 1.7 TD, 1.8, 2.0         | 89 | 92    |   | ✓ |
| VAUXHALL | Astra 1.0                                | 80 | 84    |   | ✓ |
| VAUXHALL | Astra 1.2, 1.3                           | 80 | 91    |   | ✓ |
| VAUXHALL | Astra 1.6                                | 83 | 84    |   | ✓ |
| VAUXHALL | Astra 1.4, 1.6D, 1.6DA, 1.6S, 1.6LZ      | 85 | 91    |   | ✓ |
| VAUXHALL | Astra 1.6NZ, 1.6SV                       | 85 | 91    |   | ✓ |
| VAUXHALL | Astra 1.7 Diesel, 1.8, 2.0               | 85 | 91    |   | ✓ |
| VAUXHALL | Astra 1.8                                | 83 | 84    |   | ✓ |
| VAUXHALL | Belmont 1.2, 1.3, 1.4, 1.6 S, 1.6 Diesel | 86 | 91    |   | ✓ |
| VAUXHALL | Belmont 1.6 LZ, 1.6 NZ, 1.6 SV           | 86 | 91    |   | ✓ |
| VAUXHALL | Belmont 1.7 Diesel, 1.8, 2.0             | 86 | 91    |   | ✓ |
| VAUXHALL | Carlton                                  | 79 | 86    | ✓ |   |
| VAUXHALL | Cavalier 1300, 1600, 1900                | 76 | 81    | ✓ |   |
| VAUXHALL | Cavalier 1.3                             | 82 | 88    |   | ✓ |
| VAUXHALL | Cavalier 1.4                             | 89 | 93    |   | ✓ |
| VAUXHALL | Cavalier 1.6 NS, 1.6 SH, 1.6 NZ          | 82 | 88    |   | ✓ |
| VAUXHALL | Cavalier 1.6 SV, 1.6 Diesel              | 82 | 88    |   | ✓ |
| VAUXHALL | Cavalier 1.6, 1.6 Automatic              | 89 | 93    |   | ✓ |
| VAUXHALL | Cavalier 1.6                             | 94 | 95    |   | ✓ |
| VAUXHALL | Cavalier 1.7 Diesel, 1.7 Turbo Diesel    | 89 | 95    |   | ✓ |
| VAUXHALL | Cavalier 1.8                             | 82 | 88    |   | ✓ |
| VAUXHALL | Cavalier 1.8                             | 89 | 95    |   | ✓ |
| VAUXHALL | Cavalier 2.0 NE, 2.0 SEH                 | 89 | 95    |   | ✓ |
| VAUXHALL | Chevette                                 | 77 | 84    | ✓ |   |
| VAUXHALL | Corsa Mk I                               | 93 | 09/00 |   | ✓ |
| VAUXHALL | Nova                                     | 83 | 92    |   | ✓ |
| VAUXHALL | Tigra                                    | 94 | 05/04 |   | ✓ |

**200 020**

|      |                           |    |       |   |   |
|------|---------------------------|----|-------|---|---|
| OPEL | Commodore C               | 78 | 82    | ✓ |   |
| OPEL | Corsa B Combo             | 93 | 09/00 |   | ✓ |
| OPEL | Kadett E Combo            | 86 | 94    |   | ✓ |
| OPEL | Monza                     | 78 | 87    | ✓ |   |
| OPEL | Rekord E 1.7, 1.7 Caravan | 78 | 82    | ✓ |   |
| OPEL | Rekord E 1.9, 1.9 Caravan | 78 | 82    | ✓ |   |
| OPEL | Rekord E 2.0              | 78 | 86    | ✓ |   |
| OPEL | Rekord E 2.0 E Berlina    | 78 | 81    | ✓ |   |
| OPEL | Rekord E 2.0 Diesel       | 78 | 82    | ✓ |   |

**200 020**

|          |                                    |    |       |   |   |
|----------|------------------------------------|----|-------|---|---|
| OPEL     | Rekord E 2.1 Diesel                | 78 | 79    | ✓ |   |
| OPEL     | Rekord E 2.2 Turbo Diesel          | 85 | 86    | ✓ |   |
| OPEL     | Rekord E 2.3 Diesel                | 79 | 86    | ✓ |   |
| OPEL     | Senator A                          | 78 | 87    | ✓ |   |
| VAUXHALL | Carlton Diesel                     | 79 | 86    | ✓ |   |
| VAUXHALL | Corsa Mk I Combo                   | 93 | 09/00 |   | ✓ |
| VAUXHALL | Royal                              | 79 | 82    | ✓ |   |
| VAUXHALL | Viceroy                            | 80 | 82    | ✓ |   |
| VAUXHALL | Astramax 1.2 S, 1.3, 1.6 S, Diesel | 86 | 90    |   | ✓ |

**201 031**

|          |                                  |       |       |   |  |
|----------|----------------------------------|-------|-------|---|--|
| OPEL     | Astra G 1.8 16V Coupé            | 03/00 | 10/00 | ✓ |  |
| OPEL     | Astra G 2.0 16V, 2.0 DTI 16V     | 98    | 04    | ✓ |  |
| OPEL     | Astra G 2.2 16V, 2.2 DTI         | 00    | 04    | ✓ |  |
| OPEL     | Zafira                           | 99    | 04    | ✓ |  |
| VAUXHALL | Astra Mk IV 1.8 16V Coupé        | 00    | 00    | ✓ |  |
| VAUXHALL | Astra Mk IV 2.0 16V, 2.0 DTI 16V | 98    | 04    | ✓ |  |
| VAUXHALL | Zafira                           | 99    | 04    | ✓ |  |

**201 032**

|          |                                       |    |    |   |  |
|----------|---------------------------------------|----|----|---|--|
| OPEL     | Ascona C 1.6 NS, 1.6 SH               | 82 | 88 | ✓ |  |
| OPEL     | Ascona C 1.6 Diesel, 1.8, 2.0         | 82 | 88 | ✓ |  |
| OPEL     | Astra F 1.4, 1.6, 1.8, 2.0            | 92 | 98 | ✓ |  |
| OPEL     | Astra F 1.7 D, 1.7 TD, 1.7 TDS        | 92 | 98 | ✓ |  |
| OPEL     | Calibra C20NE, X20XE                  | 89 | 95 | ✓ |  |
| OPEL     | Calibra C20XE                         | 89 | 97 | ✓ |  |
| OPEL     | Calibra C20LET                        | 89 | 92 | ✓ |  |
| OPEL     | Kadett D 1.6, 1.6 Diesel, 1.8         | 82 | 84 | ✓ |  |
| OPEL     | Kadett E 1.6 S, 1.6 Diesel            | 85 | 91 | ✓ |  |
| OPEL     | Kadett E 1.7 Diesel, 1.8, 2.0         | 85 | 91 | ✓ |  |
| OPEL     | Kadett E Cabriolet 1.6 S, 2.0         | 85 | 93 | ✓ |  |
| OPEL     | Kadett E Combo                        | 86 | 94 | ✓ |  |
| OPEL     | Meriva 1.7 CDTI                       | 03 | 05 | ✓ |  |
| OPEL     | Vectra A 1.6 Automatic                | 89 | 92 | ✓ |  |
| OPEL     | Vectra A 1.6 Automatic                | 93 | 93 | ✓ |  |
| OPEL     | Vectra A 1.7 D, 1.7 TD                | 89 | 92 | ✓ |  |
| OPEL     | Vectra A 1.7 D, 1.7 TD                | 93 | 95 | ✓ |  |
| OPEL     | Vectra A 1.8, 2.0                     | 89 | 95 | ✓ |  |
| OPEL     | Vectra A 2.0 4x4                      | 89 | 92 | ✓ |  |
| VAUXHALL | Astra 1.6                             | 83 | 84 | ✓ |  |
| VAUXHALL | Astra 1.6D, 1.6DA, 1.6S               | 85 | 91 | ✓ |  |
| VAUXHALL | Astra 1.7 Diesel                      | 85 | 91 | ✓ |  |
| VAUXHALL | Astra 1.8                             | 83 | 84 | ✓ |  |
| VAUXHALL | Astra 1.8, 2.0                        | 85 | 91 | ✓ |  |
| VAUXHALL | Astra Mk III 1.4, 1.6, 1.8, 2.0       | 92 | 98 | ✓ |  |
| VAUXHALL | Astra Mk III 1.7 Diesel, 1.7 Turbo D. | 92 | 98 | ✓ |  |
| VAUXHALL | Belmont 1.6 S, 1.6 Diesel             | 86 | 91 | ✓ |  |
| VAUXHALL | Belmont 1.7 Diesel, 1.8, 2.0          | 86 | 91 | ✓ |  |
| VAUXHALL | Calibra C20NE, X20XE                  | 89 | 95 | ✓ |  |
| VAUXHALL | Calibra C20XE                         | 89 | 97 | ✓ |  |
| VAUXHALL | Calibra C20LET                        | 89 | 92 | ✓ |  |
| VAUXHALL | Cavalier 1.6 NS, 1.6 SH, 1.6 Diesel   | 82 | 88 | ✓ |  |
| VAUXHALL | Cavalier 1.6 Automatic                | 89 | 93 | ✓ |  |
| VAUXHALL | Cavalier 1.7 Diesel                   | 82 | 88 | ✓ |  |
| VAUXHALL | Cavalier 1.7 Diesel, 1.7 Turbo Diesel | 89 | 95 | ✓ |  |
| VAUXHALL | Cavalier 1.8                          | 82 | 88 | ✓ |  |
| VAUXHALL | Cavalier 1.8                          | 89 | 95 | ✓ |  |
| VAUXHALL | Cavalier 2.0                          | 82 | 88 | ✓ |  |
| VAUXHALL | Cavalier 2.0 NE, 2.0 SEH              | 89 | 95 | ✓ |  |
| VAUXHALL | Cavalier 2.0 XE 16V                   | 92 | 95 | ✓ |  |
| VAUXHALL | Cavalier 2.0i Turbo 4x4               | 92 | 92 | ✓ |  |
| VAUXHALL | Meriva 1.7 CDTI                       | 03 | 05 | ✓ |  |
| VAUXHALL | Astramax 1.6 S, Diesel                | 86 | 90 | ✓ |  |

**201 033**

|      |                 |    |    |   |  |
|------|-----------------|----|----|---|--|
| OPEL | Astra G 1.2 16V | 98 | 00 | ✓ |  |
| OPEL | Astra G 1.4 16V | 98 | 04 | ✓ |  |
| OPEL | Astra G 1.6     | 98 | 00 | ✓ |  |



**201 033**



|          |                                   |    |    |   |  |
|----------|-----------------------------------|----|----|---|--|
| OPEL     | Astra G 1.6 16V                   | 98 | 04 | ✓ |  |
| OPEL     | Astra G 1.7 TD                    | 98 | 00 | ✓ |  |
| OPEL     | Astra G 1.7 DTI 16V               | 00 | 04 | ✓ |  |
| OPEL     | Astra G 1.8 16V                   | 98 | 00 | ✓ |  |
| OPEL     | Astra G 2.0 DI                    | 98 | 04 | ✓ |  |
| VAUXHALL | Astra Mk IV 1.2 16V, 1.6, 1.7 TD, | 98 | 00 | ✓ |  |
| VAUXHALL | Astra Mk IV 1.4 16V, 1.6 16V      | 98 | 04 | ✓ |  |
| VAUXHALL | Astra Mk IV 1.8 16V               | 98 | 00 | ✓ |  |
| VAUXHALL | Astra Mk IV 1.7 DTI 16V           | 00 | 04 | ✓ |  |
| VAUXHALL | Astra Mk IV 2.0 DI 16V            | 98 | 04 | ✓ |  |

**201 035**



|          |                         |    |    |   |  |
|----------|-------------------------|----|----|---|--|
| OPEL     | Astra G 1.2 16V         | 98 | 00 | ✓ |  |
| OPEL     | Astra G 1.4 16V         | 98 | 04 | ✓ |  |
| OPEL     | Astra G 1.6             | 98 | 00 | ✓ |  |
| OPEL     | Astra G 1.6 16V         | 98 | 04 | ✓ |  |
| OPEL     | Astra G 1.7 TD          | 98 | 00 | ✓ |  |
| OPEL     | Astra G 1.7 DTI 16V     | 00 | 04 | ✓ |  |
| OPEL     | Astra G 2.0 DI          | 98 | 99 | ✓ |  |
| VAUXHALL | Astra Mk IV 1.2 16V     | 98 | 00 | ✓ |  |
| VAUXHALL | Astra Mk IV 1.4 16V     | 98 | 04 | ✓ |  |
| VAUXHALL | Astra Mk IV 1.6         | 98 | 00 | ✓ |  |
| VAUXHALL | Astra Mk IV 1.6 16V     | 98 | 04 | ✓ |  |
| VAUXHALL | Astra Mk IV 1.7 TD      | 98 | 00 | ✓ |  |
| VAUXHALL | Astra Mk IV 1.7 DTI 16V | 00 | 04 | ✓ |  |
| VAUXHALL | Astra Mk IV 2.0 DI 16V  | 98 | 99 | ✓ |  |

**201 040**



|          |  |    |    |   |  |
|----------|--|----|----|---|--|
| OPEL     | Ascona C 1.3, 1.6 SV, 1.6 NZ             | 82 | 88 | ✓ |  |
| OPEL     | Astra F 1.4, 1.6                         | 92 | 98 | ✓ |  |
| OPEL     | Corsa A                                  | 83 | 92 | ✓ |  |
| OPEL     | Kadett D 1.0, 1.2, 1.3                   | 80 | 84 | ✓ |  |
| OPEL     | Kadett E 1.2, 1.3, 1.4                   | 85 | 91 | ✓ |  |
| OPEL     | Kadett E 1.6 LZ, 1.6 NZ, 1.6 SV          | 85 | 91 | ✓ |  |
| OPEL     | Kadett E Cabriolet 1.4                   | 85 | 93 | ✓ |  |
| OPEL     | Kadett E Cabriolet 1.6 LZ, 1.6 NZ, 1.6 S | 85 | 93 | ✓ |  |
| OPEL     | Vectra A 1.4, 1.6                        | 89 | 93 | ✓ |  |
| VAUXHALL | Astra 1.0                                | 80 | 84 | ✓ |  |
| VAUXHALL | Astra 1.2, 1.3                           | 80 | 91 | ✓ |  |
| VAUXHALL | Astra 1.4                                | 85 | 91 | ✓ |  |
| VAUXHALL | Astra 1.6LZ, 1.6NZ, 1.6SV                | 85 | 91 | ✓ |  |
| VAUXHALL | Astra Mk III 1.4, 1.6                    | 92 | 98 | ✓ |  |
| VAUXHALL | Belmont 1.2, 1.3, 1.4                    | 86 | 91 | ✓ |  |
| VAUXHALL | Belmont 1.6 LZ, 1.6 NZ, 1.6 SV           | 86 | 91 | ✓ |  |
| VAUXHALL | Cavalier 1.4, 1.6                        | 89 | 93 | ✓ |  |
| VAUXHALL | Cavalier 1.3, 1.6 NZ, 1.6 SV             | 82 | 88 | ✓ |  |
| VAUXHALL | Nova                                     | 83 | 92 | ✓ |  |
| VAUXHALL | Astramax 1.2 S, 1.3                      | 86 | 90 | ✓ |  |

**201 043**



|          |                                      |       |       |   |   |
|----------|--------------------------------------|-------|-------|---|---|
| OPEL     | Astra G 1.8 16V                      | 98    | 00    | ✓ |   |
| OPEL     | Astra G 1.8 16V Coupé                | 03/00 | 10/00 | ✓ |   |
| OPEL     | Astra G 2.0 16V, 2.0 DI, 2.0 DTI 16V | 98    | 04    | ✓ |   |
| OPEL     | Astra G 2.2 16V, 2.0 DTI             | 00    | 04    | ✓ |   |
| OPEL     | Speedster                            | 00    | 05    | ✓ | ✓ |
| OPEL     | Zafira                               | 99    | 04    | ✓ |   |
| VAUXHALL | Astra Mk IV 1.8 16V                  | 98    | 00    | ✓ |   |
| VAUXHALL | Astra Mk IV 1.8 16V Coupé            | 00    | 00    | ✓ |   |
| VAUXHALL | Astra Mk IV 2.0 16V, 2.0 DI 16V      | 98    | 04    | ✓ |   |
| VAUXHALL | Astra Mk IV 2.0 DTI 16V              | 98    | 04    | ✓ |   |
| VAUXHALL | VX 220 2.0i Turbo                    | 03    | 05    | ✓ | ✓ |
| VAUXHALL | VX 220 2.2i                          | 00    | 05    | ✓ | ✓ |
| VAUXHALL | Zafira                               | 99    | 04    | ✓ |   |

**201 084**



|      |                                |    |    |   |  |
|------|--------------------------------|----|----|---|--|
| OPEL | Omega A 1.8, 2.0, 2.3 Diesel   | 87 | 93 | ✓ |  |
| OPEL | Omega A 2.3 Turbo Diesel       | 87 | 93 | ✓ |  |
| OPEL | Omega A 2.4, 2.6, 3.0, Caravan | 87 | 93 | ✓ |  |

**201 084**



|          |                              |    |       |   |  |
|----------|------------------------------|----|-------|---|--|
| OPEL     | Omega A 3.6 24V Lotus        | 90 | 93    | ✓ |  |
| OPEL     | Omega B, Omega B Caravan     | 94 | 07/03 | ✓ |  |
| OPEL     | Senator B                    | 88 | 93    | ✓ |  |
| VAUXHALL | Carlton 1.8, 2.0, 2.3 Diesel | 87 | 93    | ✓ |  |
| VAUXHALL | Carlton 2.3 Turbo Diesel     | 87 | 93    | ✓ |  |
| VAUXHALL | Carlton 2.4, 2.6, 3.0        | 87 | 93    | ✓ |  |
| VAUXHALL | Carlton 3.6 24V Lotus        | 90 | 93    | ✓ |  |
| VAUXHALL | Omega, Omega Caravan         | 94 | 03    | ✓ |  |
| VAUXHALL | Senator 2.5i                 | 88 | 93    | ✓ |  |
| VAUXHALL | Senator 3.0i                 | 88 | 93    | ✓ |  |

**201 085**



|          |           |       |    |   |  |
|----------|-----------|-------|----|---|--|
| NISSAN   | Primaster | 01    | 03 | ✓ |  |
| OPEL     | Vivaro    | 01    | 03 | ✓ |  |
| RENAULT  | Trafic II | 03/01 | 05 | ✓ |  |
| VAUXHALL | Vivaro    | 01    | 05 | ✓ |  |

**201 087**



|          |                              |       |       |   |  |
|----------|------------------------------|-------|-------|---|--|
| OPEL     | Agila                        | 00    | 04    | ✓ |  |
| SUZUKI   | Wagon R+ 1.0i (EM)           | 97    | 05/00 | ✓ |  |
| SUZUKI   | Wagon R+ 1.2i, 1.2i 4WD (EM) | 98    | 05/00 | ✓ |  |
| SUZUKI   | Wagon R+ 1.3i (MM)           | 05/00 | 04    | ✓ |  |
| SUZUKI   | Wagon R+ 1.3i 4WD (MM)       | 10/01 | 04    | ✓ |  |
| SUZUKI   | Wagon R+ 1.3 DDiS (MM)       | 09/03 | 04    | ✓ |  |
| VAUXHALL | Agila                        | 00    | 04    | ✓ |  |

**201 089**



|          |           |       |    |   |  |
|----------|-----------|-------|----|---|--|
| NISSAN   | Primaster | 01    | 03 | ✓ |  |
| OPEL     | Vivaro    | 01    | 03 | ✓ |  |
| RENAULT  | Trafic II | 03/01 | 05 | ✓ |  |
| VAUXHALL | Vivaro    | 01    | 05 | ✓ |  |

**201 095**



|          |                                   |       |    |   |  |
|----------|-----------------------------------|-------|----|---|--|
| OPEL     | Corsa C, C Combo                  | 10/00 | 05 | ✓ |  |
| OPEL     | Meriva 1.3 CDTI, 1.4 16V Twinport | 04    | 05 | ✓ |  |
| OPEL     | Meriva 1.6, 1.6 16V, 1.7 DTI, 1.8 | 03    | 05 | ✓ |  |
| OPEL     | Tigra TwinTop                     | 04    | 05 | ✓ |  |
| VAUXHALL | Corsa Mk II, Corsa Mk II Combo    | 10/00 | 05 | ✓ |  |
| VAUXHALL | Meriva 1.3 CDTI                   | 03    | 05 | ✓ |  |
| VAUXHALL | Meriva 1.4 16V Twinport           | 04    | 05 | ✓ |  |
| VAUXHALL | Meriva 1.6, 1.6 16V, 1.7 DTI, 1.8 | 03    | 05 | ✓ |  |

**201 210**



|          |                        |    |       |   |  |
|----------|------------------------|----|-------|---|--|
| OPEL     | Astra F 1.4, 1.6       | 92 | 98    | ✓ |  |
| OPEL     | Astra Classic          | 99 | 02    | ✓ |  |
| OPEL     | Corsa B, Corsa B Combo | 93 | 09/00 | ✓ |  |
| OPEL     | Tigra                  | 94 | 00    | ✓ |  |
| OPEL     | Vectra A 1.6           | 94 | 95    | ✓ |  |
| VAUXHALL | Astra Mk III 1.4, 1.6  | 92 | 98    | ✓ |  |
| VAUXHALL | Astra Classic          | 99 | 02    | ✓ |  |
| VAUXHALL | Cavalier 1.6           | 94 | 95    | ✓ |  |
| VAUXHALL | Corsa Mk I             | 93 | 09/00 | ✓ |  |
| VAUXHALL | Corsa Mk I Combo       | 93 | 09/00 | ✓ |  |
| VAUXHALL | Tigra                  | 94 | 05/04 | ✓ |  |

**201 228**



|          |                                      |    |       |   |   |
|----------|--------------------------------------|----|-------|---|---|
| OPEL     | Astra F 1.4, 1.6, 1.8, 2.0           | 92 | 98    | ✓ |   |
| OPEL     | Astra F 1.7 D, 1.7 TD, 1.7 TDS       | 92 | 98    | ✓ |   |
| OPEL     | Calibra C20NE, X20XE, C20XE          | 96 | 97    | ✓ |   |
| OPEL     | Calibra C20LET, C25XE, X25XE         | 93 | 97    | ✓ |   |
| OPEL     | Omega B                              | 94 | 07/03 | ✓ | ✓ |
| OPEL     | Vectra A 2.0 4x4, 2.5 6V, 2.5 6V 4x4 | 93 | 95    | ✓ |   |
| OPEL     | Vectra B 1.6 i, 1.6 i 16V, 1.7 TD    | 95 | 98    | ✓ |   |
| OPEL     | Vectra B 1.8 i 16V, 2.0 i, 2.0 i 16V | 95 | 98    | ✓ |   |
| OPEL     | Vectra B 2.0 DI 16V                  | 96 | 98    | ✓ |   |
| OPEL     | Vectra B 2.0 DTI 16V                 | 97 | 98    | ✓ |   |
| OPEL     | Vectra B 2.5 i V6                    | 95 | 98    | ✓ |   |
| OPEL     | Vectra B                             | 99 | 02    | ✓ |   |
| VAUXHALL | Astra Mk III 1.4, 1.6, 1.8, 2.0      | 92 | 98    | ✓ |   |

**201 228**

|          |   |    |       |   |   |
|----------|---|----|-------|---|---|
| VAUXHALL | Astra Mk III 1.7 Diesel, 1.7 Turbo Dies | 92 | 98    | ✓ |   |
| VAUXHALL | Calibra C20NE, X20XE, C20XE             | 96 | 97    | ✓ |   |
| VAUXHALL | Calibra C20LET, C25XE, X25XE            | 93 | 97    | ✓ |   |
| VAUXHALL | Cavalier 2.0i Turbo 4x4                 | 93 | 94    | ✓ |   |
| VAUXHALL | Cavalier 2.5 XE V6                      | 93 | 95    | ✓ |   |
| VAUXHALL | Cavalier 2.5 XE V6 4x4                  | 95 | 95    | ✓ |   |
| VAUXHALL | Omega                                   | 94 | 03    |   | ✓ |
| VAUXHALL | Vectra Mk I 1.6, 1.7 TD, 1.8 16V, 2.0   | 96 | 98    | ✓ |   |
| VAUXHALL | Vectra Mk I 2.0 16V, 2.0 DI 16V         | 96 | 98    | ✓ |   |
| VAUXHALL | Vectra Mk I 2.0 DTI 16V, 2.5i V6        | 96 | 98    | ✓ |   |
| VAUXHALL | Vectra Mk I                             | 99 | 03/02 | ✓ |   |

**201 262**

|          |  |       |       |   |  |
|----------|--|-------|-------|---|--|
| HONDA    | Jazz 2.6, 3.2 (CG5, CY5)               | 11/93 | 94    | ✓ |  |
| HONDA    | Passport 2.6, 3.2 (CG5, CY5)           | 11/93 | 94    | ✓ |  |
| ISUZU    | Trooper I 2.2 D, 2.3 (UBS)             | 01/86 | 88    | ✓ |  |
| ISUZU    | Trooper I 2.6i, 2.8 TD (UBS)           | 88    | 91    | ✓ |  |
| ISUZU    | Trooper II 3.1 D, 3.2 (UB)             | 91    | 98    | ✓ |  |
| ISUZU    | Trooper III 3.0 DTI, 3.5i V6 24V       | 00    | 02    | ✓ |  |
| OPEL     | Campo 4x4 (TFR)                        | 91    | 00    | ✓ |  |
| OPEL     | Frontera A 2.0i Catalytic, 2.0i Ecotec | 92    | 98    | ✓ |  |
| OPEL     | Frontera A 2.2i, 2.3 TD, 2.4i          | 92    | 98    | ✓ |  |
| OPEL     | Frontera A 2.5 TDS, 2.8 TD             | 92    | 98    | ✓ |  |
| OPEL     | Frontera B                             | 99    | 04    | ✓ |  |
| OPEL     | Monterey A 3.1 TD, 3.2i V6 24V         | 91    | 07/98 | ✓ |  |
| OPEL     | Monterey B 3.0 TDI 16V, 3.5i V6 26V    | 07/98 | 99    | ✓ |  |
| VAUXHALL | Frontera                               | 91    | 04    | ✓ |  |
| VAUXHALL | Monterey I 3.1 TD, 3.2i V6 24V         | 91    | 98    | ✓ |  |
| VAUXHALL | Monterey II 3.0 TDI 16V, 3.5i V6 26V   | 98    | 99    | ✓ |  |
| VAUXHALL | Brava 4x4 (TFS)                        | 91    | 95    | ✓ |  |

**201 517**

|          |              |       |       |   |  |
|----------|--------------|-------|-------|---|--|
| OPEL     | Signum       | 03    | 01/05 | ✓ |  |
| OPEL     | Vectra C     | 02    | 01/05 | ✓ |  |
| SAAB     | 9-3          | 09/02 | 06    | ✓ |  |
| VAUXHALL | Signum       | 03    | 01/05 | ✓ |  |
| VAUXHALL | Vectra Mk II | 02    | 01/05 | ✓ |  |

**201 621**

|          |                 |       |    |   |  |
|----------|-----------------|-------|----|---|--|
| OPEL     | Astra H         | 03/04 | 06 | ✓ |  |
| OPEL     | Astra H TwinTop | 09/05 | 06 | ✓ |  |
| VAUXHALL | Astra Mk V      | 03/04 | 05 | ✓ |  |

**201 623**

|          |                 |       |    |   |  |
|----------|-----------------|-------|----|---|--|
| OPEL     | Astra H         | 03/04 | 06 | ✓ |  |
| OPEL     | Astra H TwinTop | 09/05 | 06 | ✓ |  |
| OPEL     | Zafira          | 07/05 | 06 | ✓ |  |
| VAUXHALL | Astra Mk V      | 03/04 | 05 | ✓ |  |

**201 671**

|          |        |    |    |   |  |
|----------|--------|----|----|---|--|
| OPEL     | Sintra | 96 | 99 | ✓ |  |
| VAUXHALL | Sintra | 96 | 99 | ✓ |  |

**201 691**

|          |              |       |    |   |  |
|----------|--------------|-------|----|---|--|
| OPEL     | Signum       | 01/05 | 06 | ✓ |  |
| OPEL     | Vectra C     | 01/05 | 06 | ✓ |  |
| VAUXHALL | Signum       | 01/05 | 06 | ✓ |  |
| VAUXHALL | Vectra Mk II | 01/05 | 06 | ✓ |  |

**202 021**

|          |               |       |    |   |  |
|----------|---------------|-------|----|---|--|
| OPEL     | Corsa C       | 10/00 | 05 | ✓ |  |
| OPEL     | Tigra TwinTop | 04    | 05 | ✓ |  |
| VAUXHALL | Corsa Mk II   | 10/00 | 05 | ✓ |  |

**202 023**

|          |               |       |    |   |  |
|----------|---------------|-------|----|---|--|
| OPEL     | Corsa C       | 10/00 | 05 | ✓ |  |
| OPEL     | Tigra TwinTop | 04    | 05 | ✓ |  |
| VAUXHALL | Corsa Mk II   | 10/00 | 05 | ✓ |  |

**202 026**

|          |                              |    |    |   |  |
|----------|------------------------------|----|----|---|--|
| OPEL     | Omega A 1.8, 2.0, 2.3 Diesel | 87 | 93 | ✓ |  |
| VAUXHALL | Carlton 1.8, 2.0, 2.3 Diesel | 87 | 93 | ✓ |  |

**202 059**

|          |                                  |       |       |   |  |
|----------|----------------------------------|-------|-------|---|--|
| OPEL     | Astra G 1.8 16V Coupé            | 03/00 | 10/00 | ✓ |  |
| OPEL     | Astra G 2.0 16V, 2.0 DTI 16V     | 98    | 04    | ✓ |  |
| OPEL     | Astra G 2.2 16V, 2.2 DTI         | 00    | 04    | ✓ |  |
| OPEL     | Meriva 1.7 CDTI                  | 03    | 05    | ✓ |  |
| OPEL     | Zafira                           | 99    | 04    | ✓ |  |
| VAUXHALL | Astra Mk IV 1.8 16V Coupé        | 00    | 00    | ✓ |  |
| VAUXHALL | Astra Mk IV 2.0 16V, 2.0 DTI 16V | 98    | 04    | ✓ |  |
| VAUXHALL | Zafira                           | 99    | 04    | ✓ |  |

**202 065**

|          |                                     |    |    |   |  |
|----------|-------------------------------------|----|----|---|--|
| VAUXHALL | Cavalier 1.3, 1.6 NS, 1.6 SH        | 82 | 88 | ✓ |  |
| VAUXHALL | Cavalier 1.6 NZ, 1.6 SV, 1.6 Diesel | 82 | 88 | ✓ |  |
| VAUXHALL | Cavalier 1.7 Diesel, 1.8, 2.0       | 82 | 88 | ✓ |  |

**202 101**

|          |           |       |    |   |  |
|----------|-----------|-------|----|---|--|
| NISSAN   | Primaster | 01    | 03 | ✓ |  |
| OPEL     | Vivaro    | 01    | 03 | ✓ |  |
| RENAULT  | Trafic II | 03/01 | 05 | ✓ |  |
| VAUXHALL | Vivaro    | 01    | 05 | ✓ |  |

**202 140**

|          |                                       |       |    |   |  |
|----------|---------------------------------------|-------|----|---|--|
| OPEL     | Astra F 1.4, 1.6, 1.8, 2.0            | 92    | 98 | ✓ |  |
| OPEL     | Astra F 1.7 D, 1.7 TD, 1.7 TDS        | 92    | 98 | ✓ |  |
| OPEL     | Astra G 1.2 16V                       | 98    | 00 | ✓ |  |
| OPEL     | Astra G 1.4 16V                       | 98    | 04 | ✓ |  |
| OPEL     | Astra G 1.6                           | 98    | 00 | ✓ |  |
| OPEL     | Astra G 1.6 16V                       | 98    | 04 | ✓ |  |
| OPEL     | Astra G 1.7 TD                        | 98    | 00 | ✓ |  |
| OPEL     | Astra G 1.7 DTI 16V                   | 00    | 04 | ✓ |  |
| OPEL     | Astra G 1.8 16V                       | 98    | 00 | ✓ |  |
| OPEL     | Astra G 2.0 DI                        | 98    | 04 | ✓ |  |
| OPEL     | Astra Classic                         | 99    | 02 | ✓ |  |
| OPEL     | Corsa C Combo                         | 10/00 | 04 | ✓ |  |
| OPEL     | Meriva 1.4 16V Twinport               | 04    | 05 | ✓ |  |
| OPEL     | Meriva 1.3 CDTI, 1.6, 1.6 16V         | 03    | 05 | ✓ |  |
| OPEL     | Meriva 1.7 DTI, 1.8                   | 03    | 05 | ✓ |  |
| OPEL     | Vectra A 1.4, 1.6, 1.6 Automatic      | 93    | 93 | ✓ |  |
| OPEL     | Vectra A 1.6                          | 94    | 95 | ✓ |  |
| OPEL     | Vectra A 1.7 D, 1.7 TD, 1.8, 2.0      | 93    | 95 | ✓ |  |
| VAUXHALL | Astra Mk III 1.4, 1.6, 1.8, 2.0       | 92    | 98 | ✓ |  |
| VAUXHALL | Astra Mk III 1.7 Diesel, 1.7 Turbo D. | 92    | 98 | ✓ |  |
| VAUXHALL | Astra Mk IV 1.2 16V, 1.6, 1.7 TD      | 98    | 00 | ✓ |  |
| VAUXHALL | Astra Mk IV 1.4 16V, 1.6 16V          | 98    | 04 | ✓ |  |
| VAUXHALL | Astra Mk IV 1.7 DTI 16V               | 00    | 04 | ✓ |  |
| VAUXHALL | Astra Mk IV 1.8 16V                   | 98    | 00 | ✓ |  |
| VAUXHALL | Astra Mk IV 2.0 DI 16V                | 98    | 04 | ✓ |  |
| VAUXHALL | Astra Classic                         | 99    | 02 | ✓ |  |
| VAUXHALL | Corsa Mk II Combo                     | 10/00 | 05 | ✓ |  |
| VAUXHALL | Meriva 1.4 16V Twinport               | 04    | 05 | ✓ |  |
| VAUXHALL | Meriva 1.3 CDTI, 1.6, 1.6 16V         | 03    | 05 | ✓ |  |
| VAUXHALL | Meriva 1.7 DTI, 1.8                   | 03    | 05 | ✓ |  |

**202 142**

|      |                                  |       |    |   |  |
|------|----------------------------------|-------|----|---|--|
| OPEL | Astra F 1.4, 1.6, 1.8, 2.0       | 92    | 98 | ✓ |  |
| OPEL | Astra F 1.7 D, 1.7 TD, 1.7 TDS   | 92    | 98 | ✓ |  |
| OPEL | Astra G 1.2 16V, 1.6, 1.7 TD     | 98    | 00 | ✓ |  |
| OPEL | Astra G 1.4 16V, 1.6 16V         | 98    | 04 | ✓ |  |
| OPEL | Astra G 1.7 DTI 16V              | 00    | 04 | ✓ |  |
| OPEL | Astra Classic                    | 99    | 02 | ✓ |  |
| OPEL | Corsa C Combo                    | 10/00 | 04 | ✓ |  |
| OPEL | Meriva 1.4 16V Twinport          | 04    | 05 | ✓ |  |
| OPEL | Meriva 1.3 CDTI, 1.6, 1.6 16V    | 03    | 05 | ✓ |  |
| OPEL | Meriva 1.7 DTI, 1.8              | 03    | 05 | ✓ |  |
| OPEL | Vectra A 1.4, 1.6, 1.6 Automatic | 93    | 93 | ✓ |  |
| OPEL | Vectra A 1.6                     | 94    | 95 | ✓ |  |



**202 142**



|          |                                       |       |    |   |
|----------|---------------------------------------|-------|----|---|
| OPEL     | Vectra A 1.7 D, 1.7 TD, 1.8, 2.0      | 93    | 95 | ✓ |
| OPEL     | Vectra B 1.6 i, 1.6 i 16V, 1.7 TD     | 95    | 98 | ✓ |
| OPEL     | Vectra B 1.8 i 16V, 2.0 i             | 95    | 98 | ✓ |
| OPEL     | Vectra B 2.0 DI 16V                   | 96    | 98 | ✓ |
| OPEL     | Vectra B 2.0 DTI 16V                  | 97    | 98 | ✓ |
| VAUXHALL | Astra Mk III 1.4, 1.6, 1.8, 2.0       | 92    | 98 | ✓ |
| VAUXHALL | Astra Mk III 1.7 Diesel, 1.7 Turbo D. | 92    | 98 | ✓ |
| VAUXHALL | Astra Mk IV 1.2 16V, 1.6, 1.7 TD      | 98    | 00 | ✓ |
| VAUXHALL | Astra Mk IV 1.4 16V, 1.4 16V          | 98    | 04 | ✓ |
| VAUXHALL | Astra Mk IV 1.7 DTI 16V               | 00    | 04 | ✓ |
| VAUXHALL | Astra Classic                         | 99    | 02 | ✓ |
| VAUXHALL | Corsa Mk II Combo                     | 10/00 | 05 | ✓ |
| VAUXHALL | Meriva 1.3 CDTI                       | 03    | 05 | ✓ |
| VAUXHALL | Meriva 1.4 16V Twinport               | 04    | 05 | ✓ |
| VAUXHALL | Meriva 1.6, 1.6 16V                   | 03    | 05 | ✓ |
| VAUXHALL | Meriva 1.7 DTI                        | 03    | 05 | ✓ |
| VAUXHALL | Meriva 1.8                            | 03    | 05 | ✓ |
| VAUXHALL | Vectra Mk I 1.6, 1.7 TD, 1.8 16V, 2.0 | 96    | 98 | ✓ |
| VAUXHALL | Vectra Mk I 2.0 DI 16V, 2.0 DTI 16V   | 96    | 98 | ✓ |

**202 153**



|      |   |    |    |   |
|------|---|----|----|---|
| OPEL | Frontera A 2.0i Catalytic, 2.3 TD, 2.4i | 92 | 98 | ✓ |
|------|---|----|----|---|

**202 155**



|          |                              |    |    |   |
|----------|------------------------------|----|----|---|
| OPEL     | Frontera A 2.0i Ecotec, 2.2i | 92 | 98 | ✓ |
| OPEL     | Frontera A 2.5 TDS, 2.8 TD   | 92 | 98 | ✓ |
| OPEL     | Frontera B                   | 99 | 04 | ✓ |
| VAUXHALL | Frontera                     | 91 | 04 | ✓ |

**202 168**



|          |                                      |    |       |   |
|----------|--------------------------------------|----|-------|---|
| OPEL     | Calibra C20NE, X20XE, C20XE          | 89 | 97    | ✓ |
| OPEL     | Calibra C20LET                       | 89 | 97    | ✓ |
| OPEL     | Calibra C25XE, X25XE                 | 93 | 97    | ✓ |
| OPEL     | Omega A 2.3 Turbo Diesel             | 87 | 93    | ✓ |
| OPEL     | Omega A 2.4                          | 87 | 93    | ✓ |
| OPEL     | Omega A 2.6                          | 87 | 93    | ✓ |
| OPEL     | Omega A 3.0                          | 87 | 93    | ✓ |
| OPEL     | Omega A 3.6 24V Lotus                | 90 | 93    | ✓ |
| OPEL     | Omega A Caravan                      | 87 | 93    | ✓ |
| OPEL     | Omega B Caravan                      | 94 | 07/03 | ✓ |
| OPEL     | Senator B                            | 88 | 93    | ✓ |
| OPEL     | Vectra A 2.0 4x4                     | 89 | 92    | ✓ |
| OPEL     | Vectra A 2.0 4x4                     | 93 | 95    | ✓ |
| OPEL     | Vectra A 2.5 6V 4x4                  | 93 | 95    | ✓ |
| VAUXHALL | Calibra C20NE, C20XE                 | 89 | 97    | ✓ |
| VAUXHALL | Calibra X20XE, C20LET                | 89 | 97    | ✓ |
| VAUXHALL | Calibra C25XE, X25XE                 | 93 | 97    | ✓ |
| VAUXHALL | Carlton 1.8, 2.0, 2.4, 2.6, 3.0      | 87 | 93    | ✓ |
| VAUXHALL | Carlton 2.3 Diesel, 2.3 Turbo Diesel | 87 | 93    | ✓ |
| VAUXHALL | Carlton 3.6 24V Lotus                | 90 | 93    | ✓ |
| VAUXHALL | Cavalier 2.0 XE 16V                  | 92 | 95    | ✓ |
| VAUXHALL | Cavalier 2.0i Turbo 4x4              | 92 | 92    | ✓ |
| VAUXHALL | Cavalier 2.0i Turbo 4x4              | 93 | 94    | ✓ |
| VAUXHALL | Cavalier 2.5 XE V6 4x4               | 95 | 95    | ✓ |
| VAUXHALL | Omega Caravan                        | 94 | 03    | ✓ |
| VAUXHALL | Senator 2.5i, 3.0i                   | 88 | 93    | ✓ |

**202 202**



|          |                        |    |    |   |
|----------|------------------------|----|----|---|
| OPEL     | Rekord D               | 72 | 77 | ✓ |
| OPEL     | Rekord E 1.7           | 78 | 82 | ✓ |
| OPEL     | Rekord E 1.8           | 83 | 86 | ✓ |
| OPEL     | Rekord E 1.9           | 78 | 82 | ✓ |
| OPEL     | Rekord E 2.0           | 78 | 86 | ✓ |
| OPEL     | Rekord E 2.0 E Berlina | 78 | 84 | ✓ |
| VAUXHALL | Carlton                | 79 | 86 | ✓ |

**202 204**



|      |                  |    |    |   |
|------|------------------|----|----|---|
| OPEL | Commodore C      | 78 | 82 | ✓ |
| OPEL | Rekord D Caravan | 72 | 77 | ✓ |

**202 204**



|          |                                   |    |    |   |
|----------|-----------------------------------|----|----|---|
| OPEL     | Rekord E 1.7 Caravan, 1.9 Caravan | 78 | 82 | ✓ |
| OPEL     | Rekord E 1.8 Caravan              | 83 | 86 | ✓ |
| OPEL     | Rekord E 2.0 Diesel               | 78 | 82 | ✓ |
| OPEL     | Rekord E 2.1 Diesel               | 78 | 79 | ✓ |
| OPEL     | Rekord E 2.2 E Berlina            | 85 | 86 | ✓ |
| OPEL     | Rekord E 2.2 Turbo Diesel         | 85 | 86 | ✓ |
| OPEL     | Rekord E 2.3 Diesel               | 79 | 86 | ✓ |
| VAUXHALL | Carlton Diesel                    | 79 | 86 | ✓ |
| VAUXHALL | Viceroy                           | 80 | 82 | ✓ |

**202 205**



|      |           |       |    |    |   |
|------|-----------|-------|----|----|---|
| OPEL | Campo 4x4 | (TFR) | 91 | 00 | ✓ |
|------|-----------|-------|----|----|---|

**202 218**



|          |                                      |       |       |   |
|----------|--------------------------------------|-------|-------|---|
| OPEL     | Astra G 1.8 16V                      | 98    | 00    | ✓ |
| OPEL     | Astra G 1.8 16V Coupé                | 03/00 | 10/00 | ✓ |
| OPEL     | Astra G 2.0 16V, 2.0 DI, 2.0 DTI 16V | 98    | 04    | ✓ |
| OPEL     | Astra G 2.2 16V, 2.2 DTI             | 00    | 04    | ✓ |
| OPEL     | Meriva 1.7 CDTI                      | 03    | 05    | ✓ |
| OPEL     | Vectra A 2.5 6V                      | 93    | 95    | ✓ |
| OPEL     | Vectra B 2.0 i 16V, 2.5 i V6         | 95    | 98    | ✓ |
| OPEL     | Vectra B                             | 99    | 02    | ✓ |
| OPEL     | Zafira                               | 99    | 04    | ✓ |
| SAAB     | 900                                  | 94    | 98    | ✓ |
| SAAB     | 9-3                                  | 98    | 09/02 | ✓ |
| SAAB     | 9-5                                  | 98    | 04    | ✓ |
| VAUXHALL | Astra Mk IV 1.8 16V                  | 98    | 00    | ✓ |
| VAUXHALL | Astra Mk IV 1.8 16V Coupé            | 00    | 00    | ✓ |
| VAUXHALL | Astra Mk IV 2.0 16V, 2.0 DI 16V      | 98    | 04    | ✓ |
| VAUXHALL | Astra Mk IV 2.0 DTI 16V              | 98    | 04    | ✓ |
| VAUXHALL | Cavalier 2.5 XE V6                   | 93    | 95    | ✓ |
| VAUXHALL | Meriva 1.7 CDTI                      | 03    | 05    | ✓ |
| VAUXHALL | Vectra Mk I 2.0 16V, 2.5i V6         | 96    | 98    | ✓ |
| VAUXHALL | Vectra Mk I                          | 99    | 03/02 | ✓ |
| VAUXHALL | Zafira                               | 99    | 04    | ✓ |

**202 224**



|          |               |      |       |    |   |
|----------|---------------|------|-------|----|---|
| OPEL     | Agila         | 00   | 04    | ✓  |   |
| SUZUKI   | Wagon R+ 1.3i | (MM) | 05/00 | 04 | ✓ |
| VAUXHALL | Agila         | 00   | 04    | ✓  |   |

**202 226**



|          |           |    |    |   |
|----------|-----------|----|----|---|
| OPEL     | Monza     | 78 | 87 | ✓ |
| OPEL     | Senator A | 78 | 87 | ✓ |
| VAUXHALL | Royal     | 79 | 82 | ✓ |

**202 236**



|          |                                     |    |    |   |
|----------|-------------------------------------|----|----|---|
| OPEL     | Ascona B 1.3S, 1.6N Automatic       | 76 | 81 | ✓ |
| OPEL     | Ascona B 1.6S, 1.9, 2.0, 2.0 Diesel | 76 | 81 | ✓ |
| OPEL     | Kadett C 1.6, 1.9, 2.0              | 76 | 79 | ✓ |
| OPEL     | Manta B 1.3 S, 1.6 N Automatic      | 76 | 88 | ✓ |
| OPEL     | Manta B 1.6 S, 1.9, 2.0             | 76 | 88 | ✓ |
| VAUXHALL | Cavalier 1600, 1900                 | 76 | 81 | ✓ |

**202 519**



|          |                                     |       |       |   |
|----------|-------------------------------------|-------|-------|---|
| FIAT     | Croma (194) 1.8 16V                 | 12/05 | 12/06 | ✓ |
| FIAT     | Croma (194) 1.9 D Multijet, 2.2 16V | 06/05 | 12/06 | ✓ |
| FIAT     | Croma (194) 2.4 D Multijet          | 06/05 | 12/06 | ✓ |
| OPEL     | Signum                              | 03    | 06    | ✓ |
| OPEL     | Vectra C                            | 02    | 06    | ✓ |
| SAAB     | 9-3                                 | 09/02 | 06    | ✓ |
| VAUXHALL | Signum                              | 03    | 06    | ✓ |
| VAUXHALL | Vectra Mk II                        | 02    | 06    | ✓ |

**202 625**



|          |                 |       |    |   |
|----------|-----------------|-------|----|---|
| OPEL     | Astra H         | 03/04 | 06 | ✓ |
| OPEL     | Astra H TwinTop | 09/05 | 06 | ✓ |
| VAUXHALL | Astra Mk V      | 03/04 | 05 | ✓ |



**202 627**

|          |                 |       |    |  |   |
|----------|-----------------|-------|----|--|---|
| OPEL     | Astra H         | 03/04 | 06 |  | ✓ |
| OPEL     | Astra H TwinTop | 09/05 | 06 |  | ✓ |
| OPEL     | Zafira          | 07/05 | 06 |  | ✓ |
| VAUXHALL | Astra Mk V      | 03/04 | 05 |  | ✓ |

**202 673**

|          |        |    |    |  |   |
|----------|--------|----|----|--|---|
| OPEL     | Sintra | 96 | 99 |  | ✓ |
| VAUXHALL | Sintra | 96 | 99 |  | ✓ |

**300 004**

|      |  |       |       |    |   |
|------|--|-------|-------|----|---|
| FORD | Capri II 3000                          | 74    | 87    | ✓  |   |
| FORD | Escort III, IV 1.1, 1.3, 1.6           | 81    | 08/90 |    | ✓ |
| FORD | Escort III, IV 1.4, 1.8 Diesel         | 86    | 08/90 |    | ✓ |
| FORD | Escort III, IV 1.6 Diesel              | 81    | 90    |    | ✓ |
| FORD | Granada                                | 12/72 | 04/85 | ✓  |   |
| FORD | Orion 1.3, 1.6, 1.6 Diesel, 1.8 Diesel | 83    | 08/90 |    | ✓ |
| FORD | Orion 1.4                              | 86    | 08/90 |    | ✓ |
| FORD | P-100                                  | CP    | 04/82 | 87 | ✓ |

**300 052**

|      |                         |    |       |  |   |
|------|-------------------------|----|-------|--|---|
| FORD | Fiesta I, II 1.0, 1.1   | 77 | 03/89 |  | ✓ |
| FORD | Fiesta I, II 1.3        | 78 | 03/89 |  | ✓ |
| FORD | Fiesta I, II 1.4        | 86 | 03/89 |  | ✓ |
| FORD | Fiesta I, II 1.6 XR2    | 81 | 03/89 |  | ✓ |
| FORD | Fiesta I, II 1.6 Diesel | 84 | 03/89 |  | ✓ |

**300 062**

|      |                                       |       |       |   |   |
|------|---------------------------------------|-------|-------|---|---|
| FORD | Escort III, IV 1.1, 1.3, 1.6          | 81    | 08/90 |   | ✓ |
| FORD | Escort III, IV 1.4, 1.8 Diesel        | 86    | 08/90 |   | ✓ |
| FORD | Escort III, IV 1.6 Diesel, 1.7 Diesel | 81    | 90    |   | ✓ |
| FORD | Transit I FT 80-120                   | 78    | 91    | ✓ |   |
| FORD | Transit I FT 100 L                    | 78    | 91    | ✓ |   |
| FORD | Transit I FT 120-190                  | 78    | 10/85 | ✓ |   |
| FORD | Transit I FT 130-190                  | 11/85 | 91    | ✓ |   |

**301 006**

|      |  |    |       |   |  |
|------|--|----|-------|---|--|
| FORD | Escort III, IV 1.1, 1.6                | 81 | 08/90 | ✓ |  |
| FORD | Escort III, IV 1.3                     | 81 | 85    | ✓ |  |
| FORD | Escort III, IV 1.4                     | 86 | 08/90 | ✓ |  |
| FORD | Escort III, IV 1.6 Diesel, 1.7 Diesel  | 81 | 90    | ✓ |  |
| FORD | Escort III, IV 1.8 Diesel              | 86 | 08/90 | ✓ |  |
| FORD | Fiesta I, II 1.3, 1.6 XR2              | 81 | 03/89 | ✓ |  |
| FORD | Fiesta I, II 1.4                       | 86 | 03/89 | ✓ |  |
| FORD | Fiesta I, II 1.6 Diesel                | 84 | 03/89 | ✓ |  |
| FORD | Orion 1.4                              | 86 | 08/90 | ✓ |  |
| FORD | Orion 1.3, 1.6, 1.6 Diesel, 1.8 Diesel | 83 | 08/90 | ✓ |  |

**301 018**

|      |                       |    |       |   |  |
|------|-----------------------|----|-------|---|--|
| FORD | Escort III, IV 1.1    | 81 | 08/90 | ✓ |  |
| FORD | Escort III, IV 1.3    | 86 | 08/90 | ✓ |  |
| FORD | Fiesta I, II 1.0, 1.1 | 81 | 03/89 | ✓ |  |

**301 034**

|      |                             |       |    |    |   |
|------|-----------------------------|-------|----|----|---|
| FORD | Sierra 1.3, 2.0, 2.3        | 08/82 | 86 | ✓  |   |
| FORD | Sierra 1.6, 2.3 Diesel, 2.8 | 08/82 | 93 | ✓  |   |
| FORD | Sierra 1.8, 2.9             | 87    | 93 | ✓  |   |
| FORD | P-100                       | DP    | 88 | 92 | ✓ |

**301 038**

|      |                                  |       |    |    |   |
|------|----------------------------------|-------|----|----|---|
| FORD | Sierra 1.3, 2.3                  | 01/83 | 86 | ✓  |   |
| FORD | Sierra 1.6, 2.0, 2.3 Diesel, 2.8 | 01/83 | 93 | ✓  |   |
| FORD | Sierra 1.8, 2.9                  | 87    | 93 | ✓  |   |
| FORD | P-100                            | DP    | 88 | 92 | ✓ |

**301 039**

|      |                            |       |       |   |  |
|------|----------------------------|-------|-------|---|--|
| FORD | Fiesta V 1.3, 1.4 16V      | 10/01 | 05    | ✓ |  |
| FORD | Fiesta V 1.4 TDCi, 1.6 16V | 10/01 | 05    | ✓ |  |
| FORD | Focus I                    | 08/98 | 10/04 | ✓ |  |
| FORD | Fusion                     | 02    | 06    | ✓ |  |

**301 045**

|      |                            |       |       |   |  |
|------|----------------------------|-------|-------|---|--|
| FORD | Fiesta V 1.3, 1.4 16V      | 10/01 | 05    | ✓ |  |
| FORD | Fiesta V 1.4 TDCi, 1.6 16V | 10/01 | 05    | ✓ |  |
| FORD | Focus I                    | 08/98 | 10/04 | ✓ |  |
| FORD | Fusion                     | 02    | 06    | ✓ |  |

**301 118**

|      |                                 |    |       |   |  |
|------|---------------------------------|----|-------|---|--|
| FORD | Transit I FT 80-120, FT 130-150 | 92 | 07/00 | ✓ |  |
| FORD | Transit I FT 130-190, FT 190L   | 92 | 07/00 | ✓ |  |

**301 130**

|      |                                   |       |       |   |  |
|------|-----------------------------------|-------|-------|---|--|
| FORD | Escort V, VI, VII RS Cosworth 4x4 | 92    | 98    | ✓ |  |
| FORD | Granada 4x4                       | 10/85 | 10/94 | ✓ |  |
| FORD | Scorpio I 4x4                     | 10/85 | 09/94 | ✓ |  |
| FORD | Sierra RS Cosworth 4x4            | 02/90 | 93    | ✓ |  |
| FORD | Sierra XR 4x4                     | 03/85 | 93    | ✓ |  |

**301 132**

|      |                                     |       |       |   |  |
|------|-------------------------------------|-------|-------|---|--|
| FORD | Escort V, VI, VII 1.3               | 11/91 | 99    | ✓ |  |
| FORD | Escort V, VI, VII 1.4, 1.6          | 09/90 | 99    | ✓ |  |
| FORD | Escort V, VI, VII 1.6 4x4           | 95    | 98    | ✓ |  |
| FORD | Escort V, VI, VII 1.8, 1.8 Diesel   | 09/90 | 99    | ✓ |  |
| FORD | Escort V, VI, VII RS 2000           | 05/91 | 99    | ✓ |  |
| FORD | Escort V, VI, VII RS 2000 4x4       | 02/95 | 98    | ✓ |  |
| FORD | Fiesta III, IV                      | 02/94 | 01/02 | ✓ |  |
| FORD | Fiesta Courier                      | 02/94 | 09/02 | ✓ |  |
| FORD | Ka                                  | 09/96 | 05    | ✓ |  |
| FORD | Orion 1.3, 1.8 16V                  | 91    | 93    | ✓ |  |
| FORD | Orion 1.4, 1.6, 1.8 Diesel, 2.0 16V | 09/90 | 93    | ✓ |  |
| FORD | Puma                                | 06/97 | 04    | ✓ |  |
| FORD | Sport Ka                            | 05/03 | 05    | ✓ |  |
| FORD | Street Ka                           | 05/03 | 05    | ✓ |  |

**301 139**

|      |            |       |    |   |  |
|------|------------|-------|----|---|--|
| FORD | Scorpio II | 10/94 | 98 | ✓ |  |
|------|------------|-------|----|---|--|

**301 141**

|      |            |       |    |   |  |
|------|------------|-------|----|---|--|
| FORD | Scorpio II | 10/94 | 98 | ✓ |  |
|------|------------|-------|----|---|--|

**301 151**

|      |          |    |    |   |  |
|------|----------|----|----|---|--|
| FORD | Capri II | 74 | 87 | ✓ |  |
|------|----------|----|----|---|--|

**301 180**

|      |                                    |       |       |   |   |
|------|------------------------------------|-------|-------|---|---|
| FORD | Escort V, VI, VII 1.3, 1.4, 1.6    | 09/90 | 10/91 | ✓ |   |
| FORD | Escort V, VI, VII 1.6 4x4          | 95    | 98    | ✓ |   |
| FORD | Escort V, VI, VII 1.8 XR3i 16V 4x4 | 94    | 00    | ✓ | ✓ |
| FORD | Escort V, VI, VII RS 2000          | 05/91 | 10/91 | ✓ |   |
| FORD | Escort V, VI, VII RS 2000 4x4      | 94    | 01/95 | ✓ |   |
| FORD | Escort V, VI, VII RS 2000 4x4      | 94    | 98    | ✓ |   |
| FORD | Fiesta III                         | 04/89 | 01/94 | ✓ |   |
| FORD | Fiesta Courier                     | 91    | 01/94 | ✓ |   |
| FORD | Orion 1.3, 1.4, 1.6                | 09/90 | 12/90 | ✓ |   |

**301 182**

|      |            |       |       |   |  |
|------|------------|-------|-------|---|--|
| FORD | Cougar     | 08/98 | 01    | ✓ |  |
| FORD | Mondeo     | 93    | 11/00 | ✓ |  |
| FORD | Mondeo 4x4 | 93    | 96    | ✓ |  |

**301 183**

|        |   |       |       |   |  |
|--------|---|-------|-------|---|--|
| FORD   | Mondeo III 1.8 Sci                      | 06/03 | 06    | ✓ |  |
| FORD   | Mondeo III 1.8 16V, 2.0 16V, 2.0 16V DI | 11/00 | 06    | ✓ |  |
| FORD   | Mondeo III 2.0 16V TDDi, 2.5 V6 16V     | 11/00 | 06    | ✓ |  |
| FORD   | Mondeo III 2.0 TDCi                     | 10/01 | 06    | ✓ |  |
| FORD   | Mondeo III 2.2 TDCi, 3.0 V6 24V         | 09/04 | 06    | ✓ |  |
| FORD   | Mondeo III 3.0 V6 24V ST220             | 02    | 06    | ✓ |  |
| JAGUAR | X-Type 2.0 V6 24V                       | 03/02 | 05    | ✓ |  |
| JAGUAR | X-Type 2.0 Diesel                       | 07/03 | 10/05 | ✓ |  |
| JAGUAR | X-Type 2.2 Diesel                       | 10/05 | 12/05 | ✓ |  |
| JAGUAR | X-Type 2.5 V6 24V, 3.0 V6 24V 4x4       | 06/01 | 05    | ✓ |  |



**301 185**

|      |            |          |    |       |   |  |
|------|------------|----------|----|-------|---|--|
| FORD | Transit II | FWD, RWD | 00 | 06/06 | ✓ |  |
|------|------------|----------|----|-------|---|--|

**301 198**

|      |           |  |       |       |   |  |
|------|-----------|--|-------|-------|---|--|
| FORD | Granada   |  | 08/92 | 09/94 | ✓ |  |
| FORD | Scorpio I |  | 08/92 | 09/94 | ✓ |  |

**301 200**

|      |           |  |       |       |   |  |
|------|-----------|--|-------|-------|---|--|
| FORD | Granada   |  | 08/92 | 09/94 | ✓ |  |
| FORD | Scorpio I |  | 08/92 | 09/94 | ✓ |  |

**301 230**

|      |                       |  |    |    |   |  |
|------|-----------------------|--|----|----|---|--|
| FORD | Fiesta I, II 1.0, 1.1 |  | 77 | 80 | ✓ |  |
|------|-----------------------|--|----|----|---|--|

**301 232**

|      |                  |  |    |    |   |  |
|------|------------------|--|----|----|---|--|
| FORD | Fiesta I, II 1.3 |  | 78 | 80 | ✓ |  |
|------|------------------|--|----|----|---|--|

**301 244**

|      |                    |  |       |       |   |  |
|------|--------------------|--|-------|-------|---|--|
| FORD | Granada            |  | 05/85 | 07/92 | ✓ |  |
| FORD | Scorpio I          |  | 05/85 | 07/92 | ✓ |  |
| FORD | Sierra RS Cosworth |  | 86    | 01/90 | ✓ |  |

**301 246**

|      |                    |  |       |       |   |  |
|------|--------------------|--|-------|-------|---|--|
| FORD | Granada            |  | 05/85 | 07/92 | ✓ |  |
| FORD | Scorpio I          |  | 05/85 | 07/92 | ✓ |  |
| FORD | Sierra RS Cosworth |  | 86    | 01/90 | ✓ |  |

**301 280**

|      |                                |  |       |    |   |  |
|------|--------------------------------|--|-------|----|---|--|
| FORD | Cortina 1300, 1600, 2000, 2300 |  | 08/70 | 82 | ✓ |  |
| FORD | Escort                         |  | 12/74 | 80 | ✓ |  |
| FORD | Taurus 1.3, 1.6, 2.0, 2.3      |  | 70    | 82 | ✓ |  |

**301 511**

|      |                                     |  |       |    |   |  |
|------|-------------------------------------|--|-------|----|---|--|
| FORD | Mondeo III 2.0 16V DI, 2.0 16V TDDi |  | 11/00 | 06 | ✓ |  |
| FORD | Mondeo III 2.0 TDCi                 |  | 10/01 | 06 | ✓ |  |
| FORD | Mondeo III 2.5 V6 24V               |  | 11/00 | 06 | ✓ |  |

**301 583**

|      |         |       |       |       |   |  |
|------|---------|-------|-------|-------|---|--|
| FORD | Transit | Front | 07/06 | 12/06 | ✓ |  |
|------|---------|-------|-------|-------|---|--|

**301 585**

|      |         |       |       |       |   |  |
|------|---------|-------|-------|-------|---|--|
| FORD | Transit | Front | 07/06 | 12/06 | ✓ |  |
|------|---------|-------|-------|-------|---|--|

**301 667**

|       |                      |  |       |       |   |  |
|-------|----------------------|--|-------|-------|---|--|
| FORD  | Focus II             |  | 11/04 | 06    | ✓ |  |
| FORD  | Focus C-MAX          |  | 10/03 | 06    | ✓ |  |
| VOLVO | S 40 II, S 40 II ADW |  | 01/04 | 12/06 | ✓ |  |
| VOLVO | V 50                 |  | 04/04 | 12/06 | ✓ |  |
| VOLVO | C 70 cabriolet       |  | 03/06 | 12/06 | ✓ |  |

**302 037**

|      |        |  |    |       |   |  |
|------|--------|--|----|-------|---|--|
| FORD | Mondeo |  | 98 | 11/00 | ✓ |  |
|------|--------|--|----|-------|---|--|

**302 046**

|      |                                |  |       |       |   |  |
|------|--------------------------------|--|-------|-------|---|--|
| FORD | Sierra 1.3, 1.6, 2.0, 2.3, 2.8 |  | 08/82 | 08/83 | ✓ |  |
| FORD | Sierra 2.3 Diesel              |  | 08/82 | 08/83 | ✓ |  |

**302 057**

|      |                            |  |       |       |   |  |
|------|----------------------------|--|-------|-------|---|--|
| FORD | Fiesta V 1.3, 1.4 16V      |  | 10/01 | 05    | ✓ |  |
| FORD | Fiesta V 1.4 TDCi, 1.6 16V |  | 10/01 | 05    | ✓ |  |
| FORD | Focus I                    |  | 08/98 | 10/04 | ✓ |  |
| FORD | Fusion                     |  | 02    | 06    | ✓ |  |

**302 058**

|      |  |  |       |       |   |  |
|------|--|--|-------|-------|---|--|
| FORD | Escort V, VI, VII 1.3, 1.4, 1.6, 1.8, 1.8D |  | 09/90 | 99    | ✓ |  |
| FORD | Escort V, VI, VII RS 2000                  |  | 05/91 | 99    | ✓ |  |
| FORD | Fiesta III                                 |  | 04/89 | 01/94 | ✓ |  |
| FORD | Fiesta III, IV                             |  | 02/94 | 01/02 | ✓ |  |
| FORD | Ka   |  | 09/96 | 05    | ✓ |  |
| FORD | Orion 1.3, 1.4, 1.6, 1.8 Diesel, 2.0 16V   |  | 09/90 | 93    | ✓ |  |
| FORD | Orion 1.8 16V                              |  | 91    | 93    | ✓ |  |
| FORD | Puma                                       |  | 06/97 | 04    | ✓ |  |

**302 058**

|      |                     |  |       |    |   |  |
|------|---------------------|--|-------|----|---|--|
| FORD | Ka Sport, Ka Street |  | 05/03 | 05 | ✓ |  |
|------|---------------------|--|-------|----|---|--|

**302 067**

|      |            |  |       |    |   |  |
|------|------------|--|-------|----|---|--|
| FORD | Scorpio II |  | 05/97 | 98 | ✓ |  |
|------|------------|--|-------|----|---|--|

**302 074**

|      |                             |  |       |    |   |  |
|------|-----------------------------|--|-------|----|---|--|
| FORD | Sierra 1.3, 2.3, 2.8        |  | 09/83 | 86 | ✓ |  |
| FORD | Sierra 1.6, 2.0, 2.3 Diesel |  | 09/83 | 93 | ✓ |  |
| FORD | Sierra 1.8                  |  | 87    | 93 | ✓ |  |

**302 076**

|      |                             |  |       |    |   |  |
|------|-----------------------------|--|-------|----|---|--|
| FORD | Sierra 1.3, 2.3, 2.8        |  | 09/83 | 86 | ✓ |  |
| FORD | Sierra 1.6, 2.0, 2.3 Diesel |  | 09/83 | 93 | ✓ |  |
| FORD | Sierra 1.8                  |  | 87    | 93 | ✓ |  |

**302 120**

|      |                                   |  |       |       |   |  |
|------|-----------------------------------|--|-------|-------|---|--|
| FORD | Escort V, VI, VII RS Cosworth 4x4 |  | 92    | 98    | ✓ |  |
| FORD | Granada                           |  | 05/85 | 09/94 | ✓ |  |
| FORD | Granada 4x4                       |  | 10/85 | 10/94 | ✓ |  |
| FORD | Scorpio I                         |  | 05/85 | 07/92 | ✓ |  |
| FORD | Scorpio I                         |  | 08/92 | 09/94 | ✓ |  |
| FORD | Scorpio I 4x4                     |  | 10/85 | 09/94 | ✓ |  |
| FORD | Scorpio II                        |  | 10/94 | 04/97 | ✓ |  |
| FORD | Sierra 1.6, 1.8, 2.0, 2.3 Diesel  |  | 87    | 93    | ✓ |  |
| FORD | Sierra 2.8, 2.9                   |  | 87    | 93    | ✓ |  |
| FORD | Sierra RS Cosworth                |  | 86    | 01/90 | ✓ |  |
| FORD | Sierra RS Cosworth 4x4            |  | 02/90 | 93    | ✓ |  |
| FORD | Sierra XR 4x4                     |  | 03/85 | 93    | ✓ |  |

**302 122**

|      |  |  |       |       |   |  |
|------|--|--|-------|-------|---|--|
| FORD | Escort V, VI, VII RS Cosworth 4x4          |  | 92    | 98    | ✓ |  |
| FORD | Granada                                    |  | 05/85 | 09/94 | ✓ |  |
| FORD | Granada 4x4                                |  | 10/85 | 10/94 | ✓ |  |
| FORD | Scorpio I                                  |  | 05/85 | 09/94 | ✓ |  |
| FORD | Scorpio I 4x4                              |  | 10/85 | 09/94 | ✓ |  |
| FORD | Scorpio II                                 |  | 10/94 | 04/97 | ✓ |  |
| FORD | Sierra 1.6, 1.8, 2.0, 2.3 Diesel, 2.8, 2.9 |  | 87    | 93    | ✓ |  |
| FORD | Sierra RS Cosworth                         |  | 86    | 01/90 | ✓ |  |
| FORD | Sierra RS Cosworth 4x4                     |  | 02/90 | 93    | ✓ |  |
| FORD | Sierra XR 4x4                              |  | 03/85 | 93    | ✓ |  |

**302 124**

|      |                      |     |       |       |   |  |
|------|----------------------|-----|-------|-------|---|--|
| FORD | Transit I FT 100 L   |     | 11/85 | 91    | ✓ |  |
| FORD | Transit I FT 130-190 |     | 11/85 | 07/00 | ✓ |  |
| FORD | Transit II           | RWD | 00    | 06/06 | ✓ |  |

**302 146**

|      |                                |  |       |    |   |  |
|------|--------------------------------|--|-------|----|---|--|
| FORD | Cortina 1300, 1600, 2000, 2300 |  | 08/70 | 82 | ✓ |  |
| FORD | Taurus 1.3, 1.6, 2.0, 2.3      |  | 70    | 82 | ✓ |  |

**302 160**

|      |                     |  |    |       |   |  |
|------|---------------------|--|----|-------|---|--|
| FORD | Transit I FT 80-120 |  | 78 | 10/85 | ✓ |  |
|------|---------------------|--|----|-------|---|--|

**302 162**

|      |                      |  |    |       |   |  |
|------|----------------------|--|----|-------|---|--|
| FORD | Transit I FT 120-190 |  | 78 | 10/85 | ✓ |  |
|------|----------------------|--|----|-------|---|--|

**302 164**

|      |                     |  |    |       |   |  |
|------|---------------------|--|----|-------|---|--|
| FORD | Transit I FT 80-120 |  | 92 | 07/00 | ✓ |  |
|------|---------------------|--|----|-------|---|--|

**302 166**

|      |                                |  |    |       |   |  |
|------|--------------------------------|--|----|-------|---|--|
| FORD | Transit I FT 130-150, FT 190 L |  | 92 | 07/00 | ✓ |  |
|------|--------------------------------|--|----|-------|---|--|

**302 172**

|      |                               |  |    |       |   |  |
|------|-------------------------------|--|----|-------|---|--|
| FORD | Transit I FT 80-120, FT 100 L |  | 78 | 10/85 | ✓ |  |
|------|-------------------------------|--|----|-------|---|--|

**302 174**

|      |                     |  |       |    |   |  |
|------|---------------------|--|-------|----|---|--|
| FORD | Transit I FT 80-120 |  | 11/85 | 91 | ✓ |  |
|------|---------------------|--|-------|----|---|--|

**302 176**

|      |                     |  |       |    |   |  |
|------|---------------------|--|-------|----|---|--|
| FORD | Transit I FT 80-120 |  | 11/85 | 91 | ✓ |  |
|------|---------------------|--|-------|----|---|--|

**302 186**

|      |                |       |       |  |   |
|------|----------------|-------|-------|--|---|
| FORD | Cougar         | 08/98 | 01    |  | ✓ |
| FORD | Fiesta Courier | 95    | 09/02 |  | ✓ |
| FORD | Mondeo         | 93    | 11/00 |  | ✓ |

**302 188**

|      |                |       |       |  |   |
|------|----------------|-------|-------|--|---|
| FORD | Cougar         | 08/98 | 01    |  | ✓ |
| FORD | Fiesta Courier | 95    | 09/02 |  | ✓ |
| FORD | Mondeo         | 93    | 11/00 |  | ✓ |

**302 190**

|      |            |    |    |  |   |
|------|------------|----|----|--|---|
| FORD | Mondeo 4x4 | 93 | 96 |  | ✓ |
|------|------------|----|----|--|---|

**302 192**

|      |        |    |    |  |   |
|------|--------|----|----|--|---|
| FORD | Mondeo | 93 | 97 |  | ✓ |
|------|--------|----|----|--|---|

**302 196**

|      |            |    |    |  |   |
|------|------------|----|----|--|---|
| FORD | Mondeo 4x4 | 93 | 96 |  | ✓ |
|------|------------|----|----|--|---|

**302 197**

|        |                                     |       |       |  |   |
|--------|-------------------------------------|-------|-------|--|---|
| FORD   | Mondeo III 1.8 16V, 2.0 16V         | 11/00 | 06    |  | ✓ |
| FORD   | Mondeo III 1.8 Sci                  | 06/03 | 06    |  | ✓ |
| FORD   | Mondeo III 2.0 16V DI, 2.0 16V TDDi | 11/00 | 06    |  | ✓ |
| FORD   | Mondeo III 2.0 TDCi                 | 10/01 | 06    |  | ✓ |
| FORD   | Mondeo III 2.2 TDCi, 3.0 V6 24V     | 09/04 | 06    |  | ✓ |
| FORD   | Mondeo III 2.5 V6 24V               | 11/00 | 06    |  | ✓ |
| FORD   | Mondeo III 3.0 V6 24V ST220         | 02    | 06    |  | ✓ |
| JAGUAR | X-Type 2.0 V6 24V                   | 03/02 | 05    |  | ✓ |
| JAGUAR | X-Type 2.0 Diesel                   | 07/03 | 10/05 |  | ✓ |
| JAGUAR | X-Type 2.2 Diesel                   | 10/05 | 12/05 |  | ✓ |

**302 208**

|      |       |    |       |    |   |
|------|-------|----|-------|----|---|
| FORD | P-100 | CP | 04/82 | 87 | ✓ |
|------|-------|----|-------|----|---|

**302 234**

|      |         |       |       |  |   |
|------|---------|-------|-------|--|---|
| FORD | Granada | 12/72 | 04/85 |  | ✓ |
|------|---------|-------|-------|--|---|

**302 240**

|      |       |    |    |    |   |
|------|-------|----|----|----|---|
| FORD | P-100 | DP | 88 | 92 | ✓ |
|------|-------|----|----|----|---|

**302 248**

|      |  |       |    |  |   |
|------|--|-------|----|--|---|
| FORD | Escort V, VI, VII 1.3, 1.4, 1.6, 1.8, 1.8D | 09/90 | 99 |  | ✓ |
|------|--|-------|----|--|---|

**302 254**

|      |                         |       |    |  |   |
|------|-------------------------|-------|----|--|---|
| FORD | Capri II, Capri II 3000 | 74    | 87 |  | ✓ |
| FORD | Cortina 1300, 1600      | 08/70 | 82 |  | ✓ |
| FORD | Escort                  | 12/74 | 80 |  | ✓ |
| FORD | Taurus 1.3, 1.6         | 70    | 82 |  | ✓ |

**302 255**

|      |            |      |       |       |   |
|------|------------|------|-------|-------|---|
| FORD | Transit II | FWD  | 00    | 06/06 | ✓ |
| FORD | Transit    | Rear | 07/06 | 12/06 | ✓ |

**302 257**

|      |            |     |    |       |   |
|------|------------|-----|----|-------|---|
| FORD | Transit II | FWD | 00 | 06/06 | ✓ |
|------|------------|-----|----|-------|---|

**302 260**

|      |                |    |       |  |   |
|------|----------------|----|-------|--|---|
| FORD | Fiesta Courier | 91 | 12/94 |  | ✓ |
|------|----------------|----|-------|--|---|

**302 595**

|      |         |      |       |       |   |
|------|---------|------|-------|-------|---|
| FORD | Transit | Rear | 07/06 | 12/06 | ✓ |
|------|---------|------|-------|-------|---|

**302 597**

|      |         |      |       |       |   |
|------|---------|------|-------|-------|---|
| FORD | Transit | Rear | 07/06 | 12/06 | ✓ |
|------|---------|------|-------|-------|---|

**400 051**

|               |         |      |    |       |   |   |
|---------------|---------|------|----|-------|---|---|
| MERCEDES-BENZ | M-class | W163 | 98 | 06/05 | ✓ | ✓ |
|---------------|---------|------|----|-------|---|---|

**400 061**

|               |                     |      |       |       |   |  |
|---------------|---------------------|------|-------|-------|---|--|
| MERCEDES-BENZ | E-class 280 4-Matic | W210 | 96    | 03/02 | ✓ |  |
| MERCEDES-BENZ | E-class 280 4-Matic | T210 | 96    | 02    | ✓ |  |
| MERCEDES-BENZ | E-class 320 4-Matic | W210 | 06/97 | 03/02 | ✓ |  |
| MERCEDES-BENZ | E-class 320 4-Matic | T210 | 97    | 02    | ✓ |  |

**400 107**

|               |         |      |    |    |   |   |
|---------------|---------|------|----|----|---|---|
| MERCEDES-BENZ | V-class |      | 97 | 05 | ✓ | ✓ |
| MERCEDES-BENZ | Vito    | W638 | 96 | 04 | ✓ | ✓ |

**401 028**

|               |                          |      |    |    |   |  |
|---------------|--------------------------|------|----|----|---|--|
| MERCEDES-BENZ | 200, 200 D               | W123 | 76 | 85 | ✓ |  |
| MERCEDES-BENZ | 220 D, 230, 230 T        | 123  | 76 | 85 | ✓ |  |
| MERCEDES-BENZ | 240 D, 240 TD, 250, 250T | 123  | 76 | 85 | ✓ |  |
| MERCEDES-BENZ | 260 SE                   | W126 | 86 | 92 | ✓ |  |
| MERCEDES-BENZ | 280 S, 280 SE, 280 SEL   | W116 | 73 | 76 | ✓ |  |
| MERCEDES-BENZ | 280 C/CE Coupé           | 123  | 77 | 85 | ✓ |  |
| MERCEDES-BENZ | 280, 280 E, 280 TE       | 123  | 76 | 85 | ✓ |  |
| MERCEDES-BENZ | 280 S, 280 SE, 280 SEL   | W126 | 80 | 85 | ✓ |  |
| MERCEDES-BENZ | 300 D, 300 TD            | W123 | 76 | 85 | ✓ |  |
| MERCEDES-BENZ | 300 SE, 300 SEL          | W126 | 86 | 92 | ✓ |  |
| MERCEDES-BENZ | 350 SE, 350 SEL          | W116 | 75 | 80 | ✓ |  |
| MERCEDES-BENZ | 380 SE, 380 SEL          | W126 | 80 | 85 | ✓ |  |
| MERCEDES-BENZ | 380 SEC Coupé            | C126 | 82 | 85 | ✓ |  |
| MERCEDES-BENZ | 450 SE, 450 SEL          | W116 | 73 | 80 | ✓ |  |
| MERCEDES-BENZ | 450 SEL 6.9              | W116 | 75 | 80 | ✓ |  |
| MERCEDES-BENZ | 500 SE, 500 SEL          | W126 | 80 | 85 | ✓ |  |
| MERCEDES-BENZ | 500 SEC Coupé            | C126 | 82 | 85 | ✓ |  |
| MERCEDES-BENZ | 207 D                    |      | 78 | 90 | ✓ |  |
| MERCEDES-BENZ | 208                      |      | 78 | 82 | ✓ |  |
| MERCEDES-BENZ | 208 D                    |      | 90 | 94 | ✓ |  |
| MERCEDES-BENZ | 209 D                    |      | 84 | 90 | ✓ |  |
| MERCEDES-BENZ | 210                      |      | 83 | 94 | ✓ |  |
| MERCEDES-BENZ | 210 D                    |      | 89 | 94 | ✓ |  |
| MERCEDES-BENZ | 307 D                    |      | 78 | 90 | ✓ |  |
| MERCEDES-BENZ | 308                      |      | 78 | 82 | ✓ |  |
| MERCEDES-BENZ | 308 D                    |      | 90 | 94 | ✓ |  |
| MERCEDES-BENZ | 309 D                    |      | 83 | 90 | ✓ |  |
| MERCEDES-BENZ | 310                      |      | 83 | 94 | ✓ |  |
| MERCEDES-BENZ | 310 D                    |      | 89 | 94 | ✓ |  |

**401 042**

|               |                                |      |       |       |   |  |
|---------------|--------------------------------|------|-------|-------|---|--|
| MERCEDES-BENZ | 190 E 2.3 16V                  | W201 | 84    | 93    | ✓ |  |
| MERCEDES-BENZ | 190 E 2.5 16V                  | W201 | 88    | 93    | ✓ |  |
| MERCEDES-BENZ | 200                            | T124 | 86    | 93    | ✓ |  |
| MERCEDES-BENZ | 200                            | W124 | 85    | 93    | ✓ |  |
| MERCEDES-BENZ | 200 CE Cabriolet, 200 CE Coupé | C124 | 90    | 94    | ✓ |  |
| MERCEDES-BENZ | 220 E                          | W124 | 93    | 93    | ✓ |  |
| MERCEDES-BENZ | 220 TE                         | T124 | 93    | 94    | ✓ |  |
| MERCEDES-BENZ | 220 CE Cabriolet, 220 CE Coupé | C124 | 93    | 94    | ✓ |  |
| MERCEDES-BENZ | 230 CE Coupé                   | C124 | 87    | 94    | ✓ |  |
| MERCEDES-BENZ | 230 E                          | T124 | 86    | 93    | ✓ |  |
| MERCEDES-BENZ | 230 E                          | W124 | 85    | 93    | ✓ |  |
| MERCEDES-BENZ | 230 TE                         | T124 | 86    | 93    | ✓ |  |
| MERCEDES-BENZ | 250 D                          | T124 | 86    | 93    | ✓ |  |
| MERCEDES-BENZ | 250 D, 250 D Turbo Diesel      | W124 | 85    | 93    | ✓ |  |
| MERCEDES-BENZ | 250 TD                         | T124 | 89    | 93    | ✓ |  |
| MERCEDES-BENZ | 250 TD Turbo Diesel            | T124 | 86    | 93    | ✓ |  |
| MERCEDES-BENZ | 260 E                          | W124 | 85    | 93    | ✓ |  |
| MERCEDES-BENZ | 280 E                          | W124 | 93    | 93    | ✓ |  |
| MERCEDES-BENZ | 280 TE                         | T124 | 93    | 95    | ✓ |  |
| MERCEDES-BENZ | 300                            | C124 | 87    | 94    | ✓ |  |
| MERCEDES-BENZ | 300                            | T124 | 86    | 93    | ✓ |  |
| MERCEDES-BENZ | 300                            | W124 | 85    | 93    | ✓ |  |
| MERCEDES-BENZ | 300 SL                         | R107 | 85    | 88    | ✓ |  |
| MERCEDES-BENZ | 320 CE Coupé                   | C124 | 93    | 93    | ✓ |  |
| MERCEDES-BENZ | 320 E                          | W124 | 93    | 93    | ✓ |  |
| MERCEDES-BENZ | 320 TE                         | T124 | 93    | 94    | ✓ |  |
| MERCEDES-BENZ | 420 SL                         | R107 | 85    | 88    | ✓ |  |
| MERCEDES-BENZ | 500 SL                         | R107 | 85    | 88    | ✓ |  |
| MERCEDES-BENZ | E-class 200, 200 Diesel        | W124 | 06/93 | 06/95 | ✓ |  |
| MERCEDES-BENZ | E-class 200 Cabriolet, Coupé   | C124 | 93    | 02    | ✓ |  |
| MERCEDES-BENZ | E-class 220                    | W124 | 06/93 | 06/95 | ✓ |  |
| MERCEDES-BENZ | E-class 220 Cabriolet, Coupé   | C124 | 93    | 02    | ✓ |  |
| MERCEDES-BENZ | E-class 250 Diesel             | W124 | 07/93 | 06/95 | ✓ |  |

**401 042**

|               |                          |      |       |       |   |  |
|---------------|--------------------------|------|-------|-------|---|--|
| MERCEDES-BENZ | E-class 250 Diesel       | T124 | 06/93 | 06/96 | ✓ |  |
| MERCEDES-BENZ | E-class 250 Turbo Diesel | W124 | 06/93 | 06/95 | ✓ |  |
| MERCEDES-BENZ | E-class 250 Turbo Diesel | T124 | 94    | 06/96 | ✓ |  |
| MERCEDES-BENZ | E-class 280              | W124 | 06/93 | 06/95 | ✓ |  |
| MERCEDES-BENZ | E-class 300 Diesel       | W124 | 93    | 95    | ✓ |  |
| MERCEDES-BENZ | E-class 300 Diesel       | T124 | 06/93 | 06/96 | ✓ |  |
| MERCEDES-BENZ | E-class 300 Turbo Diesel | W124 | 93    | 95    | ✓ |  |
| MERCEDES-BENZ | E-class 300 Turbo Diesel | T124 | 93    | 06/96 | ✓ |  |
| MERCEDES-BENZ | E-class 320              | W124 | 06/93 | 06/95 | ✓ |  |
| MERCEDES-BENZ | E-class 320 Coupé        | C124 | 06/93 | 02    | ✓ |  |

**401 047**

|               |         |      |       |       |   |  |
|---------------|---------|------|-------|-------|---|--|
| MERCEDES-BENZ | A-class | W168 | 97    | 02/01 | ✓ |  |
| MERCEDES-BENZ | A-class | W168 | 02/01 | 08/04 | ✓ |  |
| MERCEDES-BENZ | Vaneo   |      | 01    | 05    | ✓ |  |

**401 048**

|               |                          |      |    |    |   |  |
|---------------|--------------------------|------|----|----|---|--|
| MERCEDES-BENZ | 190 E 1.8, 2.3, 2.5, 2.6 | W201 | 86 | 93 | ✓ |  |
|---------------|--------------------------|------|----|----|---|--|

**401 078**

|               |                              |      |       |       |   |  |
|---------------|------------------------------|------|-------|-------|---|--|
| MERCEDES-BENZ | 260 E                        | T124 | 86    | 93    | ✓ |  |
| MERCEDES-BENZ | 300 SL                       | R129 | 89    | 93    | ✓ |  |
| MERCEDES-BENZ | 400 E                        | W124 | 93    | 93    | ✓ |  |
| MERCEDES-BENZ | C-class                      | W202 | 93    | 03/01 | ✓ |  |
| MERCEDES-BENZ | C-class                      | T202 | 96    | 03/01 | ✓ |  |
| MERCEDES-BENZ | CLK-class                    | C208 | 97    | 04    | ✓ |  |
| MERCEDES-BENZ | CLK-class Cabriolet          | A208 | 98    | 04    | ✓ |  |
| MERCEDES-BENZ | CLK-class                    | C209 | 06/02 | 04    | ✓ |  |
| MERCEDES-BENZ | CLK-class Cabriolet          | A209 | 02/03 | 04    | ✓ |  |
| MERCEDES-BENZ | E-class 200 Diesel           | W210 | 94    | 03/02 | ✓ |  |
| MERCEDES-BENZ | E-class 200, 200 Kompressor  | W210 | 06/95 | 03/02 | ✓ |  |
| MERCEDES-BENZ | E-class 200, 200 Kompressor  | T210 | 96    | 02    | ✓ |  |
| MERCEDES-BENZ | E-class 220 Diesel, CDI      | W210 | 07/95 | 03/02 | ✓ |  |
| MERCEDES-BENZ | E-class 230                  | W210 | 96    | 03/02 | ✓ |  |
| MERCEDES-BENZ | E-class 240                  | W210 | 06/95 | 03/02 | ✓ |  |
| MERCEDES-BENZ | E-class 250 Diesel           | W210 | 07/95 | 03/02 | ✓ |  |
| MERCEDES-BENZ | E-class 230, 240, 250 Diesel | T210 | 96    | 02    | ✓ |  |
| MERCEDES-BENZ | E-class 250 Turbo Diesel     | W210 | 07/97 | 03/02 | ✓ |  |
| MERCEDES-BENZ | E-class 250 Turbo Diesel     | T210 | 96    | 02    | ✓ |  |
| MERCEDES-BENZ | E-class 280                  | W210 | 96    | 03/02 | ✓ |  |
| MERCEDES-BENZ | E-class 280                  | T210 | 96    | 02    | ✓ |  |
| MERCEDES-BENZ | E-class 290 Turbo Diesel     | W210 | 96    | 07/99 | ✓ |  |
| MERCEDES-BENZ | E-class 290 Turbo Diesel     | T210 | 96    | 07/99 | ✓ |  |
| MERCEDES-BENZ | E-class 300 Diesel           | W210 | 07/95 | 06/97 | ✓ |  |
| MERCEDES-BENZ | E-class 300 Turbo Diesel     | W210 | 96    | 07/99 | ✓ |  |
| MERCEDES-BENZ | E-class 300 Turbo Diesel     | T210 | 96    | 07/99 | ✓ |  |
| MERCEDES-BENZ | E-class 320                  | W210 | 06/95 | 03/02 | ✓ |  |
| MERCEDES-BENZ | E-class 320                  | T210 | 96    | 02    | ✓ |  |
| MERCEDES-BENZ | E-class 420                  | W124 | 06/93 | 06/95 | ✓ |  |
| MERCEDES-BENZ | E-class 420                  | W210 | 96    | 06/97 | ✓ |  |
| MERCEDES-BENZ | E-class 420                  | T210 | 96    | 02    | ✓ |  |
| MERCEDES-BENZ | E-class 430                  | W210 | 06/95 | 03/02 | ✓ |  |
| MERCEDES-BENZ | E-class 430                  | T210 | 96    | 02    | ✓ |  |
| MERCEDES-BENZ | E-class 500                  | W124 | 06/93 | 06/95 | ✓ |  |
| MERCEDES-BENZ | E-class 55 AMG               | W210 | 08/97 | 03/02 | ✓ |  |
| MERCEDES-BENZ | E-class 55 AMG               | T210 | 96    | 02    | ✓ |  |
| MERCEDES-BENZ | SLK-class                    | R170 | 96    | 04/04 | ✓ |  |

**401 082**

|               |                   |      |    |    |   |  |
|---------------|-------------------|------|----|----|---|--|
| MERCEDES-BENZ | 300, 400, 500     | W140 | 91 | 93 | ✓ |  |
| MERCEDES-BENZ | 500 SEC Coupé     | C140 | 92 | 93 | ✓ |  |
| MERCEDES-BENZ | 600 SE, 600 SEL   | W140 | 91 | 93 | ✓ |  |
| MERCEDES-BENZ | 600 SEC-V12 Coupé | C140 | 92 | 93 | ✓ |  |
| MERCEDES-BENZ | CL-class Coupé    | C140 | 97 | 03 | ✓ |  |
| MERCEDES-BENZ | S-class           | W140 | 94 | 98 | ✓ |  |
| MERCEDES-BENZ | S-class Coupé     | C140 | 92 | 99 | ✓ |  |

**401 083**

|               |         |      |    |    |   |  |
|---------------|---------|------|----|----|---|--|
| MERCEDES-BENZ | S-class | W220 | 98 | 04 | ✓ |  |
|---------------|---------|------|----|----|---|--|

**401 083**

|               |                   |      |    |    |   |  |
|---------------|-------------------|------|----|----|---|--|
| MERCEDES-BENZ | S-class Coupé     | C215 | 99 | 04 | ✓ |  |
| MERCEDES-BENZ | SL-class Roadster | R230 | 01 | 04 | ✓ |  |

**401 096**

|               |                                  |      |       |       |   |  |
|---------------|----------------------------------|------|-------|-------|---|--|
| MERCEDES-BENZ | 260 E 4-Matic, 300 4-Matic       | W124 | 87    | 93    | ✓ |  |
| MERCEDES-BENZ | 300 4-Matic                      | T124 | 87    | 93    | ✓ |  |
| MERCEDES-BENZ | E-class 300, 300 4-Matic         | W124 | 94    | 95    | ✓ |  |
| MERCEDES-BENZ | E-class 300 4-Matic              | T124 | 06/93 | 06/96 | ✓ |  |
| MERCEDES-BENZ | E-class 300 Turbo Diesel 4-Matic | W124 | 93    | 95    | ✓ |  |
| MERCEDES-BENZ | E-class 300 Turbo Diesel 4-Matic | T124 | 06/93 | 06/96 | ✓ |  |

**401 100**

|               |                                |  |    |    |   |  |
|---------------|--------------------------------|--|----|----|---|--|
| MERCEDES-BENZ | G-class 230 GE 4x4             |  | 82 | 82 | ✓ |  |
| MERCEDES-BENZ | G-class 230 G 4x4, 240 GD 4x4  |  | 79 | 82 | ✓ |  |
| MERCEDES-BENZ | G-class 280 GE 4x4, 300 GD 4x4 |  | 79 | 82 | ✓ |  |

**401 104**

|               |                    |  |    |    |   |  |
|---------------|--------------------|--|----|----|---|--|
| MERCEDES-BENZ | G-class 230 G 4x4  |  | 82 | 82 | ✓ |  |
| MERCEDES-BENZ | G-class 230 GE 4x4 |  | 82 | 93 | ✓ |  |
| MERCEDES-BENZ | G-class 240 GD 4x4 |  | 82 | 85 | ✓ |  |
| MERCEDES-BENZ | G-class 250 GD 4x4 |  | 87 | 93 | ✓ |  |
| MERCEDES-BENZ | G-class 280 GE 4x4 |  | 82 | 88 | ✓ |  |
| MERCEDES-BENZ | G-class 300 GD 4x4 |  | 82 | 93 | ✓ |  |

**401 126**

|               |                                  |       |    |    |   |  |
|---------------|----------------------------------|-------|----|----|---|--|
| MERCEDES-BENZ | 200, 200 D                       | W123  | 80 | 85 | ✓ |  |
| MERCEDES-BENZ | 220 D, 230, 230 T, 240 D, 240 TD | 123   | 80 | 85 | ✓ |  |
| MERCEDES-BENZ | 260 SE                           | W126  | 86 | 92 | ✓ |  |
| MERCEDES-BENZ | 250, 250 T, 280 C/CE Coupé       | 123   | 80 | 85 | ✓ |  |
| MERCEDES-BENZ | 280, 280 E, 280 TE               | 123   | 80 | 85 | ✓ |  |
| MERCEDES-BENZ | 300 D, 300 TD                    | W123  | 80 | 85 | ✓ |  |
| MERCEDES-BENZ | 300 SE, 300 SEL, 420 SE, 420 SEL |       | 86 | 92 | ✓ |  |
| MERCEDES-BENZ | 380 SE, 380 SEL                  | W 126 | 80 | 85 | ✓ |  |
| MERCEDES-BENZ | 500 SE, 500 SEL, 560 SE, 560 SEL |       | 86 | 92 | ✓ |  |
| MERCEDES-BENZ | 420 SEC Coupé, 500 SEC Coupé     | C126  | 86 | 92 | ✓ |  |
| MERCEDES-BENZ | 560 SEC Coupé                    | C126  | 86 | 92 | ✓ |  |

**401 137**

|               |                            |  |       |       |   |  |
|---------------|----------------------------|--|-------|-------|---|--|
| MERCEDES-BENZ | 307 D                      |  | 78    | 90    | ✓ |  |
| MERCEDES-BENZ | 308 D                      |  | 90    | 94    | ✓ |  |
| MERCEDES-BENZ | 309 D                      |  | 83    | 90    | ✓ |  |
| MERCEDES-BENZ | 310 D                      |  | 89    | 94    | ✓ |  |
| MERCEDES-BENZ | Sprinter 208 D, 212 D, 214 |  | 95    | 05/06 | ✓ |  |
| MERCEDES-BENZ | Sprinter 308 D, 312 D, 314 |  | 95    | 05/06 | ✓ |  |
| MERCEDES-BENZ | Sprinter 408 D, 412 D, 414 |  | 95    | 05/06 | ✓ |  |
| VOLKSWAGEN    | LT 28 II, LT 35 II         |  | 04/96 | 04    | ✓ |  |
| VOLKSWAGEN    | LT 46                      |  | 96    | 04    | ✓ |  |

**401 157**

|               |           |      |       |       |   |  |
|---------------|-----------|------|-------|-------|---|--|
| MERCEDES-BENZ | C-class   | W203 | 05/00 | 04    | ✓ |  |
| MERCEDES-BENZ | SLK-class | R171 | 03/04 | 12/06 | ✓ |  |

**401 165**

|               |                       |      |       |       |   |  |
|---------------|-----------------------|------|-------|-------|---|--|
| MERCEDES-BENZ | 230 E, 250 D          | T124 | 86    | 93    | ✓ |  |
| MERCEDES-BENZ | 230 TE                | T124 | 86    | 92    | ✓ |  |
| MERCEDES-BENZ | 250 D, 260 E          | W124 | 85    | 93    | ✓ |  |
| MERCEDES-BENZ | 280 E                 | W124 | 93    | 93    | ✓ |  |
| MERCEDES-BENZ | 280 E                 | T124 | 93    | 95    | ✓ |  |
| MERCEDES-BENZ | 280 TE                | T124 | 93    | 95    | ✓ |  |
| MERCEDES-BENZ | 300 Cabriolet         | C124 | 90    | 94    | ✓ |  |
| MERCEDES-BENZ | 300 SL-24             | R129 | 89    | 93    | ✓ |  |
| MERCEDES-BENZ | 320 E Cabriolet       | C124 | 93    | 93    | ✓ |  |
| MERCEDES-BENZ | 500 E                 | W124 | 90    | 93    | ✓ |  |
| MERCEDES-BENZ | 500 SL                | R129 | 89    | 93    | ✓ |  |
| MERCEDES-BENZ | 600 SL                | R129 | 89    | 93    | ✓ |  |
| MERCEDES-BENZ | E-class 250 Diesel    | W124 | 07/93 | 06/95 | ✓ |  |
| MERCEDES-BENZ | E-class 250 Diesel    | T124 | 06/93 | 06/96 | ✓ |  |
| MERCEDES-BENZ | E-class 280           | W124 | 06/93 | 06/95 | ✓ |  |
| MERCEDES-BENZ | E-class 320 Cabriolet | C124 | 94    | 02    | ✓ |  |

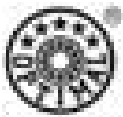

# OPTIMAL

## SATZ-VERZEICHNIS KITS INDEX INDEX DES KITS

### 401 165

|               |          |      |    |    |   |  |
|---------------|----------|------|----|----|---|--|
| MERCEDES-BENZ | SL-class | R129 | 94 | 04 | ✓ |  |
|---------------|----------|------|----|----|---|--|

### 401 212

|               |                                      |    |    |   |  |
|---------------|--------------------------------------|----|----|---|--|
| MERCEDES-BENZ | G-class 200 GE 4x4, 230 GE 4x4       | 90 | 93 | ✓ |  |
| MERCEDES-BENZ | G-class 250 GD 4x4, 300 GD 4x4       | 90 | 93 | ✓ |  |
| MERCEDES-BENZ | G-class 300 GE 4x4, 350 GD Turbo 4x4 | 90 | 93 | ✓ |  |
| MERCEDES-BENZ | G-class                              | 94 | 98 | ✓ |  |

### 401 214

|               |          |    |    |   |  |
|---------------|----------|----|----|---|--|
| MERCEDES-BENZ | MB 100 D | 87 | 92 | ✓ |  |
| MERCEDES-BENZ | MB 100 D | 92 | 93 | ✓ |  |

### 401 222

|               |                                |            |    |    |   |  |
|---------------|--------------------------------|------------|----|----|---|--|
| MERCEDES-BENZ | 200/8, 200 D/8, 220/8, 220 D/8 | W115       | 68 | 76 | ✓ |  |
| MERCEDES-BENZ | 230/4, 230/6, 230/8            | W114, W115 | 68 | 76 | ✓ |  |
| MERCEDES-BENZ | 240 D, 240 D 3.0               | W115       | 74 | 76 | ✓ |  |
| MERCEDES-BENZ | 250/8, 250 C/CE Coupé          | W114       | 68 | 76 | ✓ |  |
| MERCEDES-BENZ | 280 C, 280 CE, 280 E           | W114       | 72 | 76 | ✓ |  |
| MERCEDES-BENZ | 280 SL                         | R107       | 75 | 85 | ✓ |  |
| MERCEDES-BENZ | 280 SLC Coupé                  | C107       | 75 | 85 | ✓ |  |
| MERCEDES-BENZ | 350 SL                         | R107       | 71 | 85 | ✓ |  |
| MERCEDES-BENZ | 350 SLC Coupé                  | C107       | 71 | 85 | ✓ |  |
| MERCEDES-BENZ | 380 SL, 500 SL                 | R107       | 80 | 85 | ✓ |  |
| MERCEDES-BENZ | 380 SLC Coupé, 500 SLC Coupé   | C107       | 80 | 85 | ✓ |  |
| MERCEDES-BENZ | 450 SL                         | R107       | 73 | 85 | ✓ |  |
| MERCEDES-BENZ | 450 SLC Coupé                  | C107       | 73 | 85 | ✓ |  |

### 401 276

|               |     |      |    |    |   |  |
|---------------|-----|------|----|----|---|--|
| MERCEDES-BENZ | 280 | W114 | 72 | 76 | ✓ |  |
| PORSCHE       | 911 |      | 65 | 79 | ✓ |  |

### 401 277

|               |                   |      |    |    |   |  |
|---------------|-------------------|------|----|----|---|--|
| MERCEDES-BENZ | 190, 190 D, 190 E | W201 | 83 | 83 | ✓ |  |
|---------------|-------------------|------|----|----|---|--|

### 401 300

|           |                         |  |    |    |   |  |
|-----------|-------------------------|--|----|----|---|--|
| SMART-MCC | Smart 0.6, 0.7, 0.8 CDI |  | 98 | 04 | ✓ |  |
|-----------|-------------------------|--|----|----|---|--|

### 401 501

|               |                                     |       |       |    |   |  |
|---------------|-------------------------------------|-------|-------|----|---|--|
| MERCEDES-BENZ | CLS-class 350 Coupé, 500 Coupé C219 | 10/04 | 12/04 | ✓  |   |  |
| MERCEDES-BENZ | E-class 180 Kompressor              | W211  | 03/02 | 04 | ✓ |  |
| MERCEDES-BENZ | E-class 200, 220 CDI, 240, 270 CDI  |       | 03/02 | 05 | ✓ |  |
| MERCEDES-BENZ | E-class 320, 320 CDI, 500, 55 AMG   |       | 03/02 | 05 | ✓ |  |

### 402 030

|               |                           |            |     |    |    |   |
|---------------|---------------------------|------------|-----|----|----|---|
| MERCEDES-BENZ | 200/8, 200 D/8            | W115       | 68  | 76 | ✓  |   |
| MERCEDES-BENZ | 200, 200 D                | W123       | 76  | 85 | ✓  |   |
| MERCEDES-BENZ | 200, 200 D                | W123       | 80  | 85 | ✓  |   |
| MERCEDES-BENZ | 220/8, 220 D/8            | W115       | 68  | 76 | ✓  |   |
| MERCEDES-BENZ | 220 D                     |            | 123 | 76 | 85 | ✓ |
| MERCEDES-BENZ | 220 D                     |            | 123 | 80 | 85 | ✓ |
| MERCEDES-BENZ | 230/4, 230/6, 230/8       | W114, W115 | 68  | 76 | ✓  |   |
| MERCEDES-BENZ | 230, 230 T                |            | 123 | 76 | 85 | ✓ |
| MERCEDES-BENZ | 230, 230 T                |            | 123 | 80 | 85 | ✓ |
| MERCEDES-BENZ | 240 D, 240 D 3.0          | W115       | 74  | 76 | ✓  |   |
| MERCEDES-BENZ | 240 D, 240 TD             |            | 123 | 76 | 85 | ✓ |
| MERCEDES-BENZ | 240 D, 240 TD             |            | 123 | 80 | 85 | ✓ |
| MERCEDES-BENZ | 250/8                     | W114       | 68  | 76 | ✓  |   |
| MERCEDES-BENZ | 250 C/CE Coupé            | W114       | 69  | 76 | ✓  |   |
| MERCEDES-BENZ | 250, 250 T                |            | 123 | 76 | 85 | ✓ |
| MERCEDES-BENZ | 250, 250 T                |            | 123 | 80 | 85 | ✓ |
| MERCEDES-BENZ | 260 SE                    | W126       | 86  | 92 | ✓  |   |
| MERCEDES-BENZ | 280, 280 C, 280 CE, 280 E | W114       | 72  | 76 | ✓  |   |
| MERCEDES-BENZ | 280 S, 280 SE, 280 SEL    | W116       | 73  | 76 | ✓  |   |
| MERCEDES-BENZ | 280 C/CE Coupé            |            | 123 | 77 | 85 | ✓ |
| MERCEDES-BENZ | 280 C/CE Coupé            |            | 123 | 80 | 85 | ✓ |
| MERCEDES-BENZ | 280, 280 E, 280 TE        |            | 123 | 76 | 85 | ✓ |
| MERCEDES-BENZ | 280, 280 E, 280 TE        |            | 123 | 80 | 85 | ✓ |
| MERCEDES-BENZ | 280 S, 280 SE, 280 SEL    | W126       | 80  | 85 | ✓  |   |
| MERCEDES-BENZ | 280 SL                    | R107       | 75  | 85 | ✓  |   |

### 402 030

|               |                 |      |    |    |   |  |
|---------------|-----------------|------|----|----|---|--|
| MERCEDES-BENZ | 280 SLC Coupé   | C107 | 75 | 85 | ✓ |  |
| MERCEDES-BENZ | 300 D, 300 TD   | W123 | 76 | 85 | ✓ |  |
| MERCEDES-BENZ | 300 D, 300 TD   | W123 | 80 | 85 | ✓ |  |
| MERCEDES-BENZ | 300 SE, 300 SEL | W126 | 86 | 92 | ✓ |  |
| MERCEDES-BENZ | 300 SL          | R107 | 85 | 88 | ✓ |  |
| MERCEDES-BENZ | 350 SE, 350 SEL | W116 | 75 | 80 | ✓ |  |
| MERCEDES-BENZ | 350 SL          | R107 | 71 | 85 | ✓ |  |
| MERCEDES-BENZ | 350 SLC Coupé   | C107 | 71 | 85 | ✓ |  |
| MERCEDES-BENZ | 380 SL          | R107 | 80 | 85 | ✓ |  |
| MERCEDES-BENZ | 380 SE, 380 SEL | W126 | 80 | 85 | ✓ |  |
| MERCEDES-BENZ | 380 SLC Coupé   | C107 | 80 | 85 | ✓ |  |
| MERCEDES-BENZ | 380 SEC Coupé   | C126 | 82 | 85 | ✓ |  |
| MERCEDES-BENZ | 420 SE, 420 SEL | W126 | 86 | 92 | ✓ |  |
| MERCEDES-BENZ | 420 SEC Coupé   | C126 | 86 | 92 | ✓ |  |
| MERCEDES-BENZ | 420 SL          | R107 | 85 | 88 | ✓ |  |
| MERCEDES-BENZ | 450 SE, 450 SEL | W116 | 73 | 80 | ✓ |  |
| MERCEDES-BENZ | 450 SEL 6.9     | W116 | 75 | 80 | ✓ |  |
| MERCEDES-BENZ | 450 SL          | R107 | 73 | 85 | ✓ |  |
| MERCEDES-BENZ | 450 SLC Coupé   | C107 | 73 | 85 | ✓ |  |
| MERCEDES-BENZ | 500 SE, 500 SEL | W126 | 80 | 92 | ✓ |  |
| MERCEDES-BENZ | 500 SEC Coupé   | C126 | 82 | 92 | ✓ |  |
| MERCEDES-BENZ | 500 SL          | R107 | 80 | 88 | ✓ |  |
| MERCEDES-BENZ | 500 SLC         | C107 | 80 | 85 | ✓ |  |
| MERCEDES-BENZ | 560 SE, 560 SEL | W126 | 86 | 92 | ✓ |  |
| MERCEDES-BENZ | 560 SEC Coupé   | C126 | 86 | 92 | ✓ |  |

### 402 050

|               |                                |  |    |    |   |  |
|---------------|--------------------------------|--|----|----|---|--|
| MERCEDES-BENZ | 207 D                          |  | 78 | 90 | ✓ |  |
| MERCEDES-BENZ | 208                            |  | 78 | 82 | ✓ |  |
| MERCEDES-BENZ | 208 D                          |  | 90 | 94 | ✓ |  |
| MERCEDES-BENZ | 209 D                          |  | 84 | 90 | ✓ |  |
| MERCEDES-BENZ | 210                            |  | 83 | 94 | ✓ |  |
| MERCEDES-BENZ | 210 D                          |  | 89 | 94 | ✓ |  |
| MERCEDES-BENZ | 307 D                          |  | 78 | 90 | ✓ |  |
| MERCEDES-BENZ | 308                            |  | 78 | 82 | ✓ |  |
| MERCEDES-BENZ | 308 D                          |  | 90 | 94 | ✓ |  |
| MERCEDES-BENZ | 309 D                          |  | 83 | 90 | ✓ |  |
| MERCEDES-BENZ | 310                            |  | 83 | 94 | ✓ |  |
| MERCEDES-BENZ | 310 D                          |  | 89 | 94 | ✓ |  |
| MERCEDES-BENZ | G-class 200 GE 4x4             |  | 90 | 93 | ✓ |  |
| MERCEDES-BENZ | G-class 230 G 4x4              |  | 79 | 82 | ✓ |  |
| MERCEDES-BENZ | G-class 230 G 4x4, 230 GE 4x4  |  | 82 | 82 | ✓ |  |
| MERCEDES-BENZ | G-class 230 GE 4x4             |  | 82 | 93 | ✓ |  |
| MERCEDES-BENZ | G-class 230 GE 4x4             |  | 90 | 93 | ✓ |  |
| MERCEDES-BENZ | G-class 240 GD 4x4             |  | 79 | 82 | ✓ |  |
| MERCEDES-BENZ | G-class 240 GD 4x4             |  | 82 | 85 | ✓ |  |
| MERCEDES-BENZ | G-class 250 GD 4x4             |  | 87 | 93 | ✓ |  |
| MERCEDES-BENZ | G-class 250 GD 4x4             |  | 90 | 93 | ✓ |  |
| MERCEDES-BENZ | G-class 280 GE 4x4             |  | 79 | 82 | ✓ |  |
| MERCEDES-BENZ | G-class 280 GE 4x4             |  | 82 | 88 | ✓ |  |
| MERCEDES-BENZ | G-class 300 GD 4x4             |  | 79 | 82 | ✓ |  |
| MERCEDES-BENZ | G-class 300 GD 4x4             |  | 82 | 93 | ✓ |  |
| MERCEDES-BENZ | G-class 300 GD 4x4, 300 GE 4x4 |  | 90 | 93 | ✓ |  |
| MERCEDES-BENZ | G-class 350 GD Turbo 4x4       |  | 90 | 93 | ✓ |  |
| MERCEDES-BENZ | G-class                        |  | 94 | 98 | ✓ |  |

### 402 063

|               |         |      |    |       |   |  |
|---------------|---------|------|----|-------|---|--|
| MERCEDES-BENZ | A-class | W168 | 97 | 02/01 | ✓ |  |
| MERCEDES-BENZ | Vaneo   |      | 01 | 05    | ✓ |  |
| MERCEDES-BENZ | Viano   |      | 03 | 05    | ✓ |  |

### 402 073

|               |         |      |       |       |   |  |
|---------------|---------|------|-------|-------|---|--|
| MERCEDES-BENZ | A-class | W168 | 02/01 | 08/04 | ✓ |  |
|---------------|---------|------|-------|-------|---|--|

### 402 080

|               |               |      |    |    |   |  |
|---------------|---------------|------|----|----|---|--|
| MERCEDES-BENZ | 200           | T124 | 86 | 93 | ✓ |  |
| MERCEDES-BENZ | 220 TE        | T124 | 93 | 94 | ✓ |  |
| MERCEDES-BENZ | 230 E, 230 TE | T124 | 86 | 93 | ✓ |  |

**SATZ-VERZEICHNIS**  
**KITS INDEX**  
**INDEX DES KITS**



**402 080**



|               |                                  |       |       |       |   |
|---------------|----------------------------------|-------|-------|-------|---|
| MERCEDES-BENZ | 250 D                            | T124  | 86    | 93    | ✓ |
| MERCEDES-BENZ | 250 D                            | W124  | 85    | 93    | ✓ |
| MERCEDES-BENZ | 250 TD                           | T124  | 89    | 93    | ✓ |
| MERCEDES-BENZ | 250 D, 250 TD Turbo Diesel, 260  | ET124 | 86    | 93    | ✓ |
| MERCEDES-BENZ | 260 E                            | W124  | 85    | 93    | ✓ |
| MERCEDES-BENZ | 280 E                            | W124  | 93    | 93    | ✓ |
| MERCEDES-BENZ | 280 E, 280 TE                    | T124  | 93    | 95    | ✓ |
| MERCEDES-BENZ | 300                              | T124  | 86    | 93    | ✓ |
| MERCEDES-BENZ | 300 4-Matic                      | T124  | 87    | 93    | ✓ |
| MERCEDES-BENZ | 320 TE                           | T124  | 93    | 94    | ✓ |
| MERCEDES-BENZ | E-class 250 Diesel               | W124  | 07/93 | 06/95 | ✓ |
| MERCEDES-BENZ | E-class 250 Diesel               | T124  | 06/93 | 06/96 | ✓ |
| MERCEDES-BENZ | E-class 250 Turbo Diesel         | T124  | 94    | 06/96 | ✓ |
| MERCEDES-BENZ | E-class 280                      | W124  | 06/93 | 06/95 | ✓ |
| MERCEDES-BENZ | E-class 300 Diesel               | T124  | 06/93 | 06/96 | ✓ |
| MERCEDES-BENZ | E-class 300 Turbo Diesel         | T124  | 93    | 06/96 | ✓ |
| MERCEDES-BENZ | E-class 300 4-Matic              | T124  | 06/93 | 06/96 | ✓ |
| MERCEDES-BENZ | E-class 300 Turbo Diesel 4-Matic | T124  | 06/93 | 06/96 | ✓ |

**402 081**



|               |                   |      |    |    |   |
|---------------|-------------------|------|----|----|---|
| MERCEDES-BENZ | S-class           | W220 | 98 | 04 | ✓ |
| MERCEDES-BENZ | SL-class Roadster | R230 | 01 | 04 | ✓ |

**402 116**



|               |                               |      |       |       |   |
|---------------|-------------------------------|------|-------|-------|---|
| MERCEDES-BENZ | 190, 190 D, 190 E             | W201 | 83    | 83    | ✓ |
| MERCEDES-BENZ | 190 E 1.8, 190 E 2.3          | W201 | 86    | 93    | ✓ |
| MERCEDES-BENZ | 190 E 2.3 16V                 | W201 | 84    | 93    | ✓ |
| MERCEDES-BENZ | 190 E 2.5, 2.5 16V            | W201 | 88    | 93    | ✓ |
| MERCEDES-BENZ | 190 E 2.6                     | W201 | 86    | 93    | ✓ |
| MERCEDES-BENZ | 200                           | W124 | 85    | 93    | ✓ |
| MERCEDES-BENZ | 200 CE Cabriolet, Coupé       | C124 | 90    | 94    | ✓ |
| MERCEDES-BENZ | 220 E                         | W124 | 93    | 93    | ✓ |
| MERCEDES-BENZ | 220 CE Cabriolet, Coupé       | C124 | 93    | 94    | ✓ |
| MERCEDES-BENZ | 230 CE Coupé                  | C124 | 87    | 94    | ✓ |
| MERCEDES-BENZ | 230 E, 250 D                  | W124 | 85    | 93    | ✓ |
| MERCEDES-BENZ | 250 D Turbo Diesel, 260 E     | W124 | 85    | 93    | ✓ |
| MERCEDES-BENZ | 260 E 4-Matic                 | W124 | 87    | 93    | ✓ |
| MERCEDES-BENZ | 280 E                         | W124 | 93    | 93    | ✓ |
| MERCEDES-BENZ | 300                           | C124 | 87    | 94    | ✓ |
| MERCEDES-BENZ | 300 Cabriolet                 | C124 | 90    | 94    | ✓ |
| MERCEDES-BENZ | 300                           | W124 | 85    | 93    | ✓ |
| MERCEDES-BENZ | 300 4-Matic                   | W124 | 87    | 93    | ✓ |
| MERCEDES-BENZ | 300 SL, 300 SL-24             | R129 | 89    | 93    | ✓ |
| MERCEDES-BENZ | 320 CE Coupé, 320 E Cabriolet | C124 | 93    | 93    | ✓ |
| MERCEDES-BENZ | 320 E, 400 E                  | W124 | 93    | 93    | ✓ |
| MERCEDES-BENZ | 500 E                         | W124 | 90    | 93    | ✓ |
| MERCEDES-BENZ | 500 SL, 600 SL                | R129 | 89    | 93    | ✓ |
| MERCEDES-BENZ | C-class                       | W202 | 93    | 03/01 | ✓ |
| MERCEDES-BENZ | C-class                       | T202 | 96    | 03/01 | ✓ |
| MERCEDES-BENZ | CLK-class                     | C208 | 97    | 04    | ✓ |
| MERCEDES-BENZ | CLK-class Cabriolet           | A208 | 98    | 04    | ✓ |
| MERCEDES-BENZ | CLK-class                     | C209 | 06/02 | 04    | ✓ |
| MERCEDES-BENZ | CLK-class Cabriolet           | A209 | 02/03 | 04    | ✓ |
| MERCEDES-BENZ | E-class 200, 200 Diesel       | W124 | 06/93 | 06/95 | ✓ |
| MERCEDES-BENZ | E-class 200 Diesel            | W210 | 94    | 03/02 | ✓ |
| MERCEDES-BENZ | E-class 200 Cabriolet, Coupé  | C124 | 93    | 02    | ✓ |
| MERCEDES-BENZ | E-class 200, 200 Kompressor   | W210 | 06/95 | 03/02 | ✓ |
| MERCEDES-BENZ | E-class 220                   | W124 | 06/93 | 06/95 | ✓ |
| MERCEDES-BENZ | E-class 220 Cabriolet, Coupé  | C124 | 93    | 02    | ✓ |
| MERCEDES-BENZ | E-class 220 Diesel, CDI       | W210 | 07/95 | 03/02 | ✓ |
| MERCEDES-BENZ | E-class 230                   | W210 | 96    | 03/02 | ✓ |
| MERCEDES-BENZ | E-class 240                   | W210 | 06/95 | 03/02 | ✓ |
| MERCEDES-BENZ | E-class 250 Diesel            | W124 | 07/93 | 06/95 | ✓ |
| MERCEDES-BENZ | E-class 250 Diesel            | W210 | 07/95 | 03/02 | ✓ |
| MERCEDES-BENZ | E-class 250 Turbo Diesel      | W124 | 06/93 | 06/95 | ✓ |
| MERCEDES-BENZ | E-class 250 Turbo Diesel      | W210 | 07/97 | 03/02 | ✓ |
| MERCEDES-BENZ | E-class 280                   | W124 | 06/93 | 06/95 | ✓ |
| MERCEDES-BENZ | E-class 280, 280 4-Matic      | W210 | 96    | 03/02 | ✓ |

**402 116**



|               |                                  |      |       |       |   |
|---------------|----------------------------------|------|-------|-------|---|
| MERCEDES-BENZ | E-class 290 Turbo Diesel         | W210 | 96    | 07/99 | ✓ |
| MERCEDES-BENZ | E-class 300                      | W124 | 94    | 95    | ✓ |
| MERCEDES-BENZ | E-class 300 Diesel               | W124 | 93    | 95    | ✓ |
| MERCEDES-BENZ | E-class 300 Diesel               | W210 | 07/95 | 06/97 | ✓ |
| MERCEDES-BENZ | E-class 300 Turbo Diesel         | W124 | 93    | 95    | ✓ |
| MERCEDES-BENZ | E-class 300 Turbo Diesel         | W210 | 96    | 07/99 | ✓ |
| MERCEDES-BENZ | E-class 300 4-Matic              | W124 | 94    | 95    | ✓ |
| MERCEDES-BENZ | E-class 300 Turbo Diesel 4-Matic | W124 | 93    | 95    | ✓ |
| MERCEDES-BENZ | E-class 320                      | W124 | 06/93 | 06/95 | ✓ |
| MERCEDES-BENZ | E-class 320                      | W210 | 06/95 | 03/02 | ✓ |
| MERCEDES-BENZ | E-class 320 Cabriolet            | C124 | 94    | 02    | ✓ |
| MERCEDES-BENZ | E-class 320 Coupé                | C124 | 06/93 | 02    | ✓ |
| MERCEDES-BENZ | E-class 320 4-Matic              | W210 | 06/97 | 03/02 | ✓ |
| MERCEDES-BENZ | E-class 420                      | W124 | 06/93 | 06/95 | ✓ |
| MERCEDES-BENZ | E-class 420                      | W210 | 96    | 06/97 | ✓ |
| MERCEDES-BENZ | E-class 430                      | W210 | 06/95 | 03/02 | ✓ |
| MERCEDES-BENZ | E-class 500                      | W124 | 06/93 | 06/95 | ✓ |
| MERCEDES-BENZ | E-class 55 AMG                   | W210 | 08/97 | 03/02 | ✓ |
| MERCEDES-BENZ | SL-class                         | R129 | 94    | 04    | ✓ |
| MERCEDES-BENZ | SLK-class                        | R170 | 96    | 04/04 | ✓ |

**402 117**



|               |                            |       |       |   |
|---------------|----------------------------|-------|-------|---|
| MERCEDES-BENZ | Sprinter 208 D, 212 D, 214 | 95    | 05/06 | ✓ |
| MERCEDES-BENZ | Sprinter 308 D, 312 D, 314 | 95    | 05/06 | ✓ |
| MERCEDES-BENZ | Sprinter 408 D, 412 D, 414 | 95    | 05/06 | ✓ |
| VOLKSWAGEN    | LT 28 II                   | 04/96 | 04    | ✓ |
| VOLKSWAGEN    | LT 35 II                   | 04/96 | 04    | ✓ |

**402 119**



|               |                            |    |       |   |
|---------------|----------------------------|----|-------|---|
| MERCEDES-BENZ | Sprinter 408 D, 412 D, 414 | 96 | 05/06 | ✓ |
| VOLKSWAGEN    | LT 46                      | 96 | 04    | ✓ |

**402 143**



|               |          |    |    |   |
|---------------|----------|----|----|---|
| MERCEDES-BENZ | MB 100 D | 92 | 93 | ✓ |
|---------------|----------|----|----|---|

**402 159**



|               |         |      |       |    |   |
|---------------|---------|------|-------|----|---|
| MERCEDES-BENZ | C-class | W203 | 05/00 | 04 | ✓ |
|---------------|---------|------|-------|----|---|

**402 216**



|               |          |    |    |   |
|---------------|----------|----|----|---|
| MERCEDES-BENZ | MB 100 D | 87 | 92 | ✓ |
|---------------|----------|----|----|---|

**402 242**



|               |                   |      |    |    |   |
|---------------|-------------------|------|----|----|---|
| MERCEDES-BENZ | 300, 400, 500     | W140 | 91 | 93 | ✓ |
| MERCEDES-BENZ | 500 SEC Coupé     | C140 | 92 | 93 | ✓ |
| MERCEDES-BENZ | 600 SE, 600 SEL   | W140 | 91 | 93 | ✓ |
| MERCEDES-BENZ | 600 SEC-V12 Coupé | C140 | 92 | 93 | ✓ |
| MERCEDES-BENZ | CL-class Coupé    | C140 | 97 | 03 | ✓ |
| MERCEDES-BENZ | S-class           | W140 | 94 | 98 | ✓ |
| MERCEDES-BENZ | S-class Coupé     | C140 | 92 | 99 | ✓ |

**402 243**



|               |                               |      |    |       |   |
|---------------|-------------------------------|------|----|-------|---|
| MERCEDES-BENZ | E-class 200, 200 Kompressor   | T210 | 96 | 02    | ✓ |
| MERCEDES-BENZ | E-class 230, 240, 250         | T210 | 96 | 02    | ✓ |
| MERCEDES-BENZ | E-class 280, 280 4-Matic      | T210 | 96 | 02    | ✓ |
| MERCEDES-BENZ | E-class 290 Turbo Diesel      | T210 | 96 | 07/99 | ✓ |
| MERCEDES-BENZ | E-class 300 Turbo Diesel      | T210 | 96 | 07/99 | ✓ |
| MERCEDES-BENZ | E-class 320, 250 Turbo Diesel | T210 | 96 | 02    | ✓ |
| MERCEDES-BENZ | E-class 320 4-Matic           | T210 | 97 | 02    | ✓ |
| MERCEDES-BENZ | E-class 420, 430, 55 AMG      | T210 | 96 | 02    | ✓ |
| MERCEDES-BENZ | S-class Coupé                 | C215 | 99 | 04    | ✓ |

**402 301**



|           |                         |    |    |   |
|-----------|-------------------------|----|----|---|
| SMART-MCC | Smart 0.6, 0.7, 0.8 CDI | 98 | 04 | ✓ |
|-----------|-------------------------|----|----|---|

**402 467**



|           |          |       |    |   |
|-----------|----------|-------|----|---|
| SMART-MCC | For Four | 04/04 | 06 | ✓ |
|-----------|----------|-------|----|---|

**402 505**



|               |                                |      |       |       |   |
|---------------|--------------------------------|------|-------|-------|---|
| MERCEDES-BENZ | CLS-class 350 Coupé, 500 Coupé | C219 | 10/04 | 12/04 | ✓ |
| MERCEDES-BENZ | E-class 180 Kompressor, 200    | W211 | 03/02 | 04    | ✓ |

**402 505**

|               |                                     |      |       |    |  |   |
|---------------|-------------------------------------|------|-------|----|--|---|
| MERCEDES-BENZ | E-class 220 CDI, 240, 270 CDI       | W211 | 03/02 | 05 |  | ✓ |
| MERCEDES-BENZ | E-class 320, 320CDI, 500, 55AMGV211 | W211 | 03/02 | 05 |  | ✓ |

**402 827**

|               |         |      |       |       |  |   |
|---------------|---------|------|-------|-------|--|---|
| MERCEDES-BENZ | A-class | W169 | 09/04 | 12/06 |  | ✓ |
| MERCEDES-BENZ | B-class | W245 | 09/04 | 12/06 |  | ✓ |

**501 049**

|     |     |     |    |    |   |  |
|-----|-----|-----|----|----|---|--|
| BMW | M 3 | E30 | 85 | 92 | ✓ |  |
|-----|-----|-----|----|----|---|--|

**501 088**

|     |                  |     |       |       |   |  |
|-----|------------------|-----|-------|-------|---|--|
| BMW | 316              | E30 | 82    | 91    | ✓ |  |
| BMW | 316 i/5 Touring  | E30 | 91    | 94    | ✓ |  |
| BMW | 318 i            | E30 | 82    | 87    | ✓ |  |
| BMW | 318              | E30 | 87    | 91    | ✓ |  |
| BMW | 318 is           | E30 | 89    | 91    | ✓ |  |
| BMW | 318 ic Cabriolet | E30 | 90    | 93    | ✓ |  |
| BMW | 318 i/5 Touring  | E30 | 89    | 94    | ✓ |  |
| BMW | 320 i            | E30 | 82    | 91    | ✓ |  |
| BMW | 320 i/5 Touring  | E30 | 88    | 91    | ✓ |  |
| BMW | 320 ic Cabriolet | E30 | 83    | 09/85 | ✓ |  |
| BMW | 323 i            | E30 | 81    | 86    | ✓ |  |
| BMW | 324              | E30 | 85    | 90    | ✓ |  |
| BMW | 324 td/5 Touring | E30 | 81    | 93    | ✓ |  |
| BMW | 325 e            | E30 | 01/85 | 90    | ✓ |  |
| BMW | 325 i            | E30 | 85    | 91    | ✓ |  |
| BMW | 325 ic Cabriolet | E30 | 85    | 92    | ✓ |  |

**501 092**

|     |               |     |       |       |   |  |
|-----|---------------|-----|-------|-------|---|--|
| BMW | 535 Mi        | E12 | 80    | 81    | ✓ |  |
| BMW | 628 CSi Coupé | E24 | 79    | 05/82 | ✓ |  |
| BMW | 630 CS Coupé  | E24 | 07/78 | 79    | ✓ |  |
| BMW | 633 CSi Coupé | E24 | 07/78 | 81    | ✓ |  |
| BMW | 635 CSi Coupé | E24 | 06/78 | 05/82 | ✓ |  |
| BMW | 728           | E23 | 77    | 86    | ✓ |  |
| BMW | 730           | E23 | 76    | 79    | ✓ |  |
| BMW | 732 i         | E23 | 79    | 86    | ✓ |  |
| BMW | 733 i         | E23 | 76    | 82    | ✓ |  |
| BMW | 735           | E23 | 79    | 86    | ✓ |  |
| BMW | 745 i         | E23 | 79    | 86    | ✓ |  |

**501 112**

|     |                  |     |       |    |   |  |
|-----|------------------|-----|-------|----|---|--|
| BMW | 316              | E30 | 82    | 91 | ✓ |  |
| BMW | 316 i/5 Touring  | E30 | 91    | 94 | ✓ |  |
| BMW | 318 i            | E30 | 82    | 87 | ✓ |  |
| BMW | 318              | E30 | 87    | 91 | ✓ |  |
| BMW | 318 is           | E30 | 89    | 91 | ✓ |  |
| BMW | 318 ic Cabriolet | E30 | 90    | 93 | ✓ |  |
| BMW | 318 i/5 Touring  | E30 | 89    | 94 | ✓ |  |
| BMW | 320 i            | E30 | 82    | 91 | ✓ |  |
| BMW | 320 is           | E30 | 87    | 90 | ✓ |  |
| BMW | 320 i/5 Touring  | E30 | 88    | 91 | ✓ |  |
| BMW | 320 ic Cabriolet | E30 | 10/85 | 93 | ✓ |  |
| BMW | 323 i            | E30 | 81    | 86 | ✓ |  |
| BMW | 324              | E30 | 85    | 90 | ✓ |  |
| BMW | 324 td/5 Touring | E30 | 81    | 93 | ✓ |  |
| BMW | 325 e            | E30 | 01/85 | 90 | ✓ |  |
| BMW | 325 i            | E30 | 85    | 91 | ✓ |  |
| BMW | 325 ic Cabriolet | E30 | 85    | 92 | ✓ |  |
| BMW | 325 i/5 Touring  | E30 | 87    | 93 | ✓ |  |
| BMW | Z 1              |     | 88    | 91 | ✓ |  |

**501 114**

|     |              |     |    |    |   |  |
|-----|--------------|-----|----|----|---|--|
| BMW | 518          | E28 | 80 | 87 | ✓ |  |
| BMW | 520 i        | E28 | 81 | 87 | ✓ |  |
| BMW | 524 d        | E28 | 86 | 87 | ✓ |  |
| BMW | 524 td       | E28 | 82 | 87 | ✓ |  |
| BMW | 525 i, 525 e | E28 | 81 | 87 | ✓ |  |
| BMW | 528 i        | E28 | 80 | 87 | ✓ |  |

**501 114**

|     |                |     |       |    |   |  |
|-----|----------------|-----|-------|----|---|--|
| BMW | 535            | E28 | 84    | 88 | ✓ |  |
| BMW | 628 CSi Coupé  | E24 | 06/82 | 87 | ✓ |  |
| BMW | 635 CSi Coupé  | E24 | 06/82 | 89 | ✓ |  |
| BMW | 635 MCSi Coupé | E24 | 83    | 89 | ✓ |  |
| BMW | M 5            | E28 | 84    | 87 | ✓ |  |

**501 121**

|     |                      |     |    |    |   |  |
|-----|----------------------|-----|----|----|---|--|
| BMW | 520 i, 520 i Touring | E39 | 95 | 04 | ✓ |  |
| BMW | 520 d, 520 d Touring | E39 | 00 | 04 | ✓ |  |
| BMW | 523 i, i Touring     | E39 | 95 | 00 | ✓ |  |
| BMW | 525 i                | E39 | 96 | 04 | ✓ |  |
| BMW | 525 i Touring        | E39 | 00 | 04 | ✓ |  |
| BMW | 525 d, d Touring     | E39 | 00 | 04 | ✓ |  |
| BMW | 525 td, 525 tds      | E39 | 96 | 04 | ✓ |  |
| BMW | 525 tds Touring      | E39 | 97 | 04 | ✓ |  |
| BMW | 528 i, i Touring     | E39 | 95 | 01 | ✓ |  |
| BMW | 530 i, i Touring     | E39 | 00 | 04 | ✓ |  |
| BMW | 530 d                | E39 | 97 | 04 | ✓ |  |
| BMW | 530 d Touring        | E39 | 98 | 04 | ✓ |  |
| BMW | 535 i                | E39 | 95 | 04 | ✓ |  |
| BMW | 540 i                | E39 | 96 | 04 | ✓ |  |
| BMW | 540 i Touring        | E39 | 97 | 04 | ✓ |  |
| BMW | M 5                  | E39 | 98 | 02 | ✓ |  |
| BMW | Z 8                  |     | 00 | 06 | ✓ |  |

**501 133**

|     |                    |     |    |    |   |  |
|-----|--------------------|-----|----|----|---|--|
| BMW | 725 tds, 728 i, iL | E38 | 95 | 01 | ✓ |  |
| BMW | 730 i, iL          | E38 | 93 | 01 | ✓ |  |
| BMW | 730 d              | E38 | 98 | 01 | ✓ |  |
| BMW | 735 i, iL          | E38 | 94 | 01 | ✓ |  |
| BMW | 740 i, iL          | E38 | 95 | 01 | ✓ |  |
| BMW | 740 d              | E38 | 99 | 01 | ✓ |  |
| BMW | 750 i, iL          | E38 | 94 | 01 | ✓ |  |

**501 136**

|     |                                 |     |    |    |   |  |
|-----|---------------------------------|-----|----|----|---|--|
| BMW | 316 i                           | E36 | 90 | 94 | ✓ |  |
| BMW | 316 i                           | E36 | 90 | 91 | ✓ |  |
| BMW | 316 i                           | E36 | 92 | 94 | ✓ |  |
| BMW | 316 i                           | E36 | 93 | 98 | ✓ |  |
| BMW | 316 i Coupé, 316 Compact        | E36 | 93 | 99 | ✓ |  |
| BMW | 316 i Touring                   | E36 | 96 | 99 | ✓ |  |
| BMW | 316 i                           | E46 | 98 | 04 | ✓ |  |
| BMW | 316 i Touring                   | E46 | 02 | 04 | ✓ |  |
| BMW | 316 Ci Coupé                    | E46 | 98 | 04 | ✓ |  |
| BMW | 316 ti Compact                  | E46 | 01 | 04 | ✓ |  |
| BMW | 318 i                           | E36 | 89 | 94 | ✓ |  |
| BMW | 318 i                           | E36 | 89 | 91 | ✓ |  |
| BMW | 318 i                           | E36 | 92 | 94 | ✓ |  |
| BMW | 318 i                           | E36 | 93 | 98 | ✓ |  |
| BMW | 318 is                          | E36 | 91 | 99 | ✓ |  |
| BMW | 318 i Cabriolet                 | E36 | 92 | 99 | ✓ |  |
| BMW | 318 i Compact                   | E36 | 94 | 99 | ✓ |  |
| BMW | 318 i Touring, 318 tds Compact  | E36 | 95 | 99 | ✓ |  |
| BMW | 318 tds, tds Touring            | E36 | 94 | 99 | ✓ |  |
| BMW | 318 i                           | E46 | 97 | 05 | ✓ |  |
| BMW | 318 i Touring, 318 Ci Coupé     | E46 | 99 | 05 | ✓ |  |
| BMW | 318 Ci Cabriolet, 318 d         | E46 | 01 | 05 | ✓ |  |
| BMW | 318 td Compact                  | E46 | 03 | 05 | ✓ |  |
| BMW | 318 ti Compact                  | E46 | 01 | 05 | ✓ |  |
| BMW | 320 i, 320 i Cabriolet          | E36 | 90 | 99 | ✓ |  |
| BMW | 320 i Coupé                     | E36 | 92 | 99 | ✓ |  |
| BMW | 320 i Touring                   | E36 | 95 | 99 | ✓ |  |
| BMW | 320 i                           | E46 | 98 | 05 | ✓ |  |
| BMW | 320 i Touring, 320 Ci Cabriolet | E46 | 00 | 05 | ✓ |  |
| BMW | 320 Ci Coupé                    | E46 | 99 | 05 | ✓ |  |
| BMW | 320 Cd Coupé                    | E46 | 03 | 05 | ✓ |  |
| BMW | 320 d                           | E46 | 98 | 05 | ✓ |  |
| BMW | 320 d Touring                   | E46 | 00 | 05 | ✓ |  |

**501 136**



|     |                                 |     |       |    |   |  |
|-----|---------------------------------|-----|-------|----|---|--|
| BMW | 320 td Compact                  | E46 | 01    | 05 | ✓ |  |
| BMW | 323 i                           | E36 | 94    | 99 | ✓ |  |
| BMW | 323 ti Compact                  | E36 | 97    | 00 | ✓ |  |
| BMW | 323 i                           | E46 | 97    | 04 | ✓ |  |
| BMW | 323 Ci Coupé                    | E46 | 99    | 04 | ✓ |  |
| BMW | 325 i                           | E36 | 89    | 99 | ✓ |  |
| BMW | 325 i Cabriolet                 | E36 | 93    | 99 | ✓ |  |
| BMW | 325 i Coupé                     | E36 | 92    | 99 | ✓ |  |
| BMW | 325 td                          | E36 | 91    | 99 | ✓ |  |
| BMW | 325 tds Touring                 | E36 | 95    | 99 | ✓ |  |
| BMW | 325 i                           | E46 | 99    | 05 | ✓ |  |
| BMW | 325 i Touring, 325 Ci Cabriolet | E46 | 00    | 05 | ✓ |  |
| BMW | 325 Ci Coupé                    | E46 | 00    | 05 | ✓ |  |
| BMW | 325 ti Compact                  | E46 | 01    | 05 | ✓ |  |
| BMW | 328 i, 328 i Cabriolet          | E36 | 95    | 99 | ✓ |  |
| BMW | 328 i Coupé, 328 i Touring      | E36 | 95    | 99 | ✓ |  |
| BMW | 328 i, Ci Coupé, i Touring      | E46 | 97    | 01 | ✓ |  |
| BMW | 330 i, i Touring, Ci Cabriolet  | E46 | 99    | 04 | ✓ |  |
| BMW | 330 Ci Coupé                    | E46 | 99    | 04 | ✓ |  |
| BMW | 330 Cd Coupé                    | E46 | 03    | 04 | ✓ |  |
| BMW | 330 d                           | E46 | 99    | 04 | ✓ |  |
| BMW | 518 i                           | E34 | 04/91 | 97 | ✓ |  |
| BMW | 518 i                           | E34 | 12/91 | 94 | ✓ |  |
| BMW | 518 i                           | E34 | 12/91 | 95 | ✓ |  |
| BMW | 518 i Touring                   | E34 | 91    | 97 | ✓ |  |
| BMW | 520 i                           | E34 | 04/91 | 95 | ✓ |  |
| BMW | 520 i                           | E34 | 12/91 | 95 | ✓ |  |
| BMW | 520 i Touring                   | E34 | 90    | 96 | ✓ |  |
| BMW | 524 td                          | E34 | 04/91 | 97 | ✓ |  |
| BMW | 525 i                           | E34 | 04/91 | 97 | ✓ |  |
| BMW | 525 td                          | E34 | 92    | 96 | ✓ |  |
| BMW | 525 tds                         | E34 | 91    | 97 | ✓ |  |
| BMW | 525 Touring                     | E34 | 90    | 97 | ✓ |  |
| BMW | 530 i                           | E34 | 92    | 95 | ✓ |  |
| BMW | 530 i Touring                   | E34 | 92    | 97 | ✓ |  |
| BMW | 535 i                           | E34 | 12/91 | 93 | ✓ |  |
| BMW | 540 i                           | E34 | 92    | 96 | ✓ |  |
| BMW | 540 i Touring                   | E34 | 93    | 96 | ✓ |  |
| BMW | 730 i                           | E32 | 91    | 94 | ✓ |  |
| BMW | 735 i                           | E32 | 12/91 | 92 | ✓ |  |
| BMW | 735 iL                          | E32 | 12/91 | 92 | ✓ |  |
| BMW | 740                             | E32 | 12/91 | 94 | ✓ |  |
| BMW | 750 i                           | E32 | 12/91 | 94 | ✓ |  |
| BMW | 750 iL                          | E32 | 12/91 | 94 | ✓ |  |
| BMW | 840 Coupé                       | E31 | 92    | 99 | ✓ |  |
| BMW | 850 i Coupé                     | E31 | 04/92 | 94 | ✓ |  |
| BMW | 850 Ci Coupé                    | E31 | 04/92 | 99 | ✓ |  |
| BMW | M 3                             | E36 | 92    | 99 | ✓ |  |
| BMW | Z 3 1.8                         | E36 | 94    | 98 | ✓ |  |
| BMW | Z 3 1.9                         | E36 | 94    | 02 | ✓ |  |
| BMW | Z 3 1.9                         | E36 | 94    | 99 | ✓ |  |
| BMW | Z 3 2.0, 2.2, 2.8, 3.0, 3.2     | E36 | 96    | 02 | ✓ |  |
| BMW | Z 4 2.2i, 2.5i, 3.0i            |     | 03    | 06 | ✓ |  |

**501 147**



|     |                      |          |    |    |   |  |
|-----|----------------------|----------|----|----|---|--|
| BMW | 730 i, Li, 760 i, Li | E65, E66 | 03 | 06 | ✓ |  |
| BMW | 730 d, 735 i, Li     | E65, E66 | 01 | 06 | ✓ |  |
| BMW | 740 d, 745 i, Li     | E65, E66 | 01 | 06 | ✓ |  |

**501 158**



|     |                        |          |       |    |   |  |
|-----|------------------------|----------|-------|----|---|--|
| BMW | 325 xi, 325 xi Touring | E90, E91 | 01/05 | 06 | ✓ |  |
| BMW | 330 xi, 330 xi Touring | E90, E91 | 01/05 | 06 | ✓ |  |
| BMW | 330 xd, 330 xd Touring | E90      | 01/05 | 06 | ✓ |  |
| BMW | X 3                    |          | 04    | 05 | ✓ |  |
| BMW | X 5                    |          | 00    | 05 | ✓ |  |

**501 161**



|      |             |  |    |    |   |  |
|------|-------------|--|----|----|---|--|
| MINI | Mini Cooper |  | 01 | 05 | ✓ |  |
|------|-------------|--|----|----|---|--|

**501 161**



|      |                        |  |    |    |   |  |
|------|------------------------|--|----|----|---|--|
| MINI | Mini Cooper S          |  | 02 | 05 | ✓ |  |
| MINI | Mini One               |  | 00 | 05 | ✓ |  |
| MINI | Mini One D, Mini Works |  | 03 | 05 | ✓ |  |

**501 170**



|     |                             |     |    |       |   |  |
|-----|-----------------------------|-----|----|-------|---|--|
| BMW | 518 i                       | E34 | 88 | 11/91 | ✓ |  |
| BMW | 520 i, 524 td, 525 i, 535 i | E34 | 87 | 11/91 | ✓ |  |
| BMW | 530 i                       | E34 | 87 | 90    | ✓ |  |
| BMW | 730 i, 750 iL               | E32 | 86 | 02/92 | ✓ |  |
| BMW | 735 i                       | E32 | 85 | 02/92 | ✓ |  |
| BMW | 735 iL, 750 i               | E32 | 87 | 02/92 | ✓ |  |
| BMW | 850 i Coupé, Ci Coupé       | E31 | 89 | 03/92 | ✓ |  |
| BMW | 850 CSi Coupé               | E31 | 92 | 96    | ✓ |  |

**501 184**



|     |                             |     |    |       |   |  |
|-----|-----------------------------|-----|----|-------|---|--|
| BMW | 320/6, 323 i                | E21 | 77 | 82    | ✓ |  |
| BMW | 518                         | E12 | 74 | 81    | ✓ |  |
| BMW | 520                         | E12 | 72 | 81    | ✓ |  |
| BMW | 525                         | E12 | 73 | 81    | ✓ |  |
| BMW | 528                         | E12 | 74 | 81    | ✓ |  |
| BMW | 630 CS Coupé, 633 CSi Coupé | E24 | 75 | 06/78 | ✓ |  |

**501 194**



|     |          |     |    |    |   |  |
|-----|----------|-----|----|----|---|--|
| BMW | 315      | E21 | 80 | 83 | ✓ |  |
| BMW | 316, 318 | E21 | 75 | 83 | ✓ |  |

**501 513**



|     |                              |     |       |       |   |  |
|-----|------------------------------|-----|-------|-------|---|--|
| BMW | 118 i, d, 120 i, d           | E87 | 04    | 06    | ✓ |  |
| BMW | 130 i                        | E87 | 05    | 06    | ✓ |  |
| BMW | 318 i, 318 d                 | E90 | 09/05 | 06    | ✓ |  |
| BMW | 318 i Touring, 318 d Touring | E91 | 01/06 | 12/06 | ✓ |  |
| BMW | 320 i, d, 325 i, 330 i, d    | E90 | 01/05 | 06    | ✓ |  |
| BMW | 320 i Touring, 320 d Touring | E91 | 01/05 | 06    | ✓ |  |
| BMW | 325 i Touring                | E91 | 01/05 | 06    | ✓ |  |
| BMW | 330 i Touring, 330 d Touring | E91 | 01/05 | 06    | ✓ |  |

**501 653**



|     |                              |     |    |    |   |  |
|-----|------------------------------|-----|----|----|---|--|
| BMW | 520 i, 525 i                 | E60 | 03 | 06 | ✓ |  |
| BMW | 520 i Touring, 525 i Touring | E61 | 04 | 06 | ✓ |  |
| BMW | 525 d, 535 d                 | E60 | 04 | 06 | ✓ |  |
| BMW | 525 d Touring, 530 i Touring | E60 | 03 | 06 | ✓ |  |
| BMW | 530 i, 530 d                 | E61 | 04 | 06 | ✓ |  |
| BMW | 530 d Touring, 535 d Touring | E60 | 04 | 06 | ✓ |  |
| BMW | 545 i                        | E60 | 03 | 06 | ✓ |  |
| BMW | 545 i Touring                | E61 | 04 | 06 | ✓ |  |
| BMW | 645 Ci Coupé                 | E63 | 04 | 06 | ✓ |  |
| BMW | 645 Ci Cabriolet             | E64 | 04 | 06 | ✓ |  |

**502 066**



|     |             |     |       |    |   |  |
|-----|-------------|-----|-------|----|---|--|
| BMW | 518         | E28 | 80    | 87 | ✓ |  |
| BMW | 518 i       | E34 | 88    | 95 | ✓ |  |
| BMW | 520 i       | E28 | 80    | 95 | ✓ |  |
| BMW | 524 td      | E28 | 82    | 97 | ✓ |  |
| BMW | 525 e       | E28 | 05/86 | 87 | ✓ |  |
| BMW | 525 i       | E34 | 05/86 | 97 | ✓ |  |
| BMW | 525 ix, tds | E34 | 91    | 97 | ✓ |  |
| BMW | 525 td      | E34 | 92    | 96 | ✓ |  |

**502 068**



|     |                  |     |       |       |   |  |
|-----|------------------|-----|-------|-------|---|--|
| BMW | 316              | E30 | 82    | 91    | ✓ |  |
| BMW | 316 i/5 Touring  | E30 | 91    | 94    | ✓ |  |
| BMW | 318 i            | E30 | 82    | 87    | ✓ |  |
| BMW | 318              | E30 | 87    | 91    | ✓ |  |
| BMW | 320 i            | E30 | 82    | 91    | ✓ |  |
| BMW | 320 ic Cabriolet | E30 | 83    | 09/85 | ✓ |  |
| BMW | 323 i            | E30 | 81    | 09/85 | ✓ |  |
| BMW | 324              | E30 | 85    | 90    | ✓ |  |
| BMW | 325 e            | E30 | 01/85 | 09/85 | ✓ |  |



**502 070**

|     |                |     |       |       |  |   |
|-----|----------------|-----|-------|-------|--|---|
| BMW | 518 i Touring  | E34 | 91    | 97    |  | ✓ |
| BMW | 520 i          | E28 | 80    | 09/86 |  | ✓ |
| BMW | 520 i Touring  | E34 | 90    | 96    |  | ✓ |
| BMW | 524 d          | E28 | 86    | 87    |  | ✓ |
| BMW | 524 td         | E28 | 82    | 09/86 |  | ✓ |
| BMW | 525 i          | E28 | 81    | 09/86 |  | ✓ |
| BMW | 525 e          | E28 | 81    | 04/86 |  | ✓ |
| BMW | 525 Touring    | E34 | 90    | 97    |  | ✓ |
| BMW | 528 i          | E28 | 80    | 87    |  | ✓ |
| BMW | 530 i          | E34 | 87    | 90    |  | ✓ |
| BMW | 530 i          | E34 | 92    | 95    |  | ✓ |
| BMW | 530 i Touring  | E34 | 92    | 97    |  | ✓ |
| BMW | 535            | E28 | 84    | 88    |  | ✓ |
| BMW | 535 i          | E34 | 87    | 93    |  | ✓ |
| BMW | 540 i          | E34 | 92    | 96    |  | ✓ |
| BMW | 540 i Touring  | E34 | 93    | 96    |  | ✓ |
| BMW | 628 CSi Coupé  | E24 | 06/82 | 87    |  | ✓ |
| BMW | 635 CSi Coupé  | E24 | 06/82 | 89    |  | ✓ |
| BMW | 635 MCSi Coupé | E24 | 83    | 89    |  | ✓ |
| BMW | 728            | E23 | 10/81 | 86    |  | ✓ |
| BMW | 730 i          | E32 | 86    | 94    |  | ✓ |
| BMW | 732 i, 735     | E23 | 10/81 | 86    |  | ✓ |
| BMW | 733 i          | E23 | 10/81 | 82    |  | ✓ |
| BMW | 735 i          | E32 | 85    | 92    |  | ✓ |
| BMW | 735 iL         | E32 | 87    | 92    |  | ✓ |
| BMW | 740            | E32 | 01/91 | 94    |  | ✓ |
| BMW | 745 i          | E23 | 10/81 | 86    |  | ✓ |
| BMW | 750 i          | E32 | 87    | 94    |  | ✓ |
| BMW | 750 iL         | E32 | 86    | 94    |  | ✓ |
| BMW | M 5            | E28 | 84    | 95    |  | ✓ |

**502 072**



|     |                  |     |       |    |  |   |
|-----|------------------|-----|-------|----|--|---|
| BMW | 316              | E30 | 10/85 | 91 |  | ✓ |
| BMW | 316 i/5 Touring  | E30 | 91    | 94 |  | ✓ |
| BMW | 318 i            | E30 | 82    | 87 |  | ✓ |
| BMW | 318              | E30 | 87    | 91 |  | ✓ |
| BMW | 318 is           | E30 | 89    | 91 |  | ✓ |
| BMW | 318 ic Cabriolet | E30 | 90    | 93 |  | ✓ |
| BMW | 318 i/5 Touring  | E30 | 89    | 94 |  | ✓ |
| BMW | 320 i            | E30 | 10/85 | 91 |  | ✓ |
| BMW | 320 is           | E30 | 87    | 90 |  | ✓ |
| BMW | 320 ix           | E30 | 85    | 91 |  | ✓ |
| BMW | 320 i/5 Touring  | E30 | 88    | 91 |  | ✓ |
| BMW | 320 ic Cabriolet | E30 | 10/85 | 93 |  | ✓ |
| BMW | 323 i            | E30 | 10/85 | 86 |  | ✓ |
| BMW | 323 ti Compact   | E36 | 97    | 00 |  | ✓ |
| BMW | 324              | E30 | 85    | 90 |  | ✓ |
| BMW | 324 td/5 Touring | E30 | 81    | 93 |  | ✓ |
| BMW | 325 e            | E30 | 10/85 | 90 |  | ✓ |
| BMW | 325 i            | E30 | 85    | 91 |  | ✓ |
| BMW | 325 ic Cabriolet | E30 | 85    | 92 |  | ✓ |
| BMW | 325 i/5 Touring  | E30 | 87    | 93 |  | ✓ |
| BMW | 325 ix/5 Touring | E30 | 88    | 92 |  | ✓ |
| BMW | M 3              | E30 | 85    | 92 |  | ✓ |

**502 109**



|     |                        |     |       |    |  |   |
|-----|------------------------|-----|-------|----|--|---|
| BMW | Z 1                    |     | 10/90 | 91 |  | ✓ |
| BMW | Z 3 1.9                | E36 | 04/90 | 02 |  | ✓ |
| BMW | Z 3 2.0, 2.2, 2.8, 3.0 | E36 | 96    | 02 |  | ✓ |

**502 123**



|     |                                 |     |    |    |  |   |
|-----|---------------------------------|-----|----|----|--|---|
| BMW | 520 i, 520 i Touring            | E39 | 95 | 04 |  | ✓ |
| BMW | 520 d, 520 d Touring            | E39 | 00 | 04 |  | ✓ |
| BMW | 520 i                           | E60 | 03 | 06 |  | ✓ |
| BMW | 523 i, 523 i Touring            | E39 | 95 | 00 |  | ✓ |
| BMW | 525 i, 525 td, 525 tds          | E39 | 96 | 04 |  | ✓ |
| BMW | 525 i Touring, 525 d, d Touring | E39 | 00 | 04 |  | ✓ |
| BMW | 525 tds Touring                 | E39 | 97 | 04 |  | ✓ |

**502 123**



|     |                      |     |    |    |  |   |
|-----|----------------------|-----|----|----|--|---|
| BMW | 525 i                | E60 | 03 | 06 |  | ✓ |
| BMW | 525 d                | E60 | 04 | 06 |  | ✓ |
| BMW | 528 i, 528 i Touring | E39 | 95 | 01 |  | ✓ |
| BMW | 530 i, 530 i Touring | E39 | 00 | 04 |  | ✓ |
| BMW | 530 d                | E39 | 97 | 04 |  | ✓ |
| BMW | 530 d Touring        | E39 | 98 | 04 |  | ✓ |
| BMW | 530 i, d             | E60 | 03 | 06 |  | ✓ |
| BMW | 535 i                | E39 | 95 | 04 |  | ✓ |
| BMW | 535 d                | E60 | 04 | 06 |  | ✓ |
| BMW | 540 i                | E39 | 96 | 04 |  | ✓ |
| BMW | 540 i Touring        | E39 | 97 | 04 |  | ✓ |
| BMW | 545 i                | E60 | 03 | 06 |  | ✓ |
| BMW | M 5                  | E39 | 98 | 02 |  | ✓ |

**502 125**



|     |                 |     |    |       |  |   |
|-----|-----------------|-----|----|-------|--|---|
| BMW | 316 Compact     | E36 | 93 | 99    |  | ✓ |
| BMW | 318 i Compact   | E36 | 94 | 99    |  | ✓ |
| BMW | 318 tds Compact | E36 | 95 | 99    |  | ✓ |
| BMW | Z 3 1.8         | E36 | 94 | 98    |  | ✓ |
| BMW | Z 3 1.9         | E36 | 94 | 03/99 |  | ✓ |

**502 134**



|     |          |     |    |    |  |   |
|-----|----------|-----|----|----|--|---|
| BMW | 315      | E21 | 80 | 83 |  | ✓ |
| BMW | 316, 318 | E21 | 75 | 83 |  | ✓ |

**502 135**

|     |                            |     |    |    |    |   |
|-----|----------------------------|-----|----|----|----|---|
| BMW | 325 xi, 325 xi Touring     | E46 | 99 | 05 | ✓  | ✓ |
| BMW | 330 i, 330 i Touring       | E46 | 99 | 04 |    | ✓ |
| BMW | 330 Ci Cabriolet, Ci Coupé | E46 | 99 | 04 |    | ✓ |
| BMW | 330 Cd Coupé               | E46 | 03 | 04 |    | ✓ |
| BMW | 330 d                      | E46 | 99 | 04 |    | ✓ |
| BMW | 330 xi, 330 xi Touring     | E46 | 99 | 04 | ✓  | ✓ |
| BMW | 330 xd, 330 xd Touring     | E46 | 99 | 04 | ✓  | ✓ |
| BMW | 725 tds, 728 i, iL         | E38 | 95 | 01 |    | ✓ |
| BMW | 730 i, iL                  | E38 | 93 | 01 |    | ✓ |
| BMW | 730 d                      | E38 | 98 | 01 |    | ✓ |
| BMW | 735 i, iL, 750 i, iL       | E38 | 94 | 01 |    | ✓ |
| BMW | 740 i, iL                  | E38 | 95 | 01 |    | ✓ |
| BMW | 740 d                      | E38 | 99 | 01 |    | ✓ |
| BMW | 840 Coupé                  | E31 | 92 | 99 |    | ✓ |
| BMW | 850 i Coupé, 850 Ci Coupé  | E31 | 89 | 94 |    | ✓ |
| BMW | 850 Ci Coupé               | E31 | 94 | 99 |    | ✓ |
| BMW | 850 CSi Coupé              | E31 | 92 | 96 |    | ✓ |
| BMW | M 3                        | E36 | 92 | 99 |    | ✓ |
| BMW | X 3                        |     |    | 04 | 05 | ✓ |
| BMW | Z 3 3.2                    | E36 | 96 | 02 |    | ✓ |
| BMW | Z 8                        |     |    | 00 | 06 | ✓ |

**502 138**

|     |             |     |    |    |  |   |
|-----|-------------|-----|----|----|--|---|
| BMW | 316 i       | E36 | 90 | 94 |  | ✓ |
| BMW | 316 i       | E36 | 92 | 94 |  | ✓ |
| BMW | 316 i       | E36 | 93 | 98 |  | ✓ |
| BMW | 316 i Coupé | E36 | 93 | 99 |  | ✓ |
| BMW | 318 i       | E36 | 89 | 94 |  | ✓ |
| BMW | 318 i       | E36 | 92 | 94 |  | ✓ |
| BMW | 318 i       | E36 | 93 | 98 |  | ✓ |

**502 148**

|     |                |     |    |    |  |   |
|-----|----------------|-----|----|----|--|---|
| BMW | 316 i          | E36 | 90 | 91 |  | ✓ |
| BMW | 316 i          | E36 | 93 | 98 |  | ✓ |
| BMW | 316 i Coupé    | E36 | 93 | 99 |  | ✓ |
| BMW | 316 i Touring  | E36 | 96 | 99 |  | ✓ |
| BMW | 316 i          | E46 | 98 | 04 |  | ✓ |
| BMW | 316 i Touring  | E46 | 02 | 04 |  | ✓ |
| BMW | 316 Ci Coupé   | E46 | 98 | 04 |  | ✓ |
| BMW | 316 ti Compact | E46 | 01 | 04 |  | ✓ |
| BMW | 318 i          | E36 | 89 | 91 |  | ✓ |
| BMW | 318 i          | E36 | 93 | 98 |  | ✓ |
| BMW | 318 is         | E36 | 91 | 99 |  | ✓ |

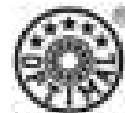

**502 148**



|     |                             |     |    |       |   |
|-----|-----------------------------|-----|----|-------|---|
| BMW | 318 i Cabriolet             | E36 | 92 | 99    | ✓ |
| BMW | 318 i Touring               | E36 | 95 | 99    | ✓ |
| BMW | 318 tds, tds Touring        | E36 | 94 | 99    | ✓ |
| BMW | 318 i                       | E46 | 97 | 05    | ✓ |
| BMW | 318 i Touring, Ci Coupé     | E46 | 99 | 05    | ✓ |
| BMW | 318 d, Ci Cabriolet         | E46 | 01 | 05    | ✓ |
| BMW | 318 td Compact              | E46 | 03 | 05    | ✓ |
| BMW | 318 ti Compact              | E46 | 01 | 05    | ✓ |
| BMW | 320 i, i Cabriolet          | E36 | 90 | 99    | ✓ |
| BMW | 320 i Coupé                 | E36 | 92 | 99    | ✓ |
| BMW | 320 i Touring               | E36 | 95 | 99    | ✓ |
| BMW | 320 i                       | E46 | 98 | 05    | ✓ |
| BMW | 320 i Touring, Ci Cabriolet | E46 | 00 | 05    | ✓ |
| BMW | 320 Ci Coupé                | E46 | 99 | 05    | ✓ |
| BMW | 320 Cd Coupé                | E46 | 03 | 05    | ✓ |
| BMW | 320 d                       | E46 | 98 | 05    | ✓ |
| BMW | 320 d Touring               | E46 | 00 | 05    | ✓ |
| BMW | 320 td Compact              | E46 | 01 | 05    | ✓ |
| BMW | 323 i                       | E36 | 94 | 99    | ✓ |
| BMW | 323 i                       | E46 | 97 | 04    | ✓ |
| BMW | 323 Ci Coupé                | E46 | 99 | 04    | ✓ |
| BMW | 325 i                       | E36 | 89 | 99    | ✓ |
| BMW | 325 i Cabriolet             | E36 | 93 | 99    | ✓ |
| BMW | 325 i Coupé                 | E36 | 92 | 99    | ✓ |
| BMW | 325 td                      | E36 | 91 | 99    | ✓ |
| BMW | 325 tds Touring             | E36 | 95 | 99    | ✓ |
| BMW | 325 i                       | E46 | 99 | 05    | ✓ |
| BMW | 325 i Touring               | E46 | 00 | 05    | ✓ |
| BMW | 325 Ci Coupé, Ci Cabriolet  | E46 | 00 | 05    | ✓ |
| BMW | 325 ti Compact              | E46 | 01 | 05    | ✓ |
| BMW | 328 i, i Cabriolet          | E36 | 95 | 99    | ✓ |
| BMW | 328 i Coupé, i Touring      | E36 | 95 | 99    | ✓ |
| BMW | 328 i, Ci Coupé, i Touring  | E46 | 97 | 01    | ✓ |
| BMW | Z 1                         |     | 88 | 09/90 | ✓ |
| BMW | Z 4 2.2i, 2.5i, 3.0i        |     | 03 | 06    | ✓ |

**502 163**



|      |                   |  |    |    |   |
|------|-------------------|--|----|----|---|
| MINI | Mini Cooper       |  | 01 | 05 | ✓ |
| MINI | Mini Cooper S     |  | 02 | 05 | ✓ |
| MINI | Mini One          |  | 00 | 05 | ✓ |
| MINI | Mini One D, Works |  | 03 | 05 | ✓ |

**502 178**



|     |               |     |       |       |   |
|-----|---------------|-----|-------|-------|---|
| BMW | 518, 528      | E12 | 74    | 81    | ✓ |
| BMW | 520           | E12 | 72    | 81    | ✓ |
| BMW | 525           | E12 | 73    | 81    | ✓ |
| BMW | 535 Mi        | E12 | 80    | 81    | ✓ |
| BMW | 628 CSi Coupé | E24 | 79    | 05/82 | ✓ |
| BMW | 630 CS Coupé  | E24 | 75    | 79    | ✓ |
| BMW | 633 CSi Coupé | E24 | 75    | 81    | ✓ |
| BMW | 635 CSi Coupé | E24 | 06/78 | 05/82 | ✓ |
| BMW | 728           | E23 | 77    | 09/81 | ✓ |
| BMW | 730           | E23 | 76    | 79    | ✓ |
| BMW | 732 i         | E23 | 79    | 09/81 | ✓ |
| BMW | 733 i         | E23 | 76    | 09/81 | ✓ |
| BMW | 735           | E23 | 79    | 09/81 | ✓ |
| BMW | 745 i         | E23 | 79    | 09/81 | ✓ |

**502 252**



|     |                              |          |    |       |   |
|-----|------------------------------|----------|----|-------|---|
| BMW | 520 i Touring, 525 i Touring | E61      | 04 | 06    | ✓ |
| BMW | 525 d Touring, 530 i Touring | E61      | 04 | 06    | ✓ |
| BMW | 530 d Touring, 535 d Touring | E61      | 04 | 06    | ✓ |
| BMW | 545 i Touring, 645 Ci Coupé  | E61      | 04 | 06    | ✓ |
| BMW | 645 Ci Cabriolet             | E64      | 04 | 06    | ✓ |
| BMW | 730 i, Li, 760 i, Li         | E65, E66 | 03 | 06    | ✓ |
| BMW | 730 d, 735 i, Li, 740 d      | E65, E66 | 01 | 06    | ✓ |
| BMW | 745 i, Li                    | E65, E66 | 01 | 06    | ✓ |
| BMW | X 5                          |          | 00 | 09/03 | ✓ |

**502 599**



|      |               |  |       |    |   |
|------|---------------|--|-------|----|---|
| MINI | Mini Cooper   |  | 11/06 | 06 | ✓ |
| MINI | Mini Cooper S |  | 11/06 | 05 | ✓ |

**502 629**



|     |                           |     |       |    |   |
|-----|---------------------------|-----|-------|----|---|
| BMW | 118 i, d, 120i            | E87 | 04    | 06 | ✓ |
| BMW | 318 i, d                  | E90 | 09/05 | 06 | ✓ |
| BMW | 320 i, d, 325 i, 330 i, d | E90 | 01/05 | 06 | ✓ |
| BMW | 320 i Touring, d Touring  | E91 | 01/05 | 06 | ✓ |
| BMW | 325 i Touring, i Touring  | E91 | 01/05 | 06 | ✓ |
| BMW | 330 d Touring             | E91 | 01/05 | 06 | ✓ |

**600 308**



|         |                                       |        |       |       |   |
|---------|---------------------------------------|--------|-------|-------|---|
| CITROËN | Berlingo                              |        | 96    | 05    | ✓ |
| CITROËN | Berlingo 4x4                          |        | 97    | 04    | ✓ |
| CITROËN | Berlingo Electrique SA18              |        | 96    | 04    | ✓ |
| CITROËN | BX                                    |        | 09/84 | 94    | ✓ |
| CITROËN | BX 4x4                                |        | 88    | 93    | ✓ |
| CITROËN | Xantia                                |        | 93    | 05    | ✓ |
| CITROËN | Xsara 1.4, 1.5 D, 1.6                 | Front  | 97    | 05    | ✓ |
| CITROËN | Xsara 1.8i, 1.8 D/TD, 1.9 D/TD        | Front  | 97    | 05    | ✓ |
| CITROËN | Xsara 2.0 16V                         | Front  | 97    | 05    | ✓ |
| CITROËN | Xsara 2.0 Hdi                         | Front  | 98    | 05    | ✓ |
| CITROËN | Xsara Picasso                         |        | 99    | 05    | ✓ |
| CITROËN | ZX 1.1, 1.4, 1.6, 1.7 Diesel, 1.8     |        | 91    | 98    | ✓ |
| CITROËN | ZX 1.9 Diesel, 1.9 Turbo Diesel, 2.0  |        | 91    | 98    | ✓ |
| DACIA   | Nova                                  |        | 98    | 02    | ✓ |
| PEUGEOT | 205 1.6, 1.6 GTI                      |        | 85    | 98    | ✓ |
| PEUGEOT | 205 1.7 D, 1.7 TD                     |        | 85    | 00    | ✓ |
| PEUGEOT | 205 1.8 Diesel, 1.8 Turbo Diesel, 1.9 |        | 85    | 98    | ✓ |
| PEUGEOT | 205 1.9 GTI                           |        | 87    | 98    | ✓ |
| PEUGEOT | 205 1.9 Diesel                        |        | 85    | 98    | ✓ |
| PEUGEOT | 206 1.6 16V                           |        | 99    | 05    | ✓ |
| PEUGEOT | 206 1.6 HDi                           |        | 04    | 05    | ✓ |
| PEUGEOT | 206 2.0 S16, 2.0 16V                  |        | 00    | 05    | ✓ |
| PEUGEOT | 206 2.0 RC                            |        | 03    | 05    | ✓ |
| PEUGEOT | 206 2.0 HDi                           |        | 99    | 05    | ✓ |
| PEUGEOT | 206 Cabriolet                         |        | 99    | 05    | ✓ |
| PEUGEOT | 305                                   |        | 09/84 | 91    | ✓ |
| PEUGEOT | 306 I                                 |        | 93    | 97    | ✓ |
| PEUGEOT | 306 I Entreprise                      |        | 93    | 97    | ✓ |
| PEUGEOT | 306 II 1.1, 1.4                       | Front  | 97    | 04    | ✓ |
| PEUGEOT | 306 II 1.6                            | Front  | 97    | 04    | ✓ |
| PEUGEOT | 306 II 1.8, 1.8 D, 1.9 D/TD, 2.0      | Front  | 97    | 04    | ✓ |
| PEUGEOT | 306 II 2.0 Hdi                        | Front  | 98    | 04    | ✓ |
| PEUGEOT | 309 1.1                               | 1124cc | 86    | 89    | ✓ |
| PEUGEOT | 309 1.4                               | 1360cc | 86    | 89    | ✓ |
| PEUGEOT | 309 1.4                               | 1442cc | 86    | 93    | ✓ |
| PEUGEOT | 309 1.5, 1.6                          |        | 86    | 93    | ✓ |
| PEUGEOT | 309 1.6 GTI                           |        | 87    | 93    | ✓ |
| PEUGEOT | 309 1.8 Diesel, 1.8 Turbo Diesel      |        | 89    | 93    | ✓ |
| PEUGEOT | 309 1.9                               |        | 86    | 93    | ✓ |
| PEUGEOT | 309 1.9 GTI, 1.9 Diesel               |        | 87    | 93    | ✓ |
| PEUGEOT | 309 1.9 Turbo Diesel                  |        | 87    | 93    | ✓ |
| PEUGEOT | 405                                   |        | 87    | 96    | ✓ |
| PEUGEOT | 405 4x4                               |        | 89    | 96    | ✓ |
| PEUGEOT | 406 I                                 |        | 95    | 03/99 | ✓ |
| PEUGEOT | 406 II                                |        | 03/99 | 03    | ✓ |
| PEUGEOT | Partner                               |        | 96    | 05    | ✓ |

**600 334**



|         |                  |  |    |       |   |
|---------|------------------|--|----|-------|---|
| CITROËN | AX 10, AX 11     |  | 87 | 98    | ✓ |
| CITROËN | AX 13 Sport      |  | 87 | 91    | ✓ |
| CITROËN | AX 14            |  | 87 | 04/91 | ✓ |
| CITROËN | AX 14 Diesel     |  | 89 | 04/91 | ✓ |
| CITROËN | AX 14 4x4        |  | 91 | 97    | ✓ |
| CITROËN | AX 14 GT, 14 GTI |  | 89 | 04/91 | ✓ |
| CITROËN | Saxo 1.0i        |  | 96 | 09/99 | ✓ |
| CITROËN | Saxo 1.1i        |  | 96 | 09/99 | ✓ |

**600 334**

|         |                            |    |       |   |  |
|---------|----------------------------|----|-------|---|--|
| CITROËN | Saxo 1.0i, 1.1i Entreprise | 96 | 07/97 | ✓ |  |
| PEUGEOT | 106 1.0, 1.1               | 91 | 02    | ✓ |  |

**600 410**

|        |              |    |    |  |   |
|--------|--------------|----|----|--|---|
| TALBOT | 1100         | 78 | 81 |  | ✓ |
| TALBOT | 1510         | 80 | 84 |  | ✓ |
| TALBOT | Alpine       | 80 | 84 |  | ✓ |
| TALBOT | Horizon      | 78 | 86 |  | ✓ |
| TALBOT | Matra-Rancho | 78 | 84 |  | ✓ |
| TALBOT | Minx         | 85 | 86 |  | ✓ |
| TALBOT | Solara       | 81 | 86 |  | ✓ |

**601 253**

|         |                  |       |       |       |   |
|---------|------------------|-------|-------|-------|---|
| CITROËN | C 2, C 3         | Front | 02    | 06    | ✓ |
| PEUGEOT | 1007             | Front | 04/05 | 12/05 | ✓ |
| PEUGEOT | 207 1.4, 1.4 16V |       | 02/06 | 12/06 | ✓ |

**601 306**

|         |  |         |       |       |   |
|---------|--|---------|-------|-------|---|
| CITROËN | AX 14                                  |         | 04/91 | 96    | ✓ |
| CITROËN | AX 14 Diesel                           |         | 04/91 | 95    | ✓ |
| CITROËN | AX 14 4x4                              |         | 91    | 97    | ✓ |
| CITROËN | AX 14 GT, GTI                          |         | 04/91 | 97    | ✓ |
| CITROËN | AX 15 Diesel                           |         | 95    | 97    | ✓ |
| CITROËN | C 15 1.0, 1.4                          |         | 05/88 | 98    | ✓ |
| CITROËN | C 15 1.1                               | 1118ccm | 85    | 98    | ✓ |
| CITROËN | C 15 1.1                               | 1124ccm | 05/88 | 98    | ✓ |
| CITROËN | C 15 1.3, 1.8 Diesel                   |         | 85    | 88    | ✓ |
| CITROËN | C 15 1.9 Diesel                        |         | 00    | 02    | ✓ |
| CITROËN | Saxo 1.0i, 1.1i Entreprise             |         | 96    | 01/99 | ✓ |
| CITROËN | Saxo 1.1i, 1.4i, Saxo 1.5 Diesel, 1.6i |         | 96    | 01/99 | ✓ |
| CITROËN | Saxo SA13 Electrique                   |         | 97    | 01/99 | ✓ |
| CITROËN | Visa 1.6 GTI, 1.7 Diesel               |         | 85    | 89    | ✓ |
| CITROËN | Xsara 1.4, 1.5 D, 1.6                  | Front   | 97    | 01/99 | ✓ |
| CITROËN | ZX ZX 1.1, 1.4, 1.4 Diesel, 1.5 Diesel |         | 91    | 98    | ✓ |
| DACIA   | Nova                                   |         | 98    | 02    | ✓ |
| PEUGEOT | 106 1.0, 1.1                           |         | 91    | 01/99 | ✓ |
| PEUGEOT | 106 1.3                                |         | 91    | 96    | ✓ |
| PEUGEOT | 106 1.4                                |         | 91    | 01/99 | ✓ |
| PEUGEOT | 106 1.4 Diesel                         |         | 92    | 96    | ✓ |
| PEUGEOT | 106 1.5 Diesel                         |         | 94    | 01/99 | ✓ |
| PEUGEOT | 106 1.6                                |         | 94    | 02    | ✓ |
| PEUGEOT | 106 SA13 Electrique                    |         | 97    | 02    | ✓ |
| PEUGEOT | 205 1.0, 1.1, 1.2, 1.3, 1.4, 1.5       |         | 83    | 98    | ✓ |
| PEUGEOT | 205 1.6, 1.6 GTI                       |         | 85    | 98    | ✓ |
| PEUGEOT | 205 1.7 D, 1.7 TD                      |         | 85    | 00    | ✓ |
| PEUGEOT | 205 1.8 Diesel, 1.8 Turbo Diesel       |         | 85    | 98    | ✓ |
| PEUGEOT | 205 1.9, 205 1.9 Diesel                |         | 85    | 98    | ✓ |
| PEUGEOT | 306 I, I Entreprise                    |         | 93    | 97    | ✓ |
| PEUGEOT | 306 II 1.1, 1.4                        | Front   | 97    | 01/99 | ✓ |
| PEUGEOT | 309 1.1                                | 1118cc  | 86    | 93    | ✓ |
| PEUGEOT | 309 1.1                                | 1124cc  | 90    | 93    | ✓ |
| PEUGEOT | 309 1.3                                |         | 86    | 93    | ✓ |
| PEUGEOT | 309 1.4                                | 1360cc  | 90    | 93    | ✓ |

**601 323**

|         |     |  |       |    |   |
|---------|-----|--|-------|----|---|
| CITROËN | XM  |  | 04/97 | 00 | ✓ |
| PEUGEOT | 605 |  | 05/97 | 99 | ✓ |
| PEUGEOT | 607 |  | 00    | 03 | ✓ |

**601 336**

|         |     |  |    |       |   |
|---------|-----|--|----|-------|---|
| CITROËN | BX  |  | 83 | 08/84 | ✓ |
| PEUGEOT | 305 |  | 83 | 08/84 | ✓ |

**601 348**

|         |     |  |    |       |   |
|---------|-----|--|----|-------|---|
| CITROËN | XM  |  | 89 | 04/97 | ✓ |
| PEUGEOT | 605 |  | 90 | 04/97 | ✓ |

**601 384**

|         |                           |  |    |    |   |
|---------|---------------------------|--|----|----|---|
| PEUGEOT | 504 Berline GL, L, GR, SR |  | 76 | 85 | ✓ |
|---------|---------------------------|--|----|----|---|

**601 384**

|         |                                   |    |    |   |  |
|---------|-----------------------------------|----|----|---|--|
| PEUGEOT | 504 Break, Commerciale, Familiale | 76 | 85 | ✓ |  |
| PEUGEOT | 504 Cabriolet, Coupé              | 76 | 84 | ✓ |  |
| PEUGEOT | 505 Berline                       | 79 | 92 | ✓ |  |
| PEUGEOT | 505 Break, Familiale              | 82 | 92 | ✓ |  |
| PEUGEOT | 604                               | 75 | 87 | ✓ |  |
| PEUGEOT | 504 Camionnette                   | 80 | 90 | ✓ |  |
| TALBOT  | Tagora                            | 81 | 83 | ✓ |  |

**601 396**

|         |                    |         |       |       |   |
|---------|--------------------|---------|-------|-------|---|
| CITROËN | C 15 1.0, 1.4      |         | 85    | 05/88 | ✓ |
| CITROËN | C 15 1.1           | 1124ccm | 85    | 05/88 | ✓ |
| CITROËN | LNA                |         | 07/80 | 86    | ✓ |
| CITROËN | Visa               |         | 07/80 | 84    | ✓ |
| CITROËN | Visa 0.6, 1.1, 1.4 |         | 85    | 91    | ✓ |
| CITROËN | Visa 1.0           |         | 85    | 89    | ✓ |
| PEUGEOT | 104                |         | 07/80 | 88    | ✓ |
| TALBOT  | Samba              |         | 82    | 86    | ✓ |

**601 434**

|         |    |  |       |    |   |
|---------|----|--|-------|----|---|
| CITROËN | CX |  | 03/82 | 92 | ✓ |
|---------|----|--|-------|----|---|

**601 440**

|         |            |  |    |    |   |
|---------|------------|--|----|----|---|
| CITROËN | 2 CV 6     |  | 70 | 91 | ✓ |
| CITROËN | Dyane 6    |  | 80 | 83 | ✓ |
| CITROËN | Méhari 4x2 |  | 68 | 87 | ✓ |
| CITROËN | Méhari 4x4 |  | 79 | 83 | ✓ |

**601 446**

|        |              |  |    |    |   |
|--------|--------------|--|----|----|---|
| TALBOT | 1100         |  | 78 | 81 | ✓ |
| TALBOT | 1510, Alpine |  | 80 | 84 | ✓ |
| TALBOT | Horizon      |  | 78 | 86 | ✓ |
| TALBOT | Matra-Rancho |  | 78 | 84 | ✓ |
| TALBOT | Minx         |  | 85 | 86 | ✓ |
| TALBOT | Solara       |  | 81 | 86 | ✓ |

**601 495**

|         |     |  |       |    |   |
|---------|-----|--|-------|----|---|
| PEUGEOT | 304 |  | 09/72 | 80 | ✓ |
| PEUGEOT | 305 |  | 78    | 82 | ✓ |

**601 502**

|         |     |  |       |    |   |
|---------|-----|--|-------|----|---|
| CITROËN | GSA |  | 04/81 | 86 | ✓ |
|---------|-----|--|-------|----|---|

**601 580**

|         |     |  |       |    |   |
|---------|-----|--|-------|----|---|
| PEUGEOT | J 7 |  | 10/70 | 80 | ✓ |
| PEUGEOT | J 9 |  | 80    | 91 | ✓ |

**601 654**

|         |     |  |       |    |   |
|---------|-----|--|-------|----|---|
| PEUGEOT | 104 |  | 07/80 | 88 | ✓ |
|---------|-----|--|-------|----|---|

**601 675**

|         |                         |  |       |       |   |
|---------|-------------------------|--|-------|-------|---|
| CITROËN | C 6 2.7 Hdi             |  | 06/06 | 12/06 | ✓ |
| CITROËN | C 6 2.2 Hdi, 3.0 V6 24V |  | 09/05 | 06    | ✓ |
| PEUGEOT | 407 Coupé               |  | 04    | 06    | ✓ |
| PEUGEOT | 407, 407 SW, 607        |  | 05    | 06    | ✓ |

**601 834**

|         |                  |  |       |       |   |
|---------|------------------|--|-------|-------|---|
| CITROËN | C 1              |  | 06/05 | 12/06 | ✓ |
| PEUGEOT | 107 1.0, 1.4 HDi |  | 06/05 | 12/06 | ✓ |
| TOYOTA  | Aygo             |  | 07/05 | 06    | ✓ |

**601 916**

|         |  |       |       |       |   |
|---------|--|-------|-------|-------|---|
| CITROËN | C 2, C 3                               | Front | 02    | 06    | ✓ |
| CITROËN | Saxo 1.0i                              |       | 10/99 | 04    | ✓ |
| CITROËN | Saxo 1.1i, 1.0i, 1.1i Entreprise, 1.4i |       | 02/99 | 04    | ✓ |
| CITROËN | Saxo 1.5 Diesel, 1.6i, SA13 Electrique |       | 02/99 | 04    | ✓ |
| CITROËN | Xsara 1.4, 1.5 D, 1.6                  | Front | 01/99 | 09/00 | ✓ |
| PEUGEOT | 106 1.0, 1.1, 1.4, 1.5 Diesel, 1.6     |       | 02/99 | 02    | ✓ |
| PEUGEOT | 1007                                   | Front | 04/05 | 12/05 | ✓ |
| PEUGEOT | 206 1.1i, 1.4i                         |       | 01/98 | 09/98 | ✓ |
| PEUGEOT | 206 1.1i, 1.4i, 1.4 HDi                |       | 09/98 | 05    | ✓ |

**601 916**

|         |                    |       |       |    |   |
|---------|--------------------|-------|-------|----|---|
| PEUGEOT | 206 1.4 HDi eco 70 | 01    | 05    | ✓  |   |
| PEUGEOT | 206 1.6i           | 01/98 | 05    | ✓  |   |
| PEUGEOT | 206 1.9 Diesel     | 01/98 | 01    | ✓  |   |
| PEUGEOT | 306 II 1.1, 1.4    | Front | 02/99 | 04 | ✓ |

**601 953**

|         |                                |       |       |   |  |
|---------|--------------------------------|-------|-------|---|--|
| CITROËN | C 4                            | 03    | 12/06 | ✓ |  |
| CITROËN | C 4 Picasso                    | 09/06 | 12/06 | ✓ |  |
| CITROËN | C 5, C 5 Break                 | 01    | 06    | ✓ |  |
| PEUGEOT | 207 1.4 HDi, 1.6 16 V, 1.6 HDi | 02/06 | 12/06 | ✓ |  |
| PEUGEOT | 307                            | 00    | 05    | ✓ |  |
| PEUGEOT | 307 SW                         | 02    | 05    | ✓ |  |

**602 249**

|         |                            |    |       |   |  |
|---------|----------------------------|----|-------|---|--|
| PEUGEOT | 206 1.1i, 1.4i, 1.4 HDi    | 98 | 09/02 | ✓ |  |
| PEUGEOT | 206 1.6 16V, 206 Cabriolet | 99 | 09/02 | ✓ |  |
| PEUGEOT | 206 2.0 S16, 2.0 16V       | 00 | 09/02 | ✓ |  |

**602 251**

|         |                                  |       |       |       |   |
|---------|----------------------------------|-------|-------|-------|---|
| CITROËN | C 2, C 3                         | Rear  | 02    | 06    | ✓ |
| PEUGEOT | 1007                             | Rear  | 04/05 | 12/05 | ✓ |
| PEUGEOT | 206 1.1i, 1.4i, 1.4 HDi, 1.6 16V | 09/02 | 05    | ✓     |   |
| PEUGEOT | 206 1.6 HDi                      | 04    | 05    | ✓     |   |
| PEUGEOT | 206 2.0 S16, 2.0 16V             | 09/02 | 03    | ✓     |   |
| PEUGEOT | 206 2.0 RC                       | 03    | 05    | ✓     |   |
| PEUGEOT | 206 2.0 HDi                      | 99    | 05    | ✓     |   |
| PEUGEOT | 206 Cabriolet                    | 09/02 | 05    | ✓     |   |

**602 314**

|         |                                 |      |    |       |   |
|---------|---------------------------------|------|----|-------|---|
| CITROËN | Xsara 1.8i, 1.8 D/TD, 1.9 D/TD  | Rear | 97 | 09/98 | ✓ |
| CITROËN | Xsara 2.0i 16V, Break           | Rear | 97 | 09/98 | ✓ |
| CITROËN | ZX 1.1, 1.4, 1.6, 1.8, 2.0      |      | 91 | 98    | ✓ |
| CITROËN | ZX 1.4 Diesel, 1.5 Diesel       |      | 91 | 98    | ✓ |
| CITROËN | ZX 1.7 Diesel                   |      | 91 | 98    | ✓ |
| CITROËN | ZX 1.9 Diesel, 1.9 Turbo Diesel |      | 91 | 98    | ✓ |
| PEUGEOT | 205 1.6, 1.6 GTI, 1.9           |      | 85 | 98    | ✓ |
| PEUGEOT | 205 1.9 GTI                     |      | 87 | 98    | ✓ |
| PEUGEOT | 306 I                           |      | 93 | 97    | ✓ |
| PEUGEOT | 306 II                          | Rear | 97 | 09/98 | ✓ |

**602 320**

|         |                                   |        |       |       |   |
|---------|-----------------------------------|--------|-------|-------|---|
| CITROËN | AX 14 GTI                         | 89     | 97    | ✓     |   |
| CITROËN | Saxo 1.0i, 1.0i Entreprise        | 96     | 01/99 | ✓     |   |
| CITROËN | Saxo 1.1i, 1.1i Entreprise        | 96     | 01/99 | ✓     |   |
| CITROËN | Saxo 1.4i, 1.5 Diesel, 1.6i       | 96     | 01/99 | ✓     |   |
| CITROËN | Saxo SA13 Electrique              | 97     | 01/99 | ✓     |   |
| CITROËN | Visa 1.6 GTI, 1.7 Diesel          | 85     | 89    | ✓     |   |
| CITROËN | Xsara                             | Rear   | 97    | 09/98 | ✓ |
| CITROËN | ZX 1.1, 1.4, 1.6, 1.8, 2.0        |        | 91    | 98    | ✓ |
| CITROËN | ZX 1.4 Diesel, 1.5 Diesel         |        | 91    | 98    | ✓ |
| CITROËN | ZX 1.7 Diesel                     |        | 91    | 98    | ✓ |
| CITROËN | ZX 1.9 Diesel, 1.9 Turbo Diesel   |        | 91    | 98    | ✓ |
| DACIA   | Nova                              |        | 98    | 02    | ✓ |
| PEUGEOT | 106 1.0, 1.1, 1.4                 |        | 91    | 01/99 | ✓ |
| PEUGEOT | 106 1.3                           |        | 91    | 96    | ✓ |
| PEUGEOT | 106 1.4 Diesel                    |        | 92    | 96    | ✓ |
| PEUGEOT | 106 1.5 Diesel, 1.6               |        | 94    | 01/99 | ✓ |
| PEUGEOT | 106 SA13 Electrique               |        | 97    | 01/99 | ✓ |
| PEUGEOT | 205 1.0, 1.1, 1.2, 1.3, 1.4, 1.5  |        | 83    | 98    | ✓ |
| PEUGEOT | 205 1.6, 1.6 GTI, 1.9, 1.9 Diesel |        | 85    | 98    | ✓ |
| PEUGEOT | 205 1.7 D, 1.7 TD                 |        | 85    | 00    | ✓ |
| PEUGEOT | 205 1.8 Diesel, 1.8 Turbo Diesel  |        | 85    | 98    | ✓ |
| PEUGEOT | 206 1.1i, 1.4i, 1.6i, 1.9 Diesel  |        | 01/98 | 09/98 | ✓ |
| PEUGEOT | 306 I, I Entreprise               |        | 93    | 97    | ✓ |
| PEUGEOT | 306 II 1.1, 1.4, 1.6              | Rear   | 97    | 09/98 | ✓ |
| PEUGEOT | 306 II 1.8, 1.8 D, 1.9 D/TD, 2.0  | Rear   | 97    | 09/98 | ✓ |
| PEUGEOT | 309 1.1                           | 1118cc | 86    | 93    | ✓ |
| PEUGEOT | 309 1.1                           | 1124cc | 86    | 93    | ✓ |
| PEUGEOT | 309 1.3                           |        | 86    | 93    | ✓ |

**602 320**

|         |                                  |                |    |    |   |
|---------|----------------------------------|----------------|----|----|---|
| PEUGEOT | 309 1.4                          | 1360cc, 1442cc | 86 | 93 | ✓ |
| PEUGEOT | 309 1.5, 1.6                     |                | 86 | 93 | ✓ |
| PEUGEOT | 309 1.8 Diesel, 1.8 Turbo Diesel |                | 89 | 93 | ✓ |
| PEUGEOT | 309 1.9                          |                | 86 | 93 | ✓ |
| PEUGEOT | 309 1.9 Diesel, 1.9 Turbo Diesel |                | 87 | 93 | ✓ |

**602 322**

|         |                 |  |    |       |   |
|---------|-----------------|--|----|-------|---|
| CITROËN | AX 10, AX 11    |  | 87 | 98    | ✓ |
| CITROËN | AX 13 Sport     |  | 87 | 91    | ✓ |
| CITROËN | AX 14           |  | 87 | 96    | ✓ |
| CITROËN | AX 14 Diesel    |  | 89 | 95    | ✓ |
| CITROËN | AX 14 GT        |  | 89 | 97    | ✓ |
| CITROËN | AX 15 Diesel    |  | 95 | 97    | ✓ |
| CITROËN | Saxo 1.0i, 1.1i |  | 96 | 01/99 | ✓ |
| PEUGEOT | 106 1.0, 1.1    |  | 91 | 01/99 | ✓ |

**602 337**

|         |                                    |  |       |       |   |
|---------|------------------------------------|--|-------|-------|---|
| CITROËN | Berlingo, Berlingo Electrique SA18 |  | 96    | 04    | ✓ |
| CITROËN | Xantia                             |  | 06/95 | 05    | ✓ |
| CITROËN | Xsara Picasso                      |  | 99    | 05    | ✓ |
| PEUGEOT | 406 I                              |  | 95    | 03/99 | ✓ |
| PEUGEOT | Partner                            |  | 96    | 04    | ✓ |

**602 338**

|         |                      |  |    |    |   |
|---------|----------------------|--|----|----|---|
| PEUGEOT | 205 1.9 GTI          |  | 87 | 98 | ✓ |
| PEUGEOT | 309 1.6 GTI, 1.6 GTI |  | 87 | 93 | ✓ |

**602 339**

|         |               |  |       |    |   |
|---------|---------------|--|-------|----|---|
| CITROËN | Xantia        |  | 06/95 | 05 | ✓ |
| CITROËN | Xsara Picasso |  | 99    | 04 | ✓ |
| PEUGEOT | 406 II        |  | 03/99 | 03 | ✓ |

**602 340**

|         |                      |         |       |       |   |
|---------|----------------------|---------|-------|-------|---|
| CITROËN | BX                   |         | 83    | 94    | ✓ |
| CITROËN | C 15 1.0, 1.4        |         | 05/88 | 98    | ✓ |
| CITROËN | C 15 1.1             | 1118ccm | 85    | 98    | ✓ |
| CITROËN | C 15 1.1             | 1124ccm | 05/88 | 98    | ✓ |
| CITROËN | C 15 1.3, 1.8 Diesel |         | 85    | 88    | ✓ |
| CITROËN | C 15 1.9 Diesel      |         | 00    | 02    | ✓ |
| CITROËN | Xantia               |         | 93    | 06/95 | ✓ |
| PEUGEOT | 305                  |         | 83    | 08/84 | ✓ |
| PEUGEOT | 305                  |         | 09/84 | 91    | ✓ |
| PEUGEOT | 405                  |         | 87    | 96    | ✓ |

**602 341**

|         |        |  |    |       |   |
|---------|--------|--|----|-------|---|
| CITROËN | Xantia |  | 93 | 06/95 | ✓ |
|---------|--------|--|----|-------|---|

**602 343**

|         |     |  |    |    |   |
|---------|-----|--|----|----|---|
| PEUGEOT | 405 |  | 87 | 96 | ✓ |
|---------|-----|--|----|----|---|

**602 344**

|         |     |  |    |    |   |
|---------|-----|--|----|----|---|
| PEUGEOT | 605 |  | 90 | 99 | ✓ |
|---------|-----|--|----|----|---|

**602 345**

|         |                                  |  |    |    |   |
|---------|----------------------------------|--|----|----|---|
| CITROËN | Berlingo, Xsara Picasso, Partner |  | 96 | 04 | ✓ |
|---------|----------------------------------|--|----|----|---|

**602 347**

|         |           |  |    |    |   |
|---------|-----------|--|----|----|---|
| CITROËN | Saxo 1.6i |  | 96 | 04 | ✓ |
| PEUGEOT | 106 1.6   |  | 94 | 02 | ✓ |

**602 349**

|         |           |  |    |    |   |
|---------|-----------|--|----|----|---|
| CITROËN | Saxo 1.6i |  | 96 | 04 | ✓ |
| PEUGEOT | 106 1.6   |  | 94 | 02 | ✓ |

**602 356**

|         |    |  |    |    |   |
|---------|----|--|----|----|---|
| CITROËN | XM |  | 89 | 00 | ✓ |
|---------|----|--|----|----|---|

**602 358**

|         |    |  |       |    |   |
|---------|----|--|-------|----|---|
| CITROËN | CX |  | 03/82 | 92 | ✓ |
|---------|----|--|-------|----|---|

**602 361**

|         |                                 |      |    |       |   |
|---------|---------------------------------|------|----|-------|---|
| CITROËN | Xsara Break                     | Rear | 97 | 09/98 | ✓ |
| CITROËN | ZX 1.1, 1.4, 1.6, 1.8, 2.0      |      | 91 | 98    | ✓ |
| CITROËN | ZX 1.4 Diesel, 1.5 Diesel       |      | 91 | 98    | ✓ |
| CITROËN | ZX 1.7 Diesel                   |      | 91 | 98    | ✓ |
| CITROËN | ZX 1.9 Diesel, 1.9 Turbo Diesel |      | 91 | 98    | ✓ |
| PEUGEOT | 306 I                           |      | 93 | 06/95 | ✓ |
| PEUGEOT | 306 I Entreprise                |      | 93 | 97    | ✓ |
| PEUGEOT | 306 II, II Entreprise           | Rear | 97 | 09/98 | ✓ |

**602 367**

|         |       |  |    |       |   |
|---------|-------|--|----|-------|---|
| PEUGEOT | 406 I |  | 95 | 03/99 | ✓ |
|---------|-------|--|----|-------|---|

**602 369**

|         |     |  |    |    |   |
|---------|-----|--|----|----|---|
| PEUGEOT | 605 |  | 90 | 99 | ✓ |
|---------|-----|--|----|----|---|

**602 386**

|         |                                  |      |       |    |   |
|---------|----------------------------------|------|-------|----|---|
| CITROËN | Xsara 1.8i, 1.8 D/TD, 1.9 D/TD   | Rear | 10/98 | 05 | ✓ |
| CITROËN | Xsara 2.0i 16V                   | Rear | 10/98 | 05 | ✓ |
| CITROËN | Xsara 2.0 Hdi                    | Rear | 98    | 05 | ✓ |
| CITROËN | Xsara Break                      | Rear | 10/98 | 05 | ✓ |
| PEUGEOT | 306 II 1.8, 1.8 D, 1.9 D/TD, 2.0 | Rear | 10/98 | 04 | ✓ |
| PEUGEOT | 306 II 2.0 Hdi                   | Rear | 98    | 04 | ✓ |
| PEUGEOT | 306 II                           | Rear | 10/98 | 04 | ✓ |

**602 388**

|         |     |  |       |       |   |
|---------|-----|--|-------|-------|---|
| CITROËN | BX  |  | 83    | 08/84 | ✓ |
| CITROËN | BX  |  | 09/84 | 94    | ✓ |
| PEUGEOT | 405 |  | 87    | 96    | ✓ |

**602 390**

|         |                      |  |    |    |   |
|---------|----------------------|--|----|----|---|
| PEUGEOT | 504 Cabriolet, Coupé |  | 81 | 84 | ✓ |
| PEUGEOT | 505 Berline          |  | 81 | 92 | ✓ |
| PEUGEOT | 604                  |  | 81 | 87 | ✓ |
| TALBOT  | Tagora               |  | 81 | 83 | ✓ |

**602 392**

|         |    |  |       |    |   |
|---------|----|--|-------|----|---|
| CITROËN | CX |  | 03/82 | 92 | ✓ |
|---------|----|--|-------|----|---|

**602 406**

|         |                          |  |    |    |   |
|---------|--------------------------|--|----|----|---|
| PEUGEOT | 504 Berline GL           |  | 76 | 85 | ✓ |
| PEUGEOT | 504 Cabriolet, 504 Coupé |  | 76 | 81 | ✓ |
| PEUGEOT | 505 Berline              |  | 79 | 80 | ✓ |
| PEUGEOT | 604                      |  | 75 | 80 | ✓ |

**602 412**

|         |                       |  |    |    |   |
|---------|-----------------------|--|----|----|---|
| PEUGEOT | 504 Berline L, GR, SR |  | 76 | 85 | ✓ |
|---------|-----------------------|--|----|----|---|

**602 414**

|         |                    |  |       |    |   |
|---------|--------------------|--|-------|----|---|
| CITROËN | LNA                |  | 07/80 | 86 | ✓ |
| CITROËN | Visa               |  | 07/80 | 84 | ✓ |
| CITROËN | Visa 0.6, 1.1, 1.4 |  | 85    | 91 | ✓ |
| CITROËN | Visa 1.0           |  | 85    | 89 | ✓ |
| PEUGEOT | 104                |  | 07/80 | 88 | ✓ |
| TALBOT  | Samba              |  | 82    | 86 | ✓ |

**602 416**

|         |     |  |    |    |   |
|---------|-----|--|----|----|---|
| CITROËN | GS  |  | 70 | 80 | ✓ |
| CITROËN | GSA |  | 79 | 86 | ✓ |

**602 418**

|         |            |  |    |    |   |
|---------|------------|--|----|----|---|
| CITROËN | 2 CV 6     |  | 70 | 91 | ✓ |
| CITROËN | Dyane 6    |  | 80 | 83 | ✓ |
| CITROËN | Méhari 4x2 |  | 68 | 87 | ✓ |

**602 430**

|                |                      |  |    |    |   |
|----------------|----------------------|--|----|----|---|
| CITROËN        | C 25 4x4             |  | 86 | 92 | ✓ |
| PEUGEOT        | 505 Break, Familiale |  | 82 | 92 | ✓ |
| PEUGEOT        | 504 Camionnette      |  | 82 | 90 | ✓ |
| PEUGEOT        | J 5 4x4              |  | 86 | 92 | ✓ |
| TALBOT-EXPRESS | J 5 4x4              |  | 86 | 90 | ✓ |

**602 512**

|         |             |  |    |    |   |
|---------|-------------|--|----|----|---|
| CITROËN | Axel/Oltcit |  | 84 | 90 | ✓ |
|---------|-------------|--|----|----|---|

**602 539**

|         |                            |  |    |    |   |
|---------|----------------------------|--|----|----|---|
| PEUGEOT | 504 Break                  |  | 81 | 85 | ✓ |
| PEUGEOT | 504 Commerciale, Familiale |  | 81 | 85 | ✓ |
| PEUGEOT | 504 Camionnette            |  | 80 | 81 | ✓ |

**602 541**

|         |     |  |       |    |   |
|---------|-----|--|-------|----|---|
| PEUGEOT | 304 |  | 09/72 | 80 | ✓ |
|---------|-----|--|-------|----|---|

**602 584**

|         |     |  |       |    |   |
|---------|-----|--|-------|----|---|
| PEUGEOT | J 7 |  | 10/70 | 80 | ✓ |
| PEUGEOT | J 9 |  | 80    | 91 | ✓ |

**602 645**

|         |                       |      |       |    |   |
|---------|-----------------------|------|-------|----|---|
| CITROËN | Xsara Break           | Rear | 10/98 | 05 | ✓ |
| PEUGEOT | 306 II, II Entreprise | Rear | 10/98 | 04 | ✓ |

**602 669**

|         |          |      |       |       |   |
|---------|----------|------|-------|-------|---|
| CITROËN | C 2, C 3 | Rear | 02    | 06    | ✓ |
| PEUGEOT | 1007     | Rear | 04/05 | 12/05 | ✓ |

**602 681**

|         |                         |  |       |       |   |
|---------|-------------------------|--|-------|-------|---|
| CITROËN | C 6 2.2 Hdi, 3.0 V6 24V |  | 09/05 | 06    | ✓ |
| CITROËN | C 6 2.7 Hdi             |  | 06/06 | 12/06 | ✓ |
| PEUGEOT | 407, 407 SW             |  | 04    | 06    | ✓ |
| PEUGEOT | 607                     |  | 04    | 05    | ✓ |

**602 835**

|         |                  |  |       |       |   |
|---------|------------------|--|-------|-------|---|
| CITROËN | C 1              |  | 06/05 | 12/06 | ✓ |
| PEUGEOT | 107 1.0, 1.4 HDi |  | 06/05 | 12/06 | ✓ |
| TOYOTA  | Aygo             |  | 07/05 | 06    | ✓ |

**602 858**

|         |                                    |      |       |    |   |
|---------|------------------------------------|------|-------|----|---|
| CITROËN | Saxo 1.0i, 1.0i Entreprise         |      | 02/99 | 04 | ✓ |
| CITROËN | Saxo 1.1i, 1.1i Entreprise         |      | 02/99 | 04 | ✓ |
| CITROËN | Saxo 1.4i, 1.5 Diesel, 1.6i        |      | 02/99 | 04 | ✓ |
| CITROËN | Saxo SA13 Electrique               |      | 02/99 | 04 | ✓ |
| CITROËN | Xsara                              | Rear | 10/98 | 05 | ✓ |
| PEUGEOT | 106 1.0, 1.1, 1.4, 1.5 Diesel, 1.6 |      | 02/99 | 02 | ✓ |
| PEUGEOT | 106 SA13 Electrique                |      | 02/99 | 02 | ✓ |
| PEUGEOT | 206 1.1i, 1.4i, 1.4 HDi, 1.6i      |      | 09/98 | 05 | ✓ |
| PEUGEOT | 206 1.4 HDi eco 70                 |      | 01    | 05 | ✓ |
| PEUGEOT | 206 1.6 16V                        |      | 99    | 05 | ✓ |
| PEUGEOT | 206 1.6 HDi                        |      | 04    | 05 | ✓ |
| PEUGEOT | 206 1.9 Diesel                     |      | 09/98 | 01 | ✓ |
| PEUGEOT | 206 2.0 S16, 2.0 16V               |      | 00    | 05 | ✓ |
| PEUGEOT | 206 2.0 HDi                        |      | 99    | 05 | ✓ |
| PEUGEOT | 306 II 1.1, 1.4, 1.6               | Rear | 10/98 | 04 | ✓ |
| PEUGEOT | 306 II 1.8, 1.8 D, 1.9 D/TD, 2.0   | Rear | 10/98 | 04 | ✓ |
| PEUGEOT | 306 II 2.0 Hdi                     | Rear | 98    | 04 | ✓ |

**602 859**

|         |     |  |    |    |   |
|---------|-----|--|----|----|---|
| PEUGEOT | 305 |  | 78 | 82 | ✓ |
|---------|-----|--|----|----|---|

**602 865**

|         |            |  |    |    |   |
|---------|------------|--|----|----|---|
| CITROËN | Méhari 4x4 |  | 79 | 83 | ✓ |
|---------|------------|--|----|----|---|

**602 881**

|        |        |  |    |    |   |
|--------|--------|--|----|----|---|
| TALBOT | Rapier |  | 85 | 86 | ✓ |
|--------|--------|--|----|----|---|

**602 893**

|         |             |  |       |       |   |
|---------|-------------|--|-------|-------|---|
| CITROËN | C 4         |  | 03    | 08/06 | ✓ |
| PEUGEOT | 307, 307 SW |  | 01/04 | 05    | ✓ |

**602 926**

|         |                 |  |       |       |   |
|---------|-----------------|--|-------|-------|---|
| CITROËN | Saxo 1.0i, 1.1i |  | 02/99 | 09/99 | ✓ |
| PEUGEOT | 106 1.0, 1.1    |  | 02/99 | 02    | ✓ |

**602 927**

|         |     |  |    |    |   |
|---------|-----|--|----|----|---|
| PEUGEOT | 607 |  | 00 | 03 | ✓ |
|---------|-----|--|----|----|---|



**602 937**

|         |     |    |    |   |
|---------|-----|----|----|---|
| PEUGEOT | 605 | 90 | 99 | ✓ |
|---------|-----|----|----|---|

**602 955**

|         |                |    |    |   |
|---------|----------------|----|----|---|
| CITROËN | C 5, C 5 Break | 01 | 06 | ✓ |
|---------|----------------|----|----|---|

**602 956**

|         |        |    |       |   |
|---------|--------|----|-------|---|
| PEUGEOT | 307    | 00 | 02/04 | ✓ |
| PEUGEOT | 307 SW | 02 | 02/03 | ✓ |

**681 259**

|         |                      |       |    |   |
|---------|----------------------|-------|----|---|
| CITROËN | C 8 3.0 V6 24V       | 02    | 06 | ✓ |
| FIAT    | Ulysse II 3.0 V6 24V | 08/02 | 05 | ✓ |
| LANCIA  | Phedra 3.0 V6 24V    | 02    | 05 | ✓ |
| PEUGEOT | 807 3.0i V6 24V      | 01    | 05 | ✓ |

**681 261**

|         |                                  |       |    |   |
|---------|----------------------------------|-------|----|---|
| CITROËN | C 8 2.0, 2.0 Hdi, 2.2, 2.2 Hdi   | 02    | 06 | ✓ |
| FIAT    | Ulysse II 2.0, 2.0 JTD           | 08/02 | 05 | ✓ |
| LANCIA  | Phedra 2.0 16V, 2.0 JTD, 2.2 JTD | 02    | 05 | ✓ |
| PEUGEOT | 807 2.0i 16V, 2.0 Hdi            | 01    | 05 | ✓ |
| PEUGEOT | 807 2.2i 16V, 2.2 Hdi            | 01    | 05 | ✓ |

**681 303**

|         |          |    |       |   |
|---------|----------|----|-------|---|
| CITROËN | Evasion  | 94 | 02    | ✓ |
| CITROËN | Jumpy    | 95 | 06    | ✓ |
| FIAT    | Scudo    | 94 | 06    | ✓ |
| FIAT    | Ulysse I | 94 | 07/02 | ✓ |
| LANCIA  | Zeta     | 95 | 02    | ✓ |
| PEUGEOT | 806      | 95 | 02    | ✓ |
| PEUGEOT | Expert   | 96 | 04    | ✓ |

**681 325**

|         |                    |       |       |   |
|---------|--------------------|-------|-------|---|
| CITROËN | Jumper 1800 kg     | 94    | 04/02 | ✓ |
| CITROËN | Jumper 1800 kg 4x4 | 96    | 04/02 | ✓ |
| FIAT    | Ducato II 18       | 03/94 | 04/02 | ✓ |
| FIAT    | Ducato II 18 4x4   | 96    | 04/02 | ✓ |
| PEUGEOT | Boxer 1800 kg      | 94    | 04/02 | ✓ |
| PEUGEOT | Boxer 1800 kg 4x4  | 96    | 04/06 | ✓ |

**681 375**

|         |                                 |       |       |   |
|---------|---------------------------------|-------|-------|---|
| CITROËN | Jumper 1000 kg, 1000 kg 4x4     | 04/02 | 04/06 | ✓ |
| CITROËN | Jumper 1400 kg, 1400 kg 4x4     | 04/02 | 04/06 | ✓ |
| FIAT    | Ducato III 1000 kg, 1000 kg 4x4 | 04/02 | 04/06 | ✓ |
| FIAT    | Ducato III 1500 kg, 1500 kg 4x4 | 04/02 | 04/06 | ✓ |
| PEUGEOT | Boxer 1000 kg, 1000 kg 4x4      | 04/02 | 04/06 | ✓ |
| PEUGEOT | Boxer 1400 kg, 1400 kg 4x4      | 04/02 | 04/06 | ✓ |

**681 471**

|         |                                 |       |       |   |
|---------|---------------------------------|-------|-------|---|
| CITROËN | Jumper 1800 kg, 1800 kg 4x4     | 04/02 | 04/06 | ✓ |
| FIAT    | Ducato III 1800 kg, 1800 kg 4x4 | 04/02 | 04/06 | ✓ |
| PEUGEOT | Boxer 1800 kg                   | 04/02 | 04/04 | ✓ |

**681 504**

|                |                       |    |    |   |
|----------------|-----------------------|----|----|---|
| CITROËN        | C 25 1000 kg          | 82 | 89 | ✓ |
| CITROËN        | C 25 1300 kg          | 82 | 87 | ✓ |
| CITROËN        | C 25 1400 kg          | 87 | 89 | ✓ |
| CITROËN        | C 25 1800 kg          | 86 | 89 | ✓ |
| CITROËN        | C 25 4x4              | 86 | 89 | ✓ |
| FIAT           | Ducato I 10, 14, 18   | 82 | 89 | ✓ |
| FIAT           | Ducato I 13           | 82 | 86 | ✓ |
| PEUGEOT        | J 5 1000 kg / 1300 kg | 82 | 89 | ✓ |
| PEUGEOT        | J 5 1400 kg           | 88 | 89 | ✓ |
| PEUGEOT        | J 5 1800 kg           | 82 | 89 | ✓ |
| PEUGEOT        | J 5 4x4               | 86 | 89 | ✓ |
| TALBOT-EXPRESS | J 5 1000/1300 kg      | 82 | 89 | ✓ |
| TALBOT-EXPRESS | J 5 1400 kg           | 89 | 90 | ✓ |
| TALBOT-EXPRESS | J 5 1800 kg           | 82 | 89 | ✓ |
| TALBOT-EXPRESS | J 5 4x4               | 86 | 89 | ✓ |

**681 506**

|                |  |       |       |   |
|----------------|--|-------|-------|---|
| CITROËN        | C 25 1000 kg, 1400 kg, 1800 kg         | 89    | 94    | ✓ |
| CITROËN        | C 25 4x4                               | 89    | 92    | ✓ |
| CITROËN        | Jumper 1000 kg                         | 94    | 04/02 | ✓ |
| CITROËN        | Jumper 1000 kg 4x4                     | 96    | 04/02 | ✓ |
| CITROËN        | Jumper 1400 kg                         | 94    | 04/02 | ✓ |
| CITROËN        | Jumper 1400 kg 4x4                     | 96    | 04/02 | ✓ |
| CITROËN        | Jumper 1800 kg 4x4                     | 96    | 04/02 | ✓ |
| FIAT           | Ducato I 10, 14, 18                    | 89    | 03/94 | ✓ |
| FIAT           | Ducato II 10                           | 03/94 | 04/02 | ✓ |
| FIAT           | Ducato II 10 4x4                       | 96    | 04/02 | ✓ |
| FIAT           | Ducato II 14                           | 03/94 | 04/02 | ✓ |
| FIAT           | Ducato II 14 4x4                       | 96    | 04/02 | ✓ |
| FIAT           | Ducato II 18 4x4                       | 96    | 04/02 | ✓ |
| FIAT           | Talento                                | 89    | 94    | ✓ |
| PEUGEOT        | Boxer 1000 kg                          | 94    | 04/02 | ✓ |
| PEUGEOT        | Boxer 1000 kg 4x4                      | 96    | 04/02 | ✓ |
| PEUGEOT        | Boxer 1400 kg                          | 94    | 04/02 | ✓ |
| PEUGEOT        | Boxer 1400 kg 4x4                      | 96    | 04/02 | ✓ |
| PEUGEOT        | Boxer 1800 kg 4x4                      | 96    | 04/02 | ✓ |
| PEUGEOT        | J 5 1000 kg, 1300 kg, 1400 kg, 1800 kg | 89    | 92    | ✓ |
| PEUGEOT        | J 5 4x4                                | 89    | 92    | ✓ |
| TALBOT-EXPRESS | J 5 1000 kg, 1300 kg, 1400 kg, 1800 kg | 89    | 90    | ✓ |
| TALBOT-EXPRESS | J 5 4x4                                | 89    | 90    | ✓ |

**681 640**

|         |      |    |    |   |
|---------|------|----|----|---|
| CITROËN | C 35 | 73 | 92 | ✓ |
| IVECO   | 242  | 74 | 82 | ✓ |

**681 907**

|             |                                     |       |       |   |
|-------------|-------------------------------------|-------|-------|---|
| LEYLAND-DAF | Leyland-Daf 200                     | 04/89 | 91    | ✓ |
| LEYLAND-DAF | Leyland-Daf 400 Ser.                | 89    | 91    | ✓ |
| LEYLAND-DAF | Sherpa 200, 230, 250, 255, 280 (K2) | 83    | 04/89 | ✓ |
| LEYLAND-DAF | Sherpa 285, 310, 350 (MT210)        | 84    | 85    | ✓ |
| LEYLAND-DAF | Sherpa 285, 300, 310, 350           | 85    | 89    | ✓ |

**681 909**

|       |                                  |       |       |   |
|-------|----------------------------------|-------|-------|---|
| IVECO | Daily I 35-12 Turbodayly         | 81    | 02/96 | ✓ |
| IVECO | Daily I 45-10, 49-10             | 85    | 88    | ✓ |
| IVECO | Daily I 49-12 Turbodayly         | 85    | 02/96 | ✓ |
| IVECO | Grinta Ser S Turbo: 45-10, 49-10 | 03/85 | 88    | ✓ |

**681 910**

|       |                                  |       |       |   |
|-------|----------------------------------|-------|-------|---|
| IVECO | Daily I 35-12 Turbodayly         | 81    | 02/96 | ✓ |
| IVECO | Daily I 45-10, 49-10             | 85    | 88    | ✓ |
| IVECO | Daily I 49-12 Turbodayly         | 85    | 02/96 | ✓ |
| IVECO | Grinta Ser S Turbo: 45-10, 49-10 | 03/85 | 88    | ✓ |

**681 923**

|       |                          |       |    |   |
|-------|--------------------------|-------|----|---|
| IVECO | Daily I 35-8             | 03/96 | 99 | ✓ |
| IVECO | Daily I 35-10 Turbodayly | 96    | 99 | ✓ |
| IVECO | Daily I 35-12 Turbodayly | 03/96 | 99 | ✓ |
| IVECO | Daily I 49-10 Turbodayly | 96    | 99 | ✓ |
| IVECO | Daily I 49-12 Turbodayly | 03/96 | 99 | ✓ |
| IVECO | Daily II                 | 05/99 | 05 | ✓ |

**681 924**

|       |                          |    |    |   |
|-------|--------------------------|----|----|---|
| IVECO | Daily I 59-12 Turbodayly | 91 | 99 | ✓ |
|-------|--------------------------|----|----|---|

**682 169**

|                   |                   |    |    |   |
|-------------------|-------------------|----|----|---|
| POLSKI FIAT / FSO | FSO Polonez TRUCK | 97 | 00 | ✓ |
|-------------------|-------------------|----|----|---|

**682 175**

|        |           |    |    |   |
|--------|-----------|----|----|---|
| DAEWOO | Lublin II | 97 | 03 | ✓ |
|--------|-----------|----|----|---|

**682 263**

|         |                                  |       |    |   |
|---------|----------------------------------|-------|----|---|
| CITROËN | C 8 2.0, 2.0 Hdi, 2.2, 2.2 Hdi   | 02    | 06 | ✓ |
| CITROËN | C 8 3.0 V6 24V                   | 02    | 06 | ✓ |
| FIAT    | Ulysse II 2.0, 2.0 JTD, 2.2 JTD  | 08/02 | 05 | ✓ |
| FIAT    | Ulysse II 3.0 V6 24V             | 08/02 | 05 | ✓ |
| LANCIA  | Phedra 2.0 16V, 2.0 JTD, 2.2 JTD | 02    | 05 | ✓ |

**682 263**

|         |  |    |    |  |   |
|---------|--|----|----|--|---|
| LANCIA  | Phedra 3.0 V6 24V                        | 02 | 05 |  | ✓ |
| PEUGEOT | 807 2.0i 16V, 2.0 Hdi, 2.2i 16V, 2.2 Hdi | 01 | 05 |  | ✓ |
| PEUGEOT | 807 3.0i V6 24V                          | 01 | 05 |  | ✓ |

**682 305**

|         |          |    |       |  |   |
|---------|----------|----|-------|--|---|
| CITROËN | Evasion  | 94 | 02    |  | ✓ |
| CITROËN | Jumpy    | 95 | 06    |  | ✓ |
| FIAT    | Scudo    | 94 | 06    |  | ✓ |
| FIAT    | Ulysse I | 94 | 07/02 |  | ✓ |
| LANCIA  | Zeta     | 95 | 02    |  | ✓ |
| PEUGEOT | 806      | 95 | 02    |  | ✓ |
| PEUGEOT | Expert   | 96 | 04    |  | ✓ |

**682 327**

|         |                         |       |       |  |   |
|---------|-------------------------|-------|-------|--|---|
| CITROËN | Jumper 1000 kg, 1400 kg | 94    | 04/02 |  | ✓ |
| FIAT    | Ducato II 10, 14        | 03/94 | 04/02 |  | ✓ |
| PEUGEOT | Boxer 1000 kg, 1400 kg  | 94    | 04/02 |  | ✓ |

**682 329**

|         |                |       |       |  |   |
|---------|----------------|-------|-------|--|---|
| CITROËN | Jumper 1800 kg | 94    | 04/02 |  | ✓ |
| FIAT    | Ducato II 18   | 03/94 | 04/02 |  | ✓ |
| PEUGEOT | Boxer 1800 kg  | 94    | 04/02 |  | ✓ |

**682 420**

|                |                       |    |    |  |   |
|----------------|-----------------------|----|----|--|---|
| CITROËN        | C 25 1000 kg, 1300 kg | 82 | 86 |  | ✓ |
| FIAT           | Ducato I 10, 13       | 82 | 86 |  | ✓ |
| PEUGEOT        | J 5 1000 kg, 1300 kg  | 82 | 85 |  | ✓ |
| TALBOT-EXPRESS | J 5 1000 kg, 1300 kg  | 82 | 85 |  | ✓ |

**682 422**

|                |                       |    |    |  |   |
|----------------|-----------------------|----|----|--|---|
| CITROËN        | C 25 1000 kg          | 82 | 86 |  | ✓ |
| CITROËN        | C 25 1300 kg          | 82 | 87 |  | ✓ |
| FIAT           | Ducato I 10           | 82 | 86 |  | ✓ |
| FIAT           | Ducato I 13           | 82 | 86 |  | ✓ |
| PEUGEOT        | J 5 1000 kg / 1300 kg | 82 | 85 |  | ✓ |
| TALBOT-EXPRESS | J 5 1000/1300 kg      | 82 | 85 |  | ✓ |

**682 437**

|         |                                      |       |       |  |   |
|---------|--------------------------------------|-------|-------|--|---|
| CITROËN | Jumper 1000 kg, 1400 kg, 1800 kg     | 04/02 | 04/06 |  | ✓ |
| FIAT    | Ducato III 1000 kg, 1500 kg, 1800 kg | 04/02 | 04/06 |  | ✓ |
| PEUGEOT | Boxer 1000 kg, 1400 kg, 1800 kg      | 04/02 | 04/06 |  | ✓ |

**682 490**

|                |              |    |    |  |   |
|----------------|--------------|----|----|--|---|
| CITROËN        | C 25 1800 kg | 86 | 94 |  | ✓ |
| FIAT           | Ducato I 18  | 86 | 94 |  | ✓ |
| PEUGEOT        | J 5 1800 kg  | 82 | 92 |  | ✓ |
| TALBOT-EXPRESS | J 5 1800 kg  | 82 | 90 |  | ✓ |

**682 492**

|                |              |    |    |  |   |
|----------------|--------------|----|----|--|---|
| CITROËN        | C 25 1800 kg | 86 | 94 |  | ✓ |
| FIAT           | Ducato I 18  | 86 | 94 |  | ✓ |
| PEUGEOT        | J 5 1800 kg  | 82 | 92 |  | ✓ |
| TALBOT-EXPRESS | J 5 1800 kg  | 82 | 92 |  | ✓ |

**682 508**

|                |                      |    |       |  |   |
|----------------|----------------------|----|-------|--|---|
| CITROËN        | C 25 1000 kg         | 86 | 94    |  | ✓ |
| CITROËN        | C 25 1300 kg         | 87 | 87    |  | ✓ |
| CITROËN        | C 25 1400 kg         | 87 | 94    |  | ✓ |
| FIAT           | Ducato I 10, 14      | 86 | 03/94 |  | ✓ |
| FIAT           | Ducato I 13          | 86 | 86    |  | ✓ |
| FIAT           | Talento              | 89 | 94    |  | ✓ |
| PEUGEOT        | J 5 1000 kg, 1300 kg | 86 | 92    |  | ✓ |
| PEUGEOT        | J 5 1400 kg          | 88 | 92    |  | ✓ |
| TALBOT-EXPRESS | J 5 1000 kg, 1300 kg | 86 | 90    |  | ✓ |
| TALBOT-EXPRESS | J 5 1400 kg          | 89 | 90    |  | ✓ |

**682 510**

|         |                       |    |    |  |   |
|---------|-----------------------|----|----|--|---|
| CITROËN | C 25 1000 kg, 1400 kg | 86 | 94 |  | ✓ |
| CITROËN | C 25 1300 kg          | 87 | 87 |  | ✓ |
| CITROËN | C 25 1400 kg          | 87 | 94 |  | ✓ |

**682 510**

|                |                      |    |       |  |   |
|----------------|----------------------|----|-------|--|---|
| FIAT           | Ducato I 10, 14      | 86 | 03/94 |  | ✓ |
| FIAT           | Ducato I 13          | 86 | 86    |  | ✓ |
| FIAT           | Talento              | 89 | 94    |  | ✓ |
| PEUGEOT        | J 5 1000 kg, 1300 kg | 86 | 92    |  | ✓ |
| PEUGEOT        | J 5 1400 kg          | 88 | 92    |  | ✓ |
| TALBOT-EXPRESS | J 5 1000/1300 kg     | 86 | 90    |  | ✓ |
| TALBOT-EXPRESS | J 5 1400 kg          | 89 | 90    |  | ✓ |

**682 642**

|         |      |    |    |  |   |
|---------|------|----|----|--|---|
| CITROËN | C 35 | 73 | 92 |  | ✓ |
| IVECO   | 242  | 74 | 82 |  | ✓ |

**682 848**

|                   |                   |    |    |  |   |
|-------------------|-------------------|----|----|--|---|
| POLSKI FIAT / FSO | FSO Polonez TRUCK | 94 | 97 |  | ✓ |
|-------------------|-------------------|----|----|--|---|

**682 867**

|                   |                   |    |    |  |   |
|-------------------|-------------------|----|----|--|---|
| POLSKI FIAT / FSO | FSO Polonez CARGO | 96 | 00 |  | ✓ |
|-------------------|-------------------|----|----|--|---|

**682 920**

|             |                              |    |    |  |   |
|-------------|------------------------------|----|----|--|---|
| LEYLAND-DAF | Leyland-Daf 400 Ser.         | 89 | 91 |  | ✓ |
| LEYLAND-DAF | Sherpa 285, 310, 350 (MT210) | 83 | 85 |  | ✓ |
| LEYLAND-DAF | Sherpa 285, 300, 310, 350    | 85 | 89 |  | ✓ |

**682 925**

|       |                          |       |    |  |   |
|-------|--------------------------|-------|----|--|---|
| IVECO | Daily I 35-8             | 03/96 | 99 |  | ✓ |
| IVECO | Daily I 35-10 Turbodayly | 96    | 99 |  | ✓ |
| IVECO | Daily I 35-12 Turbodayly | 03/96 | 99 |  | ✓ |
| IVECO | Daily I 49-10 Turbodayly | 96    | 99 |  | ✓ |
| IVECO | Daily I 49-12 Turbodayly | 03/96 | 99 |  | ✓ |
| IVECO | Daily II                 | 05/99 | 05 |  | ✓ |

**700 245**

|         |                           |    |    |   |   |
|---------|---------------------------|----|----|---|---|
| RENAULT | Kangoo 4x4                | 01 | 05 | ✓ | ✓ |
| RENAULT | Megane Scenic I RX4 (JA_) | 97 | 04 | ✓ | ✓ |

**700 310**

|         |                          |       |       |   |  |
|---------|--------------------------|-------|-------|---|--|
| DACIA   | Logan 1.4, 1.6           | 04    | 06    | ✓ |  |
| DACIA   | Logan 1.5 dCi            | 09/05 | 06    | ✓ |  |
| RENAULT | Clio I (B57A)            | 94    | 04/97 | ✓ |  |
| RENAULT | Clio I (B57B, I, T)      | 93    | 98    | ✓ |  |
| RENAULT | Clio I (B57B/S)          | 05/97 | 98    | ✓ |  |
| RENAULT | Clio I (B57J)            | 96    | 98    | ✓ |  |
| RENAULT | Clio I (B57J/INITIALE,S) | 05/97 | 98    | ✓ |  |
| RENAULT | Clio I (B57S)            | 94    | 96    | ✓ |  |
| RENAULT | Clio I (B57Y)            | 94    | 04/97 | ✓ |  |
| RENAULT | Clio I (B578)            | 94    | 98    | ✓ |  |
| RENAULT | Clio I (557A, D, G, J)   | 94    | 98    | ✓ |  |
| RENAULT | Clio I (557B, W)         | 05/97 | 98    | ✓ |  |
| RENAULT | Clio I (557K, R, Y)      | 96    | 04/97 | ✓ |  |
| RENAULT | Clio I (557N, 557U)      | 96    | 98    | ✓ |  |
| RENAULT | Clio I (C57A)            | 94    | 04/97 | ✓ |  |
| RENAULT | Clio I (C57B)            | 93    | 04/97 | ✓ |  |
| RENAULT | Clio I (C57B, C)         | 05/97 | 98    | ✓ |  |
| RENAULT | Clio I (C57B/RTI,S)      | 05/97 | 98    | ✓ |  |
| RENAULT | Clio I (C57D)            | 91    | 96    | ✓ |  |
| RENAULT | Clio I (C57H)            | 94    | 98    | ✓ |  |
| RENAULT | Clio I (C57I)            | 93    | 98    | ✓ |  |
| RENAULT | Clio I (C57J)            | 96    | 98    | ✓ |  |
| RENAULT | Clio I (C57J/RTI,S)      | 05/97 | 98    | ✓ |  |
| RENAULT | Clio I (C57M, S)         | 94    | 96    | ✓ |  |
| RENAULT | Clio I (C57T)            | 93    | 96    | ✓ |  |
| RENAULT | Clio I (C57Y)            | 94    | 04/97 | ✓ |  |
| RENAULT | Clio I (C57Y/RTI)        | 05/97 | 98    | ✓ |  |
| RENAULT | Clio I (C575)            | 90    | 96    | ✓ |  |
| RENAULT | Clio I (C578)            | 94    | 98    | ✓ |  |
| RENAULT | Clio I (C579)            | 93    | 96    | ✓ |  |
| RENAULT | Clio I (S57I)            | 93    | 98    | ✓ |  |
| RENAULT | Clio I (357A)            | 94    | 98    | ✓ |  |
| RENAULT | Clio I (357D, E, G, J)   | 94    | 96    | ✓ |  |

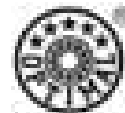

**700 310**



|         |                    |                                     |       |       |   |   |
|---------|--------------------|-------------------------------------|-------|-------|---|---|
| RENAULT | Clio I             | (357K, R, Y)                        | 96    | 04/97 | ✓ |   |
| RENAULT | Clio I             | (357N, U, V)                        | 96    | 98    | ✓ |   |
| RENAULT | Clio I             | (657H, M, N)                        | 96    | 98    | ✓ |   |
| RENAULT | Clio I             | (657W)                              | 05/97 | 98    | ✓ |   |
| RENAULT | Clio II            |                                     | 98    | 05    | ✓ |   |
| RENAULT | Espace I 2.0 4x4   | (J112, S112)                        | 85    | 90    |   | ✓ |
| RENAULT | Espace I 2.2 4x4   | (J116, J117)                        | 87    | 90    |   | ✓ |
| RENAULT | Kangoo             |                                     | 98    | 05    | ✓ |   |
| RENAULT | Laguna I           | Front                               | 93    | 98    | ✓ |   |
| RENAULT | Megane I Hatchback | 1.4, 1.6, 1.8 (BA_)                 | 95    | 04    | ✓ |   |
| RENAULT | Megane I Hatchback | 1.9 D, dT (BA_)                     | 95    | 04    | ✓ |   |
| RENAULT | Megane I Hatchback | 1.9 dTi, dCi (BA_)                  | 95    | 04    | ✓ |   |
| RENAULT | Megane I Hatchback | 2.0i (BA_)                          | 95    | 04    | ✓ |   |
| RENAULT | Megane I Hatchback | 2.0 16V (BA0H)                      | 10/98 | 04    | ✓ |   |
| RENAULT | Megane I Grandtour | (KA0_)                              | 98    | 04    | ✓ |   |
| RENAULT | Megane I Cabriolet | 1.4, 1.6, 2.0 (EA_)                 | 95    | 02    | ✓ |   |
| RENAULT | Megane I Cabriolet | 2.0 16V (EA0H)                      | 10/98 | 02    | ✓ |   |
| RENAULT | Megane I Classic   | (LA_)                               | 95    | 04    | ✓ |   |
| RENAULT | Megane I Coupé     | 1.4, 1.6, 2.0i (DA_)                | 95    | 02    | ✓ |   |
| RENAULT | Megane I Coupé     | 1.9 dTi, dCi (DA_)                  | 95    | 02    | ✓ |   |
| RENAULT | Megane I Coupé     | 2.0 16V (DA0H)                      | 10/98 | 02    | ✓ |   |
| RENAULT | Megane Scenic I    | 1.4 (JA0E)                          | 97    | 09/99 | ✓ |   |
| RENAULT | Megane Scenic I    | 1.4, 1.6 (JA_)                      | 09/99 | 04    | ✓ |   |
| RENAULT | Megane Scenic I    | 1.6 (JA04)                          | 07/98 | 04    | ✓ |   |
| RENAULT | Megane Scenic I    | 1.6 (JA0F)                          | 97    | 98    | ✓ |   |
| RENAULT | Megane Scenic I    | 1.6 (JA0F)                          | 07/98 | 09/99 | ✓ |   |
| RENAULT | Megane Scenic I    | 1.6 (JA0L)                          | 97    | 98    | ✓ |   |
| RENAULT | Megane Scenic I    | 1.8 16V (JA_)                       | 01    | 04    | ✓ |   |
| RENAULT | Megane Scenic I    | 1.9 D, dT (JA_)                     | 07/98 | 09/99 | ✓ |   |
| RENAULT | Megane Scenic I    | 1.9 dTi, dCi (JA_)                  | 09/99 | 04    | ✓ |   |
| RENAULT | Megane Scenic I    | 1.9 dTi, 2.0 (JA_)                  | 07/98 | 09/99 | ✓ |   |
| RENAULT | Megane Scenic I    | 2.0 (JA_)                           | 09/99 | 04    | ✓ |   |
| RENAULT | R 5 Express        | 1.4                                 | 09/91 | 98    | ✓ |   |
| RENAULT | R 5 Express        | 1.6 Diesel                          | 86    | 98    | ✓ |   |
| RENAULT | R 5 Express        | 1.9 Diesel                          | 91    | 98    | ✓ |   |
| RENAULT | R 19               | 1.7, 1.8, 1.8 16V                   | 88    | 95    | ✓ |   |
| RENAULT | R 19               | 1.9 Diesel, 1.9 Turbo Diesel        | 88    | 95    | ✓ |   |
| RENAULT | R 21               | 1.9 Diesel (B48..., K48..., S48...) | 88    | 94    | ✓ |   |
| RENAULT | R 21               | 2.0 (B48J, K48J, L48J)              | 89    | 94    | ✓ |   |
| RENAULT | Thalia             | 1.2 16V, 1.6 16V                    | 02    | 06    | ✓ |   |
| RENAULT | Thalia             | 1.4 16V                             | 00    | 06    | ✓ |   |
| RENAULT | Thalia             | 1.5 dCi                             | 01    | 06    | ✓ |   |

**701 247**



|         |           |  |       |    |   |  |
|---------|-----------|--|-------|----|---|--|
| RENAULT | Espace IV |  | 11/02 | 06 | ✓ |  |
| RENAULT | Vel Satis |  | 02    | 06 | ✓ |  |

**701 302**



|         |        |                    |       |       |   |  |
|---------|--------|--------------------|-------|-------|---|--|
| DACIA   | Duster |                    | 84    | 93    | ✓ |  |
| RENAULT | Clio I | (B57A)             | 91    | 98    | ✓ |  |
| RENAULT | Clio I | (B57B)             | 90    | 04/97 | ✓ |  |
| RENAULT | Clio I | (B57B/RL,RN,RT)    | 05/97 | 98    | ✓ |  |
| RENAULT | Clio I | (B57C)             | 91    | 04/97 | ✓ |  |
| RENAULT | Clio I | (B57J)             | 96    | 04/97 | ✓ |  |
| RENAULT | Clio I | (B57J/RN,RT,RL)    | 05/97 | 98    | ✓ |  |
| RENAULT | Clio I | (B57R, T)          | 91    | 96    | ✓ |  |
| RENAULT | Clio I | (B57S, Y)          | 94    | 96    | ✓ |  |
| RENAULT | Clio I | (B57U)             | 92    | 96    | ✓ |  |
| RENAULT | Clio I | (B571, B572, B573) | 90    | 96    | ✓ |  |
| RENAULT | Clio I | (B574)             | 91    | 96    | ✓ |  |
| RENAULT | Clio I | (B577)             | 94    | 96    | ✓ |  |
| RENAULT | Clio I | (557B)             | 94    | 04/97 | ✓ |  |
| RENAULT | Clio I | (557F, G, J, L)    | 94    | 96    | ✓ |  |
| RENAULT | Clio I | (557K, R)          | 96    | 98    | ✓ |  |
| RENAULT | Clio I | (557U, Y)          | 96    | 04/97 | ✓ |  |
| RENAULT | Clio I | (557W)             | 95    | 04/97 | ✓ |  |
| RENAULT | Clio I | (557Y)             | 05/97 | 98    | ✓ |  |
| RENAULT | Clio I | (C57A, R)          | 91    | 98    | ✓ |  |

**701 302**



|         |             |                     |       |       |   |  |
|---------|-------------|---------------------|-------|-------|---|--|
| RENAULT | Clio I      | (C57B)              | 90    | 04/97 | ✓ |  |
| RENAULT | Clio I      | (C57B/RN,RT)        | 05/97 | 98    | ✓ |  |
| RENAULT | Clio I      | (C57C)              | 92    | 04/97 | ✓ |  |
| RENAULT | Clio I      | (C57H)              | 94    | 04/97 | ✓ |  |
| RENAULT | Clio I      | (C57J)              | 96    | 04/97 | ✓ |  |
| RENAULT | Clio I      | (C57J/RL,RT)        | 05/97 | 98    | ✓ |  |
| RENAULT | Clio I      | (C57S)              | 94    | 96    | ✓ |  |
| RENAULT | Clio I      | (C57T)              | 91    | 96    | ✓ |  |
| RENAULT | Clio I      | (C57U)              | 92    | 96    | ✓ |  |
| RENAULT | Clio I      | (C57Y)              | 94    | 04/97 | ✓ |  |
| RENAULT | Clio I      | (C57Y/RN,RT)        | 05/97 | 98    | ✓ |  |
| RENAULT | Clio I      | (C571, C571)        | 93    | 96    | ✓ |  |
| RENAULT | Clio I      | (C572, C573)        | 90    | 96    | ✓ |  |
| RENAULT | Clio I      | (C574)              | 91    | 96    | ✓ |  |
| RENAULT | Clio I      | (C577)              | 94    | 96    | ✓ |  |
| RENAULT | Clio I      | (C579)              | 93    | 96    | ✓ |  |
| RENAULT | Clio I      | (S57A, R)           | 92    | 98    | ✓ |  |
| RENAULT | Clio I      | (S571)              | 93    | 96    | ✓ |  |
| RENAULT | Clio I      | (S572)              | 91    | 96    | ✓ |  |
| RENAULT | Clio I      | (S577)              | 94    | 96    | ✓ |  |
| RENAULT | Clio I      | (357E, F, G, J, L)  | 94    | 96    | ✓ |  |
| RENAULT | Clio I      | (357R/RN,RL)        | 05/97 | 98    | ✓ |  |
| RENAULT | Clio I      | (357R, U, V, W)     | 96    | 04/97 | ✓ |  |
| RENAULT | Clio I      | (357Y, K)           | 96    | 98    | ✓ |  |
| RENAULT | Clio II     |                     | 98    | 05    | ✓ |  |
| RENAULT | R 5 Super   | 1.0, 1.1, 1.2       | 87    | 95    | ✓ |  |
| RENAULT | R 5 Super   | 1.4, 1.4 Turbo, 1.7 | 87    | 93    | ✓ |  |
| RENAULT | R 5 Express | 1.0, 1.1            | 85    | 92    | ✓ |  |
| RENAULT | R 5 Express | 1.2, 1.4            | 86    | 98    | ✓ |  |
| RENAULT | R 5 Express | 1.2 Extra           | 92    | 94    | ✓ |  |
| RENAULT | R 9         |                     | 82    | 89    | ✓ |  |
| RENAULT | R 11        |                     | 83    | 89    | ✓ |  |
| RENAULT | R 19        | 1.2, 1.4            | 88    | 95    | ✓ |  |
| RENAULT | Thalia      | 1.4 8V              | 00    | 06    | ✓ |  |
| RENAULT | Twingo      |                     | 93    | 02    | ✓ |  |

**701 307**



|         |                          |                        |       |       |   |  |
|---------|--------------------------|------------------------|-------|-------|---|--|
| RENAULT | Laguna I                 | Front                  | 93    | 98    | ✓ |  |
| RENAULT | Megane I Hatchback       | 2.0 16V (BA0H)         | 95    | 09/98 | ✓ |  |
| RENAULT | Megane I Cabriolet       | 2.0 16V (EA0H)         | 95    | 09/98 | ✓ |  |
| RENAULT | Megane I Coupé           | 2.0 16V (DA0H)         | 95    | 09/98 | ✓ |  |
| RENAULT | Megane Scenic I          | 1.6 (JA04)             | 01/98 | 06/98 | ✓ |  |
| RENAULT | Megane Scenic I          | 1.9 D, 1.9 dT, 1.9 dTi | 97    | 06/98 | ✓ |  |
| RENAULT | Megane Scenic I          | 2.0 (JA_)              | 97    | 06/98 | ✓ |  |
| RENAULT | Safrane 2.0              | (B54E, B542)           | 92    | 07/96 | ✓ |  |
| RENAULT | Safrane 2.0 16V          | (B54L)                 | 07/96 | 00    | ✓ |  |
| RENAULT | Safrane 2.1 Turbo Diesel | (B546)                 | 93    | 07/96 | ✓ |  |
| RENAULT | Safrane 2.2              | (B541)                 | 92    | 07/96 | ✓ |  |
| RENAULT | Safrane 2.2              | (B54H, B543)           | 92    | 96    | ✓ |  |
| RENAULT | Safrane 2.2 Turbo Diesel | (B54G)                 | 96    | 00    | ✓ |  |
| RENAULT | Safrane 2.5 20V          | (B54F)                 | 96    | 00    | ✓ |  |
| RENAULT | Safrane 2.5 Turbo Diesel | (B548)                 | 92    | 00    | ✓ |  |
| RENAULT | Safrane 2.9 24V          | (B54N)                 | 99    | 00    | ✓ |  |
| RENAULT | Safrane 3.0 V6           | (B54B, B544)           | 92    | 00    | ✓ |  |
| RENAULT | Safrane 3.0 V6 4x4       | (B54B, B544)           | 92    | 07/96 | ✓ |  |
| RENAULT | Safrane 3.0 Biturbo 4x4  | (B545)                 | 93    | 07/96 | ✓ |  |

**701 319**



|         |             |                            |    |    |   |  |
|---------|-------------|----------------------------|----|----|---|--|
| RENAULT | R 5 Super   | 1.4 GT Turbo, 1.7 GT Turbo | 87 | 93 | ✓ |  |
| RENAULT | R 5 Super   | 1.6 Diesel                 | 87 | 96 | ✓ |  |
| RENAULT | R 5 Express | 1.6 Diesel                 | 86 | 98 | ✓ |  |
| RENAULT | R 5 Express | 1.9 Diesel                 | 91 | 98 | ✓ |  |
| RENAULT | R 9 Diesel  |                            | 82 | 89 | ✓ |  |
| RENAULT | R 9 Turbo   |                            | 85 | 89 | ✓ |  |
| RENAULT | R 11 Diesel |                            | 83 | 89 | ✓ |  |
| RENAULT | R 11 Turbo  |                            | 84 | 89 | ✓ |  |



**701 326**

|         |                                       |    |       |   |   |
|---------|---------------------------------------|----|-------|---|---|
| RENAULT | Espace I 2.0, 2.0 4x4 (J112, S112)    | 85 | 90    | ✓ |   |
| RENAULT | Espace I 2.1 Diesel (J115, S115)      | 85 | 90    | ✓ |   |
| RENAULT | Espace I 2.2, 2.2 4x4 (J116, J117)    | 87 | 90    | ✓ |   |
| RENAULT | Espace II 2.0 (J636)                  | 91 | 10/96 | ✓ |   |
| RENAULT | Espace II 2.1 Diesel (J63D/E, S63D)   | 91 | 10/96 | ✓ |   |
| RENAULT | Espace II 2.1 Diesel (J633/4/5, S635) | 91 | 10/96 | ✓ |   |
| RENAULT | Espace II 2.1 Diesel 4x4 (J635)       | 91 | 94    | ✓ |   |
| RENAULT | Espace II 2.2 (J63G, J637, S637)      | 91 | 10/96 | ✓ |   |
| RENAULT | Espace II 2.2 4x4 (J637)              | 91 | 10/96 | ✓ |   |
| RENAULT | Espace II 2.8 V6 (J63J, J638)         | 91 | 10/96 | ✓ |   |
| RENAULT | Fuego 1.4 TL/GTL, 1.6 TS/GTS          | 80 | 85    | ✓ |   |
| RENAULT | Fuego 1.6 Turbo, 1.8 TX/GTX           | 80 | 85    | ✓ |   |
| RENAULT | Fuego Turbo Diesel                    | 80 | 85    | ✓ |   |
| RENAULT | R 18 1.4 GTL, L, TL, GTS, TS (R1340)  | 84 | 86    | ✓ |   |
| RENAULT | R 18 1.4 GTL, L, TL (R1350)           | 83 | 84    | ✓ |   |
| RENAULT | R 18 1.4 4x2 TS, GTL (R1351)          | 83 | 86    | ✓ |   |
| RENAULT | R 18 1.4 4x2 GTS, GTX (R1353)         | 83 | 86    | ✓ |   |
| RENAULT | R 18 1.4 (R2350)                      | 83 | 86    | ✓ |   |
| RENAULT | R 18 1.6 (R134A)                      | 84 | 85    | ✓ |   |
| RENAULT | R 18 1.6 Turbo (R1345)                | 81 | 85    | ✓ |   |
| RENAULT | R 18 1.6 Turbo (R1355)                | 83 | 85    | ✓ |   |
| RENAULT | R 18 1.7 GTS (R1342)                  | 82 | 86    | ✓ |   |
| RENAULT | R 18 1.7 GTS, GTX (R1352)             | 82 | 86    | ✓ |   |
| RENAULT | R 18 2.0 GTX, TX (R1343)              | 82 | 86    | ✓ |   |
| RENAULT | R 18 2.0 4x4 TX (R1353)               | 83 | 86    | ✓ |   |
| RENAULT | R 18 2.1 Diesel, Turbo Diesel (R1344) | 81 | 86    | ✓ |   |
| RENAULT | R 18 2.1 Diesel (R1346)               | 84 | 86    | ✓ |   |
| RENAULT | R 18 2.1 4x2 Diesel (R1354)           | 81 | 86    | ✓ |   |
| RENAULT | R 18 2.1 4x2 Turbo Diesel (R1354)     | 81 | 86    | ✓ |   |
| RENAULT | R 18 2.1 4x4 Diesel (R1354)           | 83 | 86    | ✓ |   |
| RENAULT | R 18 2.1 4x4 Turbo Diesel (R1354)     | 83 | 86    | ✓ |   |
| RENAULT | R 18 2.1 Diesel (R1356)               | 84 | 85    | ✓ |   |
| RENAULT | R 18 2.1 Diesel (R2354)               | 79 | 86    | ✓ |   |
| RENAULT | R 20 (R1270)                          | 83 | 84    | ✓ |   |
| RENAULT | R 20 TS, TX (R1272)                   | 81 | 84    | ✓ |   |
| RENAULT | R 20 LS, TS (R1276)                   | 79 | 84    | ✓ |   |
| RENAULT | R 20 Turbo Diesel (R1277)             | 81 | 84    | ✓ |   |
| RENAULT | R 21 2.0 (B48C/R/Y, B483)             | 88 | 94    | ✓ |   |
| RENAULT | R 21 2.0 (K48C/R/Y, K483)             | 88 | 94    | ✓ |   |
| RENAULT | R 21 2.0 (L48C/Q/R/Y)                 | 88 | 94    | ✓ |   |
| RENAULT | R 21 2.0 (L483, L489)                 | 88 | 94    | ✓ |   |
| RENAULT | R 21 2.0 4x4, 2.1 Diesel              | 88 | 94    | ✓ |   |
| RENAULT | R 21 2.1 Diesel 4x4                   | 88 | 92    | ✓ |   |
| RENAULT | R 21 2.1 Turbo Diesel, 2.2, 2.2 4x4   | 88 | 94    | ✓ |   |
| RENAULT | R 25 2.0                              | 89 | 93    | ✓ |   |
| RENAULT | R 25 2.1 Diesel, 2.1 Turbo Diesel     | 84 | 92    | ✓ |   |
| RENAULT | R 25 2.2, 2.4 V6 Turbo                | 84 | 90    | ✓ |   |
| RENAULT | R 25 2.5 V6 Turbo, 2.7 V6, 2.8 V6     | 84 | 92    | ✓ |   |
| RENAULT | R 30 2.1 Turbo Diesel                 | 82 | 84    | ✓ |   |
| RENAULT | Sport Spider                          | 95 | 99    | ✓ | ✓ |

**701 332**

|         |                               |       |    |   |  |
|---------|-------------------------------|-------|----|---|--|
| DACIA   | Dacia 1.2, 1.3, 1.4           | 78    | 99 | ✓ |  |
| DACIA   | Denem                         | 82    | 99 | ✓ |  |
| DACIA   | Shifter                       | 82    | 99 | ✓ |  |
| RENAULT | R 12 L, TL (R1170)            | 10/77 | 80 | ✓ |  |
| RENAULT | R 12 (R1171, R1330/7/8)       | 10/77 | 80 | ✓ |  |
| RENAULT | R 12 (R2360)                  | 10/77 | 80 | ✓ |  |
| RENAULT | R 17                          | 10/77 | 80 | ✓ |  |
| RENAULT | R 18 1.4 GTL, L, TL (R1340)   | 81    | 83 | ✓ |  |
| RENAULT | R 18 1.4 GTS, TS (R1341)      | 78    | 83 | ✓ |  |
| RENAULT | R 18 1.4 GTL, L, TL (R1350)   | 79    | 82 | ✓ |  |
| RENAULT | R 18 1.4 4x2 TS (R1351)       | 79    | 82 | ✓ |  |
| RENAULT | R 18 1.4 4x2 GTS, GTX (R1353) | 82    | 82 | ✓ |  |
| RENAULT | R 18 1.4 (R2350)              | 79    | 82 | ✓ |  |
| RENAULT | R 20 GTL, L, TL (R1271)       | 77    | 84 | ✓ |  |

**701 346**

|         |                                       |    |       |   |  |
|---------|---------------------------------------|----|-------|---|--|
| RENAULT | Clio I (B57C, L, P, C57L, S57L)       | 91 | 98    | ✓ |  |
| RENAULT | Clio I (B57N)                         | 92 | 98    | ✓ |  |
| RENAULT | Clio I (B57U, C57U)                   | 92 | 96    | ✓ |  |
| RENAULT | Clio I (B574, C574, S576)             | 91 | 96    | ✓ |  |
| RENAULT | Clio I (B576)                         | 90 | 96    | ✓ |  |
| RENAULT | Clio I (C57C)                         | 92 | 04/97 | ✓ |  |
| RENAULT | Clio I (C576)                         | 90 | 96    | ✓ |  |
| RENAULT | R 19 1.2                              | 88 | 95    | ✓ |  |
| RENAULT | R 19 1.4                              | 88 | 95    | ✓ |  |
| RENAULT | R 21 1.4                              | 88 | 93    | ✓ |  |
| RENAULT | R 21 1.6                              | 88 | 91    | ✓ |  |
| RENAULT | R 21 1.6 (K48..)                      | 88 | 92    | ✓ |  |
| RENAULT | R 21 1.7 (B48.., L48.., K48.., S48..) | 88 | 94    | ✓ |  |

**701 374**

|         |     |    |    |   |  |
|---------|-----|----|----|---|--|
| RENAULT | R 4 | 78 | 91 | ✓ |  |
| RENAULT | R 5 | 78 | 85 | ✓ |  |

**701 404**

|         |   |       |       |   |  |
|---------|---|-------|-------|---|--|
| OPEL    | Arena 1.9 D TF19D-F8Q-606                 | 97    | 03    | ✓ |  |
| OPEL    | Arena 1.9 D TF19D-F8Q-600                 | 97    | 03    | ✓ |  |
| OPEL    | Arena 2.5 D TH25D-S8U-782                 | 97    | 03    | ✓ |  |
| OPEL    | Arena 2.5 D TH25D-S8U-780                 | 97    | 03    | ✓ |  |
| RENAULT | R 20 TS, TX (R1272)                       | 78    | 84    | ✓ |  |
| RENAULT | R 20 TS, TX (R1279)                       | 81    | 84    | ✓ |  |
| RENAULT | R 30 2.6, 2.6 TS, 2.6 TX                  | 78    | 84    | ✓ |  |
| RENAULT | Trafic (T)                                | 81    | 04/89 | ✓ |  |
| RENAULT | Trafic 1.7, 2.0, 2.1, 2.2, 2.5 Diesel (T) | 05/89 | 03/01 | ✓ |  |
| RENAULT | Trafic 4x4 (V)                            | 85    | 03/01 | ✓ |  |

**701 424**

|         |                           |    |       |   |  |
|---------|---------------------------|----|-------|---|--|
| OPEL    | Arena 1.9 D TF19D-F8Q-600 | 97 | 03    | ✓ |  |
| OPEL    | Arena 2.5 D TF25D-S8U-780 | 97 | 03    | ✓ |  |
| RENAULT | Trafic (PA, P5, P6, P8)   | 81 | 89    | ✓ |  |
| RENAULT | Trafic (PC)               | 84 | 06/97 | ✓ |  |
| RENAULT | Trafic (P3)               | 81 | 93    | ✓ |  |

**701 432**

|         |      |    |    |   |  |
|---------|------|----|----|---|--|
| RENAULT | R 14 | 78 | 83 | ✓ |  |
|---------|------|----|----|---|--|

**701 726**

|         |                          |    |       |   |  |
|---------|--------------------------|----|-------|---|--|
| RENAULT | Master I Series R, T FWD | 81 | 07/98 | ✓ |  |
|---------|--------------------------|----|-------|---|--|

**701 728**

|         |                          |    |       |   |  |
|---------|--------------------------|----|-------|---|--|
| RENAULT | Master I Series P, Q RWD | 81 | 07/98 | ✓ |  |
|---------|--------------------------|----|-------|---|--|

**701 837**

|       |                |       |    |   |  |
|-------|----------------|-------|----|---|--|
| DACIA | Logan 1.4, 1.6 | 04    | 06 | ✓ |  |
| DACIA | Logan 1.5 dCi  | 09/05 | 06 | ✓ |  |

**701 852**

|         |                   |       |       |   |  |
|---------|-------------------|-------|-------|---|--|
| RENAULT | Avantime          | 01    | 05    | ✓ |  |
| RENAULT | Espace III (JE..) | 11/96 | 11/02 | ✓ |  |

**701 860**

|          |                                      |       |    |   |  |
|----------|--------------------------------------|-------|----|---|--|
| NISSAN   | Interstar                            | 02    | 04 | ✓ |  |
| OPEL     | Movano                               | 98    | 04 | ✓ |  |
| RENAULT  | Master II (ED../FD../HD../JD../UD..) | 07/98 | 05 | ✓ |  |
| VAUXHALL | Movano                               | 98    | 05 | ✓ |  |

**701 914**



|         |                |    |       |   |  |
|---------|----------------|----|-------|---|--|
| RENAULT | Laguna I Front | 97 | 03/01 | ✓ |  |
|---------|----------------|----|-------|---|--|

**701 975**

|         |                         |       |    |   |   |
|---------|-------------------------|-------|----|---|---|
| RENAULT | Clio II RS 3.0 V6 Sport | 00    | 05 | ✓ |   |
| RENAULT | Clio II RS 3.0 V6 Sport | 00    | 05 |   | ✓ |
| RENAULT | Laguna II               | 03/01 | 06 | ✓ |   |

**701 977**

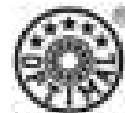
|        |   |       |    |   |  |
|--------|---|-------|----|---|--|
| NISSAN | March 1.2i 16V, 1.4i 16V, 1.5 dCi (K12) | 01/03 | 05 | ✓ |  |
| NISSAN | Micra 1.2i 16V, 1.4i 16V, 1.5 dCi (K12) | 01/03 | 05 | ✓ |  |



**701 977**



|         |                              |                |       |       |   |  |
|---------|------------------------------|----------------|-------|-------|---|--|
| NISSAN  | Note 1.4, 1.5 dCi, 1.6       | (E11)          | 03/06 | 12/06 | ✓ |  |
| RENAULT | Clio III                     | (BR0/1, CR0/1) | 06/05 | 06    | ✓ |  |
| RENAULT | Megane II HB 1.4i 16V        | (BM_, CM_)     | 03    | 06    | ✓ |  |
| RENAULT | Megane II HB 1.5 dCi         | (BM_, CM_)     | 03    | 06    | ✓ |  |
| RENAULT | Megane II HB 1.6i 16V        | (BM_, CM_)     | 03    | 06    | ✓ |  |
| RENAULT | Megane II HB 2.0i 16V        | (BM_, CM_)     | 03    | 06    | ✓ |  |
| RENAULT | Megane II Sedan 1.4i 16V     | (LM0/1)        | 03    | 06    | ✓ |  |
| RENAULT | Megane II Sedan 1.5 dCi      | (LM0/1)        | 03    | 06    | ✓ |  |
| RENAULT | Megane II Sedan 1.6i 16V     | (LM0/1)        | 03    | 06    | ✓ |  |
| RENAULT | Megane II Sedan 2.0i 16V     | (LM0/1)        | 03    | 06    | ✓ |  |
| RENAULT | Megane II Cabriolet 1.4i 16V | (EM0/1)        | 03    | 06    | ✓ |  |
| RENAULT | Megane II Cabriolet 1.5 dCi  | (EM0/1)        | 03    | 06    | ✓ |  |
| RENAULT | Megane II Cabriolet 1.6i 16V | (EM0/1)        | 03    | 06    | ✓ |  |
| RENAULT | Megane II Cabriolet 2.0i 16V | (EM0/1)        | 03    | 06    | ✓ |  |
| RENAULT | Megane II Break 1.4i 16V     | (KM_)          | 03    | 06    | ✓ |  |
| RENAULT | Megane II Break 1.5 dCi      | (KM_)          | 03    | 06    | ✓ |  |
| RENAULT | Megane II Break 1.6i 16V     | (KM_)          | 03    | 06    | ✓ |  |
| RENAULT | Megane II Break 2.0i 16V     | (KM_)          | 03    | 06    | ✓ |  |
| RENAULT | Modus                        | (F/JPO_)       | 12/04 | 06    | ✓ |  |
| RENAULT | Scenic II 1.4i 16V, 1.5 dCi  | (JM0/1)        | 02    | 06    | ✓ |  |
| RENAULT | Scenic II 1.6i 16V, 2.0i 16V | (JM0/1)        | 02    | 06    | ✓ |  |

**701 978**



|         |                             |            |    |    |   |  |
|---------|-----------------------------|------------|----|----|---|--|
| RENAULT | Megane II HB 1.9 dCi        | (BM_, CM_) | 03 | 06 | ✓ |  |
| RENAULT | Megane II Sedan 1.9 dCi     | (LM0/1)    | 03 | 06 | ✓ |  |
| RENAULT | Megane II Cabriolet 1.9 dCi | (EM0/1)    | 03 | 06 | ✓ |  |
| RENAULT | Megane II Break 1.9 dCi     | (KM_)      | 03 | 06 | ✓ |  |
| RENAULT | Scenic II 1.9 dCi           | (JM0/1)    | 02 | 06 | ✓ |  |
| RENAULT | Scenic II - Grand Scenic    |            | 04 | 06 | ✓ |  |

**702 309**



|         |                               |              |       |       |   |  |
|---------|-------------------------------|--------------|-------|-------|---|--|
| RENAULT | Clio I                        | (557W, 657W) | 95    | 98    | ✓ |  |
| RENAULT | Megane Scenic I 1.4           | (JA0E)       | 97    | 09/99 | ✓ |  |
| RENAULT | Megane Scenic I 1.6           | (JA04)       | 01/98 | 04    | ✓ |  |
| RENAULT | Megane Scenic I 1.6           | (JA0F)       | 97    | 09/99 | ✓ |  |
| RENAULT | Megane Scenic I 1.6           | (JA0L)       | 97    | 98    | ✓ |  |
| RENAULT | Megane Scenic I 1.9 D, 1.9 dT | (JA_)        | 97    | 09/99 | ✓ |  |
| RENAULT | Megane Scenic I 1.9 dTi, 2.0  | (JA_)        | 97    | 09/99 | ✓ |  |

**702 311**



|         |                          |              |    |       |   |  |
|---------|--------------------------|--------------|----|-------|---|--|
| RENAULT | Safrane 2.0              | (B54E, B542) | 92 | 02/95 | ✓ |  |
| RENAULT | Safrane 2.0              | (B540)       | 92 | 07/96 | ✓ |  |
| RENAULT | Safrane 2.1 Turbo Diesel | (B546)       | 93 | 07/96 | ✓ |  |
| RENAULT | Safrane 2.2              | (B541)       | 92 | 07/96 | ✓ |  |
| RENAULT | Safrane 2.2              | (B54H, B543) | 92 | 02/95 | ✓ |  |
| RENAULT | Safrane 2.5 Turbo Diesel | (B548)       | 92 | 02/95 | ✓ |  |

**702 312**



|         |                          |                    |       |       |   |  |
|---------|--------------------------|--------------------|-------|-------|---|--|
| DACIA   | Logan 1.4, 1.6           |                    | 04    | 06    | ✓ |  |
| DACIA   | Logan 1.5 dCi            |                    | 09/05 | 06    | ✓ |  |
| NISSAN  | March 1.2i 16V, 1.4i 16V | (K12)              | 01/03 | 05    | ✓ |  |
| NISSAN  | March 1.5 dCi, 1.2i 16V  | (K12)              | 01/03 | 05    | ✓ |  |
| NISSAN  | Micra 1.4i 16V, 1.5 dCi  | (K12)              | 01/03 | 05    | ✓ |  |
| NISSAN  | Note 1.4, 1.5 dCi, 1.6   | (E11)              | 03/06 | 12/06 | ✓ |  |
| RENAULT | Clio I                   | (B57A)             | 91    | 98    | ✓ |  |
| RENAULT | Clio I                   | (B57B)             | 90    | 98    | ✓ |  |
| RENAULT | Clio I                   | (B57B/RL,RN,RT)    | 05/97 | 98    | ✓ |  |
| RENAULT | Clio I                   | (B57B/S)           | 05/97 | 98    | ✓ |  |
| RENAULT | Clio I                   | (B57C, L, P, R, T) | 91    | 98    | ✓ |  |
| RENAULT | Clio I                   | (B57I)             | 93    | 98    | ✓ |  |
| RENAULT | Clio I                   | (B57J)             | 96    | 98    | ✓ |  |
| RENAULT | Clio I                   | (B57J/RN,RT,RL)    | 05/97 | 98    | ✓ |  |
| RENAULT | Clio I                   | (B57J/INITIALE,S)  | 05/97 | 98    | ✓ |  |
| RENAULT | Clio I                   | (B57N, U)          | 92    | 98    | ✓ |  |
| RENAULT | Clio I                   | (B57S)             | 94    | 96    | ✓ |  |
| RENAULT | Clio I                   | (B57Y)             | 94    | 98    | ✓ |  |
| RENAULT | Clio I                   | (B571, B572, B573) | 90    | 96    | ✓ |  |
| RENAULT | Clio I                   | (B574)             | 91    | 96    | ✓ |  |

**702 312**



|         |                                   |                      |       |       |   |  |
|---------|-----------------------------------|----------------------|-------|-------|---|--|
| RENAULT | Clio I                            | (B576)               | 90    | 96    | ✓ |  |
| RENAULT | Clio I                            | (B577)               | 94    | 96    | ✓ |  |
| RENAULT | Clio I                            | (557B, F, G, J, L)   | 94    | 98    | ✓ |  |
| RENAULT | Clio I                            | (557K, N, R, U, Y)   | 96    | 98    | ✓ |  |
| RENAULT | Clio I                            | (C57A)               | 91    | 98    | ✓ |  |
| RENAULT | Clio I                            | (C57B)               | 90    | 98    | ✓ |  |
| RENAULT | Clio I                            | (C57B/RN,RT)         | 05/97 | 98    | ✓ |  |
| RENAULT | Clio I                            | (C57B/RTI,S)         | 05/97 | 98    | ✓ |  |
| RENAULT | Clio I                            | (C57C)               | 92    | 98    | ✓ |  |
| RENAULT | Clio I                            | (C57I)               | 93    | 98    | ✓ |  |
| RENAULT | Clio I                            | (C57J)               | 96    | 98    | ✓ |  |
| RENAULT | Clio I                            | (C57J/RL,RT)         | 05/97 | 98    | ✓ |  |
| RENAULT | Clio I                            | (C57J/RTI,S)         | 05/97 | 98    | ✓ |  |
| RENAULT | Clio I                            | (C57L)               | 91    | 98    | ✓ |  |
| RENAULT | Clio I                            | (C57R, T)            | 91    | 96    | ✓ |  |
| RENAULT | Clio I                            | (C57S)               | 94    | 96    | ✓ |  |
| RENAULT | Clio I                            | (C57U)               | 92    | 96    | ✓ |  |
| RENAULT | Clio I                            | (C57Y)               | 94    | 04/97 | ✓ |  |
| RENAULT | Clio I                            | (C57Y/RN,RT)         | 05/97 | 98    | ✓ |  |
| RENAULT | Clio I                            | (C57Y/RTI)           | 05/97 | 98    | ✓ |  |
| RENAULT | Clio I                            | (C571)               | 93    | 96    | ✓ |  |
| RENAULT | Clio I                            | (C572, C573)         | 90    | 96    | ✓ |  |
| RENAULT | Clio I                            | (C574)               | 91    | 96    | ✓ |  |
| RENAULT | Clio I                            | (C576)               | 90    | 96    | ✓ |  |
| RENAULT | Clio I                            | (C577)               | 94    | 96    | ✓ |  |
| RENAULT | Clio I                            | (S57A)               | 92    | 98    | ✓ |  |
| RENAULT | Clio I                            | (S57I)               | 93    | 98    | ✓ |  |
| RENAULT | Clio I                            | (S57L)               | 91    | 98    | ✓ |  |
| RENAULT | Clio I                            | (S57R)               | 92    | 98    | ✓ |  |
| RENAULT | Clio I                            | (S571)               | 93    | 96    | ✓ |  |
| RENAULT | Clio I                            | (S572, S576)         | 91    | 96    | ✓ |  |
| RENAULT | Clio I                            | (S577, 357F,G, J, L) | 94    | 96    | ✓ |  |
| RENAULT | Clio I                            | (357K, N, U, Y)      | 96    | 98    | ✓ |  |
| RENAULT | Clio I                            | (357R)               | 96    | 04/97 | ✓ |  |
| RENAULT | Clio I                            | (357R/RN,RL)         | 05/97 | 98    | ✓ |  |
| RENAULT | Clio I                            | (657H, K, M, N)      | 96    | 98    | ✓ |  |
| RENAULT | Clio II                           |                      | 98    | 05    | ✓ |  |
| RENAULT | Clio III                          | (BR0/1, CR0/1)       | 06/05 | 06    | ✓ |  |
| RENAULT | Megane I Hatchback 1.4, 1.6, 1.8  | (BA_)                | 95    | 04    | ✓ |  |
| RENAULT | Megane I Hatchback 1.9 D, 1.9 dTi | (BA_)                | 95    | 04    | ✓ |  |
| RENAULT | Megane I Hatchback 1.9 dTi,       | (BA_)                | 95    | 04    | ✓ |  |
| RENAULT | Megane I Hatchback 1.9 dCi, 2.0i  | (BA_)                | 95    | 04    | ✓ |  |
| RENAULT | Megane I Hatchback 2.0 16V        | (BA0H)               | 95    | 04    | ✓ |  |
| RENAULT | Megane I Cabriolet 1.4, 1.6, 2.0  | (EA_)                | 95    | 02    | ✓ |  |
| RENAULT | Megane I Cabriolet 2.0 16V        | (EA0H)               | 95    | 02    | ✓ |  |
| RENAULT | Megane I Classic                  | (LA_)                | 95    | 04    | ✓ |  |
| RENAULT | Megane I Coupé 1.4, 1.6, 2.0i     | (DA_)                | 95    | 02    | ✓ |  |
| RENAULT | Megane I Coupé 1.9 dTi, 1.9 dCi   | (DA_)                | 95    | 02    | ✓ |  |
| RENAULT | Megane I Coupé 2.0 16V            | (DA0H)               | 95    | 02    | ✓ |  |
| RENAULT | Modus                             | (F/JPO_)             | 12/04 | 06    | ✓ |  |
| RENAULT | R 5 Super 1.0, 1.1, 1.2           |                      | 87    | 95    | ✓ |  |
| RENAULT | R 5 Super 1.4, 1.4 Turbo, 1.7     |                      | 87    | 93    | ✓ |  |
| RENAULT | R 5 Super 1.6 Diesel              |                      | 87    | 96    | ✓ |  |
| RENAULT | R 9, R 9 Diesel                   |                      | 82    | 89    | ✓ |  |
| RENAULT | R 11, T 11 Diesel                 |                      | 83    | 89    | ✓ |  |
| RENAULT | R 19 1.2, 1.4, 1.7, 1.8           |                      | 88    | 95    | ✓ |  |
| RENAULT | R 19 1.9 Diesel, 1.9 Turbo Diesel |                      | 88    | 95    | ✓ |  |
| RENAULT | Thalia 1.2 16V, 1.6 16V           |                      | 02    | 06    | ✓ |  |
| RENAULT | Thalia 1.4 8V, 1.4 16V            |                      | 00    | 06    | ✓ |  |
| RENAULT | Thalia 1.5 dCi                    |                      | 01    | 06    | ✓ |  |
| RENAULT | Twingo                            |                      | 93    | 02    | ✓ |  |

**702 313**



|         |                          |              |       |       |   |  |
|---------|--------------------------|--------------|-------|-------|---|--|
| RENAULT | Safrane 2.0              | (B54E, B542) | 02/95 | 07/96 | ✓ |  |
| RENAULT | Safrane 2.0 16V          | (B54L)       | 07/96 | 00    | ✓ |  |
| RENAULT | Safrane 2.2              | (B54H, B543) | 03/95 | 96    | ✓ |  |
| RENAULT | Safrane 2.2 Turbo Diesel | (B54G)       | 96    | 00    | ✓ |  |
| RENAULT | Safrane 2.5 20V          | (B54F)       | 96    | 00    | ✓ |  |

**702 313**

|         |                                 |       |    |  |   |
|---------|---------------------------------|-------|----|--|---|
| RENAULT | Safrane 2.5 Turbo Diesel (B548) | 03/95 | 00 |  | ✓ |
| RENAULT | Safrane 2.9 24V (B54N)          | 99    | 00 |  | ✓ |
| RENAULT | Safrane 3.0 V6 (B54B, B544)     | 92    | 00 |  | ✓ |

**702 316**

|         |                                    |    |    |  |   |
|---------|------------------------------------|----|----|--|---|
| RENAULT | R 5 Express 1.0, 1.1               | 85 | 92 |  | ✓ |
| RENAULT | R 5 Express 1.2 Extra              | 92 | 94 |  | ✓ |
| RENAULT | R 5 Express 1.6 Diesel             | 86 | 98 |  | ✓ |
| RENAULT | R 21 1.6                           | 88 | 91 |  | ✓ |
| RENAULT | R 21 1.7 (B48..., L48..)           | 88 | 94 |  | ✓ |
| RENAULT | R 21 1.9 Diesel (B48..)            | 88 | 94 |  | ✓ |
| RENAULT | R 21 2.0 (B48J)                    | 89 | 94 |  | ✓ |
| RENAULT | R 21 2.0 (L48J)                    | 88 | 94 |  | ✓ |
| RENAULT | R 21 2.1 Diesel (B480, B486)       | 88 | 94 |  | ✓ |
| RENAULT | R 21 2.1 Diesel (L480, L486)       | 88 | 94 |  | ✓ |
| RENAULT | R 21 2.1 Diesel (L480, L48V)       | 88 | 94 |  | ✓ |
| RENAULT | R 21 2.1 Turbo Diesel (B480, B486) | 88 | 94 |  | ✓ |
| RENAULT | R 21 2.1 Turbo Diesel (L480, L486) | 88 | 94 |  | ✓ |
| RENAULT | R 21 2.1 Turbo Diesel (L480, L48V) | 88 | 94 |  | ✓ |

**702 321**

|         |                                     |       |       |  |   |
|---------|-------------------------------------|-------|-------|--|---|
| RENAULT | Megane I Grandtour (KA0_)           | 98    | 04    |  | ✓ |
| RENAULT | Megane Scenic I 1.4 (JA0E)          | 97    | 09/99 |  | ✓ |
| RENAULT | Megane Scenic I 1.6 (JA04)          | 01/98 | 04    |  | ✓ |
| RENAULT | Megane Scenic I 1.6 (JA0F)          | 97    | 99    |  | ✓ |
| RENAULT | Megane Scenic I 1.9 D, 1.9 dT (JA_) | 97    | 09/99 |  | ✓ |
| RENAULT | Megane Scenic I 1.9 dTi, 2.0 (JA_)  | 97    | 09/99 |  | ✓ |

**702 328**

|         |                               |       |    |  |   |
|---------|-------------------------------|-------|----|--|---|
| DACIA   | Dacia 1.2, 1.3, 1.4           | 78    | 99 |  | ✓ |
| DACIA   | Denem                         | 82    | 99 |  | ✓ |
| DACIA   | Shifter                       | 82    | 99 |  | ✓ |
| RENAULT | Fuego 1.4 TL/GTL              | 80    | 85 |  | ✓ |
| RENAULT | R 4                           | 78    | 91 |  | ✓ |
| RENAULT | R 5                           | 78    | 85 |  | ✓ |
| RENAULT | R 12 L, TL (R1170)            | 10/77 | 80 |  | ✓ |
| RENAULT | R 14                          | 78    | 83 |  | ✓ |
| RENAULT | R 16                          | 11/76 | 80 |  | ✓ |
| RENAULT | R 18 1.4 GTL, L, TL (R1340)   | 81    | 86 |  | ✓ |
| RENAULT | R 18 1.4 GTS, TS (R1341)      | 78    | 86 |  | ✓ |
| RENAULT | R 18 1.7 GTS (R1342)          | 82    | 86 |  | ✓ |
| RENAULT | R 18 2.1 Diesel (R1344)       | 81    | 86 |  | ✓ |
| RENAULT | R 18 2.1 Turbo Diesel (R1344) | 81    | 86 |  | ✓ |

**702 350**

|         |                                   |       |       |  |   |
|---------|-----------------------------------|-------|-------|--|---|
| RENAULT | Fuego 1.6 TS/GTS                  | 80    | 06/84 |  | ✓ |
| RENAULT | Fuego 1.8 TX/GTX                  | 80    | 06/84 |  | ✓ |
| RENAULT | Fuego Turbo Diesel                | 80    | 84    |  | ✓ |
| RENAULT | R 17                              | 10/77 | 80    |  | ✓ |
| RENAULT | R 18 1.4 GTL, L, TL (R1350)       | 79    | 84    |  | ✓ |
| RENAULT | R 18 1.4 4x2 TS (R1351)           | 79    | 84    |  | ✓ |
| RENAULT | R 18 1.4 4x2 GTS, GTX (R1353)     | 82    | 84    |  | ✓ |
| RENAULT | R 18 1.4 (R2350)                  | 79    | 84    |  | ✓ |
| RENAULT | R 18 1.6 Turbo (R1345)            | 81    | 83    |  | ✓ |
| RENAULT | R 18 1.7 GTS, GTX (R1352)         | 82    | 86    |  | ✓ |
| RENAULT | R 18 2.0 GTX, TX (R1343)          | 82    | 85    |  | ✓ |
| RENAULT | R 18 2.1 4x2 Diesel (R1354)       | 81    | 83    |  | ✓ |
| RENAULT | R 18 2.1 4x2 Turbo Diesel (R1354) | 81    | 83    |  | ✓ |
| RENAULT | R 18 2.1 Diesel (R2354)           | 79    | 84    |  | ✓ |
| RENAULT | R 20 (R1270)                      | 83    | 83    |  | ✓ |
| RENAULT | R 20 GTL, L, TL (R1271)           | 77    | 84    |  | ✓ |
| RENAULT | R 20 TS, TX (R1272)               | 78    | 84    |  | ✓ |
| RENAULT | R 20 LS, TS (R1276)               | 79    | 83    |  | ✓ |
| RENAULT | R 20 Turbo Diesel (R1277)         | 81    | 83    |  | ✓ |
| RENAULT | R 20 TS, TX (R1279)               | 81    | 84    |  | ✓ |
| RENAULT | R 30 2.1 Turbo Diesel             | 82    | 83    |  | ✓ |
| RENAULT | R 30 2.6, 2.6 TS, 2.6 TX          | 78    | 84    |  | ✓ |

**702 351**

|         |                    |      |    |       |  |   |
|---------|--------------------|------|----|-------|--|---|
| RENAULT | Laguna I Grandtour | Rear | 93 | 03/01 |  | ✓ |
|---------|--------------------|------|----|-------|--|---|

**702 352**

|         |  |       |       |  |   |
|---------|--|-------|-------|--|---|
| RENAULT | Clio I (B57A, L)                       | 94    | 98    |  | ✓ |
| RENAULT | Clio I (B57B, I)                       | 93    | 98    |  | ✓ |
| RENAULT | Clio I (B57B/RL,RN,RT)                 | 05/97 | 98    |  | ✓ |
| RENAULT | Clio I (B57B/S)                        | 05/97 | 98    |  | ✓ |
| RENAULT | Clio I (B57C)                          | 91    | 98    |  | ✓ |
| RENAULT | Clio I (B57J)                          | 96    | 98    |  | ✓ |
| RENAULT | Clio I (B57J/RN,RT,RL)                 | 05/97 | 98    |  | ✓ |
| RENAULT | Clio I (B57J/INITIALE,S)               | 05/97 | 98    |  | ✓ |
| RENAULT | Clio I (B57S)                          | 94    | 96    |  | ✓ |
| RENAULT | Clio I (B57T)                          | 93    | 96    |  | ✓ |
| RENAULT | Clio I (B57U)                          | 92    | 96    |  | ✓ |
| RENAULT | Clio I (B57Y)                          | 94    | 98    |  | ✓ |
| RENAULT | Clio I (B574)                          | 91    | 96    |  | ✓ |
| RENAULT | Clio I (B578)                          | 94    | 98    |  | ✓ |
| RENAULT | Clio I (557A)                          | 94    | 98    |  | ✓ |
| RENAULT | Clio I (557D, G, J)                    | 94    | 96    |  | ✓ |
| RENAULT | Clio I (557K, N, R, U, Y)              | 96    | 98    |  | ✓ |
| RENAULT | Clio I (C57A)                          | 94    | 98    |  | ✓ |
| RENAULT | Clio I (C57B, I)                       | 93    | 98    |  | ✓ |
| RENAULT | Clio I (C57B/RN,RT)                    | 05/97 | 98    |  | ✓ |
| RENAULT | Clio I (C57B/RTI,S)                    | 05/97 | 98    |  | ✓ |
| RENAULT | Clio I (C57C)                          | 92    | 98    |  | ✓ |
| RENAULT | Clio I (C57D)                          | 91    | 96    |  | ✓ |
| RENAULT | Clio I (C57H)                          | 94    | 98    |  | ✓ |
| RENAULT | Clio I (C57J)                          | 96    | 98    |  | ✓ |
| RENAULT | Clio I (C57J/RL,RT)                    | 05/97 | 98    |  | ✓ |
| RENAULT | Clio I (C57J/RTI,S)                    | 05/97 | 98    |  | ✓ |
| RENAULT | Clio I (C57L)                          | 91    | 98    |  | ✓ |
| RENAULT | Clio I (C57M, S)                       | 94    | 96    |  | ✓ |
| RENAULT | Clio I (C57T)                          | 93    | 96    |  | ✓ |
| RENAULT | Clio I (C57U)                          | 92    | 96    |  | ✓ |
| RENAULT | Clio I (C57Y)                          | 94    | 04/97 |  | ✓ |
| RENAULT | Clio I (C57Y/RN,RT)                    | 05/97 | 98    |  | ✓ |
| RENAULT | Clio I (C57Y/RTI)                      | 05/97 | 98    |  | ✓ |
| RENAULT | Clio I (C574)                          | 94    | 96    |  | ✓ |
| RENAULT | Clio I (C575)                          | 90    | 96    |  | ✓ |
| RENAULT | Clio I (C578)                          | 94    | 98    |  | ✓ |
| RENAULT | Clio I (C579)                          | 93    | 96    |  | ✓ |
| RENAULT | Clio I (357A, K, N)                    | 94    | 98    |  | ✓ |
| RENAULT | Clio I (357D, E, G, J)                 | 94    | 96    |  | ✓ |
| RENAULT | Clio I (357R)                          | 96    | 04/97 |  | ✓ |
| RENAULT | Clio I (357R/RN,RL)                    | 05/97 | 98    |  | ✓ |
| RENAULT | Clio I (357U, V, Y)                    | 96    | 98    |  | ✓ |
| RENAULT | Clio II                                | 98    | 05    |  | ✓ |
| RENAULT | Megane I Hatchback 1.4, 1.6, 1.8 (BA_) | 95    | 04    |  | ✓ |
| RENAULT | Megane I Hatchback 1.9 D, 1.9 dT(BA_)  | 95    | 04    |  | ✓ |
| RENAULT | Megane I Hatchback 1.9 dTi (BA_)       | 95    | 04    |  | ✓ |
| RENAULT | Megane I Hatchback 1.9 dCi, 2.0i (BA_) | 95    | 04    |  | ✓ |
| RENAULT | Megane I Hatchback 2.0 16V (BA0H)      | 95    | 04    |  | ✓ |
| RENAULT | Megane I Cabriolet 1.4, 1.6, 2.0 (EA_) | 95    | 02    |  | ✓ |
| RENAULT | Megane I Cabriolet 2.0 16V (EA0H)      | 95    | 02    |  | ✓ |
| RENAULT | Megane I Classic (LA_)                 | 95    | 04    |  | ✓ |
| RENAULT | Megane I Coupé 1.4, 1.6, 2.0i (DA_)    | 95    | 02    |  | ✓ |
| RENAULT | Megane I Coupé 1.9 dTi, 1.9 dCi (DA_)  | 95    | 02    |  | ✓ |
| RENAULT | Megane I Coupé 2.0 16V (DA0H)          | 95    | 02    |  | ✓ |
| RENAULT | R 5 Super 1.4 GT Turbo, 1.7 GT Turbo   | 87    | 93    |  | ✓ |
| RENAULT | R 9 Turbo                              | 85    | 89    |  | ✓ |
| RENAULT | R 11 Turbo                             | 84    | 89    |  | ✓ |
| RENAULT | R 19 1.4, 1.7, 1.8, 1.8 16V            | 88    | 95    |  | ✓ |
| RENAULT | R 19 1.9 Diesel, 1.9 Turbo Diesel      | 88    | 95    |  | ✓ |
| RENAULT | Thalia 1.2 16V, 1.6 16V                | 02    | 06    |  | ✓ |
| RENAULT | Thalia 1.4 8V, 1.4 16V                 | 00    | 06    |  | ✓ |
| RENAULT | Thalia 1.5 dCi                         | 01    | 06    |  | ✓ |



**702 552**

|         |                     |    |    |  |   |
|---------|---------------------|----|----|--|---|
| RENAULT | R 25 2.7 V6, 2.8 V6 | 84 | 92 |  | ✓ |
|---------|---------------------|----|----|--|---|

**702 586**

|         |                                 |       |       |  |   |
|---------|---------------------------------|-------|-------|--|---|
| OPEL    | Arena 1.9 D TF19D-F8Q-600       | 97    | 03    |  | ✓ |
| OPEL    | Arena 1.9 D TH19D-F8Q-600       | 97    | 03    |  | ✓ |
| RENAULT | Trafic 1.7, 2.0, 2.1 Diesel (T) | 05/89 | 03/01 |  | ✓ |

**702 603**

|         |  |       |    |  |   |
|---------|--|-------|----|--|---|
| RENAULT | Megane Scenic I 1.4, 1.6, 2.0 (JA_)    | 09/99 | 04 |  | ✓ |
| RENAULT | Megane Scenic I 1.8 16V (JA_)          | 01    | 04 |  | ✓ |
| RENAULT | Megane Scenic I 1.9 dTi, 1.9 dCi (JA_) | 09/99 | 04 |  | ✓ |

**702 692**

|         |            |    |       |  |   |
|---------|------------|----|-------|--|---|
| RENAULT | Trafic (T) | 81 | 83    |  | ✓ |
| RENAULT | Trafic (T) | 86 | 04/89 |  | ✓ |

**702 765**

|         |                                 |    |       |  |   |
|---------|---------------------------------|----|-------|--|---|
| RENAULT | R 21 2.0 4x4, 2.2 4x4           | 88 | 94    |  | ✓ |
| RENAULT | R 21 2.1 Diesel 4x4             | 88 | 92    |  | ✓ |
| RENAULT | Safrane 3.0 V6 4x4 (B54B, B544) | 92 | 07/96 |  | ✓ |
| RENAULT | Safrane 3.0 Biturbo 4x4 (B545)  | 93 | 07/96 |  | ✓ |

**702 817**

|         |                                |       |    |  |   |
|---------|--------------------------------|-------|----|--|---|
| DACIA   | Dacia 1.2, 1.3, 1.4            | 78    | 99 |  | ✓ |
| RENAULT | R 12 (R1171, R1330/7/8, R2360) | 10/77 | 80 |  | ✓ |

**702 846**

|          |                                      |       |    |  |   |
|----------|--------------------------------------|-------|----|--|---|
| NISSAN   | Interstar                            | 02    | 04 |  | ✓ |
| OPEL     | Movano                               | 98    | 04 |  | ✓ |
| RENAULT  | Master II (ED../FD../HD../JD../UD..) | 07/98 | 05 |  | ✓ |
| VAUXHALL | Movano                               | 98    | 05 |  | ✓ |

**702 850**

|         |        |    |       |  |   |
|---------|--------|----|-------|--|---|
| RENAULT | Kangoo | 98 | 02/03 |  | ✓ |
|---------|--------|----|-------|--|---|

**702 866**

|         |                   |       |       |  |   |
|---------|-------------------|-------|-------|--|---|
| RENAULT | Avantime          | 01    | 05    |  | ✓ |
| RENAULT | Espace III (JE..) | 11/96 | 11/02 |  | ✓ |

**702 899**

|         |           |       |    |  |   |
|---------|-----------|-------|----|--|---|
| RENAULT | Espace IV | 11/02 | 06 |  | ✓ |
| RENAULT | Vel Satis | 02    | 06 |  | ✓ |

**702 915**

|         |                    |      |    |       |   |
|---------|--------------------|------|----|-------|---|
| RENAULT | Laguna I Grandtour | Rear | 93 | 02/97 | ✓ |
|---------|--------------------|------|----|-------|---|

**702 957**

|         |                    |      |       |       |   |
|---------|--------------------|------|-------|-------|---|
| RENAULT | Laguna I Hatchback | Rear | 09/99 | 03/01 | ✓ |
|---------|--------------------|------|-------|-------|---|

**702 958**

|         |                    |      |       |       |   |
|---------|--------------------|------|-------|-------|---|
| RENAULT | Laguna I Hatchback | Rear | 02/97 | 09/99 | ✓ |
|---------|--------------------|------|-------|-------|---|

**702 959**

|         |                    |      |       |       |   |
|---------|--------------------|------|-------|-------|---|
| RENAULT | Laguna I Grandtour | Rear | 09/99 | 03/01 | ✓ |
|---------|--------------------|------|-------|-------|---|

**702 960**

|         |                    |      |       |       |   |
|---------|--------------------|------|-------|-------|---|
| RENAULT | Laguna I Grandtour | Rear | 02/97 | 09/99 | ✓ |
|---------|--------------------|------|-------|-------|---|

**702 976**

|         |           |  |       |    |   |
|---------|-----------|--|-------|----|---|
| RENAULT | Laguna II |  | 03/01 | 06 | ✓ |
|---------|-----------|--|-------|----|---|

**702 982**

|         |                                  |       |    |  |   |
|---------|----------------------------------|-------|----|--|---|
| RENAULT | Clio III (BR0/1, CR0/1)          | 06/05 | 06 |  | ✓ |
| RENAULT | Megane II HB 1.4i 16V (BM_, CM_) | 03    | 06 |  | ✓ |
| RENAULT | Megane II HB 1.5 dCi (BM_, CM_)  | 03    | 06 |  | ✓ |
| RENAULT | Megane II HB 1.6i 16V (BM_, CM_) | 03    | 06 |  | ✓ |
| RENAULT | Megane II HB 1.9 dCi (BM_, CM_)  | 03    | 06 |  | ✓ |
| RENAULT | Megane II HB 2.0i 16V (BM_, CM_) | 03    | 06 |  | ✓ |
| RENAULT | Megane II Sedan 1.4i 16V (LM0/1) | 03    | 06 |  | ✓ |
| RENAULT | Megane II Sedan 1.5 dCi (LM0/1)  | 03    | 06 |  | ✓ |
| RENAULT | Megane II Sedan 1.6i 16V (LM0/1) | 03    | 06 |  | ✓ |
| RENAULT | Megane II Sedan 1.9 dCi (LM0/1)  | 03    | 06 |  | ✓ |

**702 982**

|         |                                      |       |    |  |   |
|---------|--------------------------------------|-------|----|--|---|
| RENAULT | Megane II Sedan 2.0i 16V (LM0/1)     | 03    | 06 |  | ✓ |
| RENAULT | Megane II Cabriolet 1.4i 16V (EM0/1) | 03    | 06 |  | ✓ |
| RENAULT | Megane II Cabriolet 1.5 dCi (EM0/1)  | 03    | 06 |  | ✓ |
| RENAULT | Megane II Cabriolet 1.6i 16V (EM0/1) | 03    | 06 |  | ✓ |
| RENAULT | Megane II Cabriolet 1.9 dCi (EM0/1)  | 03    | 06 |  | ✓ |
| RENAULT | Megane II Cabriolet 2.0i 16V (EM0/1) | 03    | 06 |  | ✓ |
| RENAULT | Modus (F/JPO_)                       | 12/04 | 06 |  | ✓ |

**702 983**

|         |                                     |    |    |  |   |
|---------|-------------------------------------|----|----|--|---|
| RENAULT | Megane II Break 1.4i 16V (KM_)      | 03 | 06 |  | ✓ |
| RENAULT | Megane II Break 1.5 dCi (KM_)       | 03 | 06 |  | ✓ |
| RENAULT | Megane II Break 1.6i 16V (KM_)      | 03 | 06 |  | ✓ |
| RENAULT | Megane II Break 1.9 dCi (KM_)       | 03 | 06 |  | ✓ |
| RENAULT | Megane II Break 2.0i 16V (KM_)      | 03 | 06 |  | ✓ |
| RENAULT | Scenic II 1.4i 16V, 1.5 dCi (JM0/1) | 02 | 06 |  | ✓ |
| RENAULT | Scenic II 1.6i 16V, 1.9 dCi (JM0/1) | 02 | 06 |  | ✓ |
| RENAULT | Scenic II 2.0i 16V (JM0/1)          | 02 | 06 |  | ✓ |

**800 304**

|         |  |       |       |  |   |
|---------|--|-------|-------|--|---|
| FIAT    | 128                                      | 80    | 84    |  | ✓ |
| FIAT    | Duna 60 1.1, Duna 70 1.3, Duna DS 1.7    | 87    | 03/88 |  | ✓ |
| FIAT    | Duna Citvan, Penny, Weekend              | 87    | 03/88 |  | ✓ |
| FIAT    | Fiorino 1050                             | 79    | 87    |  | ✓ |
| FIAT    | Fiorino 1.3                              | 79    | 03/88 |  | ✓ |
| FIAT    | Fiorino 1.1, 1.3 Diesel, 1.5, 1.7 Diesel | 87    | 03/88 |  | ✓ |
| FIAT    | Regata 1.3, 1.5, 1.6                     | 83    | 03/88 |  | ✓ |
| FIAT    | Regata 1.7 Diesel, 1.9 Diesel            | 86    | 03/88 |  | ✓ |
| FIAT    | Regata Weekend                           | 85    | 03/88 |  | ✓ |
| FIAT    | Ritmo 60, 65, 70, 75, 85, 105 TC 1.6     | 78    | 87    |  | ✓ |
| FIAT    | Ritmo Diesel 1.7, Turbo Diesel 1.9       | 78    | 87    |  | ✓ |
| FIAT    | Uno CS 1.1, 1.4 Turbo Diesel             | 86    | 03/88 |  | ✓ |
| FIAT    | Uno 1.3 Turbo i.e.                       | 85    | 03/88 |  | ✓ |
| FIAT    | Uno 1.7 Diesel                           | 87    | 03/88 |  | ✓ |
| FIAT    | Uno 1.7 Diesel CS                        | 86    | 03/88 |  | ✓ |
| FIAT    | X 1/9 Five speed 1.5                     | 79    | 89    |  | ✓ |
| LANCIA  | Delta I 1.3, 1.5                         | 80    | 03/88 |  | ✓ |
| LANCIA  | Delta I 1.6, 1.6 i.e., 1.6 Turbo         | 83    | 03/88 |  | ✓ |
| LANCIA  | Delta I 1.9 Turbo Diesel                 | 83    | 03/88 |  | ✓ |
| LANCIA  | Delta Integrale 4x4                      | 86    | 87    |  | ✓ |
| LANCIA  | Delta Integrale 4x4                      | 01/86 | 03/88 |  | ✓ |
| LANCIA  | Prisma 1.3, 1.5, 1.6, 1.6 i.e.           | 83    | 03/88 |  | ✓ |
| LANCIA  | Prisma 1.9 Diesel, 1.9 Turbo Diesel      | 83    | 03/88 |  | ✓ |
| LANCIA  | Prisma Integrale 4x4                     | 86    | 87    |  | ✓ |
| LANCIA  | Prisma Integrale 4x4                     | 86    | 03/88 |  | ✓ |
| SAAB    | 600 1.5                                  | 80    | 87    |  | ✓ |
| ZASTAVA | Yugo 101                                 | 07/82 | 90    |  | ✓ |

**800 366**

|        |  |       |       |  |   |
|--------|--|-------|-------|--|---|
| FIAT   | Duna 60 1.1, Duna 70 1.3, Duna DS 1.7    | 03/88 | 93    |  | ✓ |
| FIAT   | Duna Citvan, Penny, Weekend              | 03/88 | 93    |  | ✓ |
| FIAT   | Fiorino 1.1                              | 03/88 | 06/93 |  | ✓ |
| FIAT   | Fiorino 1.3, 1.3 Diesel, 1.5, 1.7 Diesel | 03/88 | 06/93 |  | ✓ |
| FIAT   | Regata 1.3, 1.5, 1.6, 1.7 Diesel         | 03/88 | 90    |  | ✓ |
| FIAT   | Regata 1.9 Diesel, Regata Weekend        | 03/88 | 90    |  | ✓ |
| FIAT   | Uno CS 1.1, 1.3 Turbo i.e.               | 03/88 | 92    |  | ✓ |
| FIAT   | Uno 1.4 Turbo i.e.                       | 03/88 | 96    |  | ✓ |
| FIAT   | Uno 1.4 Turbo Diesel, 1.7 Diesel         | 03/88 | 95    |  | ✓ |
| FIAT   | Uno 1.7 Diesel CS                        | 03/88 | 95    |  | ✓ |
| FIAT   | Uno 1.9 Diesel                           | 90    | 95    |  | ✓ |
| LANCIA | Delta I 1.3, 1.5                         | 03/88 | 92    |  | ✓ |
| LANCIA | Delta I 1.6, 1.6 i.e., 1.6 Turbo         | 03/88 | 92    |  | ✓ |
| LANCIA | Delta I 1.9 Turbo Diesel                 | 03/88 | 92    |  | ✓ |
| LANCIA | Delta Integrale 4x4                      | 03/88 | 91    |  | ✓ |
| LANCIA | Prisma 1.3, 1.5, 1.6, 1.6 i.e.           | 03/88 | 89    |  | ✓ |
| LANCIA | Prisma 1.9 Diesel, 1.9 Turbo Diesel      | 03/88 | 89    |  | ✓ |
| LANCIA | Prisma Integrale 4x4                     | 03/88 | 89    |  | ✓ |



**800 398**



|            |   |       |       |   |   |
|------------|---|-------|-------|---|---|
| ALFA ROMEO | Alfa 145  | 94    | 98    | ✓ |   |
| ALFA ROMEO | Alfa 145 1.4 i.e., 1.6 i.e., 1.7 i.e., 1.8 i.e. | 99    | 01    | ✓ |   |
| ALFA ROMEO | Alfa 145 2.0 16V                                | 99    | 01    | ✓ |   |
| ALFA ROMEO | Alfa 146  | 94    | 98    | ✓ |   |
| ALFA ROMEO | Alfa 146 1.4 i.e., 1.6 i.e., 1.7 i.e., 1.8 i.e. | 99    | 01    | ✓ |   |
| ALFA ROMEO | Alfa 146 2.0 16V                                | 99    | 01    | ✓ |   |
| ALFA ROMEO | Alfa 155 1.6 TS, 1.6 TS 16V                     | 92    | 98    | ✓ |   |
| ALFA ROMEO | Alfa 155 1.7 TS, 1.7 TS 16V                     | 92    | 97    | ✓ |   |
| ALFA ROMEO | Alfa 155 1.8 TS, 1.8 TS 16V                     | 92    | 97    | ✓ |   |
| ALFA ROMEO | Alfa 155 1.9 Turbo Diesel                       | 92    | 97    | ✓ |   |
| ALFA ROMEO | Alfa 155 2.0 TS, 2.0 TS 16V                     | 92    | 97    | ✓ |   |
| ALFA ROMEO | GTV II 1.8 16V, 2.0 TS 16V                      | 95    | 04/00 | ✓ |   |
| ALFA ROMEO | Spider II 1.8 16V, 2.0 TS 16V                   | 95    | 04/00 | ✓ |   |
| FIAT       | Barchetta 1.8 16V                               | 95    | 04    | ✓ |   |
| FIAT       | Brava 1.6 16V, 1.9 JTD                          | 10/98 | 01    | ✓ |   |
| FIAT       | Brava 1.8 GT 16V, 1.9 Turbo Diesel              | 95    | 01    | ✓ |   |
| FIAT       | Bravo 1.6 16V, 1.9 JTD                          | 10/98 | 01    | ✓ |   |
| FIAT       | Bravo 1.8 GT 16V, 1.9 Turbo Diesel              | 95    | 01    | ✓ |   |
| FIAT       | Coupé 1.8 16V, 2.0 16V, 2.0 20V                 | 94    | 05    | ✓ |   |
| FIAT       | Doblò 1.3 JTD                                   | 05/04 | 05    | ✓ |   |
| FIAT       | Doblò 1.9 JTD                                   | 10/01 | 05    | ✓ |   |
| FIAT       | Marea 1.6 16V, 1.8 16V                          | 96    | 05    | ✓ |   |
| FIAT       | Marea 1.9 Turbo Diesel, 1.9 JTD                 | 96    | 05    | ✓ |   |
| FIAT       | Multipla  | 99    | 05    | ✓ |   |
| FIAT       | Panda II 1.3 JTD                                | 03    | 06    | ✓ |   |
| FIAT       | Punto I 1.4 GT Turbo                            | 93    | 09/99 | ✓ |   |
| FIAT       | Punto I 1.7 TD 51 kW                            | 94    | 09/99 | ✓ |   |
| FIAT       | Punto I 1.7 TD 52 kW                            | 94    | 00    | ✓ |   |
| FIAT       | Punto II 1.3 JTD                                | 03    | 06    | ✓ |   |
| FIAT       | Punto II 1.8 16V HGT                            | 09/99 | 06    | ✓ |   |
| FIAT       | Punto II 1.9 JTD                                | 01    | 06    | ✓ |   |
| FIAT       | Tempra 1.8 i.e., 1.9 Turbo Diesel               | 90    | 96    | ✓ |   |
| FIAT       | Tempra 2.0 i.e.                                 | 90    | 96    | ✓ |   |
| FIAT       | Tempra 2.0 i.e. 4x4                             | 92    | 96    | ✓ | ✓ |
| FIAT       | Tipo 1.6 AGT, DGT                               | 06/89 | 90    | ✓ |   |
| FIAT       | Tipo 1.8 i.e.                                   | 91    | 95    | ✓ |   |
| FIAT       | Tipo 1.8 16V Sport                              | 89    | 92    | ✓ |   |
| FIAT       | Tipo 1.9 Turbo Diesel                           | 06/89 | 96    | ✓ |   |
| FIAT       | Tipo 2.0 i.e., 2.0 16V Sport                    | 91    | 95    | ✓ |   |
| LANCIA     | Dedra 1.6 16V                                   | 97    | 99    | ✓ |   |
| LANCIA     | Dedra 1.8 i.e. 8V                               | 06/89 | 95    | ✓ |   |
| LANCIA     | Dedra 1.8 16V                                   | 96    | 99    | ✓ |   |
| LANCIA     | Dedra 1.9 Turbo Diesel                          | 06/89 | 99    | ✓ |   |
| LANCIA     | Dedra 2.0 i.e. 8V                               | 06/89 | 97    | ✓ |   |
| LANCIA     | Dedra 2.0 16V                                   | 94    | 97    | ✓ |   |
| LANCIA     | Dedra 2.0 Turbo                                 | 91    | 92    | ✓ |   |
| LANCIA     | Dedra 2.0 Turbo 4x4 Integrale                   | 91    | 96    | ✓ |   |
| LANCIA     | Delta II 1.8 i.e., 1.9 Turbo Diesel             | 93    | 99    | ✓ |   |
| LANCIA     | Delta II 2.0 16V                                | 93    | 99    | ✓ |   |

**800 400**



|            |                                     |       |       |   |   |
|------------|-------------------------------------|-------|-------|---|---|
| ALFA ROMEO | Alfa 164 2.0, 2.0 TS                | 87    | 11/93 | ✓ |   |
| FIAT       | Croma 1.6 CHT                       | 86    | 90    | ✓ |   |
| FIAT       | Croma 1.9 Turbo Diesel              | 86    | 11/92 | ✓ |   |
| FIAT       | Croma 2.0 CHT, 2.5 Diesel           | 86    | 92    | ✓ |   |
| FIAT       | Croma 2.0 i.e., 2.0 i.e. Turbo      | 86    | 11/92 | ✓ |   |
| FIAT       | Croma 2.5 Turbo Diesel              | 86    | 11/92 | ✓ |   |
| FIAT       | Tipo 1.6 AGT, DGT, 1.9 Turbo Diesel | 89    | 05/89 | ✓ |   |
| LANCIA     | Dedra 1.8 i.e. 8V, 1.9 Turbo Diesel | 01/89 | 05/89 | ✓ |   |
| LANCIA     | Dedra 2.0 i.e. 8V                   | 01/89 | 05/89 | ✓ |   |
| LANCIA     | Dedra 2.0 Turbo 4x4 Integrale       | 91    | 96    | ✓ | ✓ |
| LANCIA     | Delta Integrale 4x4                 | 01/88 | 91    | ✓ |   |
| LANCIA     | Delta Integrale Evoluzione 4x4      | 91    | 94    | ✓ | ✓ |
| LANCIA     | Prisma Integrale 4x4                | 01/88 | 89    | ✓ |   |
| LANCIA     | Thema 2.0 8V                        | 85    | 92    | ✓ |   |
| LANCIA     | Thema 2.0 8V Turbo                  | 85    | 88    | ✓ |   |
| LANCIA     | Thema 2.0 16V, 2.0 16V Turbo        | 89    | 92    | ✓ |   |
| LANCIA     | Thema 2.5 Turbo Diesel, 2.85 V6     | 85    | 92    | ✓ |   |

**800 408**



|             |                              |    |       |   |  |
|-------------|------------------------------|----|-------|---|--|
| AUTOBIANCHI | A112                         | 80 | 86    | ✓ |  |
| AUTOBIANCHI | A112 E, A112 Abarth          | 80 | 05/84 | ✓ |  |
| FIAT        | 127                          | 76 | 86    | ✓ |  |
| FIAT        | Uno 45 0.9, 1.3 Super Diesel | 83 | 92    | ✓ |  |
| FIAT        | Uno 45 1.0                   | 83 | 93    | ✓ |  |
| FIAT        | Uno 55 1.1, 1.3              | 83 | 89    | ✓ |  |
| FIAT        | Uno 60 1.1                   | 86 | 92    | ✓ |  |
| FIAT        | Uno 70 i.e. 1.4              | 83 | 93    | ✓ |  |
| FIAT        | Uno 75 i.e. 1.5              | 86 | 88    | ✓ |  |
| LANCIA      | A 112, A 112 E, A 112 Abarth | 77 | 86    | ✓ |  |
| SEAT        | 127                          | 76 | 85    | ✓ |  |
| SEAT        | 128                          | 76 | 80    | ✓ |  |
| ZASTAVA     | Yugo 45, Yugo 55             | 81 | 90    | ✓ |  |
| ZASTAVA     | Yugo 101                     | 78 | 06/82 | ✓ |  |

**801 171**



|                   |                   |    |    |   |  |
|-------------------|-------------------|----|----|---|--|
| FIAT              | 132               | 72 | 81 | ✓ |  |
| FIAT              | Argenta           | 81 | 85 | ✓ |  |
| POLSKI FIAT / FSO | 125p              | 74 | 91 | ✓ |  |
| POLSKI FIAT / FSO | FSO Polonez       | 79 | 00 | ✓ |  |
| POLSKI FIAT / FSO | FSO Polonez CARGO | 96 | 00 | ✓ |  |
| POLSKI FIAT / FSO | FSO Polonez TRUCK | 94 | 00 | ✓ |  |
| SEAT              | 132               | 72 | 82 | ✓ |  |

**801 173**



|                   |                   |    |    |   |  |
|-------------------|-------------------|----|----|---|--|
| FIAT              | 126               | 77 | 00 | ✓ |  |
| POLSKI FIAT / FSO | 126, 126 Personal | 77 | 86 | ✓ |  |
| POLSKI FIAT / FSO | 126p FL (FSM)     | 83 | 00 | ✓ |  |
| POLSKI FIAT / FSO | 126 BIS           | 87 | 92 | ✓ |  |
| SEAT              | 133               | 74 | 81 | ✓ |  |

**801 238**



|            |          |    |    |   |  |
|------------|----------|----|----|---|--|
| ALFA ROMEO | Spider I | 78 | 93 | ✓ |  |
|------------|----------|----|----|---|--|

**801 267**



|      |               |    |    |   |  |
|------|---------------|----|----|---|--|
| FIAT | Stilo 2.4 20V | 01 | 05 | ✓ |  |
|------|---------------|----|----|---|--|

**801 269**



|      |                      |       |    |   |  |
|------|----------------------|-------|----|---|--|
| FIAT | Palio, Palio Weekend | 09/01 | 05 | ✓ |  |
|------|----------------------|-------|----|---|--|

**801 342**



|             |                     |    |    |   |  |
|-------------|---------------------|----|----|---|--|
| AUTOBIANCHI | Y10                 | 85 | 92 | ✓ |  |
| AUTOBIANCHI | Y10 4x4             | 87 | 92 | ✓ |  |
| FIAT        | Panda 650           | 81 | 04 | ✓ |  |
| FIAT        | Panda 750           | 86 | 97 | ✓ |  |
| FIAT        | Panda 800           | 81 | 85 | ✓ |  |
| FIAT        | Panda 900           | 80 | 96 | ✓ |  |
| FIAT        | Panda 950           | 80 | 94 | ✓ |  |
| FIAT        | Panda 1000          | 85 | 92 | ✓ |  |
| FIAT        | Panda 1000 i.e. CAT | 87 | 98 | ✓ |  |
| FIAT        | Panda 1100, Van     | 86 | 04 | ✓ |  |
| FIAT        | Panda 1300 D        | 86 | 93 | ✓ |  |
| FIAT        | Panda 4x4           | 83 | 04 | ✓ |  |
| LANCIA      | Y 10                | 85 | 95 | ✓ |  |
| LANCIA      | Y 10 4x4            | 87 | 95 | ✓ |  |
| SEAT        | Furgoneta 903 Terra | 87 | 90 | ✓ |  |
| SEAT        | Marbella            | 86 | 98 | ✓ |  |
| SEAT        | Panda               | 80 | 85 | ✓ |  |
| SEAT        | Panda Terra, Trans  | 83 | 90 | ✓ |  |

**801 354**



|      |                 |    |    |   |  |
|------|-----------------|----|----|---|--|
| SEAT | Ibiza I, Malaga | 85 | 93 | ✓ |  |
| SEAT | Ritmo           | 78 | 82 | ✓ |  |
| SEAT | Ronda           | 83 | 86 | ✓ |  |

**801 360**



|        |                      |       |       |   |  |
|--------|----------------------|-------|-------|---|--|
| FIAT   | Tipo 1.6, 1.7 Diesel | 88    | 05/89 | ✓ |  |
| LANCIA | Dedra 1.6 i.e. 8V    | 01/89 | 05/89 | ✓ |  |

**801 362**

|        |                                   |       |       |   |  |
|--------|-----------------------------------|-------|-------|---|--|
| FIAT   | Brava 1.2 16V                     | 99    | 01    | ✓ |  |
| FIAT   | Brava 1.4 12V, 1.9 Diesel         | 95    | 98    | ✓ |  |
| FIAT   | Brava 1.6 16V                     | 95    | 01    | ✓ |  |
| FIAT   | Bravo 1.2 16VI                    | 99    | 01    | ✓ |  |
| FIAT   | Bravo 1.4 12V, 1.9 Diesel         | 95    | 98    | ✓ |  |
| FIAT   | Bravo 1.6 16V                     | 95    | 01    | ✓ |  |
| FIAT   | Marea 1.2 12V                     | 99    | 05    | ✓ |  |
| FIAT   | Marea 1.4 12V                     | 96    | 05    | ✓ |  |
| FIAT   | Punto I 60 1.2, 75 1.2 8V         | 93    | 06/00 | ✓ |  |
| FIAT   | Punto I 85 1.2 16V                | 97    | 06/00 | ✓ |  |
| FIAT   | Punto I 90 1.6                    | 93    | 98    | ✓ |  |
| FIAT   | Punto I 1.7 D                     | 94    | 00    | ✓ |  |
| FIAT   | Punto I 1.7 TD 46 kW              | 96    | 09/99 | ✓ |  |
| FIAT   | Punto I Cabriolet                 | 93    | 06/00 | ✓ |  |
| FIAT   | Punto II 1.2 8V, 1.2 16V, 1.9 DS. | 09/99 | 06    | ✓ |  |
| FIAT   | Punto II 1.4 16V                  | 03    | 06    | ✓ |  |
| LANCIA | Y                                 | 95    | 04    | ✓ |  |

**801 364**

|      |                  |    |    |   |  |
|------|------------------|----|----|---|--|
| FIAT | Punto I 55 1.1   | 93 | 99 | ✓ |  |
| FIAT | Seicento Elektra | 98 | 02 | ✓ |  |

**801 372**

|        |                              |    |    |   |  |
|--------|------------------------------|----|----|---|--|
| FIAT   | Ritmo 125 TC 2.0, 130 TC 2.0 | 82 | 87 | ✓ |  |
| LANCIA | Beta                         | 72 | 84 | ✓ |  |

**801 376**

|        |                                |       |    |   |  |
|--------|--------------------------------|-------|----|---|--|
| FIAT   | Tempra 1.4, 1.6, 1.6 Automatic | 90    | 96 | ✓ |  |
| FIAT   | Tempra 1.9 Diesel              | 90    | 96 | ✓ |  |
| FIAT   | Tipo 1.6, 1.7 Diesel           | 06/89 | 95 | ✓ |  |
| FIAT   | Tipo 1.6 Automatic             | 91    | 95 | ✓ |  |
| FIAT   | Tipo 1.9 Diesel                | 92    | 95 | ✓ |  |
| LANCIA | Dedra 1.6 i.e. 8V              | 06/89 | 97 | ✓ |  |
| LANCIA | Delta II 1.4 i.e., 1.6 i.e.    | 93    | 99 | ✓ |  |

**801 382**

|      |                 |       |    |   |  |
|------|-----------------|-------|----|---|--|
| FIAT | Uno 75 i.e. 1.5 | 12/88 | 92 | ✓ |  |
|------|-----------------|-------|----|---|--|

**801 402**

|                   |                   |    |    |   |  |
|-------------------|-------------------|----|----|---|--|
| FIAT              | 132               | 72 | 81 | ✓ |  |
| FIAT              | Argenta           | 81 | 85 | ✓ |  |
| POLSKI FIAT / FSO | 125p              | 74 | 91 | ✓ |  |
| POLSKI FIAT / FSO | FSO Polonez       | 79 | 00 | ✓ |  |
| POLSKI FIAT / FSO | FSO Polonez CARGO | 96 | 00 | ✓ |  |
| POLSKI FIAT / FSO | FSO Polonez TRUCK | 94 | 00 | ✓ |  |
| SEAT              | 132               | 72 | 82 | ✓ |  |

**801 428**

|            |                 |       |    |   |  |
|------------|-----------------|-------|----|---|--|
| ALFA ROMEO | Alfa 33, 33 4x4 | 04/89 | 94 | ✓ |  |
|------------|-----------------|-------|----|---|--|

**801 438**

|            |           |       |    |   |  |
|------------|-----------|-------|----|---|--|
| ALFA ROMEO | Alfa 75   | 05/85 | 92 | ✓ |  |
| ALFA ROMEO | Alfa 90   | 84    | 87 | ✓ |  |
| ALFA ROMEO | Alfetta   | 03/80 | 84 | ✓ |  |
| ALFA ROMEO | Giulietta | 03/80 | 85 | ✓ |  |
| ALFA ROMEO | GTV 2.0   | 85    | 87 | ✓ |  |
| ALFA ROMEO | GTV 6 2.5 | 81    | 87 | ✓ |  |

**801 442**

|            |        |    |    |   |  |
|------------|--------|----|----|---|--|
| LADA (VAZ) | Sagona | 90 | 97 | ✓ |  |
| LADA (VAZ) | Samara | 86 | 97 | ✓ |  |

**801 450**

|      |                   |    |    |   |  |
|------|-------------------|----|----|---|--|
| FIAT | Cinquecento       | 91 | 98 | ✓ |  |
| FIAT | Panda II 1.1, 1.2 | 03 | 06 | ✓ |  |
| FIAT | Seicento          | 98 | 05 | ✓ |  |
| FIAT | Tipo 1.1, 1.4     | 88 | 95 | ✓ |  |

**801 478**

|            |         |    |       |   |  |
|------------|---------|----|-------|---|--|
| ALFA ROMEO | Alfa 33 | 83 | 03/89 | ✓ |  |
|------------|---------|----|-------|---|--|

**801 478**

|            |                |    |       |   |  |
|------------|----------------|----|-------|---|--|
| ALFA ROMEO | Alfa 33 4x4    | 84 | 03/89 | ✓ |  |
| ALFA ROMEO | Alfasud Sprint | 87 | 90    | ✓ |  |
| ALFA ROMEO | Arna           | 83 | 86    | ✓ |  |

**801 500**

|            |                                   |       |       |   |  |
|------------|-----------------------------------|-------|-------|---|--|
| ALFA ROMEO | Alfa 145 1.9 JTD, 146 1.9 JTD     | 99    | 01    | ✓ |  |
| ALFA ROMEO | Alfa 155 2.0 16V Turbo Q4, 2.5 V6 | 92    | 97    | ✓ |  |
| ALFA ROMEO | Alfa 155 2.5 Turbo Diesel         | 92    | 97    | ✓ |  |
| ALFA ROMEO | Alfa 164 2.0, 2.0 TS              | 12/93 | 98    | ✓ |  |
| ALFA ROMEO | Alfa 164 2.0 Turbo                | 87    | 98    | ✓ |  |
| ALFA ROMEO | Alfa 164 2.0 V6 Turbo             | 91    | 98    | ✓ |  |
| ALFA ROMEO | Alfa 164 2.5 Turbo Diesel, 3.0 V6 | 87    | 98    | ✓ |  |
| ALFA ROMEO | Alfa 164 3.0 V6 Q4                | 94    | 98    | ✓ |  |
| ALFA ROMEO | GT 3 3.0 V6 24V                   | 97    | 04/00 | ✓ |  |
| ALFA ROMEO | GTV II 2.0 V6 Turbo, 3.0 V6 24V   | 95    | 04/00 | ✓ |  |
| ALFA ROMEO | Spider II 3.0 V6, 3.0 V6 24V      | 95    | 04/00 | ✓ |  |
| ALFA ROMEO | Spider II 2.0 V6 Turbo            | 95    | 04/00 | ✓ |  |
| FIAT       | Bravo 2.0 HGT 20V                 | 95    | 09/98 | ✓ |  |
| FIAT       | Coupé 2.0 16V Turbo               | 94    | 96    | ✓ |  |
| FIAT       | Coupé 2.0 20V Turbo               | 96    | 05    | ✓ |  |
| FIAT       | Croma 1.9 Turbo Diesel            | 11/92 | 96    | ✓ |  |
| FIAT       | Croma 2.0 i.e., 2.0 i.e. Turbo    | 11/92 | 96    | ✓ |  |
| FIAT       | Croma 2.0 16V, 2.5i V6            | 93    | 96    | ✓ |  |
| FIAT       | Croma 2.5 Turbo Diesel            | 11/92 | 96    | ✓ |  |
| FIAT       | Marea 2.0 20V, 2.0 20V Turbo      | 96    | 05    | ✓ |  |
| FIAT       | Marea 2.4 Turbo Diesel            | 96    | 99    | ✓ |  |
| FIAT       | Marea 2.4 JTD                     | 99    | 05    | ✓ |  |
| LANCIA     | Delta II 2.0 16V Turbo            | 93    | 99    | ✓ |  |
| LANCIA     | Kappa 2.0 16V, 2.0 20V, 2.4 20V   | 94    | 04/98 | ✓ |  |
| LANCIA     | Kappa 2.4 T.DS., 3.0 V6 24V       | 94    | 04/98 | ✓ |  |
| LANCIA     | Kappa Coupé 2.0 16V, 2.0 20V      | 94    | 04/98 | ✓ |  |
| LANCIA     | Kappa Coupé 2.4 20V, 3.0 V6 24V   | 94    | 04/98 | ✓ |  |
| LANCIA     | Thema 2.0 8V                      | 92    | 92    | ✓ |  |
| LANCIA     | Thema 2.0 16V, 2.0 16V Turbo      | 92    | 94    | ✓ |  |
| LANCIA     | Thema 3.0 V6                      | 93    | 95    | ✓ |  |

**801 538**

|                   |               |    |    |   |  |
|-------------------|---------------|----|----|---|--|
| FIAT              | 126           | 77 | 00 | ✓ |  |
| POLSKI FIAT / FSO | 126 Personal  | 77 | 86 | ✓ |  |
| POLSKI FIAT / FSO | 126p FL (FSM) | 83 | 00 | ✓ |  |
| POLSKI FIAT / FSO | 126 BIS       | 87 | 92 | ✓ |  |
| SEAT              | 133           | 74 | 81 | ✓ |  |
| ZASTAVA           | 750, 850      | 78 | 86 | ✓ |  |

**801 543**

|            |                       |       |    |   |  |
|------------|-----------------------|-------|----|---|--|
| SKODA      | Favorit 115, 135, 136 | 05/93 | 94 | ✓ |  |
| SKODA      | Felicia               | 94    | 01 | ✓ |  |
| SKODA      | Pick-up               | 95    | 02 | ✓ |  |
| VOLKSWAGEN | Caddy II Pick-up      | 97    | 01 | ✓ |  |

**801 554**

|            |                          |    |    |   |  |
|------------|--------------------------|----|----|---|--|
| ALFA ROMEO | Alfa 6                   | 79 | 85 | ✓ |  |
| ALFA ROMEO | Alfa 75 Turbo Evoluzione | 89 | 91 | ✓ |  |

**801 588**

|            |                |    |    |   |  |
|------------|----------------|----|----|---|--|
| ALFA ROMEO | Alfasud        | 72 | 84 | ✓ |  |
| ALFA ROMEO | Alfasud Sprint | 77 | 84 | ✓ |  |
| ALFA ROMEO | Alfasud Sprint | 85 | 87 | ✓ |  |

**801 618**

|       |                             |    |    |   |  |
|-------|-----------------------------|----|----|---|--|
| SKODA | 105 S, 105 L                | 77 | 89 | ✓ |  |
| SKODA | 120, 120 L, 120 LS, 120 GLS | 77 | 89 | ✓ |  |

**801 644**

|       |               |       |       |   |  |
|-------|---------------|-------|-------|---|--|
| IVECO | Daily I 30-8  | 10/84 | 01/97 | ✓ |  |
| IVECO | Daily I 30-9  | 10/84 | 88    | ✓ |  |
| IVECO | Daily I 35-8  | 10/84 | 99    | ✓ |  |
| IVECO | Daily I 35-9  | 06/81 | 09/84 | ✓ |  |
| IVECO | Daily I 35-10 | 06/81 | 01/97 | ✓ |  |

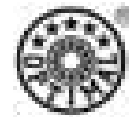

**801 644**

|       |                                 |       |       |   |  |
|-------|---------------------------------|-------|-------|---|--|
| IVECO | Daily I 40-8                    | 10/84 | 02/96 | ✓ |  |
| IVECO | Grinta                          | 06/81 | 09/84 | ✓ |  |
| IVECO | Grinta Ser S: 30-9, 35-8, 35-10 | 10/84 | 88    | ✓ |  |
| IVECO | Grinta Ser S: 40-8, 40-10       | 10/84 | 88    | ✓ |  |

**801 656**

|            |       |    |    |   |  |
|------------|-------|----|----|---|--|
| LADA (VAZ) | Niva  | 78 | 02 | ✓ |  |
| LADA (VAZ) | Taiga | 77 | 90 | ✓ |  |

**801 694**

|       |                       |    |       |   |  |
|-------|-----------------------|----|-------|---|--|
| SKODA | Favorit 115, 135, 136 | 88 | 04/93 | ✓ |  |
| SKODA | Forman                | 91 | 01    | ✓ |  |

**801 698**

|      |     |    |    |   |  |
|------|-----|----|----|---|--|
| FIAT | 131 | 75 | 84 | ✓ |  |
| SEAT | 131 | 75 | 84 | ✓ |  |

**801 730**

|      |                                   |       |    |   |  |
|------|-----------------------------------|-------|----|---|--|
| FIAT | Doblò 1.2 8V, 1.6 16V, 1.9 D      | 03/01 | 05 | ✓ |  |
| FIAT | Fiorino 1.3, 1.4, 1.6, 1.7 Diesel | 07/93 | 01 | ✓ |  |
| FIAT | Fiorino 1.7 Turbo Diesel          | 07/93 | 01 | ✓ |  |
| FIAT | Strada                            | 96    | 04 | ✓ |  |
| FIAT | Tempra 1.6 Automatic              | 90    | 96 | ✓ |  |

**801 746**

|       |     |    |    |   |  |
|-------|-----|----|----|---|--|
| IVECO | 238 | 72 | 82 | ✓ |  |
|-------|-----|----|----|---|--|

**801 750**

|       |                                 |       |       |   |  |
|-------|---------------------------------|-------|-------|---|--|
| IVECO | Daily I 30-8                    | 10/84 | 01/97 | ✓ |  |
| IVECO | Daily I 30-9                    | 10/84 | 88    | ✓ |  |
| IVECO | Daily I 35-8                    | 10/84 | 99    | ✓ |  |
| IVECO | Daily I 35-9                    | 06/81 | 09/84 | ✓ |  |
| IVECO | Daily I 35-10                   | 06/81 | 01/97 | ✓ |  |
| IVECO | Daily I 40-8                    | 10/84 | 02/96 | ✓ |  |
| IVECO | Grinta                          | 06/81 | 09/84 | ✓ |  |
| IVECO | Grinta Ser S: 30-9, 35-8, 35-10 | 10/84 | 88    | ✓ |  |
| IVECO | Grinta Ser S: 40-8, 40-10       | 10/84 | 88    | ✓ |  |

**801 829**

|        |          |       |       |   |  |
|--------|----------|-------|-------|---|--|
| FIAT   | Sedici   | 06/06 | 12/06 | ✓ |  |
| SUZUKI | Ignis II | 09/03 | 06    | ✓ |  |
| SUZUKI | SX4      | 06/06 | 12/06 | ✓ |  |
| SUZUKI | Swift SG | 05    | 06    | ✓ |  |

**801 836**

|        |                                      |       |       |   |  |
|--------|--------------------------------------|-------|-------|---|--|
| FIAT   | Brava 1.2 16V, 1.6 16V               | 99    | 01    | ✓ |  |
| FIAT   | Bravo 1.2 16V, 1.6 16V               | 99    | 01    | ✓ |  |
| FIAT   | Grande Punto 1.2 8V, 1.3 D Multijet  | 10/05 | 12/05 | ✓ |  |
| FIAT   | Grande Punto 1.4 16V, 1.9 D Multijet | 10/05 | 12/05 | ✓ |  |
| FIAT   | Idea 1.4                             | 01/04 | 05    | ✓ |  |
| FIAT   | Marea 1.2 12V                        | 99    | 05    | ✓ |  |
| FIAT   | Marea 1.4 12V                        | 98    | 05    | ✓ |  |
| FIAT   | Punto II 1.2 8V, 1.2 16V, 1.9 DS.    | 09/99 | 06    | ✓ |  |
| FIAT   | Punto II 1.4 16V                     | 03    | 06    | ✓ |  |
| FIAT   | Stilo 1.2 16V                        | 02    | 05    | ✓ |  |
| LANCIA | Musa 1.4 16V                         | 04    | 05    | ✓ |  |
| LANCIA | Y                                    | 98    | 04    | ✓ |  |
| LANCIA | Ypsilon 1.2 8V, 1.2 16V, 1.4 16V     | 10/03 | 04    | ✓ |  |

**801 838**

|            |   |       |    |   |  |
|------------|---|-------|----|---|--|
| ALFA ROMEO | Alfa 145 1.4 i.e., 1.6 i.e., 1.7 i.e., 1.8 i.e. | 10/98 | 01 | ✓ |  |
| ALFA ROMEO | Alfa 145 2.0 16V                                | 10/98 | 01 | ✓ |  |
| ALFA ROMEO | Alfa 146 1.4 i.e., 1.6 i.e., 1.7 i.e., 1.8 i.e. | 10/98 | 01 | ✓ |  |
| ALFA ROMEO | Alfa 146 2.0 16V                                | 10/98 | 01 | ✓ |  |
| ALFA ROMEO | GTV II 1.8 16V                                  | 04/00 | 06 | ✓ |  |
| ALFA ROMEO | GTV II 2.0 JTS                                  | 04/03 | 06 | ✓ |  |
| ALFA ROMEO | Spider II 1.8 16V, 2.0 TS 16V, 2.0 JTS          | 04/00 | 06 | ✓ |  |
| FIAT       | Barchetta 1.8 16V                               | 05/99 | 05 | ✓ |  |
| FIAT       | Brava 1.6 16V, 1.8 GT 16V                       | 10/98 | 01 | ✓ |  |
| FIAT       | Brava 1.9 Turbo Diesel, 1.9 JTD                 | 10/98 | 01 | ✓ |  |

**801 838**

|        |                                    |       |       |   |  |
|--------|------------------------------------|-------|-------|---|--|
| FIAT   | Bravo 1.6 16V, 1.8 GT 16V          | 10/98 | 01    | ✓ |  |
| FIAT   | Bravo 1.9 Turbo Diesel, 1.9 JTD    | 10/98 | 01    | ✓ |  |
| FIAT   | Doblò 1.2 8V, 1.6 16V, 1.9 D       | 03/01 | 05    | ✓ |  |
| FIAT   | Doblò 1.3 JTD                      | 05/04 | 05    | ✓ |  |
| FIAT   | Doblò 1.9 JTD                      | 10/01 | 05    | ✓ |  |
| FIAT   | Idea 1.2 16V, 1.3 JTD, 1.9 JTD     | 01/04 | 05    | ✓ |  |
| FIAT   | Idea 1.3 D Multijet                | 10/05 | 12/05 | ✓ |  |
| FIAT   | Marea 1.6 16V, 1.8 16V             | 98    | 05    | ✓ |  |
| FIAT   | Marea 1.9 Turbo Diesel, 1.9 JTD    | 98    | 05    | ✓ |  |
| FIAT   | Multipla                           | 99    | 05    | ✓ |  |
| FIAT   | Panda II 1.2 4x4, 1.3 JTD 4x4      | 04    | 06    | ✓ |  |
| FIAT   | Panda II 1.3 JTD, Punto II 1.3 JTD | 03    | 06    | ✓ |  |
| FIAT   | Punto II 1.8 16V HGT               | 09/99 | 06    | ✓ |  |
| FIAT   | Punto II 1.9 JTD                   | 01    | 06    | ✓ |  |
| FIAT   | Strada                             | 96    | 04    | ✓ |  |
| LANCIA | Lybra 1.6 16V, 1.8 16V             | 99    | 05    | ✓ |  |
| LANCIA | Musa 1.3 Multijet, 1.9 Multijet    | 04    | 05    | ✓ |  |
| LANCIA | Ypsilon 1.3 JTD                    | 10/03 | 04    | ✓ |  |

**801 880**

|      |                      |    |    |   |  |
|------|----------------------|----|----|---|--|
| FIAT | Palio, Palio Weekend | 97 | 05 | ✓ |  |
| FIAT | Siena                | 97 | 06 | ✓ |  |

**801 922**

|                   |     |    |    |   |  |
|-------------------|-----|----|----|---|--|
| POLSKI FIAT / FSO | 126 | 72 | 76 | ✓ |  |
|-------------------|-----|----|----|---|--|

**801 950**

|      |                               |    |    |   |   |
|------|-------------------------------|----|----|---|---|
| FIAT | Panda II 1.1, 1.2             | 03 | 06 | ✓ |   |
| FIAT | Panda II 1.2 4x4, 1.3 JTD 4x4 | 04 | 06 | ✓ | ✓ |
| FIAT | Seicento                      | 98 | 05 | ✓ |   |

**801 961**

|            |                                       |    |    |   |  |
|------------|---------------------------------------|----|----|---|--|
| ALFA ROMEO | Alfa 147 1.6 TS16V, 1.9 JTD, 2.0 TS16 | 01 | 06 | ✓ |  |
|------------|---------------------------------------|----|----|---|--|

**801 970**

|            |                                      |    |    |   |  |
|------------|--------------------------------------|----|----|---|--|
| ALFA ROMEO | Alfa 147 3.2 GTA                     | 03 | 06 | ✓ |  |
| ALFA ROMEO | Alfa 156                             | 97 | 06 | ✓ |  |
| ALFA ROMEO | Alfa 166                             | 98 | 06 | ✓ |  |
| ALFA ROMEO | GT 1.8 TS, 1.9 JTD, 2.0 JTS, 3.2 GTA | 03 | 06 | ✓ |  |
| LANCIA     | Thesis 2.0 20V Turbo, 2.4 20V        | 02 | 05 | ✓ |  |
| LANCIA     | Thesis 2.4 JTD, 3.0 V6 24V           | 02 | 05 | ✓ |  |
| LANCIA     | Thesis 3.2 V6 24V                    | 03 | 05 | ✓ |  |

**801 972**

|            |                                 |       |       |   |  |
|------------|---------------------------------|-------|-------|---|--|
| ALFA ROMEO | Alfa 145 1.9 JTD, 146 1.9 JTD   | 10/98 | 01    | ✓ |  |
| ALFA ROMEO | GTV II 2.0 TS 16V, 2.0 V6 Turbo | 04/00 | 06    | ✓ |  |
| ALFA ROMEO | GTV II 3.0 V6 24V               | 04/00 | 06    | ✓ |  |
| ALFA ROMEO | GTV II 3.2 V6 24V               | 04/03 | 06    | ✓ |  |
| ALFA ROMEO | Spider II 2.0 V6 Turbo, 3.0 V6  | 04/00 | 06    | ✓ |  |
| ALFA ROMEO | Spider II 3.0 V6 24V            | 04/00 | 06    | ✓ |  |
| ALFA ROMEO | Spider II 3.2 V6 24V            | 04/03 | 06    | ✓ |  |
| FIAT       | Bravo 2.0 HGT 20V               | 10/98 | 01    | ✓ |  |
| FIAT       | Marea 2.0 20V, 2.0 20V Turbo    | 98    | 05    | ✓ |  |
| FIAT       | Marea 2.4 Turbo Diesel          | 98    | 99    | ✓ |  |
| FIAT       | Marea 2.4 JTD                   | 99    | 05    | ✓ |  |
| LANCIA     | Kappa 2.0 16V, 2.0 20V, 2.4 20V | 04/98 | 10/01 | ✓ |  |
| LANCIA     | Kappa 2.4 JTD, 3.0 V6 24V       | 04/98 | 10/01 | ✓ |  |
| LANCIA     | Kappa Coupé 2.0 16V, 2.0 20V    | 04/98 | 10/01 | ✓ |  |
| LANCIA     | Kappa Coupé 2.4 20V, 3.0 V6 24V | 04/98 | 10/01 | ✓ |  |
| LANCIA     | Lybra 1.9 JTD, 2.0 20V, 2.4 JTD | 99    | 05    | ✓ |  |

**801 974**

|      |                                    |    |    |   |  |
|------|------------------------------------|----|----|---|--|
| FIAT | Stilo 1.4 16V, SW 1.4 16V          | 04 | 05 | ✓ |  |
| FIAT | Stilo 1.6 16V, 1.8 16V, 1.9 JDT    | 01 | 05 | ✓ |  |
| FIAT | Stilo SW 1.6 16V, 1.8 16V, 1.9 JDT | 03 | 05 | ✓ |  |

**802 233**

|        |                               |    |    |   |  |
|--------|-------------------------------|----|----|---|--|
| LANCIA | Thesis 2.0 20V Turbo, 2.4 20V | 02 | 05 | ✓ |  |
| LANCIA | Thesis 2.4 JTD, 3.0 V6 24V    | 02 | 05 | ✓ |  |



**802 233**

|        |                   |    |    |  |   |
|--------|-------------------|----|----|--|---|
| LANCIA | Thesis 3.2 V6 24V | 03 | 05 |  | ✓ |
|--------|-------------------|----|----|--|---|

**802 265**

|      |                                    |    |    |  |   |
|------|------------------------------------|----|----|--|---|
| FIAT | Stilo SW 1.4 16V                   | 04 | 05 |  | ✓ |
| FIAT | Stilo SW 1.6 16V, 1.8 16V, 1.9 JDT | 03 | 05 |  | ✓ |

**802 271**

|      |                              |       |    |  |   |
|------|------------------------------|-------|----|--|---|
| FIAT | Doblò 1.2 8V, 1.6 16V, 1.9 D | 03/01 | 05 |  | ✓ |
| FIAT | Doblò 1.3 JTD                | 05/04 | 05 |  | ✓ |
| FIAT | Doblò 1.9 JTD                | 10/01 | 05 |  | ✓ |

**802 315**

|            |                                     |       |       |  |   |
|------------|-------------------------------------|-------|-------|--|---|
| ALFA ROMEO | Alfa 145, 146                       | 02/96 | 10/98 |  | ✓ |
| FIAT       | Barchetta 1.8 16V                   | 96    | 05/99 |  | ✓ |
| FIAT       | Brava 1.4 12V, 1.9 Diesel           | 95    | 98    |  | ✓ |
| FIAT       | Brava 1.6 16V, 1.8 GT 16V           | 95    | 09/98 |  | ✓ |
| FIAT       | Brava 1.9 Turbo Diesel              | 95    | 09/98 |  | ✓ |
| FIAT       | Bravo 1.4 12V, 1.9 Diesel           | 95    | 98    |  | ✓ |
| FIAT       | Bravo 1.6 16V, 1.8 GT 16V           | 95    | 09/98 |  | ✓ |
| FIAT       | Bravo 1.9 Turbo Diesel              | 95    | 09/98 |  | ✓ |
| FIAT       | Bravo 2.0 HGT 20V                   | 95    | 09/98 |  | ✓ |
| FIAT       | Marea 1.4 12V, 1.6 16V, 1.8 16V     | 96    | 98    |  | ✓ |
| FIAT       | Marea 1.9 Turbo Diesel              | 96    | 98    |  | ✓ |
| FIAT       | Marea 2.0 20V, 2.0 20V Turbo        | 96    | 98    |  | ✓ |
| FIAT       | Marea 2.4 Turbo Diesel              | 96    | 98    |  | ✓ |
| FIAT       | Palio, Palio Weekend                | 97    | 09/01 |  | ✓ |
| FIAT       | Punto I 55 1.1, 90 1.6              | 93    | 99    |  | ✓ |
| FIAT       | Punto I 60 1.2, 75 1.2 8V           | 93    | 06/00 |  | ✓ |
| FIAT       | Punto I 85 1.2 16V                  | 97    | 06/00 |  | ✓ |
| FIAT       | Punto I 1.4 GT Turbo                | 93    | 09/99 |  | ✓ |
| FIAT       | Punto I 1.7 D                       | 94    | 00    |  | ✓ |
| FIAT       | Punto I 1.7 TD (46kW, 51 kW, 52 kW) | 94    | 00    |  | ✓ |
| FIAT       | Punto I Cabriolet                   | 93    | 06/00 |  | ✓ |
| FIAT       | Siena                               | 97    | 06    |  | ✓ |
| LANCIA     | Y                                   | 95    | 98    |  | ✓ |

**802 318**

|             |                                      |    |       |  |   |
|-------------|--------------------------------------|----|-------|--|---|
| AUTOBIANCHI | A112, A112 E, A112 Abarth            | 80 | 05/84 |  | ✓ |
| FIAT        | 127                                  | 76 | 86    |  | ✓ |
| FIAT        | 128                                  | 80 | 84    |  | ✓ |
| FIAT        | Duna 60 1.1, 70 1.3, DS 1.7, Weekend | 87 | 93    |  | ✓ |
| FIAT        | Regata 1.3, 1.5, 1.6                 | 83 | 05/84 |  | ✓ |
| FIAT        | Ritmo 60, 65, 70, 75, 85, 105 TC 1.6 | 78 | 05/84 |  | ✓ |
| FIAT        | Ritmo Diesel 1.7, Turbo Diesel 1.9   | 78 | 05/84 |  | ✓ |
| FIAT        | Uno 45 0.9, 1.0, 1.3 Super Diesel    | 83 | 92    |  | ✓ |
| FIAT        | Uno 55 1.1, 70 1.3                   | 83 | 89    |  | ✓ |
| FIAT        | Uno 60 1.1, CS 1.1                   | 86 | 92    |  | ✓ |
| FIAT        | Uno 70 i.e. 1.4                      | 83 | 93    |  | ✓ |
| FIAT        | Uno 1.4 Turbo Diesel                 | 86 | 95    |  | ✓ |
| FIAT        | Uno 75 i.e. 1.5                      | 86 | 92    |  | ✓ |
| FIAT        | Uno 1.7 Diesel                       | 87 | 95    |  | ✓ |
| FIAT        | Uno 1.7 Diesel CS                    | 86 | 95    |  | ✓ |
| FIAT        | Uno 1.9 Diesel                       | 90 | 95    |  | ✓ |
| LANCIA      | A 112, A 112 E, A 112 Abarth         | 77 | 05/84 |  | ✓ |
| LANCIA      | Delta I 1.3, 1.5                     | 80 | 05/84 |  | ✓ |
| LANCIA      | Prisma 1.3, 1.5                      | 83 | 05/84 |  | ✓ |
| SAAB        | 600 1.5                              | 80 | 05/84 |  | ✓ |
| SEAT        | 127                                  | 76 | 85    |  | ✓ |
| SEAT        | 128                                  | 76 | 80    |  | ✓ |
| SEAT        | Ibiza I, Malaga                      | 85 | 93    |  | ✓ |
| SEAT        | Ritmo                                | 78 | 82    |  | ✓ |
| SEAT        | Ronda                                | 83 | 86    |  | ✓ |
| ZASTAVA     | Yugo 45, Yugo 55                     | 81 | 90    |  | ✓ |
| ZASTAVA     | Yugo 101                             | 78 | 90    |  | ✓ |

**802 324**

|             |             |       |    |  |   |
|-------------|-------------|-------|----|--|---|
| AUTOBIANCHI | A112        | 06/84 | 86 |  | ✓ |
| AUTOBIANCHI | Y10         | 85    | 92 |  | ✓ |
| FIAT        | Cinquecento | 91    | 98 |  | ✓ |

**802 324**

|        |                               |       |    |  |   |
|--------|-------------------------------|-------|----|--|---|
| FIAT   | Panda 650                     | 86    | 04 |  | ✓ |
| FIAT   | Panda 750                     | 86    | 97 |  | ✓ |
| FIAT   | Panda 900                     | 86    | 96 |  | ✓ |
| FIAT   | Panda 1000                    | 86    | 92 |  | ✓ |
| FIAT   | Panda 1000 i.e. CAT           | 87    | 98 |  | ✓ |
| FIAT   | Panda 1100                    | 86    | 04 |  | ✓ |
| FIAT   | Panda 1300 D                  | 86    | 93 |  | ✓ |
| FIAT   | Panda Van                     | 86    | 04 |  | ✓ |
| FIAT   | Regata 1.3, 1.5, 1.6          | 06/84 | 90 |  | ✓ |
| FIAT   | Regata 1.7 Diesel, 1.9 Diesel | 86    | 90 |  | ✓ |
| FIAT   | Ritmo 60, 65, 70, 75, 85      | 06/84 | 87 |  | ✓ |
| FIAT   | Ritmo 105 TC 1.6, Diesel 1.7  | 06/84 | 87 |  | ✓ |
| FIAT   | Ritmo Turbo Diesel 1.9        | 06/84 | 87 |  | ✓ |
| FIAT   | Seicento                      | 98    | 05 |  | ✓ |
| LANCIA | A 112, A 112 E, A 112 Abarth  | 05/84 | 86 |  | ✓ |
| LANCIA | Delta I 1.3, 1.5              | 05/84 | 92 |  | ✓ |
| LANCIA | Prisma 1.3, 1.5               | 06/84 | 89 |  | ✓ |
| LANCIA | Y 10                          | 85    | 95 |  | ✓ |
| SAAB   | 600 1.5                       | 06/84 | 87 |  | ✓ |

**802 330**

|            |   |       |       |  |   |
|------------|---|-------|-------|--|---|
| ALFA ROMEO | Alfa 145  | 94    | 98    |  | ✓ |
| ALFA ROMEO | Alfa 145 1.4 i.e., 1.6 i.e., 1.7 i.e., 1.8 i.e. | 99    | 01    |  | ✓ |
| ALFA ROMEO | Alfa 145 1.9 JTD, 2.0 16V                       | 99    | 01    |  | ✓ |
| ALFA ROMEO | Alfa 146  | 94    | 98    |  | ✓ |
| ALFA ROMEO | Alfa 146 1.4 i.e., 1.6 i.e., 1.7 i.e., 1.8 i.e. | 99    | 01    |  | ✓ |
| ALFA ROMEO | Alfa 146 1.9 JTD, 2.0 16V                       | 99    | 01    |  | ✓ |
| ALFA ROMEO | Alfa 155 1.6 TS, 1.6 TS 16V                     | 92    | 98    |  | ✓ |
| ALFA ROMEO | Alfa 155 1.7 TS, 1.7 TS 16V                     | 92    | 97    |  | ✓ |
| ALFA ROMEO | Alfa 155 1.8 TS, 1.8 TS 16V                     | 92    | 97    |  | ✓ |
| ALFA ROMEO | Alfa 155 1.9 Turbo Diesel                       | 92    | 97    |  | ✓ |
| ALFA ROMEO | Alfa 155 2.0 TS, 2.0 TS 16V                     | 92    | 97    |  | ✓ |
| ALFA ROMEO | Alfa 155 2.5 V6, 2.5 Turbo Diesel               | 92    | 97    |  | ✓ |
| FIAT       | Barchetta 1.8 16V                               | 95    | 04    |  | ✓ |
| FIAT       | Brava 1.2 16V                                   | 99    | 01    |  | ✓ |
| FIAT       | Brava 1.4 12V, 1.9 Diesel                       | 95    | 98    |  | ✓ |
| FIAT       | Brava 1.6 16V, 1.8 GT 16V                       | 95    | 01    |  | ✓ |
| FIAT       | Brava 1.9 Turbo Diesel                          | 95    | 01    |  | ✓ |
| FIAT       | Brava 1.9 JTD                                   | 10/98 | 01    |  | ✓ |
| FIAT       | Bravo 1.2 16V                                   | 99    | 01    |  | ✓ |
| FIAT       | Bravo 1.4 12V, 1.9 Diesel                       | 95    | 98    |  | ✓ |
| FIAT       | Bravo 1.6 16V, 1.8 GT 16V                       | 95    | 01    |  | ✓ |
| FIAT       | Bravo 1.9 Turbo Diesel                          | 95    | 01    |  | ✓ |
| FIAT       | Bravo 1.9 JTD                                   | 10/98 | 01    |  | ✓ |
| FIAT       | Bravo 2.0 HGT 20V                               | 95    | 09/98 |  | ✓ |
| FIAT       | Coupé 1.8 16V, 2.0 16V, 2.0 20V                 | 94    | 05    |  | ✓ |
| FIAT       | Coupé 2.0 16V Turbo                             | 94    | 05    |  | ✓ |
| FIAT       | Marea 1.2 12V, 1.4 12V, 1.6 16V                 | 99    | 05    |  | ✓ |
| FIAT       | Marea 1.8 16V, 1.9 Turbo Diesel                 | 96    | 05    |  | ✓ |
| FIAT       | Marea 1.9 JTD                                   | 98    | 05    |  | ✓ |
| FIAT       | Marea 2.0 20V, 2.0 20V Turbo                    | 96    | 05    |  | ✓ |
| FIAT       | Marea 2.4 Turbo Diesel                          | 96    | 99    |  | ✓ |
| FIAT       | Marea 2.4 JTD                                   | 99    | 05    |  | ✓ |
| FIAT       | Multipla  | 99    | 05    |  | ✓ |
| FIAT       | Palio, Palio Weekend                            | 97    | 05    |  | ✓ |
| FIAT       | Panda II 1.1, 1.2, 1.3 JTD                      | 03    | 06    |  | ✓ |
| FIAT       | Punto I 55 1.1                                  | 93    | 99    |  | ✓ |
| FIAT       | Punto I 60 1.2, 75 1.2 8V, 85 1.2 16V           | 93    | 06/00 |  | ✓ |
| FIAT       | Punto I 1.4 GT Turbo                            | 93    | 09/99 |  | ✓ |
| FIAT       | Punto I 90 1.6                                  | 93    | 98    |  | ✓ |
| FIAT       | Punto I 1.7 D                                   | 94    | 00    |  | ✓ |
| FIAT       | Punto I 1.7 TD (46kW, 51kW, 52 kW)              | 94    | 00    |  | ✓ |
| FIAT       | Punto I Cabriolet                               | 93    | 06/00 |  | ✓ |
| FIAT       | Punto II 1.2 8V, 1.2 16V                        | 09/99 | 06    |  | ✓ |
| FIAT       | Punto II 1.3 JTD, 1.4 16V                       | 03    | 06    |  | ✓ |
| FIAT       | Punto II 1.8 16V HGT, 1.9 DS.                   | 09/99 | 06    |  | ✓ |
| FIAT       | Punto II 1.9 JTD                                | 01    | 06    |  | ✓ |
| FIAT       | Siena   | 97    | 06    |  | ✓ |

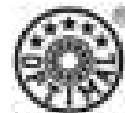

**802 330**



|        |                                       |       |       |   |
|--------|---------------------------------------|-------|-------|---|
| FIAT   | Strada                                | 96    | 04    | ✓ |
| FIAT   | Tempra 1.4, 1.6, 1.6 Automatic        | 90    | 92    | ✓ |
| FIAT   | Tempra 1.8 i.e., 1.9 Diesel           | 90    | 96    | ✓ |
| FIAT   | Tempra 1.9 Turbo Diesel, 2.0 i.e.     | 90    | 96    | ✓ |
| FIAT   | Tipo 1.1, 1.4, 1.6, 1.7 Diesel        | 88    | 95    | ✓ |
| FIAT   | Tipo 1.1, 1.4                         | 88    | 02/93 | ✓ |
| FIAT   | Tipo 1.6 AGT, DGT                     | 89    | 90    | ✓ |
| FIAT   | Tipo 1.6 Automatic, 1.8 i.e.          | 91    | 95    | ✓ |
| FIAT   | Tipo 1.8 16V Sport                    | 89    | 92    | ✓ |
| FIAT   | Tipo 1.9 Diesel                       | 92    | 95    | ✓ |
| FIAT   | Tipo 1.9 Turbo Diesel                 | 88    | 96    | ✓ |
| FIAT   | Tipo 2.0 i.e., 2.0 16V Sport          | 91    | 95    | ✓ |
| LANCIA | Dedra 1.6 i.e. 8V, 2.0 i.e. 8V        | 01/89 | 97    | ✓ |
| LANCIA | Dedra 1.6 16V                         | 97    | 99    | ✓ |
| LANCIA | Dedra 1.8 i.e. 8V                     | 01/89 | 95    | ✓ |
| LANCIA | Dedra 1.8 16V                         | 96    | 99    | ✓ |
| LANCIA | Dedra 1.9 Turbo Diesel                | 01/89 | 99    | ✓ |
| LANCIA | Dedra 2.0 Turbo                       | 91    | 92    | ✓ |
| LANCIA | Delta II 1.4 i.e., 1.6 i.e., 1.8 i.e. | 93    | 99    | ✓ |
| LANCIA | Delta II 1.9 Turbo Diesel, 2.0 16V    | 93    | 99    | ✓ |
| LANCIA | Delta II 2.0 16V Turbo                | 93    | 99    | ✓ |
| LANCIA | Y                                     | 95    | 04    | ✓ |

**802 331**



|        |                                 |    |       |   |
|--------|---------------------------------|----|-------|---|
| LANCIA | Kappa 2.0 16V, 2.0 20V, 2.4 20V | 94 | 04/98 | ✓ |
| LANCIA | Kappa 2.4 T.DS., 3.0 V6 24V     | 94 | 04/98 | ✓ |
| LANCIA | Kappa Coupé 2.0 16V, 2.0 20V    | 94 | 04/98 | ✓ |
| LANCIA | Kappa Coupé 2.4 20V, 3.0 V6 24V | 94 | 04/98 | ✓ |

**802 335**



|            |                                   |    |    |   |
|------------|-----------------------------------|----|----|---|
| ALFA ROMEO | Alfa 164 2.0 V6 Turbo             | 91 | 98 | ✓ |
| ALFA ROMEO | Alfa 164 2.5 Turbo Diesel, 3.0 V6 | 93 | 98 | ✓ |

**802 368**



|            |                                 |    |    |   |
|------------|---------------------------------|----|----|---|
| ALFA ROMEO | Alfa 164 2.0, 2.0 TS            | 87 | 92 | ✓ |
| FIAT       | Croma 1.6 CHT                   | 86 | 90 | ✓ |
| FIAT       | Croma 1.9 Turbo Diesel          | 86 | 96 | ✓ |
| FIAT       | Croma 2.0 CHT                   | 86 | 92 | ✓ |
| FIAT       | Croma 2.0 i.e., 2.0 i.e. Turbo  | 86 | 96 | ✓ |
| FIAT       | Croma 2.0 16V                   | 93 | 96 | ✓ |
| FIAT       | Croma 2.5 Diesel                | 86 | 90 | ✓ |
| FIAT       | Croma 2.5 Turbo Diesel          | 86 | 96 | ✓ |
| LANCIA     | Thema 2.0 8V, 16V               | 85 | 92 | ✓ |
| LANCIA     | Thema 2.0 8V Turbo              | 85 | 88 | ✓ |
| LANCIA     | Thema 2.0 16V Turbo             | 89 | 92 | ✓ |
| LANCIA     | Thema 2.5 Turbo Diesel, 2.85 V6 | 85 | 92 | ✓ |

**802 370**



|            |                                |    |       |   |
|------------|--------------------------------|----|-------|---|
| ALFA ROMEO | Alfa 164 2.0, 2.0 TS           | 87 | 92    | ✓ |
| FIAT       | Croma 1.9 Turbo Diesel         | 86 | 11/92 | ✓ |
| FIAT       | Croma 2.0 CHT, 2.5 Diesel      | 86 | 90    | ✓ |
| FIAT       | Croma 2.0 i.e., 2.0 i.e. Turbo | 86 | 11/92 | ✓ |
| FIAT       | Croma 2.5 Turbo Diesel         | 86 | 11/92 | ✓ |
| LANCIA     | Thema 2.0 8V                   | 85 | 92    | ✓ |
| LANCIA     | Thema 2.0 8V Turbo             | 85 | 88    | ✓ |
| LANCIA     | Thema 2.0 16V, 2.0 16V Turbo   | 89 | 92    | ✓ |
| LANCIA     | Thema 2.5 Turbo Diesel         | 85 | 08/92 | ✓ |
| LANCIA     | Thema 2.85 V6                  | 85 | 92    | ✓ |

**802 378**



|            |                                 |    |       |   |
|------------|---------------------------------|----|-------|---|
| ALFA ROMEO | Alfa 145, 146                   | 94 | 01/96 | ✓ |
| ALFA ROMEO | Alfa 155 1.6 TS, 1.6 TS 16V     | 92 | 98    | ✓ |
| ALFA ROMEO | Alfa 155 1.7 TS, 1.7 TS 16V     | 92 | 97    | ✓ |
| ALFA ROMEO | Alfa 155 1.8 TS, 1.8 TS 16V     | 92 | 97    | ✓ |
| ALFA ROMEO | Alfa 155 1.9 Turbo Diesel       | 92 | 97    | ✓ |
| ALFA ROMEO | Alfa 155 2.0 TS, 2.0 TS 16V     | 92 | 97    | ✓ |
| ALFA ROMEO | Alfa 155 2.5 V6                 | 92 | 97    | ✓ |
| ALFA ROMEO | Alfa 155 2.5 Turbo Diesel       | 92 | 97    | ✓ |
| FIAT       | Coupé 1.8 16V, 2.0 16V, 2.0 20V | 94 | 05    | ✓ |

**802 378**



|        |                                       |       |    |   |
|--------|---------------------------------------|-------|----|---|
| FIAT   | Coupé 2.0 16V Turbo                   | 94    | 96 | ✓ |
| FIAT   | Coupé 2.0 20V Turbo                   | 96    | 05 | ✓ |
| FIAT   | Tempra 1.4, 1.6, 1.6 Automatic        | 93    | 96 | ✓ |
| FIAT   | Tempra 1.8 i.e., 1.9 Diesel, 2.0 i.e. | 90    | 96 | ✓ |
| FIAT   | Tempra 1.9 Turbo Diesel               | 90    | 96 | ✓ |
| FIAT   | Tipo 1.1, 1.4, 1.6, 1.8 i.e.          | 03/93 | 95 | ✓ |
| FIAT   | Tipo 1.6 Automatic                    | 91    | 95 | ✓ |
| FIAT   | Tipo 1.7 Diesel, 1.9 Diesel           | 04/93 | 95 | ✓ |
| FIAT   | Tipo 1.8 16V Sport                    | 89    | 92 | ✓ |
| FIAT   | Tipo 1.9 Turbo Diesel                 | 88    | 96 | ✓ |
| FIAT   | Tipo 2.0 i.e.                         | 03/93 | 95 | ✓ |
| FIAT   | Tipo 2.0 16V Sport                    | 91    | 95 | ✓ |
| LANCIA | Dedra 1.6 i.e. 8V                     | 02/93 | 97 | ✓ |
| LANCIA | Dedra 1.6 16V                         | 97    | 99 | ✓ |
| LANCIA | Dedra 1.8 i.e. 8V                     | 02/93 | 95 | ✓ |
| LANCIA | Dedra 1.8 16V                         | 96    | 99 | ✓ |
| LANCIA | Dedra 1.9 Turbo Diesel                | 01/89 | 99 | ✓ |
| LANCIA | Dedra 2.0 i.e. 8V                     | 01/89 | 97 | ✓ |
| LANCIA | Dedra 2.0 16V                         | 94    | 97 | ✓ |
| LANCIA | Dedra 2.0 Turbo                       | 91    | 92 | ✓ |
| LANCIA | Delta II 1.4 i.e., 1.6 i.e., 1.8 i.e. | 93    | 99 | ✓ |
| LANCIA | Delta II 1.9 Turbo Diesel             | 93    | 99 | ✓ |
| LANCIA | Delta II 2.0 16V, 2.0 16V Turbo       | 93    | 99 | ✓ |

**802 394**



|      |                |    |    |   |
|------|----------------|----|----|---|
| FIAT | Panda 650, 800 | 81 | 85 | ✓ |
| FIAT | Panda 900      | 80 | 85 | ✓ |
| FIAT | Panda 950      | 80 | 94 | ✓ |
| FIAT | Panda 1000     | 85 | 85 | ✓ |
| SEAT | Marbella       | 86 | 98 | ✓ |
| SEAT | Panda          | 80 | 85 | ✓ |

**802 444**



|             |           |    |    |   |
|-------------|-----------|----|----|---|
| AUTOBIANCHI | Y10 4x4   | 87 | 92 | ✓ |
| FIAT        | Panda 4x4 | 83 | 04 | ✓ |
| LANCIA      | Y 10 4x4  | 87 | 95 | ✓ |

**802 454**



|                   |                        |    |    |   |
|-------------------|------------------------|----|----|---|
| LADA (VAZ)        | 1200, 1300, 1500, 1600 | 71 | 93 | ✓ |
| POLSKI FIAT / FSO | 125p                   | 74 | 91 | ✓ |
| POLSKI FIAT / FSO | FSO Polonez            | 79 | 00 | ✓ |

**802 464**



|                   |                   |    |    |   |
|-------------------|-------------------|----|----|---|
| FIAT              | 126               | 77 | 00 | ✓ |
| POLSKI FIAT / FSO | 126, 126 Personal | 77 | 86 | ✓ |
| POLSKI FIAT / FSO | 126p FL (FSM)     | 83 | 00 | ✓ |
| POLSKI FIAT / FSO | 126 BIS           | 87 | 92 | ✓ |
| ZASTAVA           | 750, 850          | 78 | 81 | ✓ |

**802 480**



|      |            |    |    |   |
|------|------------|----|----|---|
| FIAT | 131        | 75 | 84 | ✓ |
| FIAT | 132        | 72 | 81 | ✓ |
| FIAT | Argenta    | 81 | 85 | ✓ |
| SEAT | 124, 124 D | 68 | 80 | ✓ |
| SEAT | 131        | 75 | 84 | ✓ |
| SEAT | 132        | 72 | 82 | ✓ |

**802 485**



|            |                                 |    |       |   |
|------------|---------------------------------|----|-------|---|
| ALFA ROMEO | GT 3 3.0 V6 24V                 | 97 | 04/00 | ✓ |
| ALFA ROMEO | GTV II 1.8 16V, 2.0 TS 16V      | 95 | 04/00 | ✓ |
| ALFA ROMEO | GTV II 2.0 V6 Turbo, 3.0 V6 24V | 95 | 04/00 | ✓ |
| ALFA ROMEO | Spider II 1.8 16V, 2.0 TS 16V   | 95 | 04/00 | ✓ |
| ALFA ROMEO | Spider II 2.0 V6 Turbo, 3.0 V6  | 95 | 04/00 | ✓ |
| ALFA ROMEO | Spider II 3.0 V6 24V            | 95 | 04/00 | ✓ |

**802 488**



|            |             |    |       |   |
|------------|-------------|----|-------|---|
| ALFA ROMEO | Alfa 33 4x4 | 84 | 05/91 | ✓ |
|------------|-------------|----|-------|---|

**802 526**

|            |                                |       |    |  |   |
|------------|--------------------------------|-------|----|--|---|
| ALFA ROMEO | Alfa 164 2.0, 2.0 TS           | 01/93 | 98 |  | ✓ |
| FIAT       | Croma 1.9 Turbo Diesel         | 11/92 | 96 |  | ✓ |
| FIAT       | Croma 2.0 CHT                  | 91    | 92 |  | ✓ |
| FIAT       | Croma 2.0 i.e., 2.0 i.e. Turbo | 11/92 | 96 |  | ✓ |
| FIAT       | Croma 2.0 16V, 2.5i V6         | 93    | 96 |  | ✓ |
| FIAT       | Croma 2.5 Turbo Diesel         | 11/92 | 96 |  | ✓ |
| LANCIA     | Thema 2.0 8V                   | 92    | 92 |  | ✓ |
| LANCIA     | Thema 2.0 16V, 2.0 16V Turbo   | 92    | 94 |  | ✓ |
| LANCIA     | Thema 2.5 Turbo Diesel         | 09/92 | 93 |  | ✓ |
| LANCIA     | Thema 3.0 V6                   | 93    | 95 |  | ✓ |

**802 528**

|            |             |       |    |  |   |
|------------|-------------|-------|----|--|---|
| ALFA ROMEO | Alfa 33 4x4 | 06/91 | 94 |  | ✓ |
|------------|-------------|-------|----|--|---|

**802 540**

|            |                    |       |    |  |   |
|------------|--------------------|-------|----|--|---|
| ALFA ROMEO | Alfa 75            | 10/85 | 92 |  | ✓ |
| ALFA ROMEO | Alfa 90            | 10/85 | 87 |  | ✓ |
| ALFA ROMEO | GTV 2.0, GTV 6 2.5 | 85    | 87 |  | ✓ |

**802 542**

|            |                    |       |    |  |   |
|------------|--------------------|-------|----|--|---|
| ALFA ROMEO | Alfa 75            | 10/85 | 92 |  | ✓ |
| ALFA ROMEO | Alfa 90            | 10/85 | 87 |  | ✓ |
| ALFA ROMEO | GTV 2.0, GTV 6 2.5 | 85    | 87 |  | ✓ |

**802 556**

|            |           |       |       |  |   |
|------------|-----------|-------|-------|--|---|
| ALFA ROMEO | Alfa 6    | 79    | 85    |  | ✓ |
| ALFA ROMEO | Alfa 75   | 05/85 | 09/85 |  | ✓ |
| ALFA ROMEO | Alfa 90   | 84    | 09/85 |  | ✓ |
| ALFA ROMEO | Alfetta   | 03/80 | 84    |  | ✓ |
| ALFA ROMEO | Giulietta | 03/80 | 85    |  | ✓ |
| ALFA ROMEO | GTV 6 2.5 | 81    | 84    |  | ✓ |

**802 558**

|            |           |       |       |  |   |
|------------|-----------|-------|-------|--|---|
| ALFA ROMEO | Alfa 6    | 79    | 85    |  | ✓ |
| ALFA ROMEO | Alfa 75   | 05/85 | 09/85 |  | ✓ |
| ALFA ROMEO | Alfa 90   | 84    | 09/85 |  | ✓ |
| ALFA ROMEO | Alfetta   | 03/80 | 84    |  | ✓ |
| ALFA ROMEO | Giulietta | 03/80 | 85    |  | ✓ |
| ALFA ROMEO | GTV 6 2.5 | 81    | 84    |  | ✓ |

**802 560**

|            |                                   |    |    |  |   |
|------------|-----------------------------------|----|----|--|---|
| ALFA ROMEO | Alfa 164 2.0 Turbo                | 87 | 98 |  | ✓ |
| ALFA ROMEO | Alfa 164 2.5 Turbo Diesel, 3.0 V6 | 87 | 92 |  | ✓ |

**802 562**

|            |                                   |    |    |  |   |
|------------|-----------------------------------|----|----|--|---|
| ALFA ROMEO | Alfa 164 2.5 Turbo Diesel, 3.0 V6 | 87 | 92 |  | ✓ |
|------------|-----------------------------------|----|----|--|---|

**802 590**

|            |       |    |    |  |   |
|------------|-------|----|----|--|---|
| LADA (VAZ) | Niva  | 78 | 02 |  | ✓ |
| LADA (VAZ) | Taiga | 77 | 90 |  | ✓ |

**802 601**

|      |                                   |       |    |  |   |
|------|-----------------------------------|-------|----|--|---|
| FIAT | Fiorino 1.3, 1.4, 1.6, 1.7 Diesel | 07/93 | 01 |  | ✓ |
| FIAT | Fiorino 1.7 Turbo Diesel          | 07/93 | 01 |  | ✓ |

**802 605**

|      |          |    |    |  |   |
|------|----------|----|----|--|---|
| FIAT | Seicento | 98 | 05 |  | ✓ |
|------|----------|----|----|--|---|

**802 620**

|        |      |    |    |  |   |
|--------|------|----|----|--|---|
| LANCIA | Beta | 72 | 84 |  | ✓ |
|--------|------|----|----|--|---|

**802 646**

|            |          |    |    |  |   |
|------------|----------|----|----|--|---|
| ALFA ROMEO | Spider I | 78 | 93 |  | ✓ |
|------------|----------|----|----|--|---|

**802 652**

|            |                |    |    |  |   |
|------------|----------------|----|----|--|---|
| ALFA ROMEO | Alfa 33        | 83 | 94 |  | ✓ |
| ALFA ROMEO | Alfasud        | 72 | 84 |  | ✓ |
| ALFA ROMEO | Alfasud Sprint | 77 | 90 |  | ✓ |

**802 658**

|            |        |    |    |  |   |
|------------|--------|----|----|--|---|
| LADA (VAZ) | Sagona | 90 | 97 |  | ✓ |
|------------|--------|----|----|--|---|

**802 658**

|            |        |    |    |  |   |
|------------|--------|----|----|--|---|
| LADA (VAZ) | Samara | 86 | 97 |  | ✓ |
|------------|--------|----|----|--|---|

**802 660**

|       |     |    |    |  |   |
|-------|-----|----|----|--|---|
| IVECO | 238 | 72 | 82 |  | ✓ |
|-------|-----|----|----|--|---|

**802 662**

|       |     |    |    |  |   |
|-------|-----|----|----|--|---|
| IVECO | 238 | 72 | 82 |  | ✓ |
|-------|-----|----|----|--|---|

**802 720**

|       |                             |    |    |  |   |
|-------|-----------------------------|----|----|--|---|
| SKODA | 105 S, 105 L                | 77 | 89 |  | ✓ |
| SKODA | 120, 120 L, 120 LS, 120 GLS | 77 | 89 |  | ✓ |

**802 732**

|       |                       |    |    |  |   |
|-------|-----------------------|----|----|--|---|
| SKODA | Favorit 115, 135, 136 | 88 | 92 |  | ✓ |
| SKODA | Forman                | 91 | 92 |  | ✓ |

**802 740**

|       |                                  |       |       |  |   |
|-------|----------------------------------|-------|-------|--|---|
| IVECO | Daily I 35-8                     | 10/84 | 02/96 |  | ✓ |
| IVECO | Daily I 35-10                    | 06/89 | 01/97 |  | ✓ |
| IVECO | Daily I 45-10, 49-10             | 85    | 88    |  | ✓ |
| IVECO | Daily I 49-12 Turbodayly         | 85    | 02/96 |  | ✓ |
| IVECO | Grinta Ser S Turbo: 45-10, 49-10 | 03/85 | 88    |  | ✓ |

**802 748**

|       |                                 |       |       |  |   |
|-------|---------------------------------|-------|-------|--|---|
| IVECO | Daily I 30-8                    | 10/84 | 01/97 |  | ✓ |
| IVECO | Daily I 30-9                    | 10/84 | 88    |  | ✓ |
| IVECO | Daily I 35-8                    | 10/84 | 99    |  | ✓ |
| IVECO | Daily I 35-9                    | 06/81 | 09/84 |  | ✓ |
| IVECO | Daily I 35-10                   | 06/81 | 01/97 |  | ✓ |
| IVECO | Daily I 35-10 Turbodayly        | 96    | 99    |  | ✓ |
| IVECO | Daily I 35-12 Turbodayly        | 81    | 99    |  | ✓ |
| IVECO | Daily I 40-8                    | 10/84 | 02/96 |  | ✓ |
| IVECO | Daily I 45-10                   | 85    | 88    |  | ✓ |
| IVECO | Daily I 49-10                   | 85    | 88    |  | ✓ |
| IVECO | Grinta                          | 06/81 | 09/84 |  | ✓ |
| IVECO | Grinta Ser S: 30-9, 35-8, 35-10 | 10/84 | 88    |  | ✓ |
| IVECO | Grinta Ser S: 40-8, 40-10       | 10/84 | 88    |  | ✓ |

**802 826**

|            |                                 |       |    |  |   |
|------------|---------------------------------|-------|----|--|---|
| ALFA ROMEO | GTV II 1.8 16V, 2.0 TS 16V      | 04/00 | 06 |  | ✓ |
| ALFA ROMEO | GTV II 2.0 V6 Turbo, 3.0 V6 24V | 04/00 | 06 |  | ✓ |
| ALFA ROMEO | GTV II 2.0 JTS, 3.2 V6 24V      | 04/03 | 06 |  | ✓ |
| ALFA ROMEO | Spider II 1.8 16V, 2.0 TS 16V   | 04/00 | 06 |  | ✓ |
| ALFA ROMEO | Spider II 2.0 V6 Turbo, 3.0 V6  | 04/00 | 06 |  | ✓ |
| ALFA ROMEO | Spider II 2.0 JTS, 3.2 V6 24V   | 04/03 | 06 |  | ✓ |
| ALFA ROMEO | Spider II 3.0 V6 24V            | 04/00 | 06 |  | ✓ |

**802 839**

|            |   |       |       |  |   |
|------------|---|-------|-------|--|---|
| ALFA ROMEO | Alfa 145 1.4 i.e., 1.6 i.e., 1.7 i.e., 1.8 i.e. | 10/98 | 01    |  | ✓ |
| ALFA ROMEO | Alfa 145 1.9 JTD, 2.0 16V                       | 10/98 | 01    |  | ✓ |
| ALFA ROMEO | Alfa 146 1.4 i.e., 1.6 i.e., 1.7 i.e., 1.8 i.e. | 10/98 | 01    |  | ✓ |
| ALFA ROMEO | Alfa 146 1.9 JTD, 2.0 16V                       | 10/98 | 01    |  | ✓ |
| FIAT       | Barchetta 1.8 16V                               | 05/99 | 05    |  | ✓ |
| FIAT       | Brava 1.2 16V                                   | 99    | 01    |  | ✓ |
| FIAT       | Brava 1.6 16V, 1.8 GT 16V                       | 10/98 | 01    |  | ✓ |
| FIAT       | Brava 1.9 Turbo Diesel, 1.9 JTD                 | 10/98 | 01    |  | ✓ |
| FIAT       | Bravo 1.2 16V                                   | 99    | 01    |  | ✓ |
| FIAT       | Bravo 1.6 16V, 1.8 GT 16V                       | 10/98 | 01    |  | ✓ |
| FIAT       | Bravo 1.9 Turbo Diesel, 1.9 JTD                 | 10/98 | 01    |  | ✓ |
| FIAT       | Bravo 2.0 HGT 20V                               | 10/98 | 01    |  | ✓ |
| FIAT       | Idea 1.2 16V, 1.3 JTD, 1.4, 1.9 JTD             | 01/04 | 05    |  | ✓ |
| FIAT       | Idea 1.3 D Multijet                             | 10/05 | 12/05 |  | ✓ |
| FIAT       | Marea 1.2 12V, 2.4 JTD                          | 99    | 05    |  | ✓ |
| FIAT       | Marea 1.4 12V, 1.6 16V, 1.8 16V                 | 98    | 05    |  | ✓ |
| FIAT       | Marea 1.9 Turbo Diesel, 1.9 JTD                 | 98    | 05    |  | ✓ |
| FIAT       | Marea 2.0 20V, 2.0 20V Turbo                    | 98    | 05    |  | ✓ |
| FIAT       | Marea 2.4 Turbo Diesel                          | 98    | 99    |  | ✓ |
| FIAT       | Marea 2.4 JTD                                   | 99    | 05    |  | ✓ |
| FIAT       | Multipla  | 99    | 05    |  | ✓ |

**802 839**

|        |                                 |       |    |   |  |
|--------|---------------------------------|-------|----|---|--|
| FIAT   | Palio, Palio Weekend            | 09/01 | 05 | ✓ |  |
| FIAT   | Panda II 1.1, 1.2, 1.3 JTD      | 03    | 06 | ✓ |  |
| FIAT   | Punto II 1.2 8V, 1.2 16V        | 09/99 | 06 | ✓ |  |
| FIAT   | Punto II 1.3 JTD, 1.4 16V       | 03    | 06 | ✓ |  |
| FIAT   | Punto II 1.8 16V HGT, 1.9 DS.   | 09/99 | 06 | ✓ |  |
| FIAT   | Punto II 1.9 JTD                | 01    | 06 | ✓ |  |
| FIAT   | Stilo 1.2 16V                   | 02    | 05 | ✓ |  |
| FIAT   | Stilo 1.4 16V                   | 04    | 05 | ✓ |  |
| FIAT   | Stilo 1.6 16V, 1.8 16V, 1.9 JTD | 01    | 05 | ✓ |  |
| FIAT   | Stilo 2.4 20V                   | 01    | 05 | ✓ |  |
| LANCIA | Lybra 1.6 16V, 1.8 16V          | 99    | 05 | ✓ |  |
| LANCIA | Lybra 1.9 JTD, 2.0 20V          | 99    | 05 | ✓ |  |
| LANCIA | Lybra 2.4 JTD                   | 99    | 05 | ✓ |  |
| LANCIA | Musa 1.3 Multijet, 1.6 16V      | 04    | 05 | ✓ |  |
| LANCIA | Musa 1.9 Multijet               | 04    | 05 | ✓ |  |
| LANCIA | Y                               | 98    | 04 | ✓ |  |
| LANCIA | Ypsilon 1.2 8V, 1.2 16V         | 10/03 | 04 | ✓ |  |
| LANCIA | Ypsilon 1.3 JTD, 1.4 16V        | 10/03 | 04 | ✓ |  |

**802 870**

|            |                              |    |       |   |  |
|------------|------------------------------|----|-------|---|--|
| ALFA ROMEO | Alfa 147 1.6 TS 16V, 1.9 JTD | 01 | 09/04 | ✓ |  |
| ALFA ROMEO | Alfa 147 2.0 TS 16V          | 01 | 09/04 | ✓ |  |
| ALFA ROMEO | Alfa 147 3.2 GTA             | 03 | 09/04 | ✓ |  |
| ALFA ROMEO | Alfa 156                     | 97 | 09/04 | ✓ |  |
| ALFA ROMEO | GT 1.8 TS, 1.9 JTD           | 03 | 09/04 | ✓ |  |
| ALFA ROMEO | GT 2.0 JTS, GT 3.2 GTA       | 03 | 09/04 | ✓ |  |

**802 886**

|        |                                 |       |       |   |  |
|--------|---------------------------------|-------|-------|---|--|
| LANCIA | Kappa 2.0 16V, 2.0 20V, 2.4 20V | 04/98 | 10/01 | ✓ |  |
| LANCIA | Kappa 2.4 JTD, 3.0 V6 24V       | 04/98 | 10/01 | ✓ |  |
| LANCIA | Kappa Coupé 2.0 16V, 2.0 20V    | 04/98 | 10/01 | ✓ |  |
| LANCIA | Kappa Coupé 2.4 20V, 3.0 V6 24V | 04/98 | 10/01 | ✓ |  |

**802 888**

|            |          |    |    |   |  |
|------------|----------|----|----|---|--|
| ALFA ROMEO | Alfa 166 | 98 | 06 | ✓ |  |
|------------|----------|----|----|---|--|

**802 954**

|      |                      |    |    |   |  |
|------|----------------------|----|----|---|--|
| FIAT | X 1/9 Five speed 1.5 | 79 | 89 | ✓ |  |
|------|----------------------|----|----|---|--|

**802 980**

|      |                              |       |    |   |  |
|------|------------------------------|-------|----|---|--|
| FIAT | Doblò 1.2 8V, 1.6 16V, 1.9 D | 03/01 | 05 | ✓ |  |
| FIAT | Doblò 1.3 JTD                | 05/04 | 05 | ✓ |  |
| FIAT | Doblò 1.9 JTD                | 10/01 | 05 | ✓ |  |

**880 419**

|            |                                     |    |       |   |   |
|------------|-------------------------------------|----|-------|---|---|
| LAND-ROVER | Defender                            | 95 | 99    | ✓ | ✓ |
| LAND-ROVER | Discovery                           | 92 | 98    | ✓ | ✓ |
| LAND-ROVER | Land-Rover 90 Defender R.H.D, L.H.D | 88 | 98    | ✓ | ✓ |
| LAND-ROVER | Land-Rover 110 R.H.D, L.H.D         | 85 | 86    | ✓ | ✓ |
| LAND-ROVER | Land-Rover 110 Defender             | 87 | 98    | ✓ | ✓ |
| LAND-ROVER | Land-Rover 130 Defender             | 91 | 95    | ✓ | ✓ |
| LAND-ROVER | Range Rover                         | 90 | 02/02 | ✓ | ✓ |

**880 421**

|            |             |       |    |   |   |
|------------|-------------|-------|----|---|---|
| LAND-ROVER | Discovery   | 89    | 92 | ✓ | ✓ |
| LAND-ROVER | Range Rover | 07/85 | 92 | ✓ | ✓ |

**880 493**

|        |              |    |    |   |   |
|--------|--------------|----|----|---|---|
| JAGUAR | XJ-S 3.6     | 88 | 91 | ✓ |   |
| JAGUAR | XJ-S 4.0 24V | 91 | 96 | ✓ |   |
| JAGUAR | XJ-S 5.3     | 88 | 92 | ✓ |   |
| JAGUAR | XJR-S 6.0    | 92 | 96 | ✓ | ✓ |

**880 525**

|             |                  |    |    |   |  |
|-------------|------------------|----|----|---|--|
| ROVER GROUP | Allegro          | 73 | 82 | ✓ |  |
| ROVER GROUP | Ital             | 81 | 84 | ✓ |  |
| ROVER GROUP | Vanden Plas 1500 | 75 | 81 | ✓ |  |
| TRIUMPH     | TR 7             | 75 | 82 | ✓ |  |

**880 812**

|            |                                     |       |       |   |   |
|------------|-------------------------------------|-------|-------|---|---|
| LAND-ROVER | Land-Rover Ser. III                 | 10/80 | 85    | ✓ | ✓ |
| LAND-ROVER | Land-Rover 90                       | 84    | 87    | ✓ | ✓ |
| LAND-ROVER | Land-Rover 90 Defender R.H.D, L.H.D | 88    | 88    | ✓ | ✓ |
| LAND-ROVER | Land-Rover 109 V8                   | 79    | 84    | ✓ | ✓ |
| LAND-ROVER | Land-Rover 110 R.H.D, L.H.D         | 84    | 85    | ✓ | ✓ |
| LAND-ROVER | Range Rover                         | 70    | 06/85 | ✓ | ✓ |

**880 912**

|            |            |       |    |   |   |
|------------|------------|-------|----|---|---|
| LAND-ROVER | Freelander | 02/01 | 05 | ✓ | ✓ |
|------------|------------|-------|----|---|---|

**881 237**

|             |          |    |    |   |  |
|-------------|----------|----|----|---|--|
| ROVER GROUP | Rover 75 | 99 | 04 | ✓ |  |
|-------------|----------|----|----|---|--|

**881 489**

|        |              |    |    |   |  |
|--------|--------------|----|----|---|--|
| JAGUAR | XJ 6 2.9     | 87 | 90 | ✓ |  |
| JAGUAR | XJ 6 3.2 24V | 91 | 96 | ✓ |  |
| JAGUAR | XJ 6 3.6     | 87 | 89 | ✓ |  |
| JAGUAR | XJ 6 4.0 24V | 90 | 96 | ✓ |  |
| JAGUAR | XJ 12 5.3    | 87 | 92 | ✓ |  |
| JAGUAR | XJ 12 6.0    | 93 | 96 | ✓ |  |

**881 507**

|             |                      |       |       |   |  |
|-------------|----------------------|-------|-------|---|--|
| ROVER GROUP | Allegro              | 73    | 82    | ✓ |  |
| ROVER GROUP | Metro 1.0, 1.3       | 81    | 03/90 | ✓ |  |
| ROVER GROUP | Mini Ser.            | 60    | 80    | ✓ |  |
| ROVER GROUP | Mini, Mini Automatic | 10/80 | 84    | ✓ |  |
| ROVER GROUP | Mini Van 1/4 ton     | 60    | 84    | ✓ |  |
| ROVER GROUP | Vanden Plas 1500     | 75    | 81    | ✓ |  |

**881 529**

|             |                              |    |    |   |  |
|-------------|------------------------------|----|----|---|--|
| ROVER GROUP | Rover 2300, 2600, 3500 (SD1) | 76 | 86 | ✓ |  |
|-------------|------------------------------|----|----|---|--|

**881 534**

|             |                                      |    |       |   |  |
|-------------|--------------------------------------|----|-------|---|--|
| ROVER GROUP | Maestro 1.3, 1.6, Van 1.3            | 86 | 10/88 | ✓ |  |
| ROVER GROUP | Montego 1.3, 1.6, 2.0, 2.0 Automatic | 86 | 10/88 | ✓ |  |
| ROVER GROUP | Montego MG Turbo                     | 86 | 10/88 | ✓ |  |

**881 564**

|         |                    |    |    |   |  |
|---------|--------------------|----|----|---|--|
| DAIMLER | Daimler 4.2        | 84 | 86 | ✓ |  |
| DAIMLER | Double Six 5.3     | 77 | 86 | ✓ |  |
| DAIMLER | Limousine DS420    | 77 | 84 | ✓ |  |
| DAIMLER | Limousine 4.2      | 85 | 90 | ✓ |  |
| DAIMLER | Sovereign 4.2      | 77 | 83 | ✓ |  |
| JAGUAR  | XJ 6 3.4, 4.2, 5.3 | 77 | 86 | ✓ |  |
| JAGUAR  | XJ-S 3.6           | 84 | 88 | ✓ |  |
| JAGUAR  | XJ-S 5.3           | 77 | 88 | ✓ |  |

**881 592**

|             |                       |    |    |   |  |
|-------------|-----------------------|----|----|---|--|
| ROVER GROUP | Mini 1275 GT          | 69 | 80 | ✓ |  |
| ROVER GROUP | Mini                  | 84 | 95 | ✓ |  |
| ROVER GROUP | Mini Automatic        | 84 | 95 | ✓ |  |
| ROVER GROUP | Mini 25 (Anniversary) | 84 | 85 | ✓ |  |
| ROVER GROUP | Mini Turbo            | 84 | 94 | ✓ |  |
| ROVER GROUP | Mini Van 1/4 ton      | 85 | 85 | ✓ |  |

**881 594**

|             |                                 |       |       |   |   |
|-------------|---------------------------------|-------|-------|---|---|
| ROVER GROUP | Maestro 1.3, 1.6                | 11/88 | 94    | ✓ |   |
| ROVER GROUP | Maestro 2.0 Diesel              | 89    | 94    | ✓ |   |
| ROVER GROUP | Maestro Van 1.3                 | 11/88 | 94    | ✓ |   |
| ROVER GROUP | Maestro Van 2.0 Diesel          | 89    | 94    | ✓ |   |
| ROVER GROUP | Metro 1.1, 1.4                  | 04/90 | 94    | ✓ |   |
| ROVER GROUP | Metro 1.4 Diesel                | 93    | 94    | ✓ |   |
| ROVER GROUP | M.G.F                           | 95    | 03/96 | ✓ | ✓ |
| ROVER GROUP | Montego 1.6, 2.0, 2.0 Automatic | 11/88 | 94    | ✓ |   |
| ROVER GROUP | Montego 2.0 Turbo Diesel        | 89    | 94    | ✓ |   |
| ROVER GROUP | Montego MG Turbo                | 11/88 | 94    | ✓ |   |
| ROVER GROUP | Rover 100                       | 91    | 98    | ✓ |   |

**881 609**

|       |                      |       |    |   |  |
|-------|----------------------|-------|----|---|--|
| HONDA | Legend 2.5i 24V (HS) | 11/86 | 90 | ✓ |  |
|-------|----------------------|-------|----|---|--|

**881 609**

|             |           |      |    |    |   |  |
|-------------|-----------|------|----|----|---|--|
| ROVER GROUP | Rover 800 | (XS) | 86 | 91 | ✓ |  |
| ROVER GROUP | Rover 800 | (RS) | 92 | 99 | ✓ |  |

**881 622**

|             |                       |  |    |    |   |  |
|-------------|-----------------------|--|----|----|---|--|
| ROVER GROUP | Maestro 1.3, 1.6      |  | 83 | 86 | ✓ |  |
| ROVER GROUP | Maestro Van 1.3       |  | 84 | 86 | ✓ |  |
| ROVER GROUP | Montego 1.3, 1.6, 2.0 |  | 84 | 86 | ✓ |  |
| ROVER GROUP | Montego 2.0 Automatic |  | 86 | 86 | ✓ |  |
| ROVER GROUP | Montego MG Turbo      |  | 86 | 86 | ✓ |  |

**881 704**

|             |                             |       |       |       |   |  |
|-------------|-----------------------------|-------|-------|-------|---|--|
| HONDA       | Accord 1.6                  | (CA4) | 86    | 89    | ✓ |  |
| HONDA       | Accord 2.0                  | (CA5) | 86    | 89    | ✓ |  |
| HONDA       | Accord Aerodeck 2.0         | (CA5) | 86    | 92    | ✓ |  |
| HONDA       | Concerto 1.5i 16V, 1.6i 16V | (HW)  | 89    | 95    | ✓ |  |
| HONDA       | Prelude 1.8 EX              | (AB)  | 86    | 04/87 | ✓ |  |
| ROVER GROUP | Cabiolet                    | (XW)  | 92    | 99    | ✓ |  |
| ROVER GROUP | Coupé                       |       | 92    | 99    | ✓ |  |
| ROVER GROUP | Rover 200                   | (XW)  | 90    | 00    | ✓ |  |
| ROVER GROUP | Rover 200                   | (RF)  | 11/95 | 02    | ✓ |  |
| ROVER GROUP | Rover 25                    | (RF)  | 11/99 | 04    | ✓ |  |
| ROVER GROUP | Rover 400                   | (XW)  | 90    | 00    | ✓ |  |

**881 725**

|             |           |      |       |    |   |  |
|-------------|-----------|------|-------|----|---|--|
| ROVER GROUP | Rover 400 | (RT) | 04/96 | 00 | ✓ |  |
| ROVER GROUP | Rover 45  | (RT) | 01/00 | 04 | ✓ |  |

**882 167**

|             |               |      |       |    |   |  |
|-------------|---------------|------|-------|----|---|--|
| ROVER GROUP | Rover 400 1.6 | (RT) | 98    | 00 | ✓ |  |
| ROVER GROUP | Rover 45      | (RT) | 01/00 | 04 | ✓ |  |

**882 235**

|             |          |  |    |    |   |  |
|-------------|----------|--|----|----|---|--|
| ROVER GROUP | Rover 75 |  | 99 | 04 | ✓ |  |
|-------------|----------|--|----|----|---|--|

**882 463**

|             |                  |  |       |    |   |  |
|-------------|------------------|--|-------|----|---|--|
| ROVER GROUP | Metro 1.1, 1.4   |  | 04/90 | 94 | ✓ |  |
| ROVER GROUP | Metro 1.4 Diesel |  | 93    | 94 | ✓ |  |
| ROVER GROUP | Rover 100        |  | 91    | 98 | ✓ |  |

**882 483**

|             |                                |      |       |    |   |  |
|-------------|--------------------------------|------|-------|----|---|--|
| ROVER GROUP | Coupé                          |      | 92    | 99 | ✓ |  |
| ROVER GROUP | Rover 200                      | (XW) | 03/96 | 00 | ✓ |  |
| ROVER GROUP | Rover 200                      | (RF) | 11/95 | 02 | ✓ |  |
| ROVER GROUP | Rover 25                       | (RF) | 11/99 | 04 | ✓ |  |
| ROVER GROUP | Rover 400                      | (XW) | 03/96 | 00 | ✓ |  |
| ROVER GROUP | Rover 400 1.4, 2.0, 2.0 Diesel | (RT) | 04/96 | 00 | ✓ |  |
| ROVER GROUP | Rover 45                       | (RT) | 01/00 | 04 | ✓ |  |

**882 487**

|             |           |      |       |    |   |  |
|-------------|-----------|------|-------|----|---|--|
| ROVER GROUP | Coupé     |      | 92    | 99 | ✓ |  |
| ROVER GROUP | Rover 200 | (XW) | 90    | 99 | ✓ |  |
| ROVER GROUP | Rover 200 | (RF) | 11/95 | 02 | ✓ |  |
| ROVER GROUP | Rover 25  | (RF) | 11/99 | 04 | ✓ |  |
| ROVER GROUP | Rover 400 | (XW) | 90    | 00 | ✓ |  |
| ROVER GROUP | Rover 400 | (RT) | 04/96 | 00 | ✓ |  |
| ROVER GROUP | Rover 45  | (RT) | 01/00 | 04 | ✓ |  |

**882 491**

|        |              |  |    |    |   |  |
|--------|--------------|--|----|----|---|--|
| JAGUAR | XJ 6 2.9     |  | 87 | 90 | ✓ |  |
| JAGUAR | XJ 6 3.2 24V |  | 91 | 96 | ✓ |  |
| JAGUAR | XJ 6 3.6     |  | 87 | 89 | ✓ |  |
| JAGUAR | XJ 6 4.0 24V |  | 90 | 96 | ✓ |  |
| JAGUAR | XJ 12 5.3    |  | 87 | 92 | ✓ |  |
| JAGUAR | XJ 12 6.0    |  | 93 | 96 | ✓ |  |

**882 531**

|             |                        |       |    |    |   |  |
|-------------|------------------------|-------|----|----|---|--|
| ROVER GROUP | Rover 2300, 2600, 3500 | (SD1) | 76 | 86 | ✓ |  |
| TRIUMPH     | TR 7                   |       | 75 | 82 | ✓ |  |

**882 596**

|             |                       |  |    |    |   |  |
|-------------|-----------------------|--|----|----|---|--|
| ROVER GROUP | Mini 1275 GT          |  | 69 | 80 | ✓ |  |
| ROVER GROUP | Mini, Mini Automatic  |  | 84 | 85 | ✓ |  |
| ROVER GROUP | Mini 25 (Anniversary) |  | 84 | 85 | ✓ |  |

**882 598**

|             |                      |  |       |       |   |  |
|-------------|----------------------|--|-------|-------|---|--|
| ROVER GROUP | Metro 1.0, 1.3       |  | 81    | 03/90 | ✓ |  |
| ROVER GROUP | Mini Ser.            |  | 60    | 80    | ✓ |  |
| ROVER GROUP | Mini, Mini Automatic |  | 10/80 | 95    | ✓ |  |
| ROVER GROUP | Mini Turbo           |  | 84    | 94    | ✓ |  |
| ROVER GROUP | Mini Van 1/4 ton     |  | 60    | 85    | ✓ |  |

**882 607**

|             |                                 |      |    |    |   |  |
|-------------|---------------------------------|------|----|----|---|--|
| ROVER GROUP | Rover 600 2.0 Turbo, 2.0 Diesel | (RH) | 93 | 00 | ✓ |  |
|-------------|---------------------------------|------|----|----|---|--|

**882 611**

|             |           |      |    |    |   |  |
|-------------|-----------|------|----|----|---|--|
| ROVER GROUP | Rover 800 | (XS) | 86 | 91 | ✓ |  |
| ROVER GROUP | Rover 800 | (RS) | 92 | 99 | ✓ |  |

**882 613**

|             |           |      |    |    |   |  |
|-------------|-----------|------|----|----|---|--|
| ROVER GROUP | Rover 800 | (XS) | 86 | 91 | ✓ |  |
| ROVER GROUP | Rover 800 | (RS) | 92 | 99 | ✓ |  |

**882 624**

|             |                        |      |    |       |   |  |
|-------------|------------------------|------|----|-------|---|--|
| ROVER GROUP | Rover 200 1.6, 400 1.6 | (XW) | 90 | 02/96 | ✓ |  |
|-------------|------------------------|------|----|-------|---|--|

**882 626**

|             |                                 |      |    |       |   |  |
|-------------|---------------------------------|------|----|-------|---|--|
| ROVER GROUP | Rover 200 1.4, 1.8 Turbo Diesel | (XW) | 90 | 02/96 | ✓ |  |
| ROVER GROUP | Rover 200 2.0                   | (XW) | 90 | 02/96 | ✓ |  |
| ROVER GROUP | Rover 400 1.4, 1.8 Turbo Diesel | (XW) | 90 | 02/96 | ✓ |  |
| ROVER GROUP | Rover 400 1.9 Diesel, 2.0       | (XW) | 90 | 02/96 | ✓ |  |

**882 643**

|             |                        |  |    |    |   |  |
|-------------|------------------------|--|----|----|---|--|
| ROVER GROUP | Maestro Van 1.3        |  | 84 | 94 | ✓ |  |
| ROVER GROUP | Maestro Van 2.0 Diesel |  | 89 | 94 | ✓ |  |

**882 664**

|             |                                 |  |    |       |   |  |
|-------------|---------------------------------|--|----|-------|---|--|
| ROVER GROUP | Maestro 1.3, 1.6                |  | 83 | 94    | ✓ |  |
| ROVER GROUP | Maestro 2.0 Diesel              |  | 89 | 94    | ✓ |  |
| ROVER GROUP | Montego 1.3                     |  | 84 | 10/88 | ✓ |  |
| ROVER GROUP | Montego 1.6, 2.0                |  | 84 | 94    | ✓ |  |
| ROVER GROUP | Montego 2.0 Automatic, MG Turbo |  | 86 | 94    | ✓ |  |
| ROVER GROUP | Montego 2.0 Turbo Diesel        |  | 89 | 94    | ✓ |  |

**882 666**

|         |                          |  |    |    |   |  |
|---------|--------------------------|--|----|----|---|--|
| DAIMLER | Daimler 4.2              |  | 84 | 86 | ✓ |  |
| DAIMLER | Double Six 5.3           |  | 77 | 86 | ✓ |  |
| DAIMLER | Limousine DS420          |  | 77 | 84 | ✓ |  |
| DAIMLER | Limousine 4.2            |  | 85 | 90 | ✓ |  |
| DAIMLER | Sovereign 4.2            |  | 77 | 83 | ✓ |  |
| JAGUAR  | XJ 6 3.4, 4.2, XJ 12 5.3 |  | 77 | 86 | ✓ |  |
| JAGUAR  | XJ-S 3.6                 |  | 84 | 91 | ✓ |  |
| JAGUAR  | XJ-S 4.0 24V             |  | 91 | 92 | ✓ |  |
| JAGUAR  | XJ-S 5.3                 |  | 77 | 92 | ✓ |  |

**882 727**

|             |                         |      |    |    |   |  |
|-------------|-------------------------|------|----|----|---|--|
| ROVER GROUP | Rover 600 1.8, 2.0, 2.3 | (RH) | 93 | 00 | ✓ |  |
|-------------|-------------------------|------|----|----|---|--|

**882 729**

|             |                                 |      |    |    |   |  |
|-------------|---------------------------------|------|----|----|---|--|
| ROVER GROUP | Rover 600 1.8, 2.0, 2.3         | (RH) | 93 | 00 | ✓ |  |
| ROVER GROUP | Rover 600 2.0 Turbo, 2.0 Diesel | (RH) | 93 | 00 | ✓ |  |

**882 896**

|             |           |      |       |    |   |  |
|-------------|-----------|------|-------|----|---|--|
| ROVER GROUP | Rover 200 | (RF) | 11/95 | 02 | ✓ |  |
| ROVER GROUP | Rover 25  | (RF) | 11/99 | 04 | ✓ |  |
| ROVER GROUP | Rover 400 | (RT) | 98    | 00 | ✓ |  |
| ROVER GROUP | Rover 45  | (RT) | 01/00 | 04 | ✓ |  |

**891 333**

|       |            |  |       |    |   |  |
|-------|------------|--|-------|----|---|--|
| VOLVO | 960        |  | 08/94 | 97 | ✓ |  |
| VOLVO | S 90, V 90 |  | 97    | 98 | ✓ |  |



**891 466**



|       |                          |       |       |   |  |
|-------|--------------------------|-------|-------|---|--|
| VOLVO | 740                      | 07/88 | 92    | ✓ |  |
| VOLVO | 740 2.0 DACT 16V Turbo   | 90    | 92    | ✓ |  |
| VOLVO | 760                      | 07/88 | 90    | ✓ |  |
| VOLVO | 780                      | 08/88 | 90    | ✓ |  |
| VOLVO | 940 2.0 Turbo, 2.3 Turbo | 90    | 98    | ✓ |  |
| VOLVO | 940 2.0, 2.3, 2.4 Diesel | 90    | 98    | ✓ |  |
| VOLVO | 960                      | 91    | 07/94 | ✓ |  |

**891 469**



|       |                            |    |       |   |  |
|-------|----------------------------|----|-------|---|--|
| VOLVO | C 70, S 70, V 70, V 70 AWD | 97 | 06/98 | ✓ |  |
|-------|----------------------------|----|-------|---|--|

**891 477**



|       |      |       |       |   |  |
|-------|------|-------|-------|---|--|
| VOLVO | S 40 | 07/97 | 12/03 | ✓ |  |
| VOLVO | V 40 | 07/97 | 04    | ✓ |  |

**891 482**



|       |                          |       |       |   |  |
|-------|--------------------------|-------|-------|---|--|
| VOLVO | 740                      | 07/87 | 92    | ✓ |  |
| VOLVO | 760                      | 07/87 | 90    | ✓ |  |
| VOLVO | 940 2.0, 2.3, 2.4 Diesel | 90    | 98    | ✓ |  |
| VOLVO | 960                      | 91    | 07/94 | ✓ |  |

**891 484**



|       |     |    |       |   |  |
|-------|-----|----|-------|---|--|
| VOLVO | 440 | 88 | 06/91 | ✓ |  |
| VOLVO | 460 | 90 | 06/91 | ✓ |  |
| VOLVO | 480 | 86 | 06/91 | ✓ |  |

**891 486**



|       |          |       |    |   |  |
|-------|----------|-------|----|---|--|
| VOLVO | 440, 460 | 07/91 | 96 | ✓ |  |
| VOLVO | 480      | 07/91 | 95 | ✓ |  |

**891 496**



|      |      |    |    |   |  |
|------|------|----|----|---|--|
| SAAB | 9000 | 90 | 98 | ✓ |  |
|------|------|----|----|---|--|

**891 520**



|       |     |    |       |   |  |
|-------|-----|----|-------|---|--|
| VOLVO | 740 | 83 | 06/87 | ✓ |  |
| VOLVO | 760 | 81 | 06/87 | ✓ |  |
| VOLVO | 780 | 85 | 07/87 | ✓ |  |

**891 522**



|       |     |    |    |   |  |
|-------|-----|----|----|---|--|
| VOLVO | 240 | 81 | 93 | ✓ |  |
| VOLVO | 260 | 81 | 85 | ✓ |  |

**891 524**



|      |     |    |    |   |  |
|------|-----|----|----|---|--|
| SAAB | 90  | 85 | 87 | ✓ |  |
| SAAB | 900 | 86 | 93 | ✓ |  |

**891 536**



|       |          |       |       |   |  |
|-------|----------|-------|-------|---|--|
| VOLVO | 740, 760 | 07/87 | 06/88 | ✓ |  |
| VOLVO | 780      | 08/87 | 07/88 | ✓ |  |

**891 544**



|       |     |    |       |   |  |
|-------|-----|----|-------|---|--|
| VOLVO | 850 | 91 | 06/93 | ✓ |  |
|-------|-----|----|-------|---|--|

**891 546**



|      |      |    |    |   |  |
|------|------|----|----|---|--|
| SAAB | 9000 | 85 | 89 | ✓ |  |
|------|------|----|----|---|--|

**891 591**



|       |               |       |       |   |  |
|-------|---------------|-------|-------|---|--|
| VOLVO | XC 90, 90 AWD | 10/02 | 04/06 | ✓ |  |
|-------|---------------|-------|-------|---|--|

**891 628**



|       |         |       |    |   |  |
|-------|---------|-------|----|---|--|
| VOLVO | 850     | 07/93 | 97 | ✓ |  |
| VOLVO | 850 AWD | 96    | 97 | ✓ |  |

**891 630**



|      |          |    |    |   |  |
|------|----------|----|----|---|--|
| SAAB | 900      | 94 | 98 | ✓ |  |
| SAAB | 9-3, 9-5 | 98 | 99 | ✓ |  |

**891 706**



|      |     |    |    |   |  |
|------|-----|----|----|---|--|
| SAAB | 90  | 85 | 85 | ✓ |  |
| SAAB | 99  | 82 | 84 | ✓ |  |
| SAAB | 900 | 81 | 85 | ✓ |  |

**891 731**



|       |            |    |       |   |  |
|-------|------------|----|-------|---|--|
| VOLVO | S 40, V 40 | 95 | 06/97 | ✓ |  |
|-------|------------|----|-------|---|--|

**891 822**



|       |          |    |    |   |  |
|-------|----------|----|----|---|--|
| VOLVO | 66       | 75 | 80 | ✓ |  |
| VOLVO | 340      | 83 | 92 | ✓ |  |
| VOLVO | 343, 345 | 80 | 82 | ✓ |  |
| VOLVO | 360      | 83 | 92 | ✓ |  |

**891 869**



|       |                |       |       |   |  |
|-------|----------------|-------|-------|---|--|
| VOLVO | C 70           | 07/98 | 04    | ✓ |  |
| VOLVO | S 70           | 07/98 | 00    | ✓ |  |
| VOLVO | V 70, V 70 AWD | 07/98 | 03/00 | ✓ |  |

**891 878**



|       |                 |       |    |   |  |
|-------|-----------------|-------|----|---|--|
| VOLVO | S 60, XC 70 AWD | 00    | 04 | ✓ |  |
| VOLVO | S 60 AWD        | 01    | 04 | ✓ |  |
| VOLVO | V 70, V 70 AWD  | 04/00 | 04 | ✓ |  |
| VOLVO | S 80            | 98    | 04 | ✓ |  |
| VOLVO | S 80 AWD        | 03    | 04 | ✓ |  |

**891 887**



|      |     |    |       |   |  |
|------|-----|----|-------|---|--|
| SAAB | 9-3 | 99 | 09/02 | ✓ |  |
| SAAB | 9-5 | 99 | 04    | ✓ |  |

**892 458**



|       |                          |    |       |   |  |
|-------|--------------------------|----|-------|---|--|
| VOLVO | 740                      | 83 | 92    | ✓ |  |
| VOLVO | 760                      | 81 | 90    | ✓ |  |
| VOLVO | 780                      | 85 | 07/89 | ✓ |  |
| VOLVO | 940 2.0, 2.3, 2.4 Diesel | 90 | 98    | ✓ |  |
| VOLVO | 960                      | 91 | 07/94 | ✓ |  |

**892 460**



|       |     |       |       |   |  |
|-------|-----|-------|-------|---|--|
| VOLVO | 240 | 81    | 93    | ✓ |  |
| VOLVO | 260 | 81    | 85    | ✓ |  |
| VOLVO | 740 | 07/85 | 06/88 | ✓ |  |
| VOLVO | 760 | 07/85 | 06/87 | ✓ |  |

**892 468**



|       |                          |       |       |   |  |
|-------|--------------------------|-------|-------|---|--|
| VOLVO | 740 2.0 DACT 16V Turbo   | 90    | 92    | ✓ |  |
| VOLVO | 760                      | 07/87 | 90    | ✓ |  |
| VOLVO | 780                      | 08/89 | 90    | ✓ |  |
| VOLVO | 850 AWD                  | 96    | 97    | ✓ |  |
| VOLVO | 940 2.0 Turbo, 2.3 Turbo | 90    | 98    | ✓ |  |
| VOLVO | 940 2.0, 2.3, 2.4 Diesel | 90    | 98    | ✓ |  |
| VOLVO | 960                      | 91    | 97    | ✓ |  |
| VOLVO | V 70 AWD                 | 97    | 03/00 | ✓ |  |
| VOLVO | S 90, V 90               | 97    | 98    | ✓ |  |

**892 470**



|       |     |    |    |   |  |
|-------|-----|----|----|---|--|
| VOLVO | 440 | 88 | 96 | ✓ |  |
| VOLVO | 460 | 90 | 96 | ✓ |  |
| VOLVO | 480 | 86 | 95 | ✓ |  |

**892 472**

|       |     |    |    |   |  |
|-------|-----|----|----|---|--|
| VOLVO | 440 | 89 | 96 | ✓ |  |
| VOLVO | 460 | 90 | 96 | ✓ |  |
| VOLVO | 480 | 89 | 95 | ✓ |  |

**892 474**

|       |     |    |    |   |  |
|-------|-----|----|----|---|--|
| VOLVO | 340 | 86 | 92 | ✓ |  |
| VOLVO | 360 | 86 | 92 | ✓ |  |

**892 476**

|      |      |    |    |   |  |
|------|------|----|----|---|--|
| SAAB | 900  | 88 | 93 | ✓ |  |
| SAAB | 9000 | 85 | 92 | ✓ |  |

**892 498**

|      |      |    |    |   |  |
|------|------|----|----|---|--|
| SAAB | 900  | 90 | 93 | ✓ |  |
| SAAB | 9000 | 90 | 98 | ✓ |  |

**892 587**

|       |           |       |       |   |
|-------|-----------|-------|-------|---|
| VOLVO | XC 90 AWD | 10/02 | 04/06 | ✓ |
|-------|-----------|-------|-------|---|

**892 589**

|       |       |       |       |   |
|-------|-------|-------|-------|---|
| VOLVO | XC 90 | 10/02 | 04/06 | ✓ |
|-------|-------|-------|-------|---|

**892 668**

|      |      |    |    |   |
|------|------|----|----|---|
| SAAB | 900  | 88 | 89 | ✓ |
| SAAB | 9000 | 86 | 89 | ✓ |

**892 670**

|      |     |    |    |   |
|------|-----|----|----|---|
| SAAB | 90  | 85 | 87 | ✓ |
| SAAB | 900 | 85 | 87 | ✓ |

**892 733**

|       |     |    |       |   |
|-------|-----|----|-------|---|
| VOLVO | 850 | 91 | 06/93 | ✓ |
|-------|-----|----|-------|---|

**892 735**

|       |      |       |       |   |
|-------|------|-------|-------|---|
| VOLVO | 850  | 07/93 | 97    | ✓ |
| VOLVO | C 70 | 97    | 04    | ✓ |
| VOLVO | S 70 | 97    | 00    | ✓ |
| VOLVO | V 70 | 97    | 03/00 | ✓ |

**892 806**

|      |     |    |    |   |
|------|-----|----|----|---|
| SAAB | 90  | 85 | 85 | ✓ |
| SAAB | 99  | 82 | 84 | ✓ |
| SAAB | 900 | 82 | 85 | ✓ |

**892 830**

|      |     |    |    |   |
|------|-----|----|----|---|
| SAAB | 99  | 79 | 82 | ✓ |
| SAAB | 900 | 79 | 82 | ✓ |

**892 843**

|       |      |    |       |   |
|-------|------|----|-------|---|
| VOLVO | S 40 | 95 | 12/03 | ✓ |
| VOLVO | V 40 | 95 | 04    | ✓ |

**892 872**

|       |      |       |    |   |
|-------|------|-------|----|---|
| VOLVO | S 60 | 00    | 04 | ✓ |
| VOLVO | V 70 | 04/00 | 04 | ✓ |
| VOLVO | S 80 | 98    | 04 | ✓ |

**892 929**

|       |           |       |    |   |
|-------|-----------|-------|----|---|
| VOLVO | S 60 AWD  | 01    | 04 | ✓ |
| VOLVO | V 70 AWD  | 04/00 | 04 | ✓ |
| VOLVO | XC 70 AWD | 00    | 04 | ✓ |
| VOLVO | S 80 AWD  | 03    | 04 | ✓ |

**901 231**

|          |                     |        |    |    |   |
|----------|---------------------|--------|----|----|---|
| DAIHATSU | Cuore 1000          | (L701) | 98 | 02 | ✓ |
| DAIHATSU | Cuore 1000 12V      | (L251) | 03 | 04 | ✓ |
| DAIHATSU | Sirion 1.0i 12V     | (M100) | 98 | 04 | ✓ |
| DAIHATSU | Sirion 1.3i 16V     | (M101) | 00 | 04 | ✓ |
| DAIHATSU | Sirion 4WD 1.0i 12V | (M110) | 99 | 04 | ✓ |
| DAIHATSU | Sirion 4WD 1.3i 16V | (M111) | 00 | 04 | ✓ |

**901 425**

|          |                                |                |       |    |   |
|----------|--------------------------------|----------------|-------|----|---|
| DAIHATSU | Applause I 1.6i 16V            | (A101)         | 06/89 | 97 | ✓ |
| DAIHATSU | Applause I 1.6i 16V 4WD        | (A111)         | 06/89 | 97 | ✓ |
| DAIHATSU | Applause II 1.6i 16V           |                | 07/97 | 02 | ✓ |
| DAIHATSU | Charade 1.0                    | (G100/101/112) | 89    | 93 | ✓ |
| DAIHATSU | Charade 1.0                    | (G200/201/202) | 93    | 96 | ✓ |
| DAIHATSU | Charade 1.3i 16V, 1.3i 16V 4WD | (G102)         | 89    | 92 | ✓ |
| DAIHATSU | Charade 1.3i 16V               | (G200/201/202) | 93    | 98 | ✓ |
| DAIHATSU | Charade 1.5i 16V               | (G203)         | 93    | 98 | ✓ |
| DAIHATSU | Charade 1.6i 16V GTI           | (G200/201/202) | 93    | 98 | ✓ |
| DAIHATSU | Gran Move 1.5i 16V             | (G303, G313)   | 10/96 | 02 | ✓ |
| DAIHATSU | Gran Move 1.6i                 | (G301)         | 98    | 02 | ✓ |
| DAIHATSU | Terios 1.3i 16V                | (J100)         | 01    | 04 | ✓ |
| DAIHATSU | Terios 4WD 1.3i 16V            | (J100)         | 97    | 04 | ✓ |

**901 427**

|          |           |       |       |    |   |
|----------|-----------|-------|-------|----|---|
| DAIHATSU | Cuore 850 | (L80) | 08/85 | 90 | ✓ |
|----------|-----------|-------|-------|----|---|

**901 427**

|          |               |            |       |       |   |
|----------|---------------|------------|-------|-------|---|
| DAIHATSU | Cuore 850     | (L201)     | 03/90 | 94    | ✓ |
| DAIHATSU | Cuore 850     | (L501)     | 10/94 | 98    | ✓ |
| DAIHATSU | Cuore 850 4WD | (L80)      | 87    | 90    | ✓ |
| DAIHATSU | Domino 850    | (L80, L81) | 09/85 | 06/90 | ✓ |
| DAIHATSU | Domino 850    | (L201)     | 10/90 | 94    | ✓ |
| DAIHATSU | Handi 850     | (L80)      | 09/85 | 90    | ✓ |
| DAIHATSU | Mira 850      | (L80)      | 10/85 | 06/90 | ✓ |
| DAIHATSU | Mira 850      | (L201)     | 10/90 | 94    | ✓ |
| DAIHATSU | Move 850      | (L601)     | 97    | 02    | ✓ |
| DAIHATSU | Move 1000     | (L901)     | 98    | 02    | ✓ |

**901 429**

|          |                         |                |       |    |   |
|----------|-------------------------|----------------|-------|----|---|
| DAIHATSU | Applause I 1.6i 16V     | (A101)         | 06/89 | 97 | ✓ |
| DAIHATSU | Applause I 1.6i 16V 4WD | (A111)         | 06/89 | 97 | ✓ |
| DAIHATSU | Applause II 1.6i 16V    |                | 07/97 | 02 | ✓ |
| DAIHATSU | Charade 1.0             | (G100/101/112) | 87    | 88 | ✓ |
| DAIHATSU | Charade 1.3i 16V        | (G102)         | 87    | 88 | ✓ |
| DAIHATSU | Charade 1.3i 16V 4WD    | (G112)         | 87    | 92 | ✓ |

**901 445**

|          |                     |               |       |       |   |
|----------|---------------------|---------------|-------|-------|---|
| DAIHATSU | Fourtrak 2.8 Diesel |               | 84    | 87    | ✓ |
| DAIHATSU | Rocky 4WD 2.0       | (F70,F80,F90) | 04/84 | 94    | ✓ |
| DAIHATSU | Rocky 4WD 2.0       | (F77,F87,F97) | 04/84 | 94    | ✓ |
| DAIHATSU | Rocky 4WD 2.5 D     | (F50, F60)    | 04/84 | 10/88 | ✓ |
| DAIHATSU | Rocky 4WD 2.8 D/TD  | (F70, F75)    | 84    | 98    | ✓ |
| DAIHATSU | Rocky 4WD 2.8 D/TD  | (F80, F85)    | 84    | 98    | ✓ |
| DAIHATSU | Rocky 4WD 2.8 TD    | (F73,F78,F98) | 05/93 | 98    | ✓ |
| DAIHATSU | Scat                |               | 84    | 10/88 | ✓ |
| DAIHATSU | Taft 1.6            | (F20, F25)    | 83    | 10/88 | ✓ |
| DAIHATSU | Taft 2.5 Diesel     | (F50, F55)    | 83    | 10/88 | ✓ |
| DAIHATSU | Taft 2.8 Diesel     | (F60, F65)    | 83    | 10/88 | ✓ |

**901 461**

|          |             |                 |    |    |   |
|----------|-------------|-----------------|----|----|---|
| DAIHATSU | Charade 1.0 | (G10, G20)      | 78 | 83 | ✓ |
| DAIHATSU | Charade 1.0 | (G11, G30, G21) | 83 | 86 | ✓ |

**901 549**

|          |                |        |       |       |   |
|----------|----------------|--------|-------|-------|---|
| DAIHATSU | Feroza 1.6 16V | (F300) | 10/88 | 05/97 | ✓ |
| DAIHATSU | Feroza 1.6 16V | (F310) | 05/92 | 05/97 | ✓ |

**901 876**

|          |                   |       |       |    |   |
|----------|-------------------|-------|-------|----|---|
| DAIHATSU | Hijet 1000        | (S85) | 01/93 | 95 | ✓ |
| DAIHATSU | Hijet 1200 Diesel | (S85) | 10/95 | 98 | ✓ |
| DAIHATSU | Hijet 1300i 16V   | (S85) | 05/98 | 02 | ✓ |
| DAIHATSU | Hijet 4x4         | (S86) | 05/86 | 92 | ✓ |

**901 885**

|          |       |            |       |    |   |
|----------|-------|------------|-------|----|---|
| DAIHATSU | Hijet | (S8..)     | 10/86 | 87 | ✓ |
| DAIHATSU | Zebra | (S88, S89) | 88    | 91 | ✓ |

**901 890**

|          |                 |                      |    |    |   |
|----------|-----------------|----------------------|----|----|---|
| DAIHATSU | Hijet           | (S60, S70, S75, S77) | 81 | 86 | ✓ |
| DAIHATSU | Hijet 850, 1000 | (S84, S85)           | 88 | 92 | ✓ |

**902 443**

|          |                     |               |       |       |   |
|----------|---------------------|---------------|-------|-------|---|
| DAIHATSU | Feroza 1.6 16V      | (F300)        | 10/88 | 05/97 | ✓ |
| DAIHATSU | Feroza 1.6 16V      | (F310)        | 05/92 | 05/97 | ✓ |
| DAIHATSU | Fourtrak 2.8 Diesel |               | 84    | 87    | ✓ |
| DAIHATSU | Rocky 4WD 2.0       | (F70,F80,F90) | 04/84 | 94    | ✓ |
| DAIHATSU | Rocky 4WD 2.8 D/TD  | (F70, F75)    | 84    | 98    | ✓ |
| DAIHATSU | Rocky 4WD 2.8 D/TD  | (F80, F85)    | 84    | 98    | ✓ |

**902 457**

|          |                      |                 |    |    |   |
|----------|----------------------|-----------------|----|----|---|
| DAIHATSU | Charade 1.0          | (G11, G30, G21) | 83 | 86 | ✓ |
| DAIHATSU | Charade 1.0          | (G100/101/112)  | 87 | 93 | ✓ |
| DAIHATSU | Charade 1.0          | (G200/201/202)  | 93 | 96 | ✓ |
| DAIHATSU | Charade 1.3i 16V     | (G102)          | 87 | 92 | ✓ |
| DAIHATSU | Charade 1.3i 16V     | (G200/201/202)  | 93 | 98 | ✓ |
| DAIHATSU | Charade 1.6i 16V GTI | (G200/201/202)  | 93 | 98 | ✓ |

**902 459**

|          |               |            |       |       |   |
|----------|---------------|------------|-------|-------|---|
| DAIHATSU | Charade 1.0   | (G10, G20) | 78    | 83    | ✓ |
| DAIHATSU | Cuore 850     | (L80)      | 08/85 | 90    | ✓ |
| DAIHATSU | Cuore 850     | (L201)     | 03/90 | 94    | ✓ |
| DAIHATSU | Cuore 850     | (L501)     | 10/94 | 98    | ✓ |
| DAIHATSU | Cuore 850 4WD | (L80)      | 87    | 90    | ✓ |
| DAIHATSU | Domino 850    | (L80, L81) | 09/85 | 06/90 | ✓ |
| DAIHATSU | Domino 850    | (L201)     | 10/90 | 94    | ✓ |
| DAIHATSU | Handi 850     | (L80)      | 09/85 | 90    | ✓ |
| DAIHATSU | Mira 850      | (L80)      | 10/85 | 06/90 | ✓ |
| DAIHATSU | Mira 850      | (L201)     | 10/90 | 94    | ✓ |
| DAIHATSU | Move 850      | (L601)     | 97    | 02    | ✓ |
| DAIHATSU | Move 1000     | (L901)     | 98    | 02    | ✓ |

**902 547**

|          |                    |              |       |    |   |
|----------|--------------------|--------------|-------|----|---|
| DAIHATSU | Charade 1.5i 16V   | (G203)       | 93    | 98 | ✓ |
| DAIHATSU | Gran Move 1.5i 16V | (G303, G313) | 10/96 | 02 | ✓ |
| DAIHATSU | Gran Move 1.6i     | (G301)       | 98    | 02 | ✓ |

**902 771**

|          |                    |              |       |    |   |
|----------|--------------------|--------------|-------|----|---|
| DAIHATSU | Charade 1.3i 16V   | (G102)       | 90    | 92 | ✓ |
| DAIHATSU | Charade 1.5i 16V   | (G203)       | 93    | 98 | ✓ |
| DAIHATSU | Gran Move 1.5i 16V | (G303, G313) | 10/96 | 02 | ✓ |
| DAIHATSU | Gran Move 1.6i     | (G301)       | 98    | 02 | ✓ |

**902 855**

|          |                  |               |       |    |   |
|----------|------------------|---------------|-------|----|---|
| DAIHATSU | Rocky 4WD 2.0    | (F77,F87,F97) | 04/84 | 94 | ✓ |
| DAIHATSU | Rocky 4WD 2.8 TD | (F73,F78,F98) | 05/93 | 98 | ✓ |

**902 891**

|          |            |            |    |       |   |
|----------|------------|------------|----|-------|---|
| DAIHATSU | Hijet      | (S75, S77) | 81 | 86    | ✓ |
| DAIHATSU | Hijet 850  | (S84)      | 88 | 92    | ✓ |
| DAIHATSU | Hijet 1000 | (S85)      | 88 | 09/93 | ✓ |

**902 901**

|          |                 |            |    |    |   |
|----------|-----------------|------------|----|----|---|
| DAIHATSU | Hijet           | (S60, S70) | 81 | 86 | ✓ |
| DAIHATSU | Hijet 850, 1000 | (S84, S85) | 88 | 92 | ✓ |

**902 908**

|          |            |       |       |    |   |
|----------|------------|-------|-------|----|---|
| DAIHATSU | Hijet 1000 | (S85) | 10/93 | 95 | ✓ |
| DAIHATSU | Hijet 4x4  | (S86) | 05/86 | 92 | ✓ |

**902 999**

|          |                 |        |    |    |   |
|----------|-----------------|--------|----|----|---|
| DAIHATSU | Sirion 1.0i 12V | (M100) | 98 | 04 | ✓ |
| DAIHATSU | Sirion 1.3i 16V | (M101) | 00 | 04 | ✓ |
| DAIHATSU | Terios 1.3i 16V | (J100) | 01 | 04 | ✓ |

**911 377**

|       |                         |            |       |       |   |
|-------|-------------------------|------------|-------|-------|---|
| HONDA | Capa 1.5 16V            |            | 98    | 04    | ✓ |
| HONDA | Civic 1.3 16V           | (EG3)      | 92    | 96    | ✓ |
| HONDA | Civic 1.4i 16V          | (EJ9)      | 96    | 01    | ✓ |
| HONDA | Civic 1.5i 16V          | (EG4, EG8) | 92    | 95    | ✓ |
| HONDA | Civic 1.5i 16V          | (EH2)      | 92    | 92    | ✓ |
| HONDA | Civic 1.6i 16V          | (EH3)      | 92    | 92    | ✓ |
| HONDA | Civic 1.6i 16V          | (EH9)      | 94    | 95    | ✓ |
| HONDA | Civic 1.6i 16V          | (EH9)      | 92    | 95    | ✓ |
| HONDA | Civic 1.6i 16V V-Tec    | (EG5)      | 92    | 95    | ✓ |
| HONDA | Civic Coupé 1.5i 16V DX | (EJ2)      | 93    | 93    | ✓ |
| HONDA | Civic Coupé 1.6i 16V DX | (EJ1)      | 93    | 93    | ✓ |
| HONDA | Civic del sol 1.5i 16V  | (EG1)      | 93    | 95    | ✓ |
| HONDA | Civic del sol 1.6i 16V  | (EH6)      | 93    | 95    | ✓ |
| HONDA | CR-X 1.6                | (EJ4)      | 09/95 | 02/01 | ✓ |
| HONDA | Jazz 1.2                | (GD)       | 02    | 04    | ✓ |
| HONDA | Jazz 1.4                | (GD)       | 02    | 04    | ✓ |
| HONDA | Logo 1.3                | (GA3)      | 99    | 03    | ✓ |

**911 383**

|       |                      |            |    |       |   |
|-------|----------------------|------------|----|-------|---|
| HONDA | Civic 1.4i 16V       | (MA8, MB2) | 95 | 01    | ✓ |
| HONDA | Civic 1.4i 16V       | (EP1)      | 01 | 05    | ✓ |
| HONDA | Civic 1.5i 16V       | (MA9, MB3) | 95 | 01/97 | ✓ |
| HONDA | Civic 1.5i 16V V-Tec | (EK3)      | 96 | 01    | ✓ |

**911 383**

|       |                                |              |       |       |   |
|-------|--------------------------------|--------------|-------|-------|---|
| HONDA | Civic 1.5i 16V                 | (EU1/2)      | 01    | 05    | ✓ |
| HONDA | Civic 1.6i 16V                 | (EG2, EG9)   | 92    | 96    | ✓ |
| HONDA | Civic 1.6i 16V                 | (EH1)        | 92    | 95    | ✓ |
| HONDA | Civic 1.6i 16V                 | (EH6)        | 92    | 96    | ✓ |
| HONDA | Civic 1.6i 16V                 | (EH9)        | 94    | 95    | ✓ |
| HONDA | Civic 1.6i 16V                 | (EK1)        | 96    | 02/01 | ✓ |
| HONDA | Civic 1.6i 16V                 | (MB1, MB4)   | 95    | 02/98 | ✓ |
| HONDA | Civic 1.6i 16V V-Tec           | (EG5)        | 94    | 95    | ✓ |
| HONDA | Civic 1.6i 16V V-Tec           | (EG6)        | 92    | 95    | ✓ |
| HONDA | Civic 1.6i 16V V-Tec           | (EK4)        | 96    | 02/01 | ✓ |
| HONDA | Civic 1.6i 16V, 1.7i 16V       | (EU_, EP_)   | 01    | 05    | ✓ |
| HONDA | Civic 1.7 CTDi                 | (EU_, EP_)   | 02    | 05    | ✓ |
| HONDA | Civic 1.8i 16V                 | (MB6)        | 97    | 02/01 | ✓ |
| HONDA | Civic 2.0i Turbo Diesel        | (MB7)        | 97    | 00    | ✓ |
| HONDA | Civic Coupé 1.5i 16V EX        | (EJ2)        | 94    | 94    | ✓ |
| HONDA | Civic Coupé 1.5i 16V EX & EX-S | (EJ2)        | 93    | 94    | ✓ |
| HONDA | Civic Coupé 1.6i 16V EX & EX-S | (EJ1)        | 93    | 93    | ✓ |
| HONDA | Civic Coupé 1.7i 16V           | (EM_)        | 01    | 05    | ✓ |
| HONDA | Civic Coupé 1.7i 16V V-Tec     | (EM_)        | 01    | 05    | ✓ |
| HONDA | Civic del sol 1.6i 16V         | (EG2)        | 94    | 95    | ✓ |
| HONDA | Civic del sol 1.6i 16V         | (EH6)        | 95    | 95    | ✓ |
| HONDA | CR-X 1.5                       | (EG1)        | 02/92 | 94    | ✓ |
| HONDA | CR-X 1.6                       | (EG2)        | 02/92 | 96    | ✓ |
| HONDA | CR-X 1.6                       | (EH6)        | 02/92 | 96    | ✓ |
| HONDA | CR-X 1.6                       | (EH6)        | 95    | 96    | ✓ |
| HONDA | HR-V 1.6 16V                   | (GH1/2/3/4)  | 99    | 02    | ✓ |
| HONDA | HR-V 1.6 16V 4WD               | (GH1/2/3/4)  | 99    | 02    | ✓ |
| HONDA | Integra 1.6                    | (DA5, DA7)   | 04/89 | 05/93 | ✓ |
| HONDA | Integra 1.6                    | (DB6/9, DC1) | 07/93 | 00    | ✓ |
| HONDA | Integra 1.8                    | (DB7/8, DC2) | 07/93 | 04/94 | ✓ |
| HONDA | Integra 1.8 Type R             | (DB8R, DC2R) | 10/95 | 00    | ✓ |
| HONDA | Prelude 2.2i 16V               | (BB8)        | 10/96 | 00    | ✓ |

**911 385**

|             |                          |            |    |    |   |
|-------------|--------------------------|------------|----|----|---|
| HONDA       | Accord 1.8               | (CB1)      | 90 | 97 | ✓ |
| HONDA       | Accord 2.0i 16V          | (CB3, CC7) | 90 | 97 | ✓ |
| HONDA       | Accord 2.2i 16V          | (CB7, CD7) | 90 | 97 | ✓ |
| HONDA       | Accord Aerodeck 2.0i 16V | (CC9)      | 92 | 98 | ✓ |
| HONDA       | Accord Aerodeck 2.0i 16V | (CE2)      | 94 | 98 | ✓ |
| HONDA       | Accord Aerodeck 2.2i 16V | (CB8)      | 90 | 98 | ✓ |
| HONDA       | Accord Aerodeck 2.2i 16V | (CE1)      | 94 | 98 | ✓ |
| HONDA       | Accord Coupé 2.0i 16V    | (CB7)      | 90 | 97 | ✓ |
| HONDA       | Accord Coupé 2.0i 16V    | (CC1)      | 92 | 97 | ✓ |
| ROVER GROUP | Rover 600                | (RH)       | 93 | 00 | ✓ |

**911 387**

|             |                       |       |    |    |   |
|-------------|-----------------------|-------|----|----|---|
| HONDA       | Accord 1.8            | (CB1) | 90 | 97 | ✓ |
| HONDA       | Accord 2.0i 16V       | (CB3) | 90 | 97 | ✓ |
| HONDA       | Accord 2.0i 16V       | (CC7) | 90 | 97 | ✓ |
| HONDA       | Accord 2.2i 16V       | (CB7) | 90 | 97 | ✓ |
| HONDA       | Accord Coupé 2.0i 16V | (CB7) | 90 | 97 | ✓ |
| ROVER GROUP | Rover 600             | (RH)  | 93 | 00 | ✓ |

**911 399**

|       |                        |             |       |       |   |
|-------|------------------------|-------------|-------|-------|---|
| HONDA | Legend 2.7i 24V        | (HS, KA3/4) | 11/87 | 90    | ✓ |
| HONDA | Prelude 2.0i 16V       | (BB3)       | 92    | 09/96 | ✓ |
| HONDA | Prelude 2.2i 16V V-Tec | (BB1)       | 92    | 09/96 | ✓ |
| HONDA | Prelude 2.3i 16V       | (BB2)       | 92    | 09/96 | ✓ |

**911 600**

|       |                    |            |    |    |   |
|-------|--------------------|------------|----|----|---|
| HONDA | Civic              |            | 84 | 87 | ✓ |
| HONDA | Civic 1.2          | (EC7, ED1) | 88 | 91 | ✓ |
| HONDA | Civic 1.3 16V      | (EC8)      | 88 | 91 | ✓ |
| HONDA | Civic 1.4 16V      | (EC9, ED2) | 88 | 91 | ✓ |
| HONDA | Civic 1.5i 16V     | (ED3, ED6) | 88 | 91 | ✓ |
| HONDA | Civic 1.6i 16V     | (ED7, ED4) | 88 | 91 | ✓ |
| HONDA | Civic 1.6i 16V 4WD | (EE5)      | 88 | 91 | ✓ |
| HONDA | Civic Shuttle      |            | 84 | 88 | ✓ |



**911 600**

|             |   |    |       |   |  |
|-------------|---|----|-------|---|--|
| HONDA       | Civic Shuttle 1.4, 1.5, 1.6 (EE1, 2, 4) | 88 | 91    | ✓ |  |
| HONDA       | Civic Shuttle 4WD                       | 85 | 90    | ✓ |  |
| HONDA       | CR-X 1.5, 1.6 (EF6, EF7)                | 90 | 02/92 | ✓ |  |
| HONDA       | Integra 1.5 (DA2/4)                     | 86 | 88    | ✓ |  |
| ROVER GROUP | Rover 200 (XH)                          | 84 | 89    | ✓ |  |

**911 647**

|       |                               |       |       |   |  |
|-------|-------------------------------|-------|-------|---|--|
| HONDA | Civic 1.3, 1.4, 1.8, 2.2 CTDi | 01/06 | 12/06 | ✓ |  |
| HONDA | CR-V II 2.0i 16V 4WD          | 07/02 | 04    | ✓ |  |
| HONDA | FR-V 1.7, 2.0                 | 02/05 | 12/06 | ✓ |  |

**911 777**

|       |                                  |       |       |   |  |
|-------|----------------------------------|-------|-------|---|--|
| HONDA | CR-X 1.6 (EF8)                   | 90    | 02/92 | ✓ |  |
| HONDA | Integra 1.6 (DA5, DA6, DA7, DA8) | 04/89 | 05/93 | ✓ |  |
| HONDA | Integra 1.8 (DB1)                | 10/91 | 07/93 | ✓ |  |
| HONDA | Prelude 2.0i 16V 4WS (BA4)       | 88    | 92    | ✓ |  |

**911 802**

|       |                                  |       |       |   |  |
|-------|----------------------------------|-------|-------|---|--|
| HONDA | Accord 1.6i 16V (CG)             | 10/98 | 03    | ✓ |  |
| HONDA | Accord 1.8i 16V (CG, CH)         | 10/98 | 03    | ✓ |  |
| HONDA | Accord 2.0i 16V V-Tec (CG)       | 10/98 | 01/01 | ✓ |  |
| HONDA | Accord 2.0 TDi (CF1)             | 96    | 98    | ✓ |  |
| HONDA | Accord 2.0 Turbo DI (CG, CH)     | 99    | 01/03 | ✓ |  |
| HONDA | Accord 2.2i 16V Type-R (CG)      | 02/99 | 03    | ✓ |  |
| HONDA | Accord 2.3i 16V (CG, CH)         | 01    | 01/03 | ✓ |  |
| HONDA | Accord Coupé 2.0i 16V (CG)       | 98    | 03    | ✓ |  |
| HONDA | Accord Coupé 3.0i V6 24V (CG)    | 98    | 03    | ✓ |  |
| HONDA | Civic 1.4iS (EP1)                | 01    | 05    | ✓ |  |
| HONDA | Civic 2.0i 16V Type-R (EU_, EP_) | 01    | 05    | ✓ |  |
| HONDA | Civic 2.0i 16V Sport (EU_, EP_)  | 04    | 05    | ✓ |  |
| HONDA | CR-V 2.0i 16V 2WD (RD2)          | 05/00 | 02/01 | ✓ |  |
| HONDA | CR-V 2.0i 16V 4WD (RD1, RD3)     | 10/95 | 02/01 | ✓ |  |
| HONDA | Prelude 2.0i 16V (BB9)           | 10/96 | 00    | ✓ |  |
| HONDA | Prelude 2.2i 16V (BB6)           | 10/96 | 00    | ✓ |  |

**911 831**

|       |                                   |       |       |   |  |
|-------|-----------------------------------|-------|-------|---|--|
| HONDA | Accord 2.0, 2.4 (CL7, CL8)        | 02/03 | 12/06 | ✓ |  |
| HONDA | Accord Tourer 2.0, 2.4 (CM1, CM2) | 04/03 | 12/06 | ✓ |  |

**911 968**

|       |                          |       |    |   |  |
|-------|--------------------------|-------|----|---|--|
| HONDA | Odyssey 2.2i 16V (RA1/2) | 09/94 | 00 | ✓ |  |
| HONDA | Odyssey 2.3i 16V (RA3/4) | 09/97 | 00 | ✓ |  |
| HONDA | Odyssey 3.0i 24V (RA5)   | 09/97 | 00 | ✓ |  |
| HONDA | Shuttle 2.2i 16V (RA18)  | 06/95 | 00 | ✓ |  |
| HONDA | Shuttle 2.3i 16V (RA38)  | 11/97 | 00 | ✓ |  |

**911 969**

|       |                              |       |    |   |  |
|-------|------------------------------|-------|----|---|--|
| HONDA | Legend 3.2i 24V DOHC (KA7/8) | 10/90 | 98 | ✓ |  |
| HONDA | Legend 3.5i 24V DOHC (KA9)   | 04/96 | 00 | ✓ |  |

**912 191**

|       |                               |       |       |   |  |
|-------|-------------------------------|-------|-------|---|--|
| HONDA | Civic 1.4i 16V (MA8, MB2)     | 95    | 01    | ✓ |  |
| HONDA | Civic 1.5i 16V (MA9, MB3)     | 95    | 01/97 | ✓ |  |
| HONDA | Civic 1.5i 16V V-Tec (EK3)    | 96    | 01    | ✓ |  |
| HONDA | Civic 1.6i 16V (EH9)          | 92    | 95    | ✓ |  |
| HONDA | Civic 1.6i 16V (EK1)          | 96    | 02/01 | ✓ |  |
| HONDA | Civic 1.6i 16V V-Tec (EG5)    | 92    | 95    | ✓ |  |
| HONDA | Civic 2.0i Turbo Diesel (MB7) | 97    | 00    | ✓ |  |
| HONDA | Civic del sol 1.6i 16V (EG2)  | 94    | 95    | ✓ |  |
| HONDA | Civic del sol 1.6i 16V (EH6)  | 93    | 95    | ✓ |  |
| HONDA | CR-X 1.6 (EG2)                | 02/92 | 96    | ✓ |  |

**912 193**

|       |                            |    |       |   |  |
|-------|----------------------------|----|-------|---|--|
| HONDA | Civic 1.4i 16V (EJ9)       | 96 | 02/01 | ✓ |  |
| HONDA | Civic 1.5i 16V V-Tec (EK3) | 96 | 01    | ✓ |  |
| HONDA | Civic 1.6i 16V (EK1)       | 96 | 02/01 | ✓ |  |

**912 292**

|       |                                |    |    |   |  |
|-------|--------------------------------|----|----|---|--|
| HONDA | Accord 2.2i 16V (CD7)          | 94 | 97 | ✓ |  |
| HONDA | Accord Aerodeck 2.0i 16V (CE2) | 94 | 98 | ✓ |  |

**912 292**

|       |                                |    |    |   |  |
|-------|--------------------------------|----|----|---|--|
| HONDA | Accord Aerodeck 2.2i 16V (CE1) | 94 | 98 | ✓ |  |
|-------|--------------------------------|----|----|---|--|

**912 294**

|       |                                 |       |    |   |  |
|-------|---------------------------------|-------|----|---|--|
| HONDA | Integra 1.8 Type R (DB8R, DC2R) | 10/95 | 00 | ✓ |  |
|-------|---------------------------------|-------|----|---|--|

**912 295**

|       |                        |       |       |   |  |
|-------|------------------------|-------|-------|---|--|
| HONDA | Civic 1.8i 16V (MB6)   | 97    | 02/01 | ✓ |  |
| HONDA | Prelude 2.0i 16V (BB9) | 10/96 | 00    | ✓ |  |
| HONDA | Prelude 2.2i 16V (BB6) | 10/96 | 00    | ✓ |  |

**912 296**

|       |                             |       |    |   |  |
|-------|-----------------------------|-------|----|---|--|
| HONDA | Prelude 2.0i 16V (BB9)      | 10/96 | 00 | ✓ |  |
| HONDA | Prelude 2.2i 16V (BB6, BB8) | 10/96 | 00 | ✓ |  |

**912 401**

|       |                              |    |       |   |  |
|-------|------------------------------|----|-------|---|--|
| HONDA | Prelude 2.0i 16V (BB3)       | 92 | 09/96 | ✓ |  |
| HONDA | Prelude 2.2i 16V V-Tec (BB1) | 92 | 09/96 | ✓ |  |
| HONDA | Prelude 2.3i 16V (BB2)       | 92 | 09/96 | ✓ |  |

**912 403**

|       |                              |    |       |   |  |
|-------|------------------------------|----|-------|---|--|
| HONDA | Prelude 2.0i 16V (BB3)       | 92 | 09/96 | ✓ |  |
| HONDA | Prelude 2.2i 16V V-Tec (BB1) | 92 | 09/96 | ✓ |  |
| HONDA | Prelude 2.3i 16V (BB2)       | 92 | 09/96 | ✓ |  |

**912 423**

|       |                                   |       |       |   |  |
|-------|-----------------------------------|-------|-------|---|--|
| HONDA | Civic 1.4i 16V (MA8, MB2)         | 95    | 01    | ✓ |  |
| HONDA | Civic 1.5i 16V (MA9, MB3)         | 95    | 01/97 | ✓ |  |
| HONDA | Civic 1.5i 16V V-Tec (EK3)        | 96    | 01    | ✓ |  |
| HONDA | Civic 1.6i 16V (EG2, EG9, EH6)    | 92    | 96    | ✓ |  |
| HONDA | Civic 1.6i 16V (EH9)              | 94    | 95    | ✓ |  |
| HONDA | Civic 1.6i 16V (EK1)              | 96    | 02/01 | ✓ |  |
| HONDA | Civic 1.6i 16V (MB1, MB4)         | 95    | 02/98 | ✓ |  |
| HONDA | Civic 1.6i 16V V-Tec (EG5)        | 94    | 95    | ✓ |  |
| HONDA | Civic 1.6i 16V V-Tec (EG6)        | 92    | 95    | ✓ |  |
| HONDA | Civic 1.6i 16V V-Tec (EK4)        | 96    | 02/01 | ✓ |  |
| HONDA | Civic Coupé 1.5i 16V EX (EJ2)     | 94    | 94    | ✓ |  |
| HONDA | Civic del sol 1.6i 16V (EG2, EH6) | 95    | 95    | ✓ |  |
| HONDA | CR-X 1.6 (EG2)                    | 02/92 | 96    | ✓ |  |
| HONDA | CR-X 1.6 (EH6)                    | 95    | 96    | ✓ |  |

**912 473**

|       |                     |    |       |   |  |
|-------|---------------------|----|-------|---|--|
| HONDA | Accord 1.8 (AD)     | 84 | 85    | ✓ |  |
| HONDA | Prelude 1.8 EX (AB) | 83 | 04/87 | ✓ |  |

**912 515**

|         |                     |       |       |   |  |
|---------|---------------------|-------|-------|---|--|
| HONDA   | Accord 1.6          | 82    | 83    | ✓ |  |
| HONDA   | Accord 1.6 (AC)     | 83    | 03/84 | ✓ |  |
| HONDA   | Accord 1.6 (AC)     | 04/84 | 85    | ✓ |  |
| HONDA   | Accord 1.8 (AD)     | 84    | 85    | ✓ |  |
| HONDA   | Civic               | 80    | 83    | ✓ |  |
| HONDA   | Jazz (AA)           | 82    | 86    | ✓ |  |
| HONDA   | Prelude 1.6 (SN)    | 79    | 82    | ✓ |  |
| HONDA   | Quintet 1.6 EX (SU) | 80    | 83    | ✓ |  |
| TRIUMPH | Acclaim             | 81    | 84    | ✓ |  |

**912 518**

|       |                                  |    |    |   |  |
|-------|----------------------------------|----|----|---|--|
| HONDA | Accord 1.6, 2.0 (CA4, CA5)       | 89 | 89 | ✓ |  |
| HONDA | Accord Aerodeck 2.0 (CA5)        | 86 | 92 | ✓ |  |
| HONDA | Concerto 1.5i 16V, 1.6i 16V (HW) | 89 | 95 | ✓ |  |

**912 527**

|       |                              |       |       |   |  |
|-------|------------------------------|-------|-------|---|--|
| HONDA | CR-V 2.0i 16V 2WD (RD2)      | 05/00 | 02/01 | ✓ |  |
| HONDA | CR-V 2.0i 16V 4WD (RD1, RD3) | 10/95 | 02/01 | ✓ |  |
| HONDA | CR-V II 2.0i 16V 4WD         | 07/02 | 04    | ✓ |  |

**912 530**

|       |                      |    |    |   |  |
|-------|----------------------|----|----|---|--|
| HONDA | Civic                | 85 | 87 | ✓ |  |
| HONDA | Civic 1.2 (EC7, ED1) | 88 | 91 | ✓ |  |
| HONDA | Civic 1.3 16V (EC8)  | 88 | 91 | ✓ |  |
| HONDA | Civic 1.3 16V (EG3)  | 92 | 96 | ✓ |  |

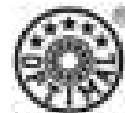

**912 530**

|             |                                |            |       |       |   |
|-------------|--------------------------------|------------|-------|-------|---|
| HONDA       | Civic 1.4 16V                  | (EC9, ED2) | 88    | 91    | ✓ |
| HONDA       | Civic 1.4i 16V                 | (EJ9)      | 96    | 01    | ✓ |
| HONDA       | Civic 1.5i 16V                 | (ED3, ED6) | 88    | 91    | ✓ |
| HONDA       | Civic 1.5i 16V                 | (EG4, EG8) | 92    | 95    | ✓ |
| HONDA       | Civic 1.5i 16V                 | (EH2)      | 92    | 92    | ✓ |
| HONDA       | Civic 1.5i 16V V-Tec           | (EK3)      | 96    | 01    | ✓ |
| HONDA       | Civic 1.6i 16V                 | (ED7, ED4) | 88    | 91    | ✓ |
| HONDA       | Civic 1.6i 16V 4WD             | (EE5)      | 88    | 91    | ✓ |
| HONDA       | Civic 1.6i 16V                 | (EH3)      | 92    | 92    | ✓ |
| HONDA       | Civic 1.6i 16V                 | (EH6)      | 92    | 96    | ✓ |
| HONDA       | Civic 1.6i 16V                 | (EH9)      | 94    | 95    | ✓ |
| HONDA       | Civic 1.6i 16V                 | (EK1)      | 96    | 02/01 | ✓ |
| HONDA       | Civic Coupé 1.5i 16V DX        | (EJ2)      | 93    | 93    | ✓ |
| HONDA       | Civic Coupé 1.5i 16V EX & EX-S | (EJ2)      | 93    | 94    | ✓ |
| HONDA       | Civic Coupé 1.6i 16V DX        | (EJ1)      | 93    | 93    | ✓ |
| HONDA       | Civic Coupé 1.6i 16V EX & EX-S | (EJ1)      | 93    | 93    | ✓ |
| HONDA       | Civic del sol 1.5i 16V         | (EG1)      | 93    | 95    | ✓ |
| HONDA       | Civic Shuttle                  |            | 85    | 87    | ✓ |
| HONDA       | CR-X 1.6                       | (ED8, ED9) | 88    | 90    | ✓ |
| HONDA       | CR-X 1.6                       | (EH6)      | 02/92 | 96    | ✓ |
| HONDA       | Integra 1.5                    | (DA2/4)    | 86    | 88    | ✓ |
| HONDA       | Integra 1.6                    | (DA5, DA7) | 04/89 | 05/93 | ✓ |
| HONDA       | Logo 1.3                       | (GA3)      | 99    | 03    | ✓ |
| ROVER GROUP | Rover 200                      | (XH)       | 85    | 89    | ✓ |

**912 532**

|             |                             |            |    |    |   |
|-------------|-----------------------------|------------|----|----|---|
| HONDA       | Accord 1.6                  | (CA4)      | 86 | 87 | ✓ |
| HONDA       | Accord 1.6                  | (CA4)      | 88 | 89 | ✓ |
| HONDA       | Accord 2.0                  | (CA5)      | 86 | 89 | ✓ |
| HONDA       | Accord Aerodeck 2.0         | (CA5)      | 86 | 92 | ✓ |
| HONDA       | Civic Shuttle               |            | 88 | 88 | ✓ |
| HONDA       | Civic Shuttle 1.4, 1.5      | (EE1, EE2) | 88 | 91 | ✓ |
| HONDA       | Concerto 1.5i 16V, 1.6i 16V | (HW)       | 89 | 95 | ✓ |
| ROVER GROUP | Cabiolet                    | (XW)       | 92 | 99 | ✓ |

**912 545**

|       |                      |       |    |    |   |
|-------|----------------------|-------|----|----|---|
| HONDA | Prelude 2.0i 16V 4WS | (BA4) | 88 | 92 | ✓ |
|-------|----------------------|-------|----|----|---|

**912 775**

|       |                       |            |    |    |   |
|-------|-----------------------|------------|----|----|---|
| HONDA | Accord 1.8            | (CB1)      | 90 | 97 | ✓ |
| HONDA | Accord 2.0i 16V       | (CB3, CC7) | 90 | 97 | ✓ |
| HONDA | Accord 2.2i 16V       | (CB7)      | 90 | 97 | ✓ |
| HONDA | Accord Coupé 2.0i 16V | (CC1)      | 92 | 97 | ✓ |

**912 786**

|       |                          |            |    |    |   |
|-------|--------------------------|------------|----|----|---|
| HONDA | Civic 1.4i 16V, 1.4 iS   | (EP1)      | 01 | 05 | ✓ |
| HONDA | Civic 1.6i 16V, 1.7i 16V | (EU_, EP_) | 01 | 05 | ✓ |
| HONDA | Civic 1.7 CTDi           | (EU_, EP_) | 02 | 05 | ✓ |

**912 803**

|       |                 |       |    |    |   |
|-------|-----------------|-------|----|----|---|
| HONDA | Accord 1.8      | (CB1) | 90 | 97 | ✓ |
| HONDA | Accord 2.0i 16V | (CB3) | 90 | 97 | ✓ |
| HONDA | Accord 2.2i 16V | (CB7) | 90 | 97 | ✓ |

**912 804**

|       |                        |          |       |       |   |
|-------|------------------------|----------|-------|-------|---|
| HONDA | Accord 1.6i 16V        | (CG)     | 10/98 | 03    | ✓ |
| HONDA | Accord 1.8i 16V        | (CG, CH) | 10/98 | 03    | ✓ |
| HONDA | Accord 2.0i 16V V-Tec  | (CG)     | 10/98 | 01/01 | ✓ |
| HONDA | Accord 2.0 TDi         | (CF1)    | 96    | 98    | ✓ |
| HONDA | Accord 2.0 Turbo DI    | (CG, CH) | 99    | 01/03 | ✓ |
| HONDA | Accord 2.2i 16V Type-R | (CG)     | 02/99 | 03    | ✓ |
| HONDA | Accord 2.3i 16V        | (CG, CH) | 01    | 01/03 | ✓ |
| HONDA | Accord Coupé 2.0i 16V  | (CG)     | 98    | 03    | ✓ |

**912 809**

|       |                  |             |    |    |   |
|-------|------------------|-------------|----|----|---|
| HONDA | HR-V 1.6 16V     | (GH1/2/3/4) | 99 | 02 | ✓ |
| HONDA | HR-V 1.6 16V 4WD | (GH1/2/3/4) | 99 | 02 | ✓ |

**912 991**

|       |                  |        |       |    |   |
|-------|------------------|--------|-------|----|---|
| HONDA | Shuttle 2.2i 16V | (RA18) | 06/95 | 00 | ✓ |
| HONDA | Shuttle 2.3i 16V | (RA38) | 11/97 | 00 | ✓ |

**912 992**

|       |                      |         |       |    |   |
|-------|----------------------|---------|-------|----|---|
| HONDA | Legend 3.2i 24V DOHC | (KA7/8) | 10/90 | 98 | ✓ |
| HONDA | Legend 3.5i 24V DOHC | (KA9)   | 04/96 | 00 | ✓ |

**920 752**

|             |                              |                       |       |       |   |
|-------------|------------------------------|-----------------------|-------|-------|---|
| HYUNDAI     | Pony I                       |                       | 82    | 90    | ✓ |
| HYUNDAI     | Stellar 1.6                  | (KSC)                 | 12/86 | 87    | ✓ |
| HYUNDAI     | Stellar 1.6                  | (MIP)                 | 01/87 | 92    | ✓ |
| HYUNDAI     | Stellar 1.8, 2.0             | (MPI, FBM)            | 88    | 92    | ✓ |
| HYUNDAI     | Pony Pickup 1.2              |                       | 82    | 92    | ✓ |
| HYUNDAI     | Pony Pickup 1.5              |                       | 86    | 88    | ✓ |
| MIITSUBISHI | Colt 1.2, 1.4                | (A15)                 | 79    | 84    | ✓ |
| MIITSUBISHI | Colt 1.4 Turbo               | (A15)                 | 82    | 84    | ✓ |
| MIITSUBISHI | Cordia                       | (A212A)               | 83    | 86    | ✓ |
| MIITSUBISHI | Galant 1.6                   | (A12, A16)            | 78    | 84    | ✓ |
| MIITSUBISHI | Galant 1.6                   | (E31)                 | 12/87 | 91    | ✓ |
| MIITSUBISHI | Galant 1.8                   | (E32)                 | 12/87 | 91    | ✓ |
| MIITSUBISHI | Galant 1.8 Turbo Diesel      | (E34)                 | 12/87 | 09/92 | ✓ |
| MIITSUBISHI | Galant 2.0                   | (E15)                 | 85    | 87    | ✓ |
| MIITSUBISHI | Galant 2.4                   | (E16)                 | 87    | 88    | ✓ |
| MIITSUBISHI | Galant Sapporo 1.6           | (A121A)               | 79    | 84    | ✓ |
| MIITSUBISHI | Galant Sigma 1.6             | (A121A)               | 77    | 84    | ✓ |
| MIITSUBISHI | Galant Sigma 2.0             | (A123A)               | 77    | 84    | ✓ |
| MIITSUBISHI | Galant Sigma 2.0             | (A123V)               | 78    | 12/78 | ✓ |
| MIITSUBISHI | Lancer 1.2                   | (A17)                 | 75    | 84    | ✓ |
| MIITSUBISHI | Lancer 1.4                   | (A72)                 | 75    | 79    | ✓ |
| MIITSUBISHI | Lancer 1.6                   | (A17)                 | 77    | 84    | ✓ |
| MIITSUBISHI | Lancer F 1.2                 | (A15)                 | 82    | 84    | ✓ |
| MIITSUBISHI | Lancer F 1.4                 | (A15)                 | 83    | 84    | ✓ |
| MIITSUBISHI | Lancer F 1.4 Turbo           | (A17)                 | 82    | 84    | ✓ |
| MIITSUBISHI | Lancer F 1.5                 | (C12)                 | 86    | 92    | ✓ |
| MIITSUBISHI | Space Wagon 1.8              | (D04)                 | 06/86 | 05/91 | ✓ |
| MIITSUBISHI | Space Wagon 1.8 Turbo Diesel | (D09)                 | 07/85 | 05/91 | ✓ |
| MIITSUBISHI | Tredia                       | (A211A, A212A)        | 82    | 90    | ✓ |
| MIITSUBISHI | Tredia                       | (A213A, A214A, A215A) | 84    | 90    | ✓ |

**921 215**

|         |                        |      |       |       |   |
|---------|------------------------|------|-------|-------|---|
| HYUNDAI | Coupe 2.7 V6 24V       | (GK) | 03/02 | 04    | ✓ |
| HYUNDAI | Elantra                |      | 00    | 05    | ✓ |
| HYUNDAI | Sonata III 2.0i 16V    | (EF) | 06/98 | 04    | ✓ |
| HYUNDAI | Sonata III 2.4i 16V    | (EF) | 03/98 | 04    | ✓ |
| HYUNDAI | Sonata III 2.5i V6 24V | (EF) | 06/98 | 04    | ✓ |
| HYUNDAI | XG                     |      | 98    | 04    | ✓ |
| KIA     | Cerato                 |      | 04/04 | 12/06 | ✓ |

**921 553**

|     |         |  |       |    |   |
|-----|---------|--|-------|----|---|
| KIA | Capital |  | 07/93 | 94 | ✓ |
|-----|---------|--|-------|----|---|

**921 555**

|     |                       |  |    |       |   |
|-----|-----------------------|--|----|-------|---|
| KIA | Retona 2.0 16V        |  | 00 | 04    | ✓ |
| KIA | Retona 2.0 TD         |  | 99 | 04    | ✓ |
| KIA | Sportage 2WD 2.0i 16V |  | 99 | 04    | ✓ |
| KIA | Sportage 4WD 2.0i     |  | 93 | 04/99 | ✓ |
| KIA | Sportage 4WD 2.0i 16V |  | 93 | 04    | ✓ |
| KIA | Sportage 4WD 2.0 TD   |  | 95 | 04    | ✓ |

**921 895**

|         |                                 |  |       |    |   |
|---------|---------------------------------|--|-------|----|---|
| HYUNDAI | Santa Fé 2.0i 16V, 2.0 CRDi     |  | 00    | 04 | ✓ |
| HYUNDAI | Santa Fé 2.0 CRDi 4x4, 2.4i 16V |  | 00    | 04 | ✓ |
| HYUNDAI | Santa Fé 2.4i 16V 4x4           |  | 00    | 04 | ✓ |
| HYUNDAI | Santa Fé 2.7 V6 24V 4x4         |  | 00    | 04 | ✓ |
| HYUNDAI | Trajeto 2.0i 16V, 2.7 V6 24V    |  | 00    | 03 | ✓ |
| HYUNDAI | Trajeto 2.0 CRDi                |  | 01    | 03 | ✓ |
| HYUNDAI | Tucson 2.0, 2.0 4WD, 2.7        |  | 08/04 | 05 | ✓ |



**SATZ-VERZEICHNIS  
KITS INDEX  
INDEX DES KITS**



**931 649**

|       |                             |    |    |   |  |
|-------|-----------------------------|----|----|---|--|
| ISUZU | Elf 250 3600 Diesel (NKR58) | 85 | 93 | ✓ |  |
| ISUZU | NPR 57, NKR, NPR 59         | 84 | 85 | ✓ |  |

**931 930**

|       |                             |    |    |   |  |
|-------|-----------------------------|----|----|---|--|
| ISUZU | Elf 150 2800 Diesel (NHR55) | 85 | 93 | ✓ |  |
|-------|-----------------------------|----|----|---|--|

**931 931**

|       |                          |       |       |   |  |
|-------|--------------------------|-------|-------|---|--|
| ISUZU | Panther 2.2 Diesel (TBR) | 09/90 | 01/96 | ✓ |  |
| ISUZU | Panther 2.5 Diesel (TBR) | 02/96 | 04    | ✓ |  |

**931 932**

|       |                             |    |    |   |  |
|-------|-----------------------------|----|----|---|--|
| ISUZU | Elf 250 2800 Diesel (NHR55) | 85 | 93 | ✓ |  |
| ISUZU | Elf 250 3600 Diesel (NKR58) | 85 | 93 | ✓ |  |

**932 665**

|       |                             |    |    |  |   |
|-------|-----------------------------|----|----|--|---|
| ISUZU | Elf 250 2800 Diesel (NHR55) | 85 | 93 |  | ✓ |
| ISUZU | Elf 250 3600 Diesel (NKR58) | 85 | 93 |  | ✓ |
| ISUZU | NPR 57, NKR                 | 84 | 85 |  | ✓ |

**932 794**

|       |                            |       |    |  |   |
|-------|----------------------------|-------|----|--|---|
| ISUZU | KB 4x2, 4x4                | 76    | 86 |  | ✓ |
| ISUZU | Trooper I (UBS)            | 83    | 85 |  | ✓ |
| ISUZU | Trooper I 2.2 D, 2.3 (UBS) | 01/86 | 88 |  | ✓ |
| ISUZU | WFR 4x2                    | 83    | 87 |  | ✓ |
| ISUZU | WFS 4x4                    | 86    | 87 |  | ✓ |

**932 864**

|          |                                      |       |       |  |   |
|----------|--------------------------------------|-------|-------|--|---|
| ISUZU    | Trooper I 2.6i, 2.8 TD (UBS)         | 88    | 91    |  | ✓ |
| ISUZU    | Trooper II 3.1 D, 3.2 (UB)           | 91    | 98    |  | ✓ |
| ISUZU    | Trooper III 3.0 DTi, 3.5i V6 24V     | 00    | 02    |  | ✓ |
| OPEL     | Monterey A 3.1 TD, 3.2i V6 24V       | 91    | 07/98 |  | ✓ |
| OPEL     | Monterey B 3.0 TDI 16V, 3.5i V6 26V  | 07/98 | 99    |  | ✓ |
| VAUXHALL | Monterey I 3.1 TD, 3.2i V6 24V       | 91    | 98    |  | ✓ |
| VAUXHALL | Monterey II 3.0 TDI 16V, 3.5i V6 26V | 98    | 99    |  | ✓ |

**932 933**

|       |                             |    |    |  |   |
|-------|-----------------------------|----|----|--|---|
| ISUZU | Elf 150 2800 Diesel (NHR55) | 85 | 93 |  | ✓ |
|-------|-----------------------------|----|----|--|---|

**932 934**

|       |                          |       |       |  |   |
|-------|--------------------------|-------|-------|--|---|
| ISUZU | Panther 2.2 Diesel (TBR) | 09/90 | 01/96 |  | ✓ |
| ISUZU | Panther 2.5 Diesel (TBR) | 02/96 | 04    |  | ✓ |

**940 371**

|       |  |       |       |   |   |
|-------|--|-------|-------|---|---|
| FORD  | Probe                                  | 10/93 | 98    | ✓ |   |
| KIA   | Carens I 1.8i 16V                      | 00    | 07/02 | ✓ |   |
| KIA   | Carens II 1.6i 16V, 1.8i 16V, 2.0 CRDi | 07/02 | 05    | ✓ |   |
| KIA   | Clarus 1.8i 16V, 2.0i 16V              | 95    | 01    | ✓ |   |
| KIA   | Clarus Wagon 1.8i 16V, 2.0i 16V        | 98    | 01    | ✓ |   |
| KIA   | Shuma II 1.6i 16V                      | 05/01 | 08/04 | ✓ |   |
| KIA   | Shuma II 1.8i 16V                      | 04/03 | 08/04 | ✓ |   |
| MAZDA | 323 4WD 1.8 16V (BG)                   | 06/89 | 95    | ✓ | ✓ |
| MAZDA | 6, 6 Sport (GG)                        | 02    | 04    | ✓ |   |
| MAZDA | 6 Sport 4WD (GG)                       | 02    | 04    | ✓ | ✓ |
| MAZDA | 6 Station Wagon (GY)                   | 02    | 04    | ✓ |   |
| MAZDA | 626 1.8i (GE)                          | 08/91 | 06/97 | ✓ |   |
| MAZDA | 626 1.8i 16V (GF)                      | 04/97 | 02    | ✓ |   |
| MAZDA | 626 1.9i 16V (GE)                      | 08/91 | 06/97 | ✓ |   |
| MAZDA | 626 1.9i 16V (GF)                      | 04/97 | 02    | ✓ |   |
| MAZDA | 626 2.0i 16V (GE)                      | 08/91 | 02    | ✓ |   |
| MAZDA | 626 2.0 Diesel (GE)                    | 03/92 | 97    | ✓ |   |
| MAZDA | 626 2.0i Turbo Diesel (GF)             | 98    | 02    | ✓ |   |
| MAZDA | 626 2.5i 24V (GE)                      | 08/91 | 98    | ✓ |   |
| MAZDA | 626 4WD / 4WS 1.8i (GE)                | 08/91 | 94    | ✓ | ✓ |
| MAZDA | 626 4WD / 4WS 2.0i 16V (GE)            | 08/91 | 05/97 | ✓ | ✓ |
| MAZDA | 626 4WD / 4WS 2.2i (GD)                | 09/89 | 10/91 | ✓ |   |
| MAZDA | 626 4WD / 4WS 2.5i 24V (GE)            | 08/91 | 94    | ✓ | ✓ |
| MAZDA | 626 Wagon 1.8i 16V, 1.9i 16V (GW)      | 10/97 | 02    | ✓ |   |
| MAZDA | 626 Wagon 2.0i 16V (GW)                | 10/97 | 02    | ✓ |   |
| MAZDA | 626 Wagon 2.0i Turbo Diesel (GW)       | 10/98 | 02    | ✓ |   |
| MAZDA | 626 Wagon 4WD 2.3i 16V (GY)            | 07/02 | 03    | ✓ | ✓ |

**940 371**

|       |                                       |       |       |   |   |
|-------|---------------------------------------|-------|-------|---|---|
| MAZDA | MPV II 2.0i 16V (LW)                  | 06/99 | 04    | ✓ |   |
| MAZDA | MPV II 2.0 Di, 2.3i 16V (LW)          | 02/02 | 04    | ✓ |   |
| MAZDA | MPV II 2.5 V6 24V, 3.0 V6 24V (LW)    | 02/02 | 04    | ✓ |   |
| MAZDA | MX 5 III (NC)                         | 03/05 | 12/06 |   | ✓ |
| MAZDA | MX-6 2.0i 16V, 2.5i 24V (GE)          | 07/91 | 97    | ✓ |   |
| MAZDA | MX-6 2.5i 24V 4WS (GE)                | 07/91 | 97    | ✓ | ✓ |
| MAZDA | RX-7 1.3 Wankel Twin Turbo (FD)       | 92    | 98    | ✓ |   |
| MAZDA | Xedos 6 1.6i 16V (CA)                 | 93    | 00    | ✓ |   |
| MAZDA | Xedos 6 2.0i V6 24V (CA)              | 92    | 00    | ✓ |   |
| MAZDA | Xedos 9 2.0i V6 24V, 2.5i V6 24V (TA) | 93    | 00    | ✓ |   |
| MAZDA | Xedos 9 2.3i V6 24V (TA)              | 95    | 00    | ✓ |   |

**940 632**

|       |                        |       |    |   |   |
|-------|------------------------|-------|----|---|---|
| MAZDA | 323 4WD 1.6 GT (BF)    | 10/85 | 95 | ✓ | ✓ |
| MAZDA | 323 Wagon 1.6 4WD (BW) | 89    | 95 | ✓ | ✓ |

**941 281**

|     |             |    |    |   |  |
|-----|-------------|----|----|---|--|
| KIA | Besta 2.2 D | 96 | 00 | ✓ |  |
|-----|-------------|----|----|---|--|

**941 565**

|       |                           |       |       |   |  |
|-------|---------------------------|-------|-------|---|--|
| MAZDA | B 1600, 2000, 2200 (UF)   | 85    | 87    | ✓ |  |
| MAZDA | B 2500 Diesel (UF)        | 96    | 06/99 | ✓ |  |
| MAZDA | B 2500 Diesel (UN)        | 06/99 | 02    | ✓ |  |
| MAZDA | E 1800, 2000, 2200 Diesel | 88    | 96    | ✓ |  |

**941 602**

|       |                                     |       |       |   |  |
|-------|-------------------------------------|-------|-------|---|--|
| MAZDA | 626 (GD)                            | 06/87 | 09/89 | ✓ |  |
| MAZDA | 626 1.6, 1.8, 2.0i 16V GT 4WS (GD)  | 09/89 | 10/91 | ✓ |  |
| MAZDA | 626 2.0, 2.0 Diesel, 2.2i (GD)      | 09/89 | 10/91 | ✓ |  |
| MAZDA | 626 4WD / 4WS 2.2i (GD)             | 09/89 | 10/91 | ✓ |  |
| MAZDA | 626 Wagon 1.8, 2.0, 2.0 Diesel (GV) | 10/89 | 97    | ✓ |  |
| MAZDA | 626 Wagon 2.2i, 4WD 2.2i (GV)       | 10/89 | 97    | ✓ |  |

**941 634**

|       |                        |       |       |   |  |
|-------|------------------------|-------|-------|---|--|
| MAZDA | 323 1.1, 1.3, 1.5 (BD) | 08/80 | 04/85 | ✓ |  |
|-------|------------------------|-------|-------|---|--|

**941 636**

|       |                                     |       |       |   |  |
|-------|-------------------------------------|-------|-------|---|--|
| KIA   | Avella                              | 94    | 98    | ✓ |  |
| KIA   | Pride 1.3i                          | 91    | 05    | ✓ |  |
| KIA   | Rio 1.3i, 1.5i 16V                  | 00    | 04    | ✓ |  |
| MAZDA | 121 I (DA)                          | 11/86 | 10/90 | ✓ |  |
| MAZDA | 323 1.1, 1.3, 1.4, 1.5, 1.6i (BF)   | 05/85 | 88    | ✓ |  |
| MAZDA | 323 1.7 Diesel (BF)                 | 05/85 | 88    | ✓ |  |
| MAZDA | 323 Wagon 1.5, 1.6, 1.7 Diesel (BW) | 86    | 95    | ✓ |  |

**941 687**

|       |                    |    |    |   |  |
|-------|--------------------|----|----|---|--|
| MAZDA | E 1400, 1800, 2000 | 88 | 96 | ✓ |  |
| MAZDA | Econovan 2WD 2200  | 84 | 85 | ✓ |  |

**941 700**

|       |                                   |       |       |   |  |
|-------|-----------------------------------|-------|-------|---|--|
| KIA   | Sephia 1.5i                       | 92    | 97    | ✓ |  |
| KIA   | Sephia 1.6i                       | 93    | 97    | ✓ |  |
| KIA   | Sephia 1.8i 16V                   | 94    | 97    | ✓ |  |
| KIA   | Shuma I 1.5i 16V, 1.8i 16V        | 97    | 08/01 | ✓ |  |
| MAZDA | 323 1.3i, 1.4i (BG)               | 06/89 | 95    | ✓ |  |
| MAZDA | 323 1.4i (BA)                     | 95    | 98    | ✓ |  |
| MAZDA | 323 1.4i, 1.5i 16V, 1.6i 16V (BJ) | 05/98 | 03    | ✓ |  |
| MAZDA | 323 1.5i 16V (BA)                 | 07/94 | 98    | ✓ |  |
| MAZDA | 323 1.6i (BG)                     | 06/89 | 98    | ✓ |  |
| MAZDA | 323 1.7 Diesel (BG)               | 06/89 | 95    | ✓ |  |
| MAZDA | 323 1.7 Turbo Diesel (BA)         | 05/94 | 98    | ✓ |  |
| MAZDA | 323 1.8i 16V (BG)                 | 06/89 | 95    | ✓ |  |
| MAZDA | 323 1.8i 16V (BA)                 | 07/94 | 98    | ✓ |  |
| MAZDA | 323 1.8i 16V (BJ)                 | 05/98 | 03    | ✓ |  |
| MAZDA | 323 1.9i 16V (BG)                 | 06/89 | 95    | ✓ |  |
| MAZDA | 323 1.9i 16V (BA)                 | 07/94 | 98    | ✓ |  |
| MAZDA | 323 1.9i 16V (BJ)                 | 05/98 | 03    | ✓ |  |
| MAZDA | 323 2.0i 16V (BJ)                 | 09/00 | 03    | ✓ |  |
| MAZDA | 323 2.0i 24V (BA)                 | 05/94 | 98    | ✓ |  |

**941 700**

|       |                                  |      |       |    |   |   |
|-------|----------------------------------|------|-------|----|---|---|
| MAZDA | 323 2.0 Diesel                   | (BA) | 10/96 | 98 | ✓ |   |
| MAZDA | 323 2.0 Diesel, 2.0 Turbo Diesel | (BJ) | 05/98 | 03 | ✓ |   |
| MAZDA | 323 4WD 1.3                      | (BG) | 06/89 | 95 | ✓ | ✓ |
| MAZDA | 323 4WD 1.6i                     | (BG) | 06/89 | 95 | ✓ | ✓ |
| MAZDA | 323 4WD 1.7 Diesel               | (BG) | 06/89 | 95 | ✓ | ✓ |
| MAZDA | 323 4WD 1.8                      | (BG) | 06/89 | 95 | ✓ | ✓ |
| MAZDA | MX-3                             | (EC) | 05/91 | 00 | ✓ |   |
| MAZDA | MX-5 II                          | (NB) | 05/98 | 04 |   | ✓ |
| MAZDA | Premacy                          | (CP) | 99    | 04 | ✓ |   |

**941 734**

|       |     |      |    |       |   |  |
|-------|-----|------|----|-------|---|--|
| MAZDA | 626 | (GC) | 83 | 06/87 | ✓ |  |
|-------|-----|------|----|-------|---|--|

**941 784**

|       |          |        |       |    |   |  |
|-------|----------|--------|-------|----|---|--|
| KIA   | Potentia |        | 11/93 | 94 | ✓ |  |
| MAZDA | 929      | (HC12) | 07/87 | 90 | ✓ |  |

**941 840**

|       |        |      |    |       |  |   |
|-------|--------|------|----|-------|--|---|
| MAZDA | MX-5 I | (NA) | 91 | 04/98 |  | ✓ |
|-------|--------|------|----|-------|--|---|

**941 842**

|       |                |              |       |       |   |   |
|-------|----------------|--------------|-------|-------|---|---|
| MAZDA | 121 II         | (DB)         | 11/90 | 03/96 |   | ✓ |
| MAZDA | 121 III        | (JASM, JBSM) | 03/96 | 98    |   | ✓ |
| MAZDA | Demio 1.4i 16V | (DW)         | 98    | 04    |   | ✓ |
| MAZDA | Demio 1.5i 16V | (DW)         | 00    | 04    |   | ✓ |
| MAZDA | MX-5 I         | (NA)         | 91    | 04/98 | ✓ |   |
| MAZDA | MX-5 II        | (NB)         | 05/98 | 04    | ✓ |   |

**941 862**

|       |                                  |      |       |       |  |   |
|-------|----------------------------------|------|-------|-------|--|---|
| FORD  | Probe                            |      | 10/93 | 98    |  | ✓ |
| MAZDA | 626 1.8i 16V, 1.9i 16V           | (GF) | 04/97 | 06/99 |  | ✓ |
| MAZDA | 626 1.8i, 1.9i 16V, 2.0i 16V     | (GE) | 05/94 | 06/97 |  | ✓ |
| MAZDA | 626 2.0 Diesel                   | (GE) | 03/92 | 97    |  | ✓ |
| MAZDA | 626 2.5i 24V                     | (GE) | 05/94 | 98    |  | ✓ |
| MAZDA | MX-6 2.0i 16V, 2.5i 24V          | (GE) | 07/91 | 97    |  | ✓ |
| MAZDA | Xedos 6 1.6i 16V                 | (CA) | 93    | 00    |  | ✓ |
| MAZDA | Xedos 6 2.0i V6 24V              | (CA) | 92    | 00    |  | ✓ |
| MAZDA | Xedos 9 2.0i V6 24V, 2.5i V6 24V | (TA) | 93    | 11/99 |  | ✓ |
| MAZDA | Xedos 9 2.3i V6 24V              | (TA) | 95    | 00    |  | ✓ |

**941 874**

|       |                |              |       |       |   |  |
|-------|----------------|--------------|-------|-------|---|--|
| MAZDA | 121 II         | (DB)         | 11/90 | 03/96 | ✓ |  |
| MAZDA | 121 III        | (JASM, JBSM) | 03/96 | 98    | ✓ |  |
| MAZDA | Demio 1.4i 16V | (DW)         | 98    | 04    | ✓ |  |
| MAZDA | Demio 1.5i 16V | (DW)         | 00    | 04    | ✓ |  |

**941 941**

|     |                             |  |    |    |   |  |
|-----|-----------------------------|--|----|----|---|--|
| KIA | Carnival 2.5 V6 24V, 2.9 TD |  | 99 | 04 | ✓ |  |
| KIA | Carnival 2.9 CRDi           |  | 01 | 04 | ✓ |  |
| KIA | Carnival 3.5 V6 24V         |  | 02 | 04 | ✓ |  |
| KIA | Sedona                      |  | 99 | 01 | ✓ |  |

**941 951**

|       |         |      |       |       |   |  |
|-------|---------|------|-------|-------|---|--|
| MAZDA | MX-5 I  | (NA) | 91    | 04/98 | ✓ |  |
| MAZDA | MX-5 II | (NB) | 05/98 | 04    | ✓ |  |

**941 963**

|     |       |  |    |    |   |  |
|-----|-------|--|----|----|---|--|
| KIA | K2700 |  | 98 | 01 | ✓ |  |
|-----|-------|--|----|----|---|--|

**941 967**

|       |                                  |      |       |    |   |  |
|-------|----------------------------------|------|-------|----|---|--|
| MAZDA | MPV I 2.5 Turbo Diesel, 3.0i 18V | (LV) | 95    | 99 | ✓ |  |
| MAZDA | MPV I 3.0i 24V DOHC              | (LV) | 07/94 | 99 | ✓ |  |

**942 177**

|       |                |      |       |       |  |   |
|-------|----------------|------|-------|-------|--|---|
| MAZDA | 121 II         | (DB) | 11/90 | 03/96 |  | ✓ |
| MAZDA | Demio 1.4i 16V | (DW) | 98    | 04    |  | ✓ |
| MAZDA | Demio 1.5i 16V | (DW) | 00    | 04    |  | ✓ |

**942 273**

|       |                 |      |    |    |  |   |
|-------|-----------------|------|----|----|--|---|
| MAZDA | 6, 6 Sport      | (GG) | 02 | 04 |  | ✓ |
| MAZDA | 6 Station Wagon | (GY) | 02 | 04 |  | ✓ |

**942 273**

|       |                                  |      |       |    |  |   |
|-------|----------------------------------|------|-------|----|--|---|
| MAZDA | 626 Wagon 1.8i 16V, 1.9i 16V     | (GW) | 10/97 | 02 |  | ✓ |
| MAZDA | 626 Wagon 2.0i 16V               | (GW) | 10/97 | 02 |  | ✓ |
| MAZDA | 626 Wagon 2.0i Turbo Diesel      | (GW) | 10/98 | 02 |  | ✓ |
| MAZDA | MPV II 2.0i 16V                  | (LW) | 06/99 | 04 |  | ✓ |
| MAZDA | MPV II 2.0 DI, 2.3i 16V          | (LW) | 02/02 | 04 |  | ✓ |
| MAZDA | MPV II 2.5 V6 24V, 3.0 V6 24V    | (LW) | 02/02 | 04 |  | ✓ |
| MAZDA | Premacy                          | (CP) | 99    | 04 |  | ✓ |
| MAZDA | Xedos 9 2.0i V6 24V, 2.5i V6 24V | (TA) | 11/99 | 00 |  | ✓ |

**942 291**

|       |                        |      |       |    |  |   |
|-------|------------------------|------|-------|----|--|---|
| MAZDA | 626 1.8i 16V, 1.9i 16V | (GF) | 07/99 | 02 |  | ✓ |
| MAZDA | 626 2.0i 16V           | (GF) | 04/97 | 02 |  | ✓ |
| MAZDA | 626 2.0i Turbo Diesel  | (GF) | 98    | 02 |  | ✓ |

**942 381**

|       |                         |      |       |       |  |   |
|-------|-------------------------|------|-------|-------|--|---|
| MAZDA | 626 1.8i                | (GE) | 08/91 | 06/97 |  | ✓ |
| MAZDA | 626 1.8i 16V            | (GF) | 04/97 | 02    |  | ✓ |
| MAZDA | 626 1.9i 16V            | (GE) | 08/91 | 06/97 |  | ✓ |
| MAZDA | 626 1.9i 16V            | (GF) | 04/97 | 02    |  | ✓ |
| MAZDA | 626 2.0i 16V            | (GE) | 08/91 | 06/97 |  | ✓ |
| MAZDA | 626 2.0i 16V            | (GF) | 04/97 | 02    |  | ✓ |
| MAZDA | 626 2.0 Diesel          | (GE) | 03/92 | 97    |  | ✓ |
| MAZDA | 626 2.0i Turbo Diesel   | (GF) | 98    | 02    |  | ✓ |
| MAZDA | 626 2.5i 24V            | (GE) | 08/91 | 98    |  | ✓ |
| MAZDA | MX-6 2.0i 16V, 2.5i 24V | (GE) | 07/91 | 97    |  | ✓ |
| MAZDA | Xedos 6 1.6i 16V        | (CA) | 93    | 00    |  | ✓ |
| MAZDA | Xedos 6 2.0i V6 24V     | (CA) | 92    | 00    |  | ✓ |

**942 566**

|       |     |      |    |       |  |   |
|-------|-----|------|----|-------|--|---|
| MAZDA | 626 | (GC) | 83 | 06/87 |  | ✓ |
|-------|-----|------|----|-------|--|---|

**942 568**

|       |                              |      |       |    |  |   |
|-------|------------------------------|------|-------|----|--|---|
| MAZDA | 323 1.1, 1.3, 1.4, 1.5, 1.6i | (BF) | 05/85 | 88 |  | ✓ |
| MAZDA | 323 1.7 Diesel               | (BF) | 05/85 | 88 |  | ✓ |

**942 569**

|       |                                  |      |       |    |  |   |
|-------|----------------------------------|------|-------|----|--|---|
| MAZDA | 323 1.3i, 1.4i                   | (BG) | 06/89 | 95 |  | ✓ |
| MAZDA | 323 1.4i                         | (BA) | 95    | 98 |  | ✓ |
| MAZDA | 323 1.4i                         | (BJ) | 05/98 | 03 |  | ✓ |
| MAZDA | 323 1.5i 16V                     | (BA) | 07/94 | 98 |  | ✓ |
| MAZDA | 323 1.5i 16V                     | (BJ) | 05/98 | 03 |  | ✓ |
| MAZDA | 323 1.6i                         | (BG) | 06/89 | 98 |  | ✓ |
| MAZDA | 323 1.6i 16V                     | (BJ) | 05/98 | 03 |  | ✓ |
| MAZDA | 323 1.7 Diesel                   | (BG) | 06/89 | 95 |  | ✓ |
| MAZDA | 323 1.7 Turbo Diesel, 2.0i 24V   | (BA) | 05/94 | 98 |  | ✓ |
| MAZDA | 323 1.8i 16V, 1.9i 16V           | (BG) | 06/89 | 95 |  | ✓ |
| MAZDA | 323 1.8i 16V, 1.9i 16V           | (BA) | 07/94 | 98 |  | ✓ |
| MAZDA | 323 2.0i 16V                     | (BJ) | 09/00 | 03 |  | ✓ |
| MAZDA | 323 2.0 Diesel                   | (BA) | 10/96 | 98 |  | ✓ |
| MAZDA | 323 2.0 Diesel, 2.0 Turbo Diesel | (BJ) | 05/98 | 03 |  | ✓ |
| MAZDA | MX-3                             | (EC) | 05/91 | 00 |  | ✓ |

**942 570**

|       |                              |      |       |    |  |   |
|-------|------------------------------|------|-------|----|--|---|
| MAZDA | 323 1.1, 1.3, 1.4, 1.5, 1.6i | (BF) | 05/85 | 88 |  | ✓ |
| MAZDA | 323 1.7 Diesel               | (BF) | 05/85 | 88 |  | ✓ |

**942 619**

|       |                    |         |    |    |  |   |
|-------|--------------------|---------|----|----|--|---|
| MAZDA | 929 L              | (LA4MV) | 80 | 86 |  | ✓ |
| MAZDA | E 1400, 1800, 2000 |         | 88 | 96 |  | ✓ |

**942 651**

|       |                      |  |    |    |  |   |
|-------|----------------------|--|----|----|--|---|
| MAZDA | E 1800, 2000, 2200   |  | 84 | 86 |  | ✓ |
| MAZDA | E 2000, E2200 Diesel |  | 88 | 96 |  | ✓ |

**942 672**

|       |                               |      |       |       |  |   |
|-------|-------------------------------|------|-------|-------|--|---|
| MAZDA | 626                           | (GD) | 06/87 | 09/89 |  | ✓ |
| MAZDA | 626 1.6, 1.8, 2.0, 2.0 Diesel | (GD) | 09/89 | 10/91 |  | ✓ |
| MAZDA | 626 2.2i                      | (GD) | 09/89 | 10/91 |  | ✓ |

**942 674**

|       |                   |      |       |       |   |
|-------|-------------------|------|-------|-------|---|
| MAZDA | 323 1.1, 1.3, 1.5 | (BD) | 08/80 | 04/85 | ✓ |
|-------|-------------------|------|-------|-------|---|

**942 695**

|       |                           |      |       |       |   |
|-------|---------------------------|------|-------|-------|---|
| MAZDA | B 2500 Diesel             | (UF) | 96    | 06/99 | ✓ |
| MAZDA | Courier                   |      | 03/85 | 86    | ✓ |
| MAZDA | E 1800, 2000, 2200 Diesel |      | 88    | 96    | ✓ |

**942 736**

|       |          |        |       |    |   |
|-------|----------|--------|-------|----|---|
| KIA   | Potentia |        | 11/93 | 94 | ✓ |
| MAZDA | 929      | (HC12) | 07/87 | 90 | ✓ |

**942 738**

|       |         |              |    |       |   |
|-------|---------|--------------|----|-------|---|
| KIA   | Capital |              | 90 | 06/93 | ✓ |
| KIA   | Concord |              | 92 | 94    | ✓ |
| MAZDA | 929     | (HB, HC, HD) | 82 | 86    | ✓ |

**942 768**

|       |            |      |       |       |   |
|-------|------------|------|-------|-------|---|
| KIA   | Avella     |      | 94    | 98    | ✓ |
| KIA   | Capital    |      | 90    | 06/93 | ✓ |
| KIA   | Capital    |      | 07/93 | 94    | ✓ |
| KIA   | Concord    |      | 92    | 94    | ✓ |
| KIA   | Pride 1.3i |      | 91    | 05    | ✓ |
| MAZDA | 121 I      | (DA) | 11/86 | 10/90 | ✓ |

**942 770**

|       |            |      |       |       |   |
|-------|------------|------|-------|-------|---|
| KIA   | Pride 1.3i |      | 91    | 05    | ✓ |
| MAZDA | 121 I      | (DA) | 11/86 | 10/90 | ✓ |

**942 773**

|       |                              |      |       |    |   |
|-------|------------------------------|------|-------|----|---|
| MAZDA | 323 1.3i, 1.4i               | (BG) | 06/89 | 95 | ✓ |
| MAZDA | 323 1.4i                     | (BA) | 95    | 98 | ✓ |
| MAZDA | 323 1.4i, 1.5i 16V, 1.6i 16V | (BJ) | 05/98 | 03 | ✓ |
| MAZDA | 323 1.5i 16V, 1.8i 16V       | (BA) | 07/94 | 98 | ✓ |
| MAZDA | 323 1.6i                     | (BG) | 06/89 | 98 | ✓ |
| MAZDA | 323 1.7 Diesel, 1.8i 16V     | (BG) | 06/89 | 95 | ✓ |
| MAZDA | 323 1.7 Turbo Diesel         | (BA) | 05/94 | 98 | ✓ |
| MAZDA | 323 1.8i 16V                 | (BJ) | 05/98 | 03 | ✓ |
| MAZDA | 323 1.9i 16V                 | (BG) | 06/89 | 95 | ✓ |
| MAZDA | 323 1.9i 16V                 | (BA) | 07/94 | 98 | ✓ |
| MAZDA | 323 1.9i 16V                 | (BJ) | 05/98 | 03 | ✓ |
| MAZDA | 323 2.0i 16V                 | (BJ) | 09/00 | 03 | ✓ |
| MAZDA | 323 2.0i 24V                 | (BA) | 05/94 | 98 | ✓ |
| MAZDA | 323 2.0 Diesel               | (BA) | 10/96 | 98 | ✓ |
| MAZDA | 323 2.0 Diesel               | (BJ) | 05/98 | 03 | ✓ |
| MAZDA | 323 2.0 Turbo Diesel         | (BJ) | 05/98 | 03 | ✓ |
| MAZDA | MX-3                         | (EC) | 05/91 | 00 | ✓ |

**942 818**

|       |                                |      |    |    |   |
|-------|--------------------------------|------|----|----|---|
| MAZDA | 323 Wagon 1.5, 1.6, 1.7 Diesel | (BW) | 86 | 95 | ✓ |
|-------|--------------------------------|------|----|----|---|

**942 820**

|       |                                |      |    |    |   |
|-------|--------------------------------|------|----|----|---|
| MAZDA | 323 Wagon 1.5, 1.6, 1.7 Diesel | (BW) | 86 | 95 | ✓ |
|-------|--------------------------------|------|----|----|---|

**942 942**

|     |                             |  |    |    |   |
|-----|-----------------------------|--|----|----|---|
| KIA | Carnival 2.5 V6 24V, 2.9 TD |  | 99 | 04 | ✓ |
| KIA | Carnival 2.9 CRDi           |  | 01 | 04 | ✓ |
| KIA | Carnival 3.5 V6 24V         |  | 02 | 04 | ✓ |
| KIA | Pregio 2.7 Diesel           |  | 99 | 02 | ✓ |
| KIA | Sedona                      |  | 99 | 01 | ✓ |

**942 987**

|       |                          |      |       |       |   |
|-------|--------------------------|------|-------|-------|---|
| MAZDA | 626 2.0i 16V GT 4WS      | (GD) | 09/89 | 10/91 | ✓ |
| MAZDA | 626 Wagon 1.8, 2.0, 2.2i | (GV) | 10/89 | 97    | ✓ |
| MAZDA | 626 Wagon 2.0 Diesel     | (GV) | 10/89 | 97    | ✓ |
| MAZDA | 626 Wagon 4WD 2.2i       | (GV) | 10/89 | 02    | ✓ |

**942 988**

|       |                            |      |    |    |   |
|-------|----------------------------|------|----|----|---|
| MAZDA | RX-7 1.3 Wankel Twin Turbo | (FD) | 92 | 98 | ✓ |
|-------|----------------------------|------|----|----|---|

**942 989**

|       |                                  |      |    |    |   |
|-------|----------------------------------|------|----|----|---|
| MAZDA | MPV I 2.5 Turbo Diesel, 3.0i 18V | (LV) | 95 | 99 | ✓ |
|-------|----------------------------------|------|----|----|---|

**942 989**

|       |                     |      |       |    |   |
|-------|---------------------|------|-------|----|---|
| MAZDA | MPV I 3.0i 24V DOHC | (LV) | 07/94 | 99 | ✓ |
|-------|---------------------|------|-------|----|---|

**951 282**

|         |                    |         |       |       |   |
|---------|--------------------|---------|-------|-------|---|
| HYUNDAI | Sonata II 1.8i     | (CF2)   | 05/93 | 06/98 | ✓ |
| HYUNDAI | Sonata II 2.0i 16V | (CF2/3) | 05/93 | 06/98 | ✓ |
| HYUNDAI | Sonata II 3.0i     | (CF3)   | 05/93 | 06/98 | ✓ |

**951 284**

|             |                            |        |    |    |   |
|-------------|----------------------------|--------|----|----|---|
| MINISUBISHI | L 200 2.5 Diesel           | (K64T) | 97 | 02 | ✓ |
| MINISUBISHI | L 200 2.5 Turbo Diesel     | (K74T) | 01 | 02 | ✓ |
| MINISUBISHI | L 200 4WD 2.5 Turbo Diesel | (K74T) | 97 | 02 | ✓ |

**951 409**

|             |                               |                    |       |       |   |
|-------------|-------------------------------|--------------------|-------|-------|---|
| MINISUBISHI | Carisma 1.6, 1.9 TD           | (DA1A)             | 95    | 02/99 | ✓ |
| MINISUBISHI | Colt 1.1                      |                    | 10/04 | 12/06 | ✓ |
| MINISUBISHI | Colt 1.3i                     | (CA1A, CB1A)       | 12/91 | 11/95 | ✓ |
| MINISUBISHI | Colt 1.3i 16V                 | (CJ1A, CK1A)       | 11/95 | 05/03 | ✓ |
| MINISUBISHI | Colt 1.3                      |                    | 06/04 | 12/06 | ✓ |
| MINISUBISHI | Colt 1.5                      | (CA2A, CB2A)       | 12/91 | 11/95 | ✓ |
| MINISUBISHI | Colt 1.5                      | (CB3A)             | 12/91 | 11/95 | ✓ |
| MINISUBISHI | Colt 1.5                      | (CJ2A)             | 11/95 | 05/03 | ✓ |
| MINISUBISHI | Colt 1.5                      |                    | 06/04 | 12/06 | ✓ |
| MINISUBISHI | Colt 1.5                      | (CK2A)             | 11/95 | 05/03 | ✓ |
| MINISUBISHI | Colt 1.5                      | (CZT)              | 06/04 | 12/06 | ✓ |
| MINISUBISHI | Colt 1.5 DI-D                 |                    | 08/04 | 12/06 | ✓ |
| MINISUBISHI | Colt 1.6i 16V                 | (CA4A, CB4A)       | 12/91 | 11/95 | ✓ |
| MINISUBISHI | Colt 1.6i 16V                 | (CJ4A, CK4A)       | 11/95 | 05/03 | ✓ |
| MINISUBISHI | Colt 1.8 GTI 16V              | (CA5A, CB5A)       | 12/91 | 11/95 | ✓ |
| MINISUBISHI | Colt 1.8 Diesel               | (CA5A, CB5A)       | 12/91 | 11/95 | ✓ |
| MINISUBISHI | Colt 2.0 Diesel               | (CB8A)             | 12/91 | 11/95 | ✓ |
| MINISUBISHI | Colt Cabriolet 1.5, 1.5 Turbo | (CZC)              | 05/06 | 12/06 | ✓ |
| MINISUBISHI | Lancer 1.3                    | (CA1A, CB1A)       | 12/91 | 11/94 | ✓ |
| MINISUBISHI | Lancer 1.3                    | (CJ1A, CK1A)       | 11/95 | 00    | ✓ |
| MINISUBISHI | Lancer 1.5                    | (CA2A, CB2A, CB3A) | 12/91 | 11/94 | ✓ |
| MINISUBISHI | Lancer 1.5                    | (CJ2A, CK2A)       | 11/95 | 00    | ✓ |
| MINISUBISHI | Lancer 1.6                    | (CA4A, CB4A)       | 12/91 | 11/94 | ✓ |
| MINISUBISHI | Lancer 1.6                    | (CJ4A, CK4A)       | 11/95 | 00    | ✓ |
| MINISUBISHI | Lancer 1.6                    | (CB4W)             | 93    | 00    | ✓ |
| MINISUBISHI | Lancer 1.8                    | (CA5A, CB5A)       | 12/91 | 11/94 | ✓ |
| MINISUBISHI | Lancer 2.0 Diesel             | (CB8A)             | 12/91 | 00    | ✓ |
| MINISUBISHI | Mirage 1.5                    | (CA2A, CB2A)       | 06/92 | 94    | ✓ |
| MINISUBISHI | Mirage 1.8                    | (CA5A)             | 06/92 | 94    | ✓ |
| MINISUBISHI | Mirage 1.8                    | (CB5A)             | 06/92 | 05/93 | ✓ |
| MINISUBISHI | Mirage 1.8                    | (CB5A)             | 06/93 | 94    | ✓ |
| MINISUBISHI | Pajero Pinin 1.8 GDI          | (H66W)             | 99    | 03    | ✓ |
| MINISUBISHI | Space Star 1.3 16V, 1.8 GDI   | (DG0)              | 98    | 04    | ✓ |
| MINISUBISHI | Space Star 1.6 16V, 1.9 DI-D  | (DG0)              | 01    | 04    | ✓ |
| PROTON      | Persona 1.3i                  | (C96)              | 93    | 98    | ✓ |
| PROTON      | Persona 1.5i                  | (C97)              | 93    | 98    | ✓ |
| PROTON      | Persona 1.6i 16V              | (C98)              | 93    | 98    | ✓ |
| PROTON      | Persona 1.8i                  | (C99)              | 95    | 98    | ✓ |
| PROTON      | Satria 1.3i                   | (C96)              | 94    | 98    | ✓ |
| PROTON      | Satria 1.6i 16V               | (C98)              | 94    | 98    | ✓ |
| PROTON      | Wira 1.3i                     | (C96)              | 93    | 98    | ✓ |
| PROTON      | Wira 1.5i                     | (C97)              | 93    | 98    | ✓ |
| PROTON      | Wira 1.6i 16V                 | (C98)              | 93    | 98    | ✓ |
| PROTON      | Wira 1.8i                     | (C99)              | 95    | 98    | ✓ |

**951 449**

|             |                     |         |       |       |   |
|-------------|---------------------|---------|-------|-------|---|
| HYUNDAI     | Sonata I 1.8i       | (BF2/3) | 10/88 | 93    | ✓ |
| HYUNDAI     | Sonata I 2.0i 16V   | (BF2/3) | 10/88 | 93    | ✓ |
| HYUNDAI     | Sonata I 2.4i       | (BF2/3) | 10/88 | 92    | ✓ |
| HYUNDAI     | Sonata I 3.0i       | (BF3)   | 91    | 93    | ✓ |
| MINISUBISHI | Space Wagon 2.0 4WD | (D08)   | 02/85 | 05/91 | ✓ |
| MINISUBISHI | Tredia 4WD          | (A215G) | 85    | 90    | ✓ |

**951 604**

|             |             |        |       |    |   |
|-------------|-------------|--------|-------|----|---|
| MINISUBISHI | Carisma 1.6 | (DA1A) | 02/99 | 05 | ✓ |
| MINISUBISHI | Carisma 1.8 | (DA2A) | 95    | 05 | ✓ |

**951 604**

|            |                                      |              |       |       |   |  |
|------------|--------------------------------------|--------------|-------|-------|---|--|
| MITSUBISHI | Carisma 1.9 TD                       | (DA4A)       | 02/99 | 00    | ✓ |  |
| MITSUBISHI | Carisma 1.9 DI-D                     | (DA5A)       | 00    | 05    | ✓ |  |
| MITSUBISHI | Eclipse 2.0i 16V                     | (D22A)       | 91    | 95    | ✓ |  |
| MITSUBISHI | Galant 1.8                           | (E32)        | 12/87 | 91    | ✓ |  |
| MITSUBISHI | Galant 1.8 Turbo Diesel              | (E34)        | 12/87 | 09/92 | ✓ |  |
| MITSUBISHI | Galant 2.0                           | (E15)        | 85    | 87    | ✓ |  |
| MITSUBISHI | Galant 2.0 GTI 16V                   | (E33)        | 88    | 92    | ✓ |  |
| MITSUBISHI | Galant 2.0 GTI 16V 4WD               | (E38, E39)   | 88    | 92    | ✓ |  |
| MITSUBISHI | Galant 2.4                           | (E16)        | 87    | 88    | ✓ |  |
| MITSUBISHI | Galant Sigma 2.0                     | (E15AK,E17A) | 10/86 | 04/94 | ✓ |  |
| MITSUBISHI | Lancer 1.6 4WD                       | (CD4W)       | 93    | 00    | ✓ |  |
| MITSUBISHI | Santamo 2.0 16V                      |              | 99    | 04    | ✓ |  |
| MITSUBISHI | Space Runner 1.8i 16V                | (N11W)       | 91    | 99    | ✓ |  |
| MITSUBISHI | Space Runner 1.8i 16V 4WD            | (N21W)       | 92    | 99    | ✓ |  |
| MITSUBISHI | Space Runner 2.0 16V                 | (N1/2_W)     | 97    | 99    | ✓ |  |
| MITSUBISHI | Space Runner 2.0 Turbo Diesel (N18W) |              | 96    | 99    | ✓ |  |
| MITSUBISHI | Space Wagon 1.8                      | (N31W)       | 06/91 | 10/98 | ✓ |  |
| MITSUBISHI | Space Wagon 1.8                      | (N35W)       | 05/91 | 10/98 | ✓ |  |
| MITSUBISHI | Space Wagon 1.8 4WD                  | (N41W)       | 05/91 | 05/92 | ✓ |  |
| MITSUBISHI | Space Wagon 1.8 Turbo Diesel (N38W)  |              | 10/91 | 10/98 | ✓ |  |
| MITSUBISHI | Space Wagon 2.0                      | (D08)        | 86    | 05/91 | ✓ |  |
| MITSUBISHI | Space Wagon 2.0                      | (N33W, N38W) | 06/92 | 10/98 | ✓ |  |
| MITSUBISHI | Space Wagon 2.0 Turbo Diesel (N38W)  |              | 06/92 | 10/98 | ✓ |  |
| MITSUBISHI | Space Wagon 2.0 4WD                  | (N43W)       | 06/91 | 10/98 | ✓ |  |
| MITSUBISHI | Space Wagon 2.4i                     | (N43W)       | 10/91 | 10/98 | ✓ |  |
| MITSUBISHI | Space Wagon 2.4 GDI                  | (N5_W)       | 10/98 | 02    | ✓ |  |
| MITSUBISHI | Space Wagon 2.4 GDI 4WD              | (N5_W)       | 10/98 | 02    | ✓ |  |

**951 606**

|            |                                    |                           |       |       |   |  |
|------------|------------------------------------|---------------------------|-------|-------|---|--|
| HYUNDAI    | Accent 1.3i                        |                           | 09/94 | 08/99 | ✓ |  |
| HYUNDAI    | Accent 1.5i                        |                           | 07/94 | 99    | ✓ |  |
| HYUNDAI    | Accent 1.5i 16V GT                 |                           | 10/95 | 99    | ✓ |  |
| HYUNDAI    | Atos 1.0i                          |                           | 97    | 04    | ✓ |  |
| HYUNDAI    | Atos Prime 1.0i                    |                           | 99    | 04    | ✓ |  |
| HYUNDAI    | Atos Prime 1.1i                    |                           | 06/03 | 04    | ✓ |  |
| HYUNDAI    | Elantra                            |                           | 90    | 99    | ✓ |  |
| HYUNDAI    | Excel 1.3                          |                           | 10/94 | 95    | ✓ |  |
| HYUNDAI    | Excel 1.5                          |                           | 12/85 | 08/93 | ✓ |  |
| HYUNDAI    | Excel 1.5                          |                           | 10/94 | 95    | ✓ |  |
| HYUNDAI    | Excel 1.6, 1.8                     |                           | 04/91 | 08/93 | ✓ |  |
| HYUNDAI    | Lantra I                           |                           | 90    | 95    | ✓ |  |
| HYUNDAI    | Pony II 1.3                        | (VD)                      | 07/91 | 95    | ✓ |  |
| HYUNDAI    | Pony II 1.5                        | (VD, VF, VA)              | 07/91 | 95    | ✓ |  |
| HYUNDAI    | S Coupé 1.5i                       |                           | 90    | 96    | ✓ |  |
| HYUNDAI    | Pony Pickup 1.5                    |                           | 86    | 88    | ✓ |  |
| MITSUBISHI | Colt 1.4 Turbo                     | (A15)                     | 82    | 84    | ✓ |  |
| MITSUBISHI | Colt                               | (C11, C12, C13, C14, C15) | 84    | 88    | ✓ |  |
| MITSUBISHI | Colt                               | (C51, C52, C53, C54, C58) | 04/88 | 91    | ✓ |  |
| MITSUBISHI | Cordia                             | (A212A)                   | 83    | 86    | ✓ |  |
| MITSUBISHI | Galant 1.6                         | (E31)                     | 12/87 | 91    | ✓ |  |
| MITSUBISHI | Galant Sigma 1.8                   | (E12A)                    | 87    | 96    | ✓ |  |
| MITSUBISHI | Lancer 1.3                         | (C61)                     | 04/88 | 12/91 | ✓ |  |
| MITSUBISHI | Lancer 1.5 12V                     | (C62, C72)                | 04/88 | 12/91 | ✓ |  |
| MITSUBISHI | Lancer 1.6                         | (C63, C73)                | 04/88 | 12/91 | ✓ |  |
| MITSUBISHI | Lancer 1.8 Diesel                  | (C64, C74)                | 04/88 | 12/91 | ✓ |  |
| MITSUBISHI | Lancer 1.8 4WD                     | (C37V, C77A)              | 04/88 | 94    | ✓ |  |
| MITSUBISHI | Lancer F 1.3                       | (C11)                     | 84    | 92    | ✓ |  |
| MITSUBISHI | Lancer F 1.4 Turbo                 | (A17)                     | 82    | 84    | ✓ |  |
| MITSUBISHI | Lancer F 1.5                       | (C12)                     | 84    | 92    | ✓ |  |
| MITSUBISHI | Lancer F 1.8                       | (C37)                     | 84    | 92    | ✓ |  |
| MITSUBISHI | Lancer F 1.8 Diesel                | (C14)                     | 84    | 92    | ✓ |  |
| MITSUBISHI | Mirage 1.5                         | (C12A)                    | 85    | 88    | ✓ |  |
| MITSUBISHI | Mirage 1.5                         | (C52A)                    | 04/88 | 05/91 | ✓ |  |
| MITSUBISHI | Mirage 1.6                         | (C13A)                    | 85    | 88    | ✓ |  |
| MITSUBISHI | Mirage 1.6                         | (C53A)                    | 04/88 | 05/91 | ✓ |  |
| MITSUBISHI | Space Wagon 1.8                    | (D04)                     | 06/86 | 05/91 | ✓ |  |
| MITSUBISHI | Space Wagon 1.8 Turbo Diesel (D09) |                           | 07/85 | 05/91 | ✓ |  |
| MITSUBISHI | Tredia                             | (A211A, A212A)            | 82    | 90    | ✓ |  |

**951 606**

|            |           |                       |    |    |   |  |
|------------|-----------|-----------------------|----|----|---|--|
| MITSUBISHI | Tredia    | (A213A, A214A, A215A) | 84 | 90 | ✓ |  |
| PROTON     | Saga 1.3i | (C21A)                | 86 | 93 | ✓ |  |
| PROTON     | Saga 1.5i | (C22A)                | 86 | 93 | ✓ |  |

**951 708**

|            |                          |                     |       |       |   |  |
|------------|--------------------------|---------------------|-------|-------|---|--|
| HYUNDAI    | Starex 2.4, 2.5 TD       |                     | 97    | 04    | ✓ |  |
| HYUNDAI    | H1 2.4i, 2.5 D, 2.5 TD   |                     | 10/97 | 04    | ✓ |  |
| HYUNDAI    | H100 2.4i, 2.5 D, 2.5 TD |                     | 07/93 | 00    | ✓ |  |
| HYUNDAI    | H150 2.5 Diesel          |                     | 07/97 | 00    | ✓ |  |
| MITSUBISHI | L 200 1.6                | (K01T, K11T)        | 86    | 06/96 | ✓ |  |
| MITSUBISHI | L 200 2.0                | (K02T, K12T)        | 86    | 06/96 | ✓ |  |
| MITSUBISHI | L 200 2.4                | (K15T)              | 86    | 06/96 | ✓ |  |
| MITSUBISHI | L 200 2.5 Diesel         | (K04T, K14T)        | 86    | 06/96 | ✓ |  |
| MITSUBISHI | L 200 2.6                | (K03T, K13T)        | 86    | 06/96 | ✓ |  |
| MITSUBISHI | L 300 1.6                | (L032P, P02V, P12V) | 11/86 | 06/96 | ✓ |  |
| MITSUBISHI | L 300 2.0                | (P03V, P03W, P13V)  | 11/86 | 06/96 | ✓ |  |
| MITSUBISHI | L 300 2.0                | (P03W, P15T)        | 06/96 | 00    | ✓ |  |
| MITSUBISHI | L 300 2.4                | (P04V, P04W, P14V)  | 11/86 | 06/96 | ✓ |  |
| MITSUBISHI | L 300 2.5 Diesel         | (L039P)             | 11/86 | 06/96 | ✓ |  |
| MITSUBISHI | L 300 2.5 Diesel         | (P05V, P05W, P15V)  | 11/86 | 06/96 | ✓ |  |
| MITSUBISHI | L 300 2.5 Diesel         | (P15T)              | 11/94 | 00    | ✓ |  |

**951 722**

|            |  |                    |       |       |   |  |
|------------|--|--------------------|-------|-------|---|--|
| HYUNDAI    | Galopper 2.5 Turbo Diesel, 3.0 V6 12V  |                    | 91    | 02    | ✓ |  |
| MITSUBISHI | Galopper 2.5 Turbo Diesel, 3.0i V6 12V |                    | 99    | 04    | ✓ |  |
| MITSUBISHI | Montero 3.0i V6                        | (V43W)             | 10/91 | 07/93 | ✓ |  |
| MITSUBISHI | Montero 3.5i V6                        | (V45W)             | 08/93 | 00    | ✓ |  |
| MITSUBISHI | Pajero I 2.3 Turbo Diesel              | (L042, L048)       | 83    | 11/90 | ✓ |  |
| MITSUBISHI | Pajero I 2.5                           | (L042, L047, L048) | 83    | 11/90 | ✓ |  |
| MITSUBISHI | Pajero I 2.5 Turbo Diesel              | (L044, L049)       | 87    | 11/90 | ✓ |  |
| MITSUBISHI | Pajero I 2.5 Turbo Diesel              | (L144, L149)       | 89    | 04/91 | ✓ |  |
| MITSUBISHI | Pajero I 2.6                           | (L042, L047, L048) | 83    | 11/90 | ✓ |  |
| MITSUBISHI | Pajero I 3.0i V6                       | (L141/6)           | 89    | 04/91 | ✓ |  |
| MITSUBISHI | Pajero II 1.8 GDI                      | (V2_W, V4_W)       | 98    | 04/00 | ✓ |  |
| MITSUBISHI | Pajero II 2.0 Diesel                   | (V26, V46)         | 07/93 | 04/00 | ✓ |  |
| MITSUBISHI | Pajero II 2.4                          | (V2_W, V4_W)       | 91    | 04/00 | ✓ |  |
| MITSUBISHI | Pajero II 2.5 Turbo Diesel             | (V24, V44)         | 91    | 04/94 | ✓ |  |
| MITSUBISHI | Pajero II 2.5 Turbo D.                 | (V2_W, V4_W)       | 91    | 04/03 | ✓ |  |
| MITSUBISHI | Pajero II 2.8 Turbo D.                 | (V2_W, V4_W)       | 94    | 04/00 | ✓ |  |
| MITSUBISHI | Pajero II 3.0i V6                      | (V23, V43)         | 91    | 95    | ✓ |  |
| MITSUBISHI | Pajero II 3.0i V6 24V                  | (V23, V43)         | 94    | 04/00 | ✓ |  |
| MITSUBISHI | Pajero II 3.5i V6 24V                  | (V25, V45)         | 07/93 | 04/00 | ✓ |  |
| MITSUBISHI | Pajero Classic 2.5 Turbo Diesel        | (V2_W)             | 02    | 04/05 | ✓ |  |
| MITSUBISHI | Pajero Sport 2.5 Turbo Diesel          | (K94W)             | 12/98 | 02    | ✓ |  |
| MITSUBISHI | Pajero Sport 3.0i V6 24V               | (K96W)             | 12/98 | 02    | ✓ |  |
| MITSUBISHI | L 200 4WD 2.0                          | (K22T, K32T)       | 86    | 06/96 | ✓ |  |
| MITSUBISHI | L 200 4WD 2.4                          | (K35T)             | 06/93 | 06/96 | ✓ |  |
| MITSUBISHI | L 200 4WD 2.5 Diesel                   | (K24T, K34T)       | 86    | 06/96 | ✓ |  |
| MITSUBISHI | L 300 4WD 1.8                          | (L035)             | 11/86 | 10/96 | ✓ |  |
| MITSUBISHI | L 300 4WD 2.0                          | (L037, P23V/W)     | 11/86 | 06/96 | ✓ |  |
| MITSUBISHI | L 300 4WD 2.4                          | (P24V, P24W)       | 11/86 | 06/96 | ✓ |  |
| MITSUBISHI | L 300 4WD 2.5 Diesel                   | (P25V/W, P45V)     | 11/86 | 06/96 | ✓ |  |

**951 756**

|            |                          |              |       |       |   |   |
|------------|--------------------------|--------------|-------|-------|---|---|
| MITSUBISHI | 3000 GT 4WD / 4WS        | (Z16A)       | 92    | 00    | ✓ |   |
| MITSUBISHI | Galant 2.0               | (A12, A16)   | 78    | 84    | ✓ |   |
| MITSUBISHI | Galant 2.3 Turbo Diesel  | (A16)        | 78    | 84    | ✓ |   |
| MITSUBISHI | Galant Sapporo 2.0       | (A123A)      | 79    | 84    | ✓ |   |
| MITSUBISHI | Galant Sapporo 2.0 Turbo | (A123A)      | 79    | 84    | ✓ |   |
| MITSUBISHI | Galant Sigma 2.0         | (A123V)      | 79    | 84    | ✓ |   |
| MITSUBISHI | Galant Sigma 2.0         | (E15AK,E17A) | 10/86 | 04/94 | ✓ | ✓ |
| MITSUBISHI | Lancer 2.0 Turbo         | (A17)        | 80    | 84    | ✓ |   |
| MITSUBISHI | Starion 2.0i Turbo       | (A183)       | 82    | 90    | ✓ |   |
| MITSUBISHI | Starion 2.6i Turbo       | (A187)       | 86    | 90    | ✓ |   |

**951 833**

|            |                                  |        |       |    |   |  |
|------------|----------------------------------|--------|-------|----|---|--|
| MITSUBISHI | Pajero III 3.2 DI-D, 3.5i V6 24V | (V60)  | 04/00 | 04 | ✓ |  |
| MITSUBISHI | Pajero Classic 3.2 DI-D          | (V2_W) | 05/05 | 06 | ✓ |  |

**951 962**

|         |                               |       |       |   |  |
|---------|-------------------------------|-------|-------|---|--|
| HYUNDAI | Accent 1.3i, 1.5i             | 00    | 05    | ✓ |  |
| HYUNDAI | Accent 1.5 CRDi               | 01    | 05    | ✓ |  |
| HYUNDAI | Accent 1.6                    | 02    | 05    | ✓ |  |
| HYUNDAI | Avante                        | 96    | 99    | ✓ |  |
| HYUNDAI | Coupe 1.6 16V, 2.0 16V (RD)   | 96    | 04/02 | ✓ |  |
| HYUNDAI | Getz                          | 09/02 | 04    | ✓ |  |
| HYUNDAI | Lantra II 1.5 12V, 1.6 16V    | 05/95 | 03    | ✓ |  |
| HYUNDAI | Lantra II 1.8 16V, 1.8 16V GT | 05/95 | 03    | ✓ |  |
| HYUNDAI | Lantra II 1.9 D               | 98    | 03    | ✓ |  |
| HYUNDAI | Lantra II 2.0 16V             | 05/95 | 03    | ✓ |  |
| KIA     | Picanto                       | 04    | 05    | ✓ |  |

**951 971**

|            |                           |    |    |   |  |
|------------|---------------------------|----|----|---|--|
| mitsubishi | Sigma 3.0 V6 (F16A, F07W) | 90 | 96 | ✓ |  |
|------------|---------------------------|----|----|---|--|

**952 279**

|            |                          |       |    |   |  |
|------------|--------------------------|-------|----|---|--|
| mitsubishi | Lancer 1.6 (CB4W)        | 93    | 00 | ✓ |  |
| mitsubishi | Lancer 2.0 Diesel (CB8A) | 12/91 | 00 | ✓ |  |

**952 297**

|            |                                      |       |    |   |  |
|------------|--------------------------------------|-------|----|---|--|
| mitsubishi | Pajero Sport 2.5 Turbo Diesel (K94W) | 12/98 | 02 | ✓ |  |
| mitsubishi | Pajero Sport 3.0i V6 24V (K96W)      | 12/98 | 02 | ✓ |  |
| mitsubishi | Space Gear 2.0 16V (PA/B3V/W)        | 95    | 00 | ✓ |  |
| mitsubishi | Space Gear 2.4i (PA4W)               | 95    | 00 | ✓ |  |
| mitsubishi | Space Gear 2.5 Turbo D. (PA/B5V/W)   | 95    | 00 | ✓ |  |
| mitsubishi | Space Gear 2.5 T.D. 4WD (PD5V/W)     | 95    | 00 | ✓ |  |
| mitsubishi | L 200 2.5 Diesel (K64T)              | 97    | 02 | ✓ |  |
| mitsubishi | L 200 2.5 Turbo Diesel (K74T)        | 01    | 02 | ✓ |  |
| mitsubishi | L 200 4WD 2.5 Turbo Diesel (K74T)    | 97    | 02 | ✓ |  |

**952 405**

|            |                                     |       |       |   |  |
|------------|-------------------------------------|-------|-------|---|--|
| mitsubishi | Carisma 1.6, 1.9 TD (DA1A)          | 95    | 02/99 | ✓ |  |
| mitsubishi | Colt 1.1                            | 10/04 | 12/06 | ✓ |  |
| mitsubishi | Colt 1.3i (CA1A, CB1A)              | 12/91 | 11/95 | ✓ |  |
| mitsubishi | Colt 1.3i 16V (CJ1A, CK1A)          | 11/95 | 05/03 | ✓ |  |
| mitsubishi | Colt 1.3                            | 06/04 | 12/06 | ✓ |  |
| mitsubishi | Colt 1.5 (CA2A, CB2A, CB3A)         | 12/91 | 11/95 | ✓ |  |
| mitsubishi | Colt 1.5 (CJ2A, CK2A)               | 11/95 | 05/03 | ✓ |  |
| mitsubishi | Colt 1.5                            | 06/04 | 12/06 | ✓ |  |
| mitsubishi | Colt 1.6i 16V (CA4A, CB4A)          | 12/91 | 11/95 | ✓ |  |
| mitsubishi | Colt 1.6i 16V (CJ4A, CK4A)          | 11/95 | 05/03 | ✓ |  |
| mitsubishi | Colt 1.8 GTI 16V (CA5A, CB5A)       | 12/91 | 11/95 | ✓ |  |
| mitsubishi | Colt 1.8 Diesel, 2.0 Diesel (CB8A)  | 12/91 | 11/95 | ✓ |  |
| mitsubishi | Colt Cabriolet 1.5, 1.5 Turbo (CZC) | 05/06 | 12/06 | ✓ |  |
| mitsubishi | Lancer 1.3 (CA1A, CB1A)             | 12/91 | 11/94 | ✓ |  |
| mitsubishi | Lancer 1.3 (CJ1A, CK1A)             | 11/95 | 00    | ✓ |  |
| mitsubishi | Lancer 1.5 (CA2A, CB2A, CB3A)       | 12/91 | 11/94 | ✓ |  |
| mitsubishi | Lancer 1.5 (CJ2A, CK2A)             | 11/95 | 00    | ✓ |  |
| mitsubishi | Lancer 1.6 (CA4A, CB4A)             | 12/91 | 11/94 | ✓ |  |
| mitsubishi | Lancer 1.6 (CJ4A, CK4A)             | 11/95 | 00    | ✓ |  |
| mitsubishi | Lancer 1.8 (CA5A, CB5A)             | 12/91 | 11/94 | ✓ |  |
| mitsubishi | Lancer 2.0 Diesel (CB8A)            | 12/91 | 00    | ✓ |  |
| mitsubishi | Mirage 1.5 (CA2A, CB2A)             | 06/92 | 94    | ✓ |  |
| mitsubishi | Mirage 1.8 (CA5A, CB5A)             | 06/92 | 94    | ✓ |  |
| PROTON     | Persona 1.3i (C96)                  | 93    | 98    | ✓ |  |
| PROTON     | Persona 1.5i (C97)                  | 93    | 98    | ✓ |  |
| PROTON     | Persona 1.6i 16V (C98)              | 93    | 98    | ✓ |  |
| PROTON     | Satria 1.3i (C96)                   | 94    | 98    | ✓ |  |
| PROTON     | Satria 1.6i 16V (C98)               | 94    | 98    | ✓ |  |
| PROTON     | Wira 1.3i (C96)                     | 93    | 98    | ✓ |  |
| PROTON     | Wira 1.5i (C97)                     | 93    | 98    | ✓ |  |
| PROTON     | Wira 1.6i 16V (C98)                 | 93    | 98    | ✓ |  |

**952 415**

|            |                                     |       |       |   |  |
|------------|-------------------------------------|-------|-------|---|--|
| mitsubishi | Space Wagon 1.8 (N31W)              | 06/91 | 10/98 | ✓ |  |
| mitsubishi | Space Wagon 1.8 (N35W)              | 05/91 | 10/98 | ✓ |  |
| mitsubishi | Space Wagon 1.8 Turbo Diesel (N38W) | 10/91 | 10/98 | ✓ |  |
| mitsubishi | Space Wagon 2.0 (D08)               | 86    | 05/91 | ✓ |  |
| mitsubishi | Space Wagon 2.0 (N33W, N38W)        | 06/92 | 10/98 | ✓ |  |

**952 415**

|            |                                     |       |       |   |  |
|------------|-------------------------------------|-------|-------|---|--|
| mitsubishi | Space Wagon 2.0 Turbo Diesel (N38W) | 06/92 | 10/98 | ✓ |  |
| mitsubishi | Space Wagon 2.4i (N43W)             | 10/91 | 10/98 | ✓ |  |

**952 417**

|            |                                     |       |       |   |  |
|------------|-------------------------------------|-------|-------|---|--|
| mitsubishi | Carisma 1.6 (DA1A)                  | 02/99 | 05    | ✓ |  |
| mitsubishi | Carisma 1.8 (DA2A)                  | 95    | 05    | ✓ |  |
| mitsubishi | Carisma 1.9 TD (DA4A)               | 02/99 | 00    | ✓ |  |
| mitsubishi | Carisma 1.9 DI-D (DA5A)             | 00    | 05    | ✓ |  |
| mitsubishi | Space Wagon 1.8 (N31W)              | 06/92 | 10/98 | ✓ |  |
| mitsubishi | Space Wagon 1.8 (N35W)              | 05/91 | 10/98 | ✓ |  |
| mitsubishi | Space Wagon 1.8 Turbo Diesel (N38W) | 10/91 | 10/98 | ✓ |  |
| mitsubishi | Space Wagon 2.0 (N33W, N38W)        | 06/92 | 10/98 | ✓ |  |
| mitsubishi | Space Wagon 2.0 Turbo Diesel (N38W) | 06/92 | 10/98 | ✓ |  |
| mitsubishi | Space Wagon 2.4i (N43W)             | 10/91 | 10/98 | ✓ |  |

**952 551**

|            |                        |       |       |   |  |
|------------|------------------------|-------|-------|---|--|
| mitsubishi | Carisma 1.6 (DA1A)     | 95    | 02/99 | ✓ |  |
| mitsubishi | Carisma 1.9 TD (DA4A)  | 95    | 02/99 | ✓ |  |
| mitsubishi | Colt 1.5 (CB3A)        | 12/91 | 11/95 | ✓ |  |
| mitsubishi | Lancer 1.5 (CB3A)      | 12/91 | 11/94 | ✓ |  |
| mitsubishi | Mirage 1.8 (CB5A)      | 06/92 | 05/93 | ✓ |  |
| mitsubishi | Mirage 1.8 (CB5A)      | 06/93 | 94    | ✓ |  |
| PROTON     | Persona 1.6i 16V (C98) | 93    | 98    | ✓ |  |
| PROTON     | Persona 1.8i (C99)     | 95    | 98    | ✓ |  |
| PROTON     | Wira 1.6i 16V (C98)    | 93    | 98    | ✓ |  |
| PROTON     | Wira 1.8i (C99)        | 95    | 98    | ✓ |  |

**952 608**

|            |                          |       |    |   |  |
|------------|--------------------------|-------|----|---|--|
| mitsubishi | Galant 1.8 (E32)         | 10/89 | 91 | ✓ |  |
| mitsubishi | Galant 2.0 GTI 16V (E33) | 88    | 92 | ✓ |  |

**952 661**

|            |  |       |       |   |  |
|------------|--|-------|-------|---|--|
| mitsubishi | Pajero I 2.3 Turbo Diesel (L042, L048) | 83    | 11/90 | ✓ |  |
| mitsubishi | Pajero I 2.5 (L042, L047, L048)        | 83    | 11/90 | ✓ |  |
| mitsubishi | Pajero I 2.5 Turbo Diesel (L044, L049) | 87    | 11/90 | ✓ |  |
| mitsubishi | Pajero I 2.5 Turbo Diesel (L144, L149) | 89    | 04/91 | ✓ |  |
| mitsubishi | Pajero I 2.6 (L042, L047, L048)        | 83    | 11/90 | ✓ |  |
| mitsubishi | Pajero I 3.0i V6 (L141/6)              | 89    | 04/91 | ✓ |  |
| mitsubishi | L 200 1.6 (K01T, K11T)                 | 86    | 06/90 | ✓ |  |
| mitsubishi | L 200 2.0 (K02T, K12T)                 | 86    | 06/90 | ✓ |  |
| mitsubishi | L 200 2.4 (K15T)                       | 86    | 06/90 | ✓ |  |
| mitsubishi | L 200 2.5 Diesel (K04T, K14T)          | 86    | 06/90 | ✓ |  |
| mitsubishi | L 200 2.6 (K03T, K13T)                 | 86    | 06/90 | ✓ |  |
| mitsubishi | L 200 4WD 2.0 (K22T, K32T)             | 86    | 06/90 | ✓ |  |
| mitsubishi | L 200 4WD 2.5 Diesel (K24T, K34T)      | 86    | 06/90 | ✓ |  |
| mitsubishi | L 300 2.0 (P03W, P15T)                 | 06/96 | 00    | ✓ |  |
| mitsubishi | L 300 2.5 Diesel (P15T)                | 11/94 | 00    | ✓ |  |
| mitsubishi | L 300 4WD 1.8 (L035)                   | 11/86 | 10/90 | ✓ |  |
| mitsubishi | L 300 4WD 1.8 (L035)                   | 11/90 | 06/96 | ✓ |  |
| mitsubishi | L 300 4WD 2.0 (L037, P23V/W)           | 11/86 | 10/90 | ✓ |  |
| mitsubishi | L 300 4WD 2.4 (P24V, P24W)             | 11/86 | 10/90 | ✓ |  |
| mitsubishi | L 300 4WD 2.5 Diesel (P25V/W, P45V)    | 11/86 | 10/90 | ✓ |  |
| mitsubishi | L 400 2.5 Turbo Diesel (PA5W/V)        | 95    | 02    | ✓ |  |

**952 676**

|            |                       |       |       |   |  |
|------------|-----------------------|-------|-------|---|--|
| mitsubishi | Colt (C53, C58)       | 04/88 | 91    | ✓ |  |
| mitsubishi | Lancer 1.6 (C63, C73) | 04/88 | 12/91 | ✓ |  |
| mitsubishi | Mirage 1.6 (C53A)     | 04/88 | 05/91 | ✓ |  |

**952 678**

|            |                              |       |       |   |  |
|------------|------------------------------|-------|-------|---|--|
| mitsubishi | Colt (C51, C52, C54)         | 04/88 | 91    | ✓ |  |
| mitsubishi | Lancer 1.3 (C61)             | 04/88 | 12/91 | ✓ |  |
| mitsubishi | Lancer 1.5 12V (C62, C72)    | 04/88 | 12/91 | ✓ |  |
| mitsubishi | Lancer 1.8 Diesel (C64, C74) | 04/88 | 12/91 | ✓ |  |
| mitsubishi | Mirage 1.5 (C52A)            | 04/88 | 05/91 | ✓ |  |

**952 679**

|            |                           |    |    |   |  |
|------------|---------------------------|----|----|---|--|
| mitsubishi | Starion 2.0i Turbo (A183) | 82 | 90 | ✓ |  |
|------------|---------------------------|----|----|---|--|



**952 710**

|            |                                |    |    |   |
|------------|--------------------------------|----|----|---|
| mitsubishi | Colt (C11, C12, C13, C14, C15) | 84 | 88 | ✓ |
| mitsubishi | Lancer F 1.3 (C11)             | 84 | 92 | ✓ |
| mitsubishi | Lancer F 1.5 (C12)             | 84 | 92 | ✓ |
| mitsubishi | Lancer F 1.8 (C37)             | 84 | 92 | ✓ |
| mitsubishi | Lancer F 1.8 Diesel (C14)      | 84 | 92 | ✓ |
| mitsubishi | Mirage 1.5 (C12A)              | 85 | 88 | ✓ |
| mitsubishi | Mirage 1.6 (C13A)              | 85 | 88 | ✓ |
| PROTON     | Saga 1.3i (C21A)               | 86 | 93 | ✓ |
| PROTON     | Saga 1.5i (C22A)               | 86 | 93 | ✓ |

**952 758**

|            |                                     |       |       |   |
|------------|-------------------------------------|-------|-------|---|
| mitsubishi | Space Gear 2.0 16V (PA/B3V/W)       | 95    | 00    | ✓ |
| mitsubishi | Space Gear 2.4i (PA4W)              | 95    | 00    | ✓ |
| mitsubishi | Space Gear 2.5 Turbo D. (PA/B5V/W)  | 95    | 00    | ✓ |
| mitsubishi | L 300 1.6 (L032P, P02V, P12V)       | 11/86 | 10/90 | ✓ |
| mitsubishi | L 300 2.0 (P03V, P03W, P13V)        | 11/86 | 10/90 | ✓ |
| mitsubishi | L 300 2.4 (P04V, P04W, P14V)        | 11/86 | 10/90 | ✓ |
| mitsubishi | L 300 2.5 Diesel (L039P)            | 11/86 | 10/90 | ✓ |
| mitsubishi | L 300 2.5 Diesel (P05V, P05W, P15V) | 11/86 | 10/90 | ✓ |

**952 769**

|            |  |       |       |   |
|------------|--|-------|-------|---|
| mitsubishi | Montero 3.0i V6 (V43W)                 | 10/91 | 07/93 | ✓ |
| mitsubishi | Montero 3.5i V6 (V45W)                 | 08/93 | 00    | ✓ |
| mitsubishi | Pajero II 1.8 GDI (V2_W, V4_W)         | 98    | 04/00 | ✓ |
| mitsubishi | Pajero II 2.0 Diesel (V26, V46)        | 07/93 | 04/00 | ✓ |
| mitsubishi | Pajero II 2.4 (V2_W, V4_W)             | 91    | 04/00 | ✓ |
| mitsubishi | Pajero II 2.5 Turbo Diesel (V24, V44)  | 91    | 04/94 | ✓ |
| mitsubishi | Pajero II 2.5 Turbo D. (V2_W, V4_W)    | 91    | 04/03 | ✓ |
| mitsubishi | Pajero II 2.8 Turbo D. (V2_W, V4_W)    | 94    | 04/00 | ✓ |
| mitsubishi | Pajero II 3.0i V6 (V23, V43)           | 91    | 95    | ✓ |
| mitsubishi | Pajero II 3.0i V6 24V (V23, V43)       | 94    | 04/00 | ✓ |
| mitsubishi | Pajero II 3.5i V6 24V (V25, V45)       | 07/93 | 04/00 | ✓ |
| mitsubishi | Pajero Classic 2.5 Turbo Diesel (V2_W) | 02    | 04/05 | ✓ |

**952 832**

|            |                  |    |    |   |
|------------|------------------|----|----|---|
| mitsubishi | Lancer 1.2 (A17) | 75 | 84 | ✓ |
| mitsubishi | Lancer 1.4 (A72) | 75 | 79 | ✓ |

**952 935**

|            |                                     |       |       |   |
|------------|-------------------------------------|-------|-------|---|
| mitsubishi | L 300 1.6 (L032P, P02V, P12V)       | 11/90 | 06/96 | ✓ |
| mitsubishi | L 300 2.0 (P03V, P03W, P13V)        | 11/90 | 06/96 | ✓ |
| mitsubishi | L 300 2.4 (P04V, P04W, P14V)        | 11/90 | 06/96 | ✓ |
| mitsubishi | L 300 2.5 Diesel (L039P)            | 11/90 | 06/96 | ✓ |
| mitsubishi | L 300 2.5 Diesel (P05V, P05W, P15V) | 11/90 | 06/96 | ✓ |

**952 936**

|            |                                     |       |       |   |
|------------|-------------------------------------|-------|-------|---|
| mitsubishi | L 200 1.6 (K01T, K11T)              | 07/90 | 06/96 | ✓ |
| mitsubishi | L 200 2.0 (K02T, K12T)              | 07/90 | 06/96 | ✓ |
| mitsubishi | L 200 2.4 (K15T)                    | 07/90 | 06/96 | ✓ |
| mitsubishi | L 200 2.5 Diesel (K04T, K14T)       | 07/90 | 06/96 | ✓ |
| mitsubishi | L 200 2.6 (K03T, K13T)              | 07/90 | 06/96 | ✓ |
| mitsubishi | L 200 4WD 2.0 (K22T, K32T)          | 07/90 | 06/96 | ✓ |
| mitsubishi | L 200 4WD 2.4 (K35T)                | 06/93 | 06/96 | ✓ |
| mitsubishi | L 200 4WD 2.5 Diesel (K24T, K34T)   | 07/90 | 06/96 | ✓ |
| mitsubishi | L 300 4WD 2.0 (L037, P23V/W)        | 11/90 | 06/96 | ✓ |
| mitsubishi | L 300 4WD 2.4 (P24V, P24W)          | 11/90 | 06/96 | ✓ |
| mitsubishi | L 300 4WD 2.5 Diesel (P25V/W, P45V) | 11/90 | 06/96 | ✓ |

**952 993**

|            |                                   |       |       |   |
|------------|-----------------------------------|-------|-------|---|
| mitsubishi | 3000 GT 4WD / 4WS (Z16A)          | 92    | 00    | ✓ |
| mitsubishi | Galant 2.0 GTI 16V 4WD (E38, E39) | 88    | 92    | ✓ |
| mitsubishi | Space Wagon 2.0 4WD (D08)         | 02/85 | 05/91 | ✓ |
| mitsubishi | Space Wagon 2.0 4WD (N43W)        | 06/91 | 10/98 | ✓ |
| mitsubishi | Tredia 4WD (A215G)                | 85    | 90    | ✓ |

**952 994**

|            |                                      |    |    |   |
|------------|--------------------------------------|----|----|---|
| mitsubishi | Space Runner 1.8i 16V (N11W)         | 91 | 99 | ✓ |
| mitsubishi | Space Runner 2.0 16V (N1/2_W)        | 97 | 99 | ✓ |
| mitsubishi | Space Runner 2.0 Turbo Diesel (N18W) | 96 | 99 | ✓ |

**952 995**

|            |                           |    |    |   |
|------------|---------------------------|----|----|---|
| mitsubishi | Eclipse 2.0i 16V (D22A)   | 91 | 95 | ✓ |
| mitsubishi | Sigma 3.0 V6 (F16A, F07W) | 90 | 96 | ✓ |

**952 996**

|            |                       |    |    |   |
|------------|-----------------------|----|----|---|
| mitsubishi | Lancer 1.6 4WD (CD4W) | 93 | 00 | ✓ |
|------------|-----------------------|----|----|---|

**952 997**

|            |                         |    |    |   |
|------------|-------------------------|----|----|---|
| mitsubishi | Eclipse 2.0i 16V (D32A) | 95 | 00 | ✓ |
|------------|-------------------------|----|----|---|

**960 578**

|        |                                     |    |    |   |
|--------|-------------------------------------|----|----|---|
| NISSAN | Pulsar 1.3, 1.4, 1.6 (B12, N13)     | 86 | 90 | ✓ |
| NISSAN | Pulsar 1.6i 16V DOHC (B12, N13)     | 86 | 90 | ✓ |
| NISSAN | Pulsar 1.7 Diesel (B12, N13)        | 86 | 90 | ✓ |
| NISSAN | Pulsar 1.8i 16V DOHC (B12, N13)     | 86 | 90 | ✓ |
| NISSAN | Pulsar 4WD (N13, B12)               | 86 | 90 | ✓ |
| NISSAN | Sunny 1.3, 1.4, 1.5, 1.6 (B12, N13) | 86 | 89 | ✓ |
| NISSAN | Sunny 1.6i 16V GTI (B12, N13)       | 86 | 90 | ✓ |
| NISSAN | Sunny 1.7 Diesel (B12, N13)         | 86 | 90 | ✓ |
| NISSAN | Sunny 1.8i 16V GTI (B12, N13)       | 86 | 90 | ✓ |
| NISSAN | Sunny 4WD 1.6 (B12, N13)            | 86 | 90 | ✓ |

**960 638**

|        |                                    |       |       |   |
|--------|------------------------------------|-------|-------|---|
| NISSAN | Bluebird (U12)                     | 07/89 | 90    | ✓ |
| NISSAN | Bluebird 2.4 (U13)                 | 06/92 | 05/93 | ✓ |
| NISSAN | Maxima I 3.0i V6 12V (J30)         | 12/88 | 06/94 | ✓ |
| NISSAN | Maxima II 2.0i V6 24V (A32)        | 07/94 | 08/00 | ✓ |
| NISSAN | Maxima II 2.5i V6 24V (A32)        | 07/94 | 08/00 | ✓ |
| NISSAN | Maxima II 3.0i V6 24V (A32)        | 07/94 | 08/00 | ✓ |
| NISSAN | Prairie Pro 2.0i (M11)             | 10/88 | 94    | ✓ |
| NISSAN | Prairie Pro 2.0i 4WD (M11)         | 10/88 | 94    | ✓ |
| NISSAN | Prairie Pro 2.4i (M11)             | 92    | 94    | ✓ |
| NISSAN | Prairie Pro 2.4i 4WD (M11)         | 92    | 94    | ✓ |
| NISSAN | Primera 1.6i 16V, 2.0i 16V (P10E)  | 06/90 | 06/96 | ✓ |
| NISSAN | Primera 1.6i 16V, 1.8i 16V (P11E)  | 07/96 | 02    | ✓ |
| NISSAN | Primera 2.0i 16V (P11E)            | 07/96 | 02    | ✓ |
| NISSAN | Primera 2.0 Diesel (P10E)          | 06/90 | 06/96 | ✓ |
| NISSAN | Primera 2.0 Turbo Diesel (P11E)    | 07/96 | 02    | ✓ |
| NISSAN | Primera 4WD (P10E)                 | 04/91 | 09/94 | ✓ |
| NISSAN | Primera Wagon 1.6i 16V (WP11E)     | 98    | 02    | ✓ |
| NISSAN | Primera Wagon 2.0i 16V (WP11E)     | 98    | 02    | ✓ |
| NISSAN | Primera Wagon 2.0 Turbo D. (WP11E) | 98    | 02    | ✓ |

**960 702**

|        |                                |       |       |   |
|--------|--------------------------------|-------|-------|---|
| NISSAN | Prairie 2.0i 4WD (M10)         | 86    | 06/88 | ✓ |
| NISSAN | Primera Wagon 1.6i 16V (W10)   | 06/90 | 97    | ✓ |
| NISSAN | Primera Wagon 2.0i 16V (W10)   | 06/90 | 97    | ✓ |
| NISSAN | Primera Wagon 2.0 Diesel (W10) | 06/90 | 97    | ✓ |
| NISSAN | Pulsar 4WD (N13)               | 86    | 90    | ✓ |
| NISSAN | Sentra 4WD (B12)               | 86    | 90    | ✓ |
| NISSAN | Sunny 4WD 1.6 (B12, N13)       | 86    | 90    | ✓ |

**961 229**

|        |  |       |    |   |
|--------|--|-------|----|---|
| NISSAN | Almera II 1.5 16V, 1.8 16V, 2.2 Di (N16) | 01/00 | 04 | ✓ |
| NISSAN | Almera II 1.5 dCi (N16)                  | 01/03 | 04 | ✓ |
| NISSAN | Almera II 2.2 dCi (N16)                  | 09/03 | 04 | ✓ |

**961 411**

|        |                                    |       |       |   |
|--------|------------------------------------|-------|-------|---|
| NISSAN | Patrol GR I 2.8 Turbo D. (Y60)     | 08/88 | 05/97 | ✓ |
| NISSAN | Patrol GR I 2.8 Turbo D. 4WD (Y60) | 08/88 | 05/97 | ✓ |
| NISSAN | Patrol GR I 4.2i 4WD (Y60)         | 10/91 | 05/97 | ✓ |
| NISSAN | Patrol GR I 4.2 Diesel 4WD (Y60)   | 10/91 | 05/97 | ✓ |
| NISSAN | Patrol GR I 4.2 Turbo D. 4WD (Y60) | 10/91 | 05/97 | ✓ |
| NISSAN | Safari 2.8 Turbo D. 2WD, 4WD (Y60) | 08/88 | 01/94 | ✓ |
| NISSAN | Safari 4.2 KAT 4WD (Y60)           | 10/91 | 01/94 | ✓ |
| NISSAN | Safari 4.2 Diesel 4WD (Y60)        | 10/91 | 01/94 | ✓ |

**961 479**

|        |                                      |    |       |   |
|--------|--------------------------------------|----|-------|---|
| NISSAN | March 1.0i 16V, Micra 1.0i 16V (K11) | 92 | 02/03 | ✓ |
| NISSAN | March 1.3i 16V, Micra 1.3i 16V (K11) | 92 | 10/00 | ✓ |

**961 479**

|        |   |       |       |   |  |
|--------|---|-------|-------|---|--|
| NISSAN | March 1.4i 16V, Micra 1.4i 16V (K11)    | 10/00 | 02/03 | ✓ |  |
| NISSAN | March 1.5 Diesel, Micra 1.5 Diesel(K11) | 98    | 02/03 | ✓ |  |

**961 503**

|        |                   |    |    |   |  |
|--------|-------------------|----|----|---|--|
| NISSAN | 280 ZX 2.7 (S130) | 79 | 84 | ✓ |  |
| NISSAN | Silvia            | 80 | 83 | ✓ |  |

**961 576**

|        |                                |       |       |   |  |
|--------|--------------------------------|-------|-------|---|--|
| NISSAN | Bluebird, Bluebird Turbo (U11) | 11/83 | 90    | ✓ |  |
| NISSAN | Bluebird, Bluebird Turbo (T12) | 12/85 | 89    | ✓ |  |
| NISSAN | Bluebird (T12)                 | 90    | 02/92 | ✓ |  |
| NISSAN | Liberta, Liberta Turbo (T12)   | 12/85 | 89    | ✓ |  |
| NISSAN | Stanza, Stanza Turbo (T12)     | 12/85 | 89    | ✓ |  |
| NISSAN | Stanza (T12)                   | 90    | 92    | ✓ |  |

**961 610**

|        |                                      |       |    |   |  |
|--------|--------------------------------------|-------|----|---|--|
| NISSAN | March 1.0, 1.2, Micra 1.0, 1.2 (K10) | 11/88 | 92 | ✓ |  |
|--------|--------------------------------------|-------|----|---|--|

**961 648**

|        |  |       |       |   |   |
|--------|--|-------|-------|---|---|
| NISSAN | 100 NX 1.6i 16V, 2.0i 16V GTI (B13)    | 10/91 | 98    | ✓ |   |
| NISSAN | Almera I 1.4i 16V, 1.6i 16V (N15)      | 07/95 | 07/00 | ✓ |   |
| NISSAN | Almera I 2.0i 16V GTI (N15)            | 07/95 | 07/00 | ✓ |   |
| NISSAN | Almera I 2.0 Diesel (N15)              | 07/95 | 07/00 | ✓ |   |
| NISSAN | Presea 1.5i, 2.0i (R10)                | 05/91 | 96    | ✓ |   |
| NISSAN | Pulsar 1.4, 1.6, 2.0 (N14)             | 10/90 | 00    | ✓ |   |
| NISSAN | Pulsar 4WD (N14)                       | 10/90 | 03/93 | ✓ | ✓ |
| NISSAN | Sentra 1.3, 1.4, 1.5, 2.0 Diesel (B14) | 01/94 | 09/98 | ✓ |   |
| NISSAN | Sentra 1.6 (B13)                       | 09/90 | 09/98 | ✓ |   |
| NISSAN | Sentra 2.0 (B13)                       | 09/90 | 12/93 | ✓ |   |
| NISSAN | Sunny 1.3, 1.4i 16V, 1.5 (B14)         | 04/94 | 96    | ✓ |   |
| NISSAN | Sunny 1.4i 16V, 1.6i 16V (N14)         | 10/90 | 96    | ✓ |   |
| NISSAN | Sunny 1.6, 2.0 (B13)                   | 09/90 | 10/94 | ✓ |   |
| NISSAN | Sunny 1.6i 16V (B14)                   | 04/94 | 96    | ✓ |   |
| NISSAN | Sunny 2.0i 16V, 2.0i 16V GTI (N14)     | 10/90 | 96    | ✓ |   |
| NISSAN | Sunny 2.0 Diesel (B14)                 | 04/94 | 96    | ✓ |   |
| NISSAN | Sunny 2.0 Diesel (N14)                 | 10/90 | 96    | ✓ |   |
| NISSAN | Sunny 4WD 1.6 16V (N14)                | 10/90 | 96    | ✓ | ✓ |
| NISSAN | Sunny 4WD 2.0i 16V GT R (N14)          | 10/90 | 96    | ✓ | ✓ |
| NISSAN | Sunny Wagon (Y10)                      | 11/90 | 96    | ✓ |   |

**961 677**

|        |             |       |       |   |  |
|--------|-------------|-------|-------|---|--|
| NISSAN | Urvan (E24) | 05/87 | 04/94 | ✓ |  |
|--------|-------------|-------|-------|---|--|

**961 680**

|        |                                    |       |       |   |  |
|--------|------------------------------------|-------|-------|---|--|
| NISSAN | Cherry 140 A (N10)                 | 81    | 81    | ✓ |  |
| NISSAN | Cherry 1.5 (N10)                   | 82    | 82    | ✓ |  |
| NISSAN | Cherry 1.5, 1.6, 1.7 Diesel (N12)  | 82    | 87    | ✓ |  |
| NISSAN | Prairie 1.5, 1.8 (M10)             | 82    | 88    | ✓ |  |
| NISSAN | Prairie 2.0i (M10)                 | 83    | 09/88 | ✓ |  |
| NISSAN | Pulsar (N10)                       | 08/78 | 01/82 | ✓ |  |
| NISSAN | Pulsar 1.5 Turbo, 1.7 Diesel (N12) | 82    | 85    | ✓ |  |
| NISSAN | Sunny 1.5, 1.6 (B11)               | 82    | 85    | ✓ |  |

**961 701**

|        |                    |       |       |   |  |
|--------|--------------------|-------|-------|---|--|
| NISSAN | Primera 4WD (P10E) | 04/91 | 09/94 | ✓ |  |
|--------|--------------------|-------|-------|---|--|

**961 724**

|        |                                |       |    |   |  |
|--------|--------------------------------|-------|----|---|--|
| NISSAN | Vanette 1.5 (C22)              | 87    | 95 | ✓ |  |
| NISSAN | Vanette 2.0 Diesel, 2.4i (C22) | 09/86 | 95 | ✓ |  |
| NISSAN | Vanette 2.3 Diesel (C23M)      | 07/92 | 95 | ✓ |  |

**961 751**

|        |                             |       |    |  |   |
|--------|-----------------------------|-------|----|--|---|
| NISSAN | 200 SX 1.8i 16V Turbo (S13) | 09/88 | 93 |  | ✓ |
| NISSAN | 200 SX 2.0i 16V Turbo (S14) | 09/94 | 95 |  | ✓ |

**961 753**

|        |                             |       |    |   |  |
|--------|-----------------------------|-------|----|---|--|
| NISSAN | 300 ZX 3.0i 24V Turbo (Z32) | 90    | 95 | ✓ |  |
| NISSAN | Serena 1.6 16V (C23M)       | 08/93 | 00 | ✓ |  |
| NISSAN | Serena 2.0 16V DOHC (C23M)  | 10/92 | 00 | ✓ |  |
| NISSAN | Serena 2.0 Diesel (C23M)    | 11/92 | 00 | ✓ |  |

**961 753**

|        |                                    |       |    |   |  |
|--------|------------------------------------|-------|----|---|--|
| NISSAN | Serena 2.3 Diesel (C23M)           | 01/95 | 00 | ✓ |  |
| NISSAN | Vanette Cargo 2.0 D (C23)          | 96    | 00 | ✓ |  |
| NISSAN | Vanette Cargo 2.3 D, 1.6 16V (C23) | 96    | 00 | ✓ |  |

**961 759**

|        |                             |       |    |   |  |
|--------|-----------------------------|-------|----|---|--|
| NISSAN | 200 SX 1.8i 16V Turbo (S13) | 09/88 | 93 | ✓ |  |
|--------|-----------------------------|-------|----|---|--|

**961 796**

|        |                                      |    |       |   |  |
|--------|--------------------------------------|----|-------|---|--|
| NISSAN | Cherry 1.0, 1.3 (N10)                | 82 | 82    | ✓ |  |
| NISSAN | Cherry 1.0, 1.3 (N12)                | 82 | 87    | ✓ |  |
| NISSAN | March 1.0, 1.2, Micra 1.0, 1.2 (K10) | 83 | 10/88 | ✓ |  |
| NISSAN | Pulsar 1.0, 1.3 (N12)                | 82 | 85    | ✓ |  |
| NISSAN | Sunny 1.3 (B11)                      | 82 | 85    | ✓ |  |

**961 801**

|        |  |       |    |   |  |
|--------|--|-------|----|---|--|
| FORD   | Maverick                               | 08/93 | 98 | ✓ |  |
| NISSAN | King Cab, King Cab 4WD (D21)           | 09/85 | 92 | ✓ |  |
| NISSAN | Pathfinder (D21)                       | 08/87 | 93 | ✓ |  |
| NISSAN | Pathfinder 3.3 V6, 3.5 V6 (R50)        | 97    | 00 | ✓ |  |
| NISSAN | Pick Up, Pick Up 4WD (D22)             | 98    | 04 | ✓ |  |
| NISSAN | Terrano I 2.4i, 2.7 Diesel (WD21)      | 08/87 | 94 | ✓ |  |
| NISSAN | Terrano I 2.7 Turbo Diesel (WD21)      | 08/87 | 94 | ✓ |  |
| NISSAN | Terrano I 3.0i (WD21)                  | 08/87 | 94 | ✓ |  |
| NISSAN | Terrano II 2.4i, 2.7 TD, 2.7 Tdi (R20) | 08/93 | 04 | ✓ |  |
| NISSAN | Terrano II 3.0 Di (R20)                | 02    | 04 | ✓ |  |

**961 808**

|        |                     |       |       |   |  |
|--------|---------------------|-------|-------|---|--|
| NISSAN | Atlas Cabstar (F22) | 01/82 | 89    | ✓ |  |
| NISSAN | King Cab (T20)      | 80    | 85    | ✓ |  |
| NISSAN | Urvan (E21)         | 82    | 87    | ✓ |  |
| NISSAN | Urvan (E23)         | 82    | 05/87 | ✓ |  |

**961 819**

|        |                      |       |    |   |  |
|--------|----------------------|-------|----|---|--|
| NISSAN | Murano 3.5 4x4 (Z50) | 03/05 | 06 | ✓ |  |
|--------|----------------------|-------|----|---|--|

**961 828**

|        |             |    |    |   |  |
|--------|-------------|----|----|---|--|
| NISSAN | 350 Z (Z33) | 03 | 05 | ✓ |  |
|--------|-------------|----|----|---|--|

**961 900**

|        |                                      |       |    |   |  |
|--------|--------------------------------------|-------|----|---|--|
| NISSAN | Almera Tino 1.8i 16V, 2.0i 16V (V10) | 08/00 | 04 | ✓ |  |
| NISSAN | Almera Tino 2.2 Di, 2.2 dCi (V10)    | 08/00 | 04 | ✓ |  |
| NISSAN | Maxima III 2.0i V6 24V (A33)         | 03/00 | 04 | ✓ |  |
| NISSAN | Maxima III 2.5i V6 24V (A33)         | 03/00 | 04 | ✓ |  |
| NISSAN | Maxima III 3.0i V6 24V (A33)         | 03/00 | 04 | ✓ |  |
| NISSAN | Primera 1.6i 16V, 1.8i 16V (P12)     | 03/02 | 05 | ✓ |  |
| NISSAN | Primera 1.9 dCi, 2.2 dCi (P12)       | 04/03 | 05 | ✓ |  |
| NISSAN | Primera 2.0i 16V, 2.2 Di (P12)       | 03/02 | 05 | ✓ |  |
| NISSAN | Primera Wagon 1.8i 16V (WP12)        | 03/02 | 04 | ✓ |  |
| NISSAN | Primera Wagon 2.0i 16V (WP12)        | 03/02 | 04 | ✓ |  |
| NISSAN | Primera Wagon 2.2 Di (WP12)          | 03/02 | 04 | ✓ |  |
| NISSAN | X-Trail 2.0i 16V 4x4 (T30)           | 07/01 | 04 | ✓ |  |
| NISSAN | X-Trail 2.2 dCi 4x4 (T30)            | 07/01 | 04 | ✓ |  |
| NISSAN | X-Trail 2.5i 16V 4x4 (T30)           | 01/03 | 04 | ✓ |  |

**961 904**

|        |                      |       |       |   |  |
|--------|----------------------|-------|-------|---|--|
| NISSAN | Patrol, Safari (160) | 11/79 | 08/88 | ✓ |  |
|--------|----------------------|-------|-------|---|--|

**961 964**

|        |                             |       |    |   |  |
|--------|-----------------------------|-------|----|---|--|
| NISSAN | 200 SX 2.0i 16V Turbo (S14) | 09/94 | 95 | ✓ |  |
|--------|-----------------------------|-------|----|---|--|

**961 965**

|        |                                |       |    |   |  |
|--------|--------------------------------|-------|----|---|--|
| NISSAN | Patrol GR II 2.8 TDI (Y61)     | 10/97 | 04 | ✓ |  |
| NISSAN | Patrol GR II 3.0 TDI 16V (Y61) | 02/00 | 04 | ✓ |  |
| NISSAN | Patrol GR II 4.5i (Y61)        | 10/97 | 04 | ✓ |  |

**962 241**

|        |                                   |       |       |  |   |
|--------|-----------------------------------|-------|-------|--|---|
| NISSAN | Almera I 1.4i 16V, 1.6i 16V (N15) | 07/95 | 07/00 |  | ✓ |
| NISSAN | Almera I 2.0i 16V GTI (N15)       | 07/95 | 07/00 |  | ✓ |
| NISSAN | Almera I 2.0 Diesel (N15)         | 07/95 | 07/00 |  | ✓ |

| 962 286 |   |       |       |    |  |  |   |
|---------|---|-------|-------|----|--|--|---|
| NISSAN  | Laurel                                  | (C32) | 86    | 90 |  |  | ✓ |
| 962 413 |   |       |       |    |  |  |   |
| NISSAN  | Patrol GR I 2.8 Turbo Diesel 4WD (Y60)  | 08/88 | 05/97 |    |  |  | ✓ |
| NISSAN  | Patrol GR I 4.2i 4WD (Y60)              | 10/91 | 05/97 |    |  |  | ✓ |
| NISSAN  | Patrol GR I 4.2 Diesel 4WD (Y60)        | 10/91 | 05/97 |    |  |  | ✓ |
| NISSAN  | Patrol GR I 4.2 Turbo Diesel 4WD (Y60)  | 10/91 | 05/97 |    |  |  | ✓ |
| NISSAN  | Patrol GR II 2.8 TDI (Y61)              | 10/97 | 04    |    |  |  | ✓ |
| NISSAN  | Patrol GR II 3.0 TDI 16V (Y61)          | 02/00 | 04    |    |  |  | ✓ |
| NISSAN  | Patrol GR II 4.5i (Y61)                 | 10/97 | 04    |    |  |  | ✓ |
| NISSAN  | Safari 2.8 Turbo Diesel 4WD (Y60)       | 08/88 | 01/94 |    |  |  | ✓ |
| NISSAN  | Safari 4.2 KAT 4WD (Y60)                | 10/91 | 01/94 |    |  |  | ✓ |
| NISSAN  | Safari 4.2 Diesel 4WD (Y60)             | 10/91 | 01/94 |    |  |  | ✓ |
| 962 435 |   |       |       |    |  |  |   |
| NISSAN  | King Cab, King Cab 4WD (D21)            | 09/85 | 92    |    |  |  | ✓ |
| NISSAN  | Pathfinder (D21)                        | 08/87 | 93    |    |  |  | ✓ |
| NISSAN  | Pick Up (D22)                           | 98    | 04    |    |  |  | ✓ |
| NISSAN  | Terrano I 2.4i, 2.7 Diesel (WD21)       | 08/87 | 94    |    |  |  | ✓ |
| NISSAN  | Terrano I 2.7 Turbo Diesel, 3.0i (WD21) | 08/87 | 94    |    |  |  | ✓ |
| NISSAN  | Urvan (E24)                             | 05/87 | 04/94 |    |  |  | ✓ |
| 962 481 |   |       |       |    |  |  |   |
| NISSAN  | March 1.0i 16V, Micra 1.0i 16V (K11)    | 92    | 02/03 |    |  |  | ✓ |
| NISSAN  | March 1.3i 16V, Micra 1.3i 16V (K11)    | 92    | 10/00 |    |  |  | ✓ |
| NISSAN  | March 1.4i 16V, Micra 1.4i 16V (K11)    | 10/00 | 02/03 |    |  |  | ✓ |
| NISSAN  | March 1.5 Diesel, Micra 1.5 Diesel(K11) | 98    | 02/03 |    |  |  | ✓ |
| 962 548 |   |       |       |    |  |  |   |
| NISSAN  | March 1.0, 1.2, Micra 1.0, 1.2 (K10)    | 11/88 | 92    |    |  |  | ✓ |
| NISSAN  | March 1.0i 16V, Micra 1.0i 16V (K11)    | 92    | 02/03 |    |  |  | ✓ |
| NISSAN  | March 1.3i 16V, Micra 1.3i 16V (K11)    | 92    | 10/00 |    |  |  | ✓ |
| NISSAN  | March 1.4i 16V, Micra 1.4i 16V (K11)    | 10/00 | 02/03 |    |  |  | ✓ |
| NISSAN  | March 1.5 Diesel, Micra 1.5 Diesel(K11) | 98    | 02/03 |    |  |  | ✓ |
| 962 682 |   |       |       |    |  |  |   |
| NISSAN  | March 1.0, 1.2, Micra 1.0, 1.2 (K10)    | 83    | 10/88 |    |  |  | ✓ |
| 962 684 |   |       |       |    |  |  |   |
| NISSAN  | 200 SX 2.0 (S12)                        | 10/83 | 11/84 |    |  |  | ✓ |
| NISSAN  | Bluebird (910)                          | 80    | 05/84 |    |  |  | ✓ |
| NISSAN  | Laurel (C31)                            | 81    | 85    |    |  |  | ✓ |
| NISSAN  | Silvia                                  | 80    | 89    |    |  |  | ✓ |
| NISSAN  | Vanette 1.5 (C22)                       | 87    | 95    |    |  |  | ✓ |
| NISSAN  | Vanette 2.0 Diesel (C22)                | 09/86 | 95    |    |  |  | ✓ |
| NISSAN  | Vanette 2.3 Diesel (C23M)               | 07/92 | 95    |    |  |  | ✓ |
| NISSAN  | Vanette 2.4i (C22)                      | 09/86 | 95    |    |  |  | ✓ |
| 962 686 |   |       |       |    |  |  |   |
| NISSAN  | Atlas Cabstar (F22)                     | 01/82 | 10/88 |    |  |  | ✓ |
| NISSAN  | King Cab (720)                          | 80    | 85    |    |  |  | ✓ |
| NISSAN  | Urvan (E21, E23)                        | 82    | 87    |    |  |  | ✓ |
| 962 703 |   |       |       |    |  |  |   |
| NISSAN  | Primera 1.6i 16V, 2.0i 16V (P10E)       | 06/90 | 06/96 |    |  |  | ✓ |
| NISSAN  | Primera 2.0 Diesel (P10E)               | 06/90 | 06/96 |    |  |  | ✓ |
| 962 705 |   |       |       |    |  |  |   |
| NISSAN  | Primera 1.6i 16V (P10E)                 | 06/90 | 06/96 |    |  |  | ✓ |
| NISSAN  | Primera 2.0i 16V, 2.0 Diesel (P10E)     | 06/90 | 06/96 |    |  |  | ✓ |
| 962 712 |   |       |       |    |  |  |   |
| NISSAN  | 100 NX 1.6i 16V (B13)                   | 10/91 | 98    |    |  |  | ✓ |
| NISSAN  | Almera I 1.4i 16V, 1.6i 16V (N15)       | 07/95 | 07/00 |    |  |  | ✓ |
| NISSAN  | Almera I 2.0i 16V GTI (N15)             | 07/95 | 07/00 |    |  |  | ✓ |
| NISSAN  | Almera I 2.0 Diesel (N15)               | 07/95 | 07/00 |    |  |  | ✓ |
| NISSAN  | Presea 1.5i, 2.0i (R10)                 | 05/91 | 96    |    |  |  | ✓ |
| NISSAN  | Pulsar 1.4, 1.6, 2.0 (N14)              | 10/90 | 00    |    |  |  | ✓ |
| NISSAN  | Sentra 1.3, 1.4, 1.5, 2.0 Diesel (B14)  | 01/94 | 09/98 |    |  |  | ✓ |
| NISSAN  | Sentra 1.6 (B13)                        | 09/90 | 09/98 |    |  |  | ✓ |

| 962 712    |   |       |       |    |  |  |   |
|------------|---|-------|-------|----|--|--|---|
| NISSAN     | Sentra 2.0 (B13)                        | 09/90 | 12/93 |    |  |  | ✓ |
| NISSAN     | Sunny 1.3, 1.4i 16V, 1.5 (B14)          | 04/94 | 96    |    |  |  | ✓ |
| NISSAN     | Sunny 1.4i 16V, 1.6i 16V (N14)          | 10/90 | 96    |    |  |  | ✓ |
| NISSAN     | Sunny 1.6i, 2.0 (B13)                   | 09/90 | 10/94 |    |  |  | ✓ |
| NISSAN     | Sunny 1.6i 16V, 2.0 Diesel (B14)        | 04/94 | 96    |    |  |  | ✓ |
| NISSAN     | Sunny 2.0i 16V, 2.0 Diesel (N14)        | 10/90 | 96    |    |  |  | ✓ |
| 962 714    |   |       |       |    |  |  |   |
| NISSAN     | 100 NX 1.6i 16V, 2.0i 16V GTI (B13)     | 10/91 | 98    |    |  |  | ✓ |
| NISSAN     | Presea 1.5i, 2.0i (R10)                 | 05/91 | 96    |    |  |  | ✓ |
| NISSAN     | Pulsar 1.4, 1.6, 2.0 (N14)              | 10/90 | 03/93 |    |  |  | ✓ |
| NISSAN     | Sentra 1.6, 2.0 (B13)                   | 09/90 | 12/93 |    |  |  | ✓ |
| NISSAN     | Sunny 1.4i 16V (N14)                    | 10/90 | 96    |    |  |  | ✓ |
| NISSAN     | Sunny 1.6, 2.0 (B13)                    | 09/90 | 10/94 |    |  |  | ✓ |
| NISSAN     | Sunny 1.6i 16V, 2.0i 16V (N14)          | 10/90 | 96    |    |  |  | ✓ |
| NISSAN     | Sunny 2.0i 16V GTI (N14)                | 10/90 | 96    |    |  |  | ✓ |
| NISSAN     | Sunny 2.0 Diesel (N14)                  | 10/90 | 96    |    |  |  | ✓ |
| 962 716    |   |       |       |    |  |  |   |
| NISSAN     | Pulsar 1.6i 16V DOHC (B12, N13)         | 86    | 90    |    |  |  | ✓ |
| NISSAN     | Pulsar 1.8i 16V DOHC (B12, N13)         | 86    | 90    |    |  |  | ✓ |
| NISSAN     | Sunny 1.6i 16V GTI (B12, N13)           | 86    | 90    |    |  |  | ✓ |
| NISSAN     | Sunny 1.8i 16V GTI (B12, N13)           | 86    | 90    |    |  |  | ✓ |
| 962 718    |   |       |       |    |  |  |   |
| NISSAN     | Pulsar 1.3, 1.4, 1.6 (B12, N13)         | 86    | 90    |    |  |  | ✓ |
| NISSAN     | Pulsar 1.7 Diesel (B12, N13)            | 86    | 90    |    |  |  | ✓ |
| NISSAN     | Sunny 1.3, 1.4, 1.5, 1.6 (B12, N13)     | 86    | 89    |    |  |  | ✓ |
| NISSAN     | Sunny 1.7 Diesel (B12, N13)             | 86    | 90    |    |  |  | ✓ |
| 962 755    |   |       |       |    |  |  |   |
| NISSAN     | 300 ZX 3.0i 24V Turbo (Z32)             | 90    | 95    |    |  |  | ✓ |
| 962 757    |   |       |       |    |  |  |   |
| NISSAN     | 300 ZX 3.0i 24V Turbo (Z32)             | 90    | 95    |    |  |  | ✓ |
| 962 760    |   |       |       |    |  |  |   |
| NISSAN     | Bluebird, Bluebird Turbo (U11)          | 11/83 | 90    |    |  |  | ✓ |
| NISSAN     | Bluebird, Bluebird Turbo (T12)          | 12/85 | 89    |    |  |  | ✓ |
| NISSAN     | Bluebird (T12)                          | 90    | 02/92 |    |  |  | ✓ |
| NISSAN     | Liberta, Liberta Turbo (T12)            | 12/85 | 89    |    |  |  | ✓ |
| NISSAN     | Stanza (T11)                            | 82    | 89    |    |  |  | ✓ |
| NISSAN     | Stanza Turbo (T12)                      | 12/85 | 89    |    |  |  | ✓ |
| NISSAN     | Stanza (T12)                            | 90    | 92    |    |  |  | ✓ |
| 962 762    |   |       |       |    |  |  |   |
| NISSAN     | Bluebird (U11)                          | 11/83 | 90    |    |  |  | ✓ |
| NISSAN     | Bluebird, Liberta, Stanza (T12)         | 12/85 | 89    |    |  |  | ✓ |
| 962 776    |   |       |       |    |  |  |   |
| ALFA ROMEO | Arna                                    |       | 83    | 86 |  |  | ✓ |
| NISSAN     | Cherry 140 A (N10)                      | 81    | 81    |    |  |  | ✓ |
| NISSAN     | Cherry 1.0, 1.3, 1.5 (N10)              | 82    | 82    |    |  |  | ✓ |
| NISSAN     | Cherry 1.0, 1.3, 1.5, 1.6, 1.7 D. (N12) | 82    | 87    |    |  |  | ✓ |
| NISSAN     | Prairie 1.5 (M10)                       | 82    | 88    |    |  |  | ✓ |
| NISSAN     | Prairie 1.8 (M10)                       | 83    | 88    |    |  |  | ✓ |
| NISSAN     | Prairie 2.0i (M10)                      | 83    | 09/88 |    |  |  | ✓ |
| NISSAN     | Pulsar (N10)                            | 08/78 | 01/82 |    |  |  | ✓ |
| NISSAN     | Pulsar 1.0, 1.3, 1.5 Turbo (N12)        | 82    | 85    |    |  |  | ✓ |
| NISSAN     | Pulsar 1.7 Diesel (N12)                 | 82    | 85    |    |  |  | ✓ |
| NISSAN     | Sunny 1.3, 1.5, 1.6 (B11)               | 82    | 85    |    |  |  | ✓ |
| 962 779    |   |       |       |    |  |  |   |
| NISSAN     | Maxima I 3.0i V6 12V (J30)              | 12/88 | 06/94 |    |  |  | ✓ |
| 962 807    |   |       |       |    |  |  |   |
| NISSAN     | Maxima II 2.0i V6 24V (A32)             | 07/94 | 08/00 |    |  |  | ✓ |
| NISSAN     | Maxima II 2.5i V6 24V (A32)             | 07/94 | 08/00 |    |  |  | ✓ |
| NISSAN     | Maxima II 3.0i V6 24V (A32)             | 07/94 | 08/00 |    |  |  | ✓ |

**SATZ-VERZEICHNIS**  
**KITS INDEX**  
**INDEX DES KITS**



**962 810**

|        |                          |       |       |       |   |
|--------|--------------------------|-------|-------|-------|---|
| NISSAN | Bluebird                 | (U12) | 07/89 | 90    | ✓ |
| NISSAN | Bluebird 2.4             | (U13) | 06/92 | 05/93 | ✓ |
| NISSAN | Prairie Pro 2.0i         | (M11) | 10/88 | 94    | ✓ |
| NISSAN | Prairie Pro 2.4i         | (M11) | 92    | 94    | ✓ |
| NISSAN | Primera Wagon 1.6i 16V   | (W10) | 06/90 | 97    | ✓ |
| NISSAN | Primera Wagon 2.0i 16V   | (W10) | 06/90 | 97    | ✓ |
| NISSAN | Primera Wagon 2.0 Diesel | (W10) | 06/90 | 97    | ✓ |

**962 823**

|        |                |       |       |       |   |
|--------|----------------|-------|-------|-------|---|
| NISSAN | Murano 3.5 4x4 | (Z50) | 03/05 | 12/06 | ✓ |
|--------|----------------|-------|-------|-------|---|

**962 824**

|        |       |  |       |    |   |
|--------|-------|--|-------|----|---|
| NISSAN | Z 350 |  | 01/03 | 04 | ✓ |
|--------|-------|--|-------|----|---|

**962 841**

|        |                              |       |       |       |   |
|--------|------------------------------|-------|-------|-------|---|
| NISSAN | Patrol GR I 2.8 Turbo Diesel | (Y60) | 08/88 | 05/97 | ✓ |
| NISSAN | Safari 2.8 Turbo Diesel 2WD  | (Y60) | 08/88 | 01/94 | ✓ |

**962 847**

|        |              |       |       |    |   |
|--------|--------------|-------|-------|----|---|
| NISSAN | King Cab 4WD | (D21) | 11/85 | 89 | ✓ |
|--------|--------------|-------|-------|----|---|

**962 853**

|        |                       |       |       |       |   |
|--------|-----------------------|-------|-------|-------|---|
| NISSAN | Maxima I 3.0i V6 12V  | (J30) | 12/88 | 06/94 | ✓ |
| NISSAN | Maxima II 2.0i V6 24V | (A32) | 07/94 | 08/00 | ✓ |
| NISSAN | Maxima II 2.5i V6 24V | (A32) | 07/94 | 08/00 | ✓ |
| NISSAN | Maxima II 3.0i V6 24V | (A32) | 07/94 | 08/00 | ✓ |

**962 873**

|        |                            |        |       |    |   |
|--------|----------------------------|--------|-------|----|---|
| NISSAN | Primera 1.6i 16V, 1.8i 16V | (P12)  | 03/02 | 05 | ✓ |
| NISSAN | Primera 1.9 dCi, 2.2 dCi   | (P12)  | 04/03 | 05 | ✓ |
| NISSAN | Primera 2.0i 16V, 2.2 Di   | (P12)  | 03/02 | 05 | ✓ |
| NISSAN | Primera Wagon 1.8i 16V     | (WP12) | 03/02 | 04 | ✓ |
| NISSAN | Primera Wagon 2.0i 16V     | (WP12) | 03/02 | 04 | ✓ |
| NISSAN | Primera Wagon 2.2 Di       | (WP12) | 03/02 | 04 | ✓ |

**962 897**

|        |                      |       |       |    |   |
|--------|----------------------|-------|-------|----|---|
| NISSAN | X-Trail 2.0i 16V 4x4 | (T30) | 07/01 | 04 | ✓ |
| NISSAN | X-Trail 2.2 dCi 4x4  | (T30) | 07/01 | 04 | ✓ |
| NISSAN | X-Trail 2.5i 16V 4x4 | (T30) | 01/03 | 04 | ✓ |

**962 903**

|        |                              |       |       |    |   |
|--------|------------------------------|-------|-------|----|---|
| NISSAN | Almera Tino 1.8i 16V         | (V10) | 08/00 | 04 | ✓ |
| NISSAN | Almera Tino 2.0i 16V, 2.2 Di | (V10) | 08/00 | 04 | ✓ |
| NISSAN | Almera Tino 2.2 dCi          | (V10) | 09/03 | 04 | ✓ |
| NISSAN | Maxima III 2.0i V6 24V       | (A33) | 03/00 | 04 | ✓ |
| NISSAN | Maxima III 2.5i V6 24V       | (A33) | 03/00 | 04 | ✓ |
| NISSAN | Maxima III 3.0i V6 24V       | (A33) | 03/00 | 04 | ✓ |

**962 905**

|        |                |       |       |       |   |
|--------|----------------|-------|-------|-------|---|
| NISSAN | Patrol, Safari | (160) | 11/79 | 08/88 | ✓ |
|--------|----------------|-------|-------|-------|---|

**962 949**

|        |                     |        |       |       |   |
|--------|---------------------|--------|-------|-------|---|
| NISSAN | Serena 1.6 16V      | (C23M) | 08/93 | 00    | ✓ |
| NISSAN | Serena 2.0 16V DOHC | (C23M) | 10/92 | 04/96 | ✓ |
| NISSAN | Serena 2.0 Diesel   | (C23M) | 11/92 | 00    | ✓ |
| NISSAN | Serena 2.3 Diesel   | (C23M) | 01/95 | 00    | ✓ |

**962 981**

|        |                          |       |       |    |   |
|--------|--------------------------|-------|-------|----|---|
| NISSAN | Primera Wagon 1.6i 16V   | (W10) | 06/90 | 97 | ✓ |
| NISSAN | Primera Wagon 2.0i 16V   | (W10) | 06/90 | 97 | ✓ |
| NISSAN | Primera Wagon 2.0 Diesel | (W10) | 06/90 | 97 | ✓ |

**962 984**

|        |                     |        |       |    |   |
|--------|---------------------|--------|-------|----|---|
| NISSAN | Serena 2.0 16V DOHC | (C23M) | 05/96 | 00 | ✓ |
|--------|---------------------|--------|-------|----|---|

**962 985**

|        |                                  |       |       |    |   |
|--------|----------------------------------|-------|-------|----|---|
| FORD   | Maverick                         |       | 08/93 | 98 | ✓ |
| NISSAN | Pick Up 4WD                      | (D22) | 98    | 04 | ✓ |
| NISSAN | Terrano II 2.4i, 2.7 TD, 2.7 Tdi | (R20) | 08/93 | 04 | ✓ |
| NISSAN | Terrano II 3.0 Di                | (R20) | 02    | 04 | ✓ |
| NISSAN | Vanette Cargo 2.0 D, 2.3 D       | (C23) | 96    | 00 | ✓ |

**962 985**

|        |                       |       |    |    |   |
|--------|-----------------------|-------|----|----|---|
| NISSAN | Vanette Cargo 1.6 16V | (C23) | 96 | 00 | ✓ |
|--------|-----------------------|-------|----|----|---|

**962 986**

|        |                            |         |       |    |   |
|--------|----------------------------|---------|-------|----|---|
| NISSAN | Primera 1.6i 16V, 1.8i 16V | (P11E)  | 07/96 | 02 | ✓ |
| NISSAN | Primera 2.0i 16V           | (P11E)  | 07/96 | 02 | ✓ |
| NISSAN | Primera 2.0 Turbo Diesel   | (P11E)  | 07/96 | 02 | ✓ |
| NISSAN | Primera Wagon 1.6i 16V     | (WP11E) | 98    | 02 | ✓ |
| NISSAN | Primera Wagon 2.0i 16V     | (WP11E) | 98    | 02 | ✓ |
| NISSAN | Primera Wagon 2.0 Turbo D. | (WP11E) | 98    | 02 | ✓ |

**971 285**

|        |                 |  |       |       |   |
|--------|-----------------|--|-------|-------|---|
| SUBARU | Libero 1.2i     |  | 05/96 | 00    | ✓ |
| SUBARU | Libero 4WD 1.2i |  | 05/93 | 00    | ✓ |
| SUBARU | Vivio 660 4WD   |  | 93    | 06/97 | ✓ |

**971 290**

|        |                       |      |    |    |   |
|--------|-----------------------|------|----|----|---|
| DAEWOO | Korando (Ssangyong)   | (KJ) | 99 | 03 | ✓ |
| DAEWOO | Musso 4WD (Ssangyong) | (FJ) | 99 | 03 | ✓ |

**971 391**

|        |                          |  |    |    |   |
|--------|--------------------------|--|----|----|---|
| DAEWOO | Cielo 1500 MPI, 1800 MPI |  | 94 | 96 | ✓ |
| DAEWOO | Kalos                    |  | 02 | 04 | ✓ |
| DAEWOO | Lanos 1.4i, 1.5i SOHC    |  | 97 | 05 | ✓ |
| DAEWOO | Lemans                   |  | 92 | 93 | ✓ |
| DAEWOO | Nexia 1.5i 8V            |  | 95 | 97 | ✓ |
| DAEWOO | Racer                    |  | 95 | 00 | ✓ |

**971 393**

|        |                                 |  |    |    |   |
|--------|---------------------------------|--|----|----|---|
| DAEWOO | Cielo 1500 MPI, 1800 MPI        |  | 94 | 96 | ✓ |
| DAEWOO | Espero                          |  | 92 | 99 | ✓ |
| DAEWOO | Lanos 1.4i, 1.5i DOHC, 1.6i 16V |  | 97 | 05 | ✓ |
| DAEWOO | Nexia 1.5i 16V DOHC, 1.8i       |  | 95 | 97 | ✓ |
| DAEWOO | Nubira                          |  | 97 | 04 | ✓ |

**971 451**

|        |                |        |    |    |   |
|--------|----------------|--------|----|----|---|
| SUZUKI | SJ 410         | (SJ40) | 81 | 88 | ✓ |
| SUZUKI | SJ 413 Samurai |        | 84 | 88 | ✓ |
| SUZUKI | SJ 413 Samurai |        | 88 | 00 | ✓ |

**971 455**

|        |                |                |       |       |   |
|--------|----------------|----------------|-------|-------|---|
| DAEWOO | Fino, Mica     | Y3S112         | 93    | 94    | ✓ |
| DAEWOO | Tico           |                | 11/93 | 98    | ✓ |
| SUZUKI | Alto 0.8       | (SS80F, SS80G) | 81    | 07/94 | ✓ |
| SUZUKI | Alto 0.8 SB308 | (CA91, CB91)   | 81    | 07/94 | ✓ |
| SUZUKI | Maruti 0.8     | (CA91, CB91)   | 88    | 90    | ✓ |
| SUZUKI | Swift SA 310   | (AA41, AA43)   | 83    | 88    | ✓ |

**971 567**

|          |                 |        |    |    |   |
|----------|-----------------|--------|----|----|---|
| DAEWOO   | Damas           |        | 90 | 92 | ✓ |
| DAEWOO   | Labo            | Y7T51  | 90 | 92 | ✓ |
| SUZUKI   | Carry 1.0       | (DA21) | 86 | 98 | ✓ |
| SUZUKI   | Carry 1.3i 16V  | (DA32) | 99 | 02 | ✓ |
| SUZUKI   | Carry Super 0.8 | (DA21) | 85 | 88 | ✓ |
| SUZUKI   | Carry Super 1.0 | (DA21) | 85 | 02 | ✓ |
| VAUXHALL | Rascal          |        | 87 | 87 | ✓ |

**971 575**

|        |                |              |       |    |   |
|--------|----------------|--------------|-------|----|---|
| SUZUKI | Alto 1.0 SH410 | (FA11)       | 08/94 | 04 | ✓ |
| SUZUKI | Swift SA 310   | (AA41, AA43) | 08/86 | 88 | ✓ |
| SUZUKI | Swift SA 413   | (AA51, AA53) | 84    | 88 | ✓ |
| SUZUKI | Swift SF 310 H | (MAA44)      | 95    | 01 | ✓ |
| SUZUKI | Swift SF 413 H | (MAB35)      | 94    | 01 | ✓ |
| SUZUKI | Swift SF 413 H | (MAB35)      | 95    | 01 | ✓ |

**971 612**

|        |                          |              |    |       |   |
|--------|--------------------------|--------------|----|-------|---|
| SUZUKI | Grand Vitara 1.6i 16V    | (TA03, TB03) | 98 | 09/05 | ✓ |
| SUZUKI | Grand Vitara 2.0i 16V    | (TA52, TD32) | 97 | 09/05 | ✓ |
| SUZUKI | Grand Vitara 2.0 TD Int. | (TD32, TD82) | 97 | 09/05 | ✓ |
| SUZUKI | Grand Vitara 2.0 HDI     | (TD32, TD82) | 01 | 09/05 | ✓ |
| SUZUKI | Grand Vitara 2.5 V6 24V  | (TD62)       | 97 | 09/05 | ✓ |

**971 612**

|        |                                |       |       |   |  |
|--------|--------------------------------|-------|-------|---|--|
| SUZUKI | Grand Vitara 2.7 V6 24V (HT92) | 01    | 09/05 | ✓ |  |
| SUZUKI | Jimny 1.3i 16V, 4WD (JA33V)    | 98    | 04    | ✓ |  |
| SUZUKI | Vitara                         | 88    | 00    | ✓ |  |
| SUZUKI | X-90 1.6i 16V, 1.6i 16V 4x4    | 09/95 | 06/02 | ✓ |  |

**971 615**

|        |                  |    |    |   |  |
|--------|------------------|----|----|---|--|
| SUBARU | Leone, Leone 4WD | 80 | 91 | ✓ |  |
|--------|------------------|----|----|---|--|

**971 631**

|        |                               |       |    |   |  |
|--------|-------------------------------|-------|----|---|--|
| SUBARU | Leone, Leone 4WD              | 01/85 | 91 | ✓ |  |
| SUBARU | Loyale, Loyale 4WD            | 89    | 94 | ✓ |  |
| SUBARU | XT 1.8i Turbo, 1.8i Turbo 4WD | 84    | 91 | ✓ |  |

**971 635**

|        |                                 |       |       |   |  |
|--------|---------------------------------|-------|-------|---|--|
| SUBARU | Justy, Justy 4WD                | 08/86 | 09/88 | ✓ |  |
| SUBARU | Libero 1.0, Libero 4WD 1.0, 1.2 | 08/86 | 04/93 | ✓ |  |

**971 641**

|        |                  |       |       |   |  |
|--------|------------------|-------|-------|---|--|
| SUBARU | Justy, Justy 4WD | 10/88 | 09/95 | ✓ |  |
|--------|------------------|-------|-------|---|--|

**971 707**

|        |                                      |       |       |   |   |
|--------|--------------------------------------|-------|-------|---|---|
| SUBARU | Forester 4WD 2.0i 16V                | 97    | 05    | ✓ |   |
| SUBARU | Forester 4WD 2.0i 16V Turbo          | 98    | 05    | ✓ |   |
| SUBARU | Forester 4WD 2.5i 16V                | 03    | 05    | ✓ |   |
| SUBARU | Impreza 1.6i 16V, 1.8i 16V, 2.0i 16V | 98    | 04    | ✓ |   |
| SUBARU | Impreza 4WD 1.6i 16V, 1.8i 16V       | 92    | 04    | ✓ |   |
| SUBARU | Impreza 4WD 2.0i 16V                 | 92    | 04    | ✓ |   |
| SUBARU | Impreza 4WD 2.0i 16V Turbo           | 92    | 04    | ✓ |   |
| SUBARU | Legacy 1.8i 16V, 4WD 1.8i 16V        | 90    | 04    | ✓ |   |
| SUBARU | Legacy 2.0i 16V, 4WD 2.0i 16V        | 91    | 04    | ✓ |   |
| SUBARU | Legacy 2.2i 16V, 4WD 2.2i 16V        | 90    | 04    | ✓ |   |
| SUBARU | Legacy 4WD 2.0i 16V Turbo            | 91    | 04    | ✓ |   |
| SUBARU | Legacy 4WD 2.5i 16V                  | 96    | 04    | ✓ |   |
| SUBARU | Legacy IV                            | 09/03 | 06    | ✓ |   |
| SUBARU | Outback                              | 10/00 | 06    | ✓ |   |
| SUBARU | Vivio 660 4WD                        | 93    | 06/97 |   | ✓ |

**971 711**

|        |                                 |       |       |   |  |
|--------|---------------------------------|-------|-------|---|--|
| SUBARU | Justy 4WD                       | 10/95 | 04    | ✓ |  |
| SUZUKI | Swift SF 310 (AA44)             | 89    | 94    | ✓ |  |
| SUZUKI | Swift SF 413 (AA35, AB35, AH35) | 89    | 03/96 | ✓ |  |
| SUZUKI | Swift SF 413 Cabrio (AK35)      | 91    | 03/96 | ✓ |  |
| SUZUKI | Swift SF 413 4WD (AA35, AF35)   | 89    | 03/96 | ✓ |  |

**971 723**

|        |                         |       |       |   |  |
|--------|-------------------------|-------|-------|---|--|
| SUZUKI | Baleno, Baleno 4WD (EG) | 95    | 04    | ✓ |  |
| SUZUKI | Esteem                  | 06/89 | 92    | ✓ |  |
| SUZUKI | Swift SF 413 GTI (AA34) | 89    | 01    | ✓ |  |
| SUZUKI | Swift SF 416 (AH14)     | 89    | 03/96 | ✓ |  |
| SUZUKI | Swift SF 416 4WD (AJ14) | 90    | 03/96 | ✓ |  |

**971 821**

|        |                     |    |    |   |  |
|--------|---------------------|----|----|---|--|
| SUZUKI | Liana 2WD, 4WD (ER) | 01 | 06 | ✓ |  |
|--------|---------------------|----|----|---|--|

**971 917**

|        |       |    |    |   |  |
|--------|-------|----|----|---|--|
| DAEWOO | Matiz | 98 | 05 | ✓ |  |
|--------|-------|----|----|---|--|

**971 940**

|        |                |    |    |   |  |
|--------|----------------|----|----|---|--|
| DAEWOO | Evanda 2.0 16V | 02 | 05 | ✓ |  |
| DAEWOO | Leganza        | 97 | 03 | ✓ |  |
| DAEWOO | Rezzo, Tacuma  | 01 | 03 | ✓ |  |

**972 275**

|        |                        |       |       |   |  |
|--------|------------------------|-------|-------|---|--|
| SUZUKI | Wagon R+ 1.2i 4WD (EM) | 98    | 05/00 | ✓ |  |
| SUZUKI | Wagon R+ 1.3i 4WD (MM) | 10/01 | 04    | ✓ |  |
| SUZUKI | Wagon R+ 1.3 DDiS (MM) | 09/03 | 04    | ✓ |  |

**972 299**

|        |                |    |    |   |  |
|--------|----------------|----|----|---|--|
| SUZUKI | Baleno (EG)    | 95 | 04 | ✓ |  |
| SUZUKI | Liana 2WD (ER) | 01 | 06 | ✓ |  |

**972 389**

|        |                                    |    |    |   |  |
|--------|------------------------------------|----|----|---|--|
| DAEWOO | Cielo 1500 MPI, 1800 MPI           | 94 | 96 | ✓ |  |
| DAEWOO | Espero                             | 92 | 99 | ✓ |  |
| DAEWOO | Lanos 1.4i, 1.5i SOHC, 1.6i 16V    | 97 | 05 | ✓ |  |
| DAEWOO | Lebens                             | 92 | 93 | ✓ |  |
| DAEWOO | Nexia 1.5i 8V, 1.5i 16V DOHC, 1.8i | 95 | 97 | ✓ |  |
| DAEWOO | Nubira                             | 97 | 04 | ✓ |  |
| DAEWOO | Racer                              | 95 | 00 | ✓ |  |

**972 397**

|        |                |    |    |   |  |
|--------|----------------|----|----|---|--|
| DAEWOO | Espero         | 92 | 99 | ✓ |  |
| DAEWOO | Lanos 1.6i 16V | 97 | 05 | ✓ |  |

**972 453**

|        |                             |       |       |   |  |
|--------|-----------------------------|-------|-------|---|--|
| DAEWOO | Fino, Micra Y3S112          | 93    | 94    | ✓ |  |
| DAEWOO | Mica Y3S112                 | 93    | 94    | ✓ |  |
| DAEWOO | Tico                        | 11/93 | 98    | ✓ |  |
| SUZUKI | Alto 0.8 (SS80F, SS80G)     | 81    | 07/94 | ✓ |  |
| SUZUKI | Alto 0.8 SB308 (CA91, CB91) | 81    | 07/94 | ✓ |  |
| SUZUKI | Alto 1.0 SH410 (FA11)       | 08/94 | 04    | ✓ |  |
| SUZUKI | Carry 0.8 (ST90)            | 81    | 88    | ✓ |  |
| SUZUKI | Maruti 0.8 (CA91, CB91)     | 88    | 90    | ✓ |  |
| SUZUKI | Swift SA 310 (AA41, AA43)   | 83    | 88    | ✓ |  |
| SUZUKI | Swift SA 310 (AA41, AA43)   | 08/86 | 88    | ✓ |  |
| SUZUKI | Swift SA 413 (AA51, AA53)   | 84    | 88    | ✓ |  |
| SUZUKI | Swift SF 310 (AA44)         | 89    | 94    | ✓ |  |
| SUZUKI | Wagon R+ 1.0i (EM)          | 97    | 05/00 | ✓ |  |
| SUZUKI | Wagon R+ 1.2i (EM)          | 98    | 05/00 | ✓ |  |

**972 465**

|        |                   |    |    |   |  |
|--------|-------------------|----|----|---|--|
| SUBARU | Leone 4WD         | 80 | 91 | ✓ |  |
| SUBARU | Loyale 4WD        | 89 | 94 | ✓ |  |
| SUBARU | XT 1.8i Turbo 4WD | 84 | 91 | ✓ |  |

**972 571**

|        |                            |    |       |   |  |
|--------|----------------------------|----|-------|---|--|
| SUZUKI | Jimny 1.3i 16V (JA33V)     | 98 | 04    | ✓ |  |
| SUZUKI | Jimny 4WD 1.3i 16V (JB33V) | 98 | 05/99 | ✓ |  |
| SUZUKI | SJ 413 Samurai             | 88 | 00    | ✓ |  |

**972 573**

|          |                        |    |    |   |  |
|----------|------------------------|----|----|---|--|
| SUZUKI   | Carry 1.0 (DA21)       | 86 | 98 | ✓ |  |
| SUZUKI   | Carry 1.3i 16V (DA32)  | 99 | 02 | ✓ |  |
| SUZUKI   | Carry Super 0.8 (DA21) | 85 | 88 | ✓ |  |
| SUZUKI   | Carry Super 1.0 (DA21) | 85 | 02 | ✓ |  |
| SUZUKI   | SJ 410 (SJ40)          | 81 | 88 | ✓ |  |
| SUZUKI   | SJ 413 Samurai         | 84 | 88 | ✓ |  |
| VAUXHALL | Rascal                 | 87 | 87 | ✓ |  |

**972 633**

|        |               |    |    |   |  |
|--------|---------------|----|----|---|--|
| SUBARU | Leone         | 80 | 91 | ✓ |  |
| SUBARU | Loyale        | 89 | 94 | ✓ |  |
| SUBARU | XT 1.8i Turbo | 84 | 91 | ✓ |  |

**972 637**

|        |                  |    |       |   |  |
|--------|------------------|----|-------|---|--|
| SUBARU | Justy, Justy 4WD | 84 | 09/95 | ✓ |  |
|--------|------------------|----|-------|---|--|

**972 688**

|        |                             |       |       |   |  |
|--------|-----------------------------|-------|-------|---|--|
| SUZUKI | Vitara                      | 88    | 00    | ✓ |  |
| SUZUKI | X-90 1.6i 16V, 1.6i 16V 4x4 | 09/95 | 06/02 | ✓ |  |

**972 709**

|        |                                      |    |    |   |  |
|--------|--------------------------------------|----|----|---|--|
| SUBARU | Forester 4WD 2.0i 16V                | 97 | 05 | ✓ |  |
| SUBARU | Forester 4WD 2.0i 16V Turbo          | 98 | 05 | ✓ |  |
| SUBARU | Forester 4WD 2.5i 16V                | 03 | 05 | ✓ |  |
| SUBARU | Impreza 1.6i 16V, 1.8i 16V           | 98 | 04 | ✓ |  |
| SUBARU | Impreza 2.0i 16V                     | 98 | 04 | ✓ |  |
| SUBARU | Impreza 4WD 1.6i 16V, 1.8i 16V       | 92 | 04 | ✓ |  |
| SUBARU | Impreza 4WD 2.0i 16V, 2.0i 16V Turbo | 92 | 04 | ✓ |  |
| SUBARU | Legacy 1.8i 16V, 4WD 1.8i 16V        | 90 | 04 | ✓ |  |
| SUBARU | Legacy 2.0i 16V, 4WD 2.0i 16V        | 91 | 04 | ✓ |  |
| SUBARU | Legacy 2.2i 16V, 4WD 2.2i 16V        | 90 | 04 | ✓ |  |

**972 709**

|        |                           |       |    |   |
|--------|---------------------------|-------|----|---|
| SUBARU | Legacy 4WD 2.0i 16V Turbo | 91    | 04 | ✓ |
| SUBARU | Legacy 4WD 2.5i 16V       | 96    | 04 | ✓ |
| SUBARU | Legacy IV                 | 09/03 | 06 | ✓ |

**972 715**

|        |                               |       |       |   |
|--------|-------------------------------|-------|-------|---|
| SUBARU | Justy 4WD                     | 10/95 | 04    | ✓ |
| SUZUKI | Baleno 4WD (EG)               | 95    | 04    | ✓ |
| SUZUKI | Cappucino                     | 92    | 95    | ✓ |
| SUZUKI | Liana 4WD (ER)                | 01    | 06    | ✓ |
| SUZUKI | Swift SF 413 4WD (AA35, AF35) | 89    | 03/96 | ✓ |
| SUZUKI | Swift SF 416 4WD (AJ14)       | 90    | 03/96 | ✓ |

**972 717**

|        |                                 |       |       |   |
|--------|---------------------------------|-------|-------|---|
| SUZUKI | Esteem                          | 06/89 | 92    | ✓ |
| SUZUKI | Swift SF 413 (AA35, AB35, AH35) | 89    | 03/96 | ✓ |
| SUZUKI | Swift SF 413 H (MAB35)          | 95    | 01    | ✓ |
| SUZUKI | Swift SF 413 GTI (AA34)         | 89    | 01    | ✓ |
| SUZUKI | Swift SF 416 (AH14)             | 89    | 03/96 | ✓ |

**972 719**

|        |                                 |    |       |   |
|--------|---------------------------------|----|-------|---|
| SUZUKI | Swift SF 310 H (MAA44)          | 95 | 01    | ✓ |
| SUZUKI | Swift SF 413 (AA35, AB35, AH35) | 89 | 03/96 | ✓ |
| SUZUKI | Swift SF 413 H (MAB35)          | 94 | 01    | ✓ |
| SUZUKI | Swift SF 413 Cabrio (AK35)      | 91 | 03/96 | ✓ |

**972 721**

|        |                                 |    |       |   |
|--------|---------------------------------|----|-------|---|
| SUZUKI | Swift SF 413 (AA35, AB35, AH35) | 89 | 03/96 | ✓ |
|--------|---------------------------------|----|-------|---|

**972 918**

|        |       |    |    |   |
|--------|-------|----|----|---|
| DAEWOO | Matiz | 98 | 05 | ✓ |
|--------|-------|----|----|---|

**972 973**

|        |                |    |    |   |
|--------|----------------|----|----|---|
| SUZUKI | Baleno (EG)    | 95 | 04 | ✓ |
| SUZUKI | Liana 2WD (ER) | 01 | 06 | ✓ |

**980 614**

|        |                                   |       |       |   |
|--------|-----------------------------------|-------|-------|---|
| TOYOTA | Camry 2.0i 16V (SV35)             | 07/90 | 04/94 | ✓ |
| TOYOTA | Camry 2.0i 16V (SV43)             | 06/94 | 00    | ✓ |
| TOYOTA | Celica 4WD 2.0i 16V Turbo (ST165) | 08/87 | 02/88 | ✓ |
| TOYOTA | Celica 4WD 2.0i 16V Turbo (ST185) | 10/89 | 04/91 | ✓ |

**981 149**

|        |               |       |    |   |
|--------|---------------|-------|----|---|
| TOYOTA | Corolla Verso | 06/04 | 06 | ✓ |
|--------|---------------|-------|----|---|

**981 199**

|        |                                    |       |       |   |
|--------|------------------------------------|-------|-------|---|
| TOYOTA | Celica 1.8i 16V (ZZT230, ZZT231)   | 11/99 | 04    | ✓ |
| TOYOTA | Corolla 1.4i 16V (ZZE120)          | 10/01 | 03    | ✓ |
| TOYOTA | Corolla 1.6i 16V (ZZE121)          | 10/01 | 03    | ✓ |
| TOYOTA | Corolla 1.8i 16V (ZZE123)          | 10/01 | 03    | ✓ |
| TOYOTA | Corolla 2.0 TDi 16V (CDE120)       | 10/01 | 03    | ✓ |
| TOYOTA | Corolla Verso 1.6 VVT-i 16V (E12J) | 02    | 04    | ✓ |
| TOYOTA | Corolla Verso 1.8 VVT-i 16V (E12J) | 02    | 04    | ✓ |
| TOYOTA | Corolla Verso 2.0 D-4D (E12J)      | 02    | 05/04 | ✓ |
| TOYOTA | Prius 1.5i 16V (NHW11)             | 05/00 | 01/04 | ✓ |

**981 203**

|        |                                    |       |       |   |
|--------|------------------------------------|-------|-------|---|
| TOYOTA | Corolla 1.4i 16V (EE111U)          | 09/98 | 09/01 | ✓ |
| TOYOTA | Corolla 1.4i 16V (ZZE111)          | 10/99 | 09/01 | ✓ |
| TOYOTA | Corolla 1.6i 16V (AE111U)          | 09/98 | 09/01 | ✓ |
| TOYOTA | Corolla 1.6i 16V (ZZE112)          | 10/99 | 09/01 | ✓ |
| TOYOTA | Corolla 2.0i Turbo Diesel (CDE110) | 08/00 | 09/01 | ✓ |

**981 283**

|        |                     |       |    |   |
|--------|---------------------|-------|----|---|
| TOYOTA | MR2 2.0i 16V (SW20) | 06/90 | 00 | ✓ |
|--------|---------------------|-------|----|---|

**981 407**

|        |                              |       |       |   |
|--------|------------------------------|-------|-------|---|
| TOYOTA | Carina E 1.6i 16V (AT190)    | 02/92 | 10/97 | ✓ |
| TOYOTA | Carina E 1.8i 16V (AT191)    | 11/92 | 10/97 | ✓ |
| TOYOTA | Carina E 2.0i 16V (ST191)    | 06/92 | 10/97 | ✓ |
| TOYOTA | Carina E 2.0i 16V GT (ST191) | 06/92 | 96    | ✓ |
| TOYOTA | Carina E 2.0 Diesel (CT190)  | 02/92 | 98    | ✓ |

**981 407**

|        |                                   |       |       |   |
|--------|-----------------------------------|-------|-------|---|
| TOYOTA | Carina E 2.0 Turbo Diesel (CT190) | 03/96 | 10/97 | ✓ |
| TOYOTA | Celica 1.6i 16V (AT180)           | 10/89 | 11/93 | ✓ |
| TOYOTA | Celica 1.8i 16V (AT200)           | 11/93 | 11/99 | ✓ |
| TOYOTA | Celica 2.0i 16V (ST182)           | 10/89 | 11/93 | ✓ |
| TOYOTA | Celica 2.0i 16V (ST202)           | 11/93 | 11/99 | ✓ |
| TOYOTA | Celica 4WD 2.0i 16V Turbo (ST185) | 10/89 | 04/91 | ✓ |
| TOYOTA | Celica 4WD 2.0i 16V Turbo (ST185) | 04/91 | 11/93 | ✓ |
| TOYOTA | RAV 4 I 2.0i 16V (SXA10/11)       | 04/94 | 00    | ✓ |

**981 447**

|        |                                    |       |       |   |
|--------|------------------------------------|-------|-------|---|
| TOYOTA | Celica 1.8 (RA60)                  | 08/81 | 07/85 | ✓ |
| TOYOTA | Celica 1.8 (RA63)                  | 08/81 | 89    | ✓ |
| TOYOTA | Celica 2.0 (RA61)                  | 08/81 | 85    | ✓ |
| TOYOTA | Celica 2.8 Supra (MA61)            | 08/81 | 85    | ✓ |
| TOYOTA | Corona (CT141)                     | 12/86 | 02/90 | ✓ |
| TOYOTA | Lite-Ace 1.5 (KM30G)               | 09/85 | 01/92 | ✓ |
| TOYOTA | Lite-Ace 1.5 (KM31V/36V)           | 09/85 | 01/92 | ✓ |
| TOYOTA | Lite-Ace 1.5 (KM51)                | 10/86 | 04/94 | ✓ |
| TOYOTA | Lite-Ace 1.5 (KR27)                | 92    | 01/94 | ✓ |
| TOYOTA | Lite-Ace 1.5 (KR41)                | 10/96 | 00    | ✓ |
| TOYOTA | Lite-Ace 1.8 (YM30G/31V)           | 09/85 | 01/91 | ✓ |
| TOYOTA | Lite-Ace 1.8 (YM55)                | 10/86 | 10/96 | ✓ |
| TOYOTA | Lite-Ace 1.8 (YR25)                | 92    | 01/94 | ✓ |
| TOYOTA | Lite-Ace 1.8 (KR42)                | 10/96 | 00    | ✓ |
| TOYOTA | Lite-Ace 2.0 (YR21G)               | 92    | 10/96 | ✓ |
| TOYOTA | Lite-Ace 2.0 Diesel (CR21G, CR27V) | 92    | 09/93 | ✓ |
| TOYOTA | Lite-Ace 2.0 Diesel (CM30G, CM31V) | 09/85 | 01/92 | ✓ |
| TOYOTA | Lite-Ace 2.0 Diesel (CM51)         | 10/86 | 09/96 | ✓ |
| TOYOTA | Lite-Ace 2.0 Diesel (CM55)         | 04/94 | 00    | ✓ |
| TOYOTA | Lite-Ace 2.2 Diesel (CR22G/29G)    | 09/93 | 09/96 | ✓ |

**981 475**

|        |                                  |       |       |   |
|--------|----------------------------------|-------|-------|---|
| LEXUS  | ES 300 (MCV20)                   | 96    | 00    | ✓ |
| LEXUS  | RX 300 (MCU10W, MCU15W)          | 98    | 03    | ✓ |
| TOYOTA | Avensis Verso                    | 05/01 | 04    | ✓ |
| TOYOTA | Camry 1.8i 16V (SV30, SV40)      | 07/90 | 00    | ✓ |
| TOYOTA | Camry 2.0i 16V (SV32, SV33)      | 07/90 | 94    | ✓ |
| TOYOTA | Camry 2.0i 16V (SV35)            | 07/90 | 04/94 | ✓ |
| TOYOTA | Camry 2.0i 16V (SV41, SV42)      | 06/94 | 00    | ✓ |
| TOYOTA | Camry 2.0i 16V (SV43)            | 06/94 | 00    | ✓ |
| TOYOTA | Camry 2.0 Turbo Diesel (CV30)    | 07/90 | 04/94 | ✓ |
| TOYOTA | Camry 2.2i 16V (SXV10)           | 07/91 | 96    | ✓ |
| TOYOTA | Camry 2.2i 16V (SXV20)           | 08/96 | 02    | ✓ |
| TOYOTA | Camry 2.2i 16V (SXV25W)          | 06/97 | 08/00 | ✓ |
| TOYOTA | Camry 2.4 VVT-i 16V (ACV30)      | 08/01 | 04    | ✓ |
| TOYOTA | Camry 2.5i V6 24V (MCV21)        | 08/99 | 00    | ✓ |
| TOYOTA | Camry 3.0i V6 24V (VCV10)        | 07/91 | 96    | ✓ |
| TOYOTA | Camry 3.0i V6 24V (MCV20)        | 08/96 | 01    | ✓ |
| TOYOTA | Camry 3.0i V6 24V (MCV30)        | 08/01 | 04    | ✓ |
| TOYOTA | Camry 4WD 2.2i 16V (SXV25)       | 08/99 | 00    | ✓ |
| TOYOTA | Camry Wagon 2.2i 16V (SXV10)     | 03/92 | 96    | ✓ |
| TOYOTA | Camry Wagon 3.0i V6 24V (VCV10)  | 06/92 | 07/01 | ✓ |
| TOYOTA | Picnic 2.0i 16V (SXM10)          | 09/95 | 02    | ✓ |
| TOYOTA | Picnic 2.2 Diesel (CXM10)        | 09/96 | 02    | ✓ |
| TOYOTA | RAV 4 II 1.8 VVTi (ZCA25/26)     | 05/00 | 05    | ✓ |
| TOYOTA | RAV 4 II 2.0 VVTi 4WD (ACA20/21) | 05/00 | 05    | ✓ |
| TOYOTA | RAV 4 II 2.0 D-4D 4WD (CLA20/21) | 05/01 | 05    | ✓ |

**981 499**

|        |  |    |       |   |
|--------|--|----|-------|---|
| TOYOTA | Landcruiser 2.4 Diesel (LJ70)          | 90 | 04/95 | ✓ |
| TOYOTA | Landcruiser 2.4 Turbo Diesel (LJ70/73) | 90 | 04/95 | ✓ |
| TOYOTA | Landcruiser 3.0 Turbo Diesel (KZJ70)   | 90 | 04/95 | ✓ |
| TOYOTA | Landcruiser 3.4 Diesel (BJJ73)         | 90 | 04/95 | ✓ |
| TOYOTA | Landcruiser 3.5 Diesel (PZJ7..)        | 90 | 04/95 | ✓ |
| TOYOTA | Landcruiser 4.0 (FJ80)                 | 90 | 03/93 | ✓ |
| TOYOTA | Landcruiser 4.2 Diesel (HZJ80)         | 90 | 94    | ✓ |
| TOYOTA | Landcruiser 4.2 Diesel (HZJ7..)        | 90 | 04/95 | ✓ |
| TOYOTA | Landcruiser 4.2 Turbo Diesel (HDJ80)   | 90 | 97    | ✓ |

**981 499**

|        |                      |         |    |    |   |  |
|--------|----------------------|---------|----|----|---|--|
| TOYOTA | Landcruiser 4.5i 24V | (FZJ80) | 90 | 98 | ✓ |  |
|--------|----------------------|---------|----|----|---|--|

**981 533**

|        |                              |          |    |       |   |  |
|--------|------------------------------|----------|----|-------|---|--|
| TOYOTA | Landcruiser 2.4              | (RJ70)   | 90 | 04/95 | ✓ |  |
| TOYOTA | Landcruiser 3.0 Turbo Diesel | (KZJ70)  | 90 | 04/95 | ✓ |  |
| TOYOTA | Landcruiser 3.4 Diesel       | (BJ73)   | 90 | 04/95 | ✓ |  |
| TOYOTA | Landcruiser 3.5 Diesel       | (PZJ7..) | 90 | 04/95 | ✓ |  |
| TOYOTA | Landcruiser 4.2 Diesel       | (HZJ80)  | 90 | 94    | ✓ |  |
| TOYOTA | Landcruiser 4.2 Diesel       | (HZJ7..) | 90 | 04/95 | ✓ |  |
| TOYOTA | Landcruiser 4.2 Turbo Diesel | (HDJ80)  | 90 | 97    | ✓ |  |

**981 572**

|        |                              |               |       |       |   |  |
|--------|------------------------------|---------------|-------|-------|---|--|
| TOYOTA | Camry 1.8                    | (SV10)        | 10/82 | 87    | ✓ |  |
| TOYOTA | Camry 1.8i                   | (SV20)        | 10/86 | 91    | ✓ |  |
| TOYOTA | Camry 1.8 Turbo Diesel       | (CV10)        | 08/83 | 87    | ✓ |  |
| TOYOTA | Camry 2.0i 16V               | (SV21)        | 08/86 | 91    | ✓ |  |
| TOYOTA | Camry 2.0 Turbo Diesel       | (CV11, CV20)  | 08/85 | 91    | ✓ |  |
| TOYOTA | Camry Wagon 2.0 Turbo Diesel | (CV20)        | 08/85 | 91    | ✓ |  |
| TOYOTA | Camry Wagon 2.5i V6 24V      | (VZV21)       | 90    | 94    | ✓ |  |
| TOYOTA | Carina II 1.6                | (AT151)       | 10/83 | 88    | ✓ |  |
| TOYOTA | Carina II 1.6 16V            | (AT171)       | 12/87 | 90    | ✓ |  |
| TOYOTA | Carina II 1.6i 16V           | (AT171)       | 12/87 | 92    | ✓ |  |
| TOYOTA | Carina II 1.8i               | (ST150)       | 09/85 | 92    | ✓ |  |
| TOYOTA | Carina II 2.0i 16V           | (ST171)       | 12/87 | 92    | ✓ |  |
| TOYOTA | Carina II 2.0 Diesel         | (CT150)       | 10/83 | 88    | ✓ |  |
| TOYOTA | Carina II 2.0 Diesel         | (CT170)       | 12/87 | 92    | ✓ |  |
| TOYOTA | Celica 1.6i 16V              | (AT160)       | 08/85 | 89    | ✓ |  |
| TOYOTA | Celica 1.8i 16V              | (AT200)       | 11/93 | 11/99 | ✓ |  |
| TOYOTA | Celica 2.0                   | (ST160)       | 08/85 | 08/87 | ✓ |  |
| TOYOTA | Celica 2.0i 16V              | (ST162)       | 08/87 | 02/89 | ✓ |  |
| TOYOTA | Celica 2.0i 16V              | (ST202)       | 11/93 | 11/99 | ✓ |  |
| TOYOTA | Celica 4WD 2.0i 16V Turbo    | (ST165)       | 08/87 | 02/88 | ✓ |  |
| TOYOTA | Corolla 1.3                  | (AE80)        | 05/83 | 07/87 | ✓ |  |
| TOYOTA | Corolla 1.6                  | (AE82)        | 05/83 | 07/87 | ✓ |  |
| TOYOTA | Corolla 1.8 Diesel           | (CE80)        | 05/83 | 07/87 | ✓ |  |
| TOYOTA | Corona FF                    | (AT151)       | 10/83 | 11/87 | ✓ |  |
| TOYOTA | Corona FF                    | (CT150,ST150) | 10/83 | 11/87 | ✓ |  |
| TOYOTA | RAV 4 I 2.0i 16V             | (SXA10/11)    | 04/94 | 00    | ✓ |  |

**981 616**



|        |                           |         |       |       |   |  |
|--------|---------------------------|---------|-------|-------|---|--|
| TOYOTA | Camry 2.0i                | (SV11)  | 06/84 | 88    | ✓ |  |
| TOYOTA | Camry 2.5i V6 24V         | (VZV21) | 02/88 | 91    | ✓ |  |
| TOYOTA | Camry 4WD 2.0i 16V        | (SV25)  | 08/88 | 91    | ✓ |  |
| TOYOTA | Camry Wagon 2.0i 16V      | (SV21)  | 08/86 | 91    | ✓ |  |
| TOYOTA | Carina E 1.6i 16V         | (AT190) | 02/92 | 10/97 | ✓ |  |
| TOYOTA | Carina E 1.8i 16V         | (AT191) | 11/92 | 10/97 | ✓ |  |
| TOYOTA | Carina E 2.0i 16V         | (ST191) | 06/92 | 10/97 | ✓ |  |
| TOYOTA | Carina E 2.0 Diesel       | (CT190) | 02/92 | 10/97 | ✓ |  |
| TOYOTA | Carina E 2.0 Turbo Diesel | (CT190) | 03/96 | 98    | ✓ |  |
| TOYOTA | Celica 1.6i 16V           | (AT180) | 10/89 | 11/93 | ✓ |  |
| TOYOTA | Celica 2.0i 16V           | (ST182) | 10/89 | 11/93 | ✓ |  |
| TOYOTA | Celica 4WD 2.0i 16V Turbo | (ST185) | 10/89 | 04/91 | ✓ |  |
| TOYOTA | Celica 4WD 2.0i 16V Turbo | (ST185) | 04/91 | 11/93 | ✓ |  |
| TOYOTA | MR2 1.6i 16V              | (AW11)  | 08/86 | 89    | ✓ |  |

**981 683**



|        |                     |             |       |       |   |  |
|--------|---------------------|-------------|-------|-------|---|--|
| TOYOTA | Lite-Ace 1.8        | (YM60,YM65) | 10/86 | 04/94 | ✓ |  |
| TOYOTA | Lite-Ace 2.0        | (YM40G)     | 10/85 | 01/92 | ✓ |  |
| TOYOTA | Lite-Ace 2.0        | (YR30G)     | 92    | 01/94 | ✓ |  |
| TOYOTA | Lite-Ace 2.0 Diesel | (CR30G/36G) | 92    | 01/94 | ✓ |  |
| TOYOTA | Lite-Ace 2.0 Diesel | (CR37G)     | 92    | 01/94 | ✓ |  |
| TOYOTA | Lite-Ace 2.0 Diesel | (CM40G/41V) | 09/85 | 01/92 | ✓ |  |
| TOYOTA | Lite-Ace 2.0 Diesel | (CM52)      | 10/91 | 04/94 | ✓ |  |
| TOYOTA | Lite-Ace 2.0 Diesel | (CM60,CM65) | 10/86 | 04/94 | ✓ |  |
| TOYOTA | Lite-Ace 2.0 Diesel | (CM61)      | 10/91 | 04/94 | ✓ |  |
| TOYOTA | Lite-Ace 2.2 Diesel | (CR31G/38G) | 09/93 | 01/94 | ✓ |  |

**981 690**



|        |             |        |       |       |   |  |
|--------|-------------|--------|-------|-------|---|--|
| TOYOTA | Corolla 1.3 | (EE90) | 08/87 | 06/91 | ✓ |  |
|--------|-------------|--------|-------|-------|---|--|

**981 690**



|        |                    |        |       |       |   |  |
|--------|--------------------|--------|-------|-------|---|--|
| TOYOTA | Corolla 1.6 16V    | (AE92) | 08/87 | 06/91 | ✓ |  |
| TOYOTA | Corolla 1.8 Diesel | (CE90) | 05/87 | 90    | ✓ |  |

**981 742**



|        |                |              |    |    |   |  |
|--------|----------------|--------------|----|----|---|--|
| TOYOTA | Tercel 1.3     | (AL20, AL21) | 82 | 84 | ✓ |  |
| TOYOTA | Tercel 1.5 4WD | (AL25)       | 82 | 88 | ✓ |  |

**981 743**



|        |                           |         |       |       |   |  |
|--------|---------------------------|---------|-------|-------|---|--|
| TOYOTA | Celica 2.0i 16V           | (ST202) | 11/93 | 11/99 | ✓ |  |
| TOYOTA | Celica 4WD 2.0i 16V Turbo | (ST205) | 02/94 | 11/99 | ✓ |  |

**981 744**



|        |                    |              |       |       |   |  |
|--------|--------------------|--------------|-------|-------|---|--|
| TOYOTA | Starlet 1.0        | (EP70)       | 84    | 89    | ✓ |  |
| TOYOTA | Starlet 1.0        | (EP80)       | 12/89 | 03/95 | ✓ |  |
| TOYOTA | Starlet 1.3        | (EP71)       | 10/84 | 89    | ✓ |  |
| TOYOTA | Starlet 1.3i       | (EP81, EP82) | 12/89 | 03/95 | ✓ |  |
| TOYOTA | Starlet 1.3i       | (EP85)       | 12/89 | 03/95 | ✓ |  |
| TOYOTA | Starlet 1.3i 16V   | (EP91,EP95)  | 11/95 | 99    | ✓ |  |
| TOYOTA | Starlet 1.5 Diesel | (NP70)       | 12/86 | 89    | ✓ |  |
| TOYOTA | Starlet 1.5 Diesel | (NP80)       | 12/89 | 03/95 | ✓ |  |
| TOYOTA | Starlet 1.5 Diesel | (NP90)       | 11/95 | 99    | ✓ |  |

**981 745**



|        |                 |         |       |       |   |  |
|--------|-----------------|---------|-------|-------|---|--|
| TOYOTA | Celica 2.0i 16V | (ST202) | 11/93 | 11/99 | ✓ |  |
|--------|-----------------|---------|-------|-------|---|--|

**981 747**



|        |                    |        |       |    |   |   |
|--------|--------------------|--------|-------|----|---|---|
| TOYOTA | Corolla 1.8 Diesel | (CE90) | 05/87 | 90 |   | ✓ |
| TOYOTA | MR2 1.6i 16V       | (AW11) | 11/84 | 89 | ✓ |   |

**981 763**



|        |                          |        |    |    |   |  |
|--------|--------------------------|--------|----|----|---|--|
| TOYOTA | Paseo Cabriolet 1.5i 16V | (EL54) | 95 | 00 | ✓ |  |
| TOYOTA | Paseo Coupé 1.5i 16V     | (EL44) | 94 | 00 | ✓ |  |

**981 790**



|          |                             |               |       |       |   |  |
|----------|-----------------------------|---------------|-------|-------|---|--|
| DAIHATSU | Charmant                    | (A35,A45,A60) | 81    | 86    | ✓ |  |
| TOYOTA   | Carina 1.5, 1.6, Celica 1.6 | (TA60)        | 08/81 | 07/85 | ✓ |  |
| TOYOTA   | Corolla                     | (AE71)        | 08/79 | 86    | ✓ |  |
| TOYOTA   | Corolla 1.3                 | (KE70)        | 80    | 05/83 | ✓ |  |
| TOYOTA   | Corolla 1.6, 1.6 GT         | (TE71)        | 80    | 05/83 | ✓ |  |
| TOYOTA   | Corolla 1.8                 | (TE72)        | 80    | 05/83 | ✓ |  |

**981 798**

|        |                  |               |       |       |   |  |
|--------|------------------|---------------|-------|-------|---|--|
| TOYOTA | Crown            | (MS122)       | 08/83 | 08/87 | ✓ |  |
| TOYOTA | Crown            | (LS120,YS120) | 08/83 | 08/87 | ✓ |  |
| TOYOTA | Crown            | (YS132)       | 09/87 | 08/89 | ✓ |  |
| TOYOTA | Crown            | (LS130,MS130) | 09/87 | 08/89 | ✓ |  |
| TOYOTA | Crown            | (MS123/125)   | 08/83 | 08/87 | ✓ |  |
| TOYOTA | Crown 2.0        | (GS130)       | 90    | 98    | ✓ |  |
| TOYOTA | Crown 2.0        | (GS131/141)   | 09/87 | 11/93 | ✓ |  |
| TOYOTA | Crown 2.0        | (YS130)       | 12/91 | 96    | ✓ |  |
| TOYOTA | Crown 2.0 Diesel | (LS130G)      | 09/87 | 10/91 | ✓ |  |
| TOYOTA | Crown 2.4 Diesel | (LS130/131)   | 09/89 | 11/93 | ✓ |  |
| TOYOTA | Crown 2.4 Diesel | (LS136V/141)  | 09/89 | 11/93 | ✓ |  |
| TOYOTA | Crown 2.5        | (JZS130G/131) | 08/90 | 11/93 | ✓ |  |
| TOYOTA | Crown 2.5        | (JZS141)      | 10/91 | 11/93 | ✓ |  |
| TOYOTA | Crown 3.0        | (JZS133/135)  | 10/91 | 11/93 | ✓ |  |
| TOYOTA | Crown 3.0        | (JZS143/145)  | 10/91 | 11/93 | ✓ |  |

**981 805**

|        |                         |                |       |       |   |  |
|--------|-------------------------|----------------|-------|-------|---|--|
| LEXUS  | GS 300                  | (JZS147)       | 93    | 07/97 | ✓ |  |
| LEXUS  | LS 400                  | (UCF10)        | 89    | 94    | ✓ |  |
| LEXUS  | LS 400                  | (UCF20, UCF21) | 94    | 00    | ✓ |  |
| TOYOTA | Supra 2.0i 16V          | (GA70)         | 86    | 05/93 | ✓ |  |
| TOYOTA | Supra 2.5i 16V          | (JA70)         | 08/90 | 05/93 | ✓ |  |
| TOYOTA | Supra 3.0i V6 24V       | (MA70)         | 86    | 92    | ✓ |  |
| TOYOTA | Supra 3.0i V6 24V Turbo | (MA70)         | 87    | 93    | ✓ |  |
| TOYOTA | Supra 3.0i V6 24V Turbo | (JA80)         | 05/93 | 07/96 | ✓ |  |

**981 814**

|        |                 |        |       |       |   |  |
|--------|-----------------|--------|-------|-------|---|--|
| TOYOTA | Carina 1.6 DOHC | (AA63) | 08/83 | 07/85 | ✓ |  |
|--------|-----------------|--------|-------|-------|---|--|

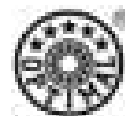

**981 814**

|        |                     |              |       |       |   |
|--------|---------------------|--------------|-------|-------|---|
| TOYOTA | Carina 1.8          | (RA60, RA63) | 08/81 | 07/85 | ✓ |
| TOYOTA | Carina 2.0          | (RA61)       | 08/81 | 07/85 | ✓ |
| TOYOTA | Celica 1.6          | (AA63)       | 08/83 | 07/85 | ✓ |
| TOYOTA | Celica 1.6          | (AT160)      | 08/83 | 89    | ✓ |
| TOYOTA | Cressida 1.8        | (YX76V)      | 11/84 | 02/93 | ✓ |
| TOYOTA | Cressida 2.0        | (YX78V)      | 02/93 | 02/94 | ✓ |
| TOYOTA | Cressida 2.4 Diesel | (LX76V)      | 11/84 | 02/94 | ✓ |
| TOYOTA | Lite-Ace 1.3        | (KM20)       | 10/79 | 01/85 | ✓ |
| TOYOTA | Lite-Ace 1.8        | (CM20)       | 83    | 01/85 | ✓ |

**981 824**

|        |                                    |  |       |    |   |
|--------|------------------------------------|--|-------|----|---|
| TOYOTA | Yaris 1.0i VVT-i, 1.3i VVT-i, D-4D |  | 01/06 | 06 | ✓ |
|--------|------------------------------------|--|-------|----|---|

**981 849**

|       |        |         |    |    |   |
|-------|--------|---------|----|----|---|
| LEXUS | IS 200 | (GXE10) | 99 | 04 | ✓ |
|-------|--------|---------|----|----|---|

**981 851**

|        |                          |              |       |       |   |
|--------|--------------------------|--------------|-------|-------|---|
| TOYOTA | Paseo Cabriolet 1.5i 16V | (EL54)       | 95    | 00    | ✓ |
| TOYOTA | Paseo Coupé 1.5i 16V     | (EL44)       | 94    | 00    | ✓ |
| TOYOTA | Tercel 1.3               | (EL41)       | 09/90 | 02/94 | ✓ |
| TOYOTA | Tercel 1.3               | (EL51)       | 04/94 | 98    | ✓ |
| TOYOTA | Tercel 1.5               | (EL42)       | 09/90 | 10/92 | ✓ |
| TOYOTA | Tercel 1.5               | (EL43, EL45) | 09/90 | 08/94 | ✓ |
| TOYOTA | Tercel 1.5               | (EL53, EL55) | 09/94 | 98    | ✓ |
| TOYOTA | Tercel 1.5 Diesel        | (NL40)       | 09/90 | 08/94 | ✓ |
| TOYOTA | Tercel 1.5 Diesel        | (NL50)       | 09/94 | 98    | ✓ |

**981 856**

|        |                    |             |       |       |   |
|--------|--------------------|-------------|-------|-------|---|
| TOYOTA | Corolla 1.4i 16V   | (EE101)     | 05/92 | 04/97 | ✓ |
| TOYOTA | Corolla 1.4i 16V   | (EE110/111) | 05/92 | 08/98 | ✓ |
| TOYOTA | Corolla 1.5i 16V   | (AE110)     | 05/95 | 98    | ✓ |
| TOYOTA | Corolla 1.6i 16V   | (AE100-111) | 05/92 | 08/98 | ✓ |
| TOYOTA | Corolla 2.0 Diesel | (CE100/110) | 05/92 | 07/00 | ✓ |

**981 868**

|        |                    |             |       |       |   |
|--------|--------------------|-------------|-------|-------|---|
| TOYOTA | Corolla 1.4i 16V   | (EE101)     | 05/92 | 04/97 | ✓ |
| TOYOTA | Corolla 1.4i 16V   | (EE110/111) | 05/92 | 08/98 | ✓ |
| TOYOTA | Corolla 1.5i 16V   | (AE110)     | 05/95 | 98    | ✓ |
| TOYOTA | Corolla 1.6i 16V   | (AE100-111) | 05/92 | 08/98 | ✓ |
| TOYOTA | Corolla 2.0 Diesel | (CE100/110) | 05/92 | 07/00 | ✓ |

**981 938**

|        |                           |            |    |       |   |
|--------|---------------------------|------------|----|-------|---|
| TOYOTA | Yaris 1.0i 16V            | (CP10)     | 99 | 05    | ✓ |
| TOYOTA | Yaris 1.3i 16V            | (CP10/11)  | 99 | 12/05 | ✓ |
| TOYOTA | Yaris 1.4 D-4D, 1.5 VVT-i | (CP10/11)  | 01 | 05    | ✓ |
| TOYOTA | Yaris 1.5 TS              | (CP10/11)  | 03 | 05    | ✓ |
| TOYOTA | Yaris Verso 1.3i 16V      | (NCP20)    | 99 | 05    | ✓ |
| TOYOTA | Yaris Verso 1.4 D-4D      | (NLP20/22) | 01 | 05    | ✓ |
| TOYOTA | Yaris Verso 1.5 VVT-i     | (NCP21)    | 00 | 05    | ✓ |

**981 944**

|        |                     |          |    |       |   |
|--------|---------------------|----------|----|-------|---|
| TOYOTA | Previa 2.4i 16V     | (TCR1/2) | 90 | 08/00 | ✓ |
| TOYOTA | Previa 2.4i 16V 4WD | (TCR1/2) | 90 | 08/00 | ✓ |

**981 947**

|        |                                |       |       |    |   |
|--------|--------------------------------|-------|-------|----|---|
| TOYOTA | Avensis, Avensis Station Wagon | (T22) | 10/97 | 04 | ✓ |
| TOYOTA | Avensis, Avensis Station Wagon | (T25) | 04/03 | 05 | ✓ |

**981 952**

|        |                             |            |       |    |   |
|--------|-----------------------------|------------|-------|----|---|
| TOYOTA | Hi-Lux 4-Runner 2.7i 16V    | (RZN85W)   | 11/95 | 03 | ✓ |
| TOYOTA | Hi-Lux 4-Runner 2.7i 16V    | (RZN180)   | 11/95 | 03 | ✓ |
| TOYOTA | Hi-Lux 4-Runner 3.0 D       | (KZN85G)   | 11/95 | 03 | ✓ |
| TOYOTA | Hi-Lux 4-Runner 3.0 D       | (KZN85W)   | 11/95 | 03 | ✓ |
| TOYOTA | Hi-Lux 4-Runner 3.4i V6 24V | (VZN85)    | 11/95 | 03 | ✓ |
| TOYOTA | Hi-Lux 4-Runner 3.4i V6 24V | (VZN180)   | 11/95 | 03 | ✓ |
| TOYOTA | Landcruiser 3.0 Turbo D.    | (KZJ90/95) | 04/96 | 03 | ✓ |
| TOYOTA | Landcruiser 3.4i 24V        | (VZJ90/95) | 04/96 | 03 | ✓ |

**981 966**

|        |                              |          |    |    |   |
|--------|------------------------------|----------|----|----|---|
| TOYOTA | Landcruiser 4.2 Turbo Diesel | (HDJ100) | 98 | 03 | ✓ |
|--------|------------------------------|----------|----|----|---|

**981 966**

|        |                         |          |    |    |   |
|--------|-------------------------|----------|----|----|---|
| TOYOTA | Landcruiser 4.7i V8 32V | (UZJ100) | 98 | 03 | ✓ |
|--------|-------------------------|----------|----|----|---|

**982 195**

|        |                                    |            |       |       |   |
|--------|------------------------------------|------------|-------|-------|---|
| TOYOTA | Yaris 1.0i 16V                     | (CP10)     | 99    | 05    | ✓ |
| TOYOTA | Yaris 1.0i VVT-i, 1.3i VVT-i, D-4D |            | 01/06 | 06    | ✓ |
| TOYOTA | Yaris 1.3i 16V                     | (CP10/11)  | 99    | 12/05 | ✓ |
| TOYOTA | Yaris 1.4 D-4D, 1.5 VVT-i          | (CP10/11)  | 01    | 05    | ✓ |
| TOYOTA | Yaris 1.5 TS                       | (CP10/11)  | 03    | 05    | ✓ |
| TOYOTA | Yaris Verso 1.3i 16V               | (NCP20)    | 99    | 05    | ✓ |
| TOYOTA | Yaris Verso 1.4 D-4D               | (NLP20/22) | 01    | 05    | ✓ |
| TOYOTA | Yaris Verso 1.5 VVT-i              | (NCP21)    | 00    | 05    | ✓ |

**982 201**

|        |                    |             |       |       |   |
|--------|--------------------|-------------|-------|-------|---|
| TOYOTA | Corolla 1.4i 16V   | (EE101)     | 05/92 | 04/97 | ✓ |
| TOYOTA | Corolla 1.4i 16V   | (EE110/111) | 05/92 | 08/98 | ✓ |
| TOYOTA | Corolla 1.6i 16V   | (AE100-111) | 05/92 | 08/98 | ✓ |
| TOYOTA | Corolla 2.0 Diesel | (CE100/110) | 05/92 | 07/00 | ✓ |

**982 225**

|        |                           |         |       |       |   |
|--------|---------------------------|---------|-------|-------|---|
| TOYOTA | Carina E 1.6i 16V         | (AT190) | 02/92 | 10/97 | ✓ |
| TOYOTA | Carina E 1.8i 16V         | (AT191) | 11/92 | 10/97 | ✓ |
| TOYOTA | Carina E 2.0i 16V         | (ST191) | 06/92 | 10/97 | ✓ |
| TOYOTA | Carina E 2.0i 16V GT      | (ST191) | 06/92 | 96    | ✓ |
| TOYOTA | Carina E 2.0 Diesel       | (CT190) | 02/92 | 98    | ✓ |
| TOYOTA | Carina E 2.0 Turbo Diesel | (CT190) | 03/96 | 10/97 | ✓ |

**982 287**

|        |               |            |       |    |   |
|--------|---------------|------------|-------|----|---|
| TOYOTA | Hi-Ace 2.4i   | (RCH12)    | 08/95 | 04 | ✓ |
| TOYOTA | Hi-Ace 2.4 D  | (LXH12/22) | 08/95 | 04 | ✓ |
| TOYOTA | Hi-Ace 2.4 TD | (LXH12/22) | 08/95 | 04 | ✓ |
| TOYOTA | Hi-Ace 2.7i   | (RCH13)    | 04/98 | 04 | ✓ |

**982 288**

|        |                              |          |    |    |   |
|--------|------------------------------|----------|----|----|---|
| TOYOTA | Landcruiser 4.2 Turbo Diesel | (HDJ100) | 98 | 03 | ✓ |
| TOYOTA | Landcruiser 4.7i V8 32V      | (UZJ100) | 98 | 03 | ✓ |

**982 289**

|        |              |        |       |    |   |
|--------|--------------|--------|-------|----|---|
| TOYOTA | MR2 2.0i 16V | (SW20) | 06/90 | 00 | ✓ |
|--------|--------------|--------|-------|----|---|

**982 373**

|        |                  |              |       |       |   |
|--------|------------------|--------------|-------|-------|---|
| TOYOTA | Carina 1.6 DOHC  | (AA63)       | 08/83 | 07/85 | ✓ |
| TOYOTA | Carina 1.8       | (RA60, RA63) | 08/81 | 07/85 | ✓ |
| TOYOTA | Carina 2.0       | (RA61)       | 08/81 | 07/85 | ✓ |
| TOYOTA | Celica 1.6       | (AA63)       | 08/83 | 07/85 | ✓ |
| TOYOTA | Celica 1.6       | (AT160)      | 08/83 | 89    | ✓ |
| TOYOTA | Celica 1.8       | (RA63)       | 06/83 | 89    | ✓ |
| TOYOTA | Celica 2.0       | (RA61)       | 06/83 | 85    | ✓ |
| TOYOTA | Celica 2.8 Supra | (MA61)       | 06/83 | 85    | ✓ |
| TOYOTA | Crown            | (MS123/125)  | 08/83 | 08/87 | ✓ |

**982 379**

|        |                           |         |       |       |   |
|--------|---------------------------|---------|-------|-------|---|
| TOYOTA | Carina E 1.6i 16V         | (AT190) | 02/92 | 10/97 | ✓ |
| TOYOTA | Carina E 1.8i 16V         | (AT191) | 11/92 | 10/97 | ✓ |
| TOYOTA | Carina E 2.0i 16V         | (ST191) | 06/92 | 10/97 | ✓ |
| TOYOTA | Carina E 2.0 Diesel       | (CT190) | 02/92 | 10/97 | ✓ |
| TOYOTA | Carina E 2.0 Turbo Diesel | (CT190) | 03/96 | 98    | ✓ |
| TOYOTA | Celica 1.8i 16V           | (AT200) | 11/93 | 11/99 | ✓ |
| TOYOTA | Celica 2.0i 16V           | (ST202) | 11/93 | 11/99 | ✓ |

**982 431**

|        |                              |                  |       |       |   |
|--------|------------------------------|------------------|-------|-------|---|
| LEXUS  | RX 300                       | (MCU10W, MCU15W) | 98    | 03    | ✓ |
| TOYOTA | Camry 2.2i 16V               | (SXV10)          | 07/91 | 96    | ✓ |
| TOYOTA | Camry 2.2i 16V               | (SXV20)          | 08/96 | 08/00 | ✓ |
| TOYOTA | Camry 2.2i 16V               | (SXV25W)         | 06/97 | 08/00 | ✓ |
| TOYOTA | Camry 2.5i V6 24V            | (MCV21)          | 08/99 | 00    | ✓ |
| TOYOTA | Camry 3.0i V6 24V            | (VCV10)          | 07/91 | 96    | ✓ |
| TOYOTA | Camry 3.0i V6 24V            | (MCV20)          | 08/96 | 07/99 | ✓ |
| TOYOTA | Camry 4WD 2.2i 16V           | (SXV25)          | 08/99 | 00    | ✓ |
| TOYOTA | Camry Wagon 2.0i 16V         | (SV21)           | 08/86 | 91    | ✓ |
| TOYOTA | Camry Wagon 2.0 Turbo Diesel | (CV20)           | 08/85 | 91    | ✓ |



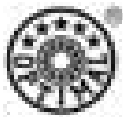

# OPTIMAL

## SATZ-VERZEICHNIS KITS INDEX INDEX DES KITS

### 982 431

|        |                         |         |       |       |  |   |
|--------|-------------------------|---------|-------|-------|--|---|
| TOYOTA | Camry Wagon 2.2i 16V    | (SXV10) | 03/92 | 96    |  | ✓ |
| TOYOTA | Camry Wagon 3.0i V6 24V | (VCV10) | 06/92 | 07/01 |  | ✓ |

### 982 559

|        |                         |                |       |       |  |   |
|--------|-------------------------|----------------|-------|-------|--|---|
| LEXUS  | GS 300                  | (JZS147)       | 93    | 07/97 |  | ✓ |
| LEXUS  | LS 400                  | (UCF10)        | 89    | 94    |  | ✓ |
| LEXUS  | LS 400                  | (UCF20, UCF21) | 94    | 00    |  | ✓ |
| TOYOTA | Cressida 1.8            | (SX90)         | 10/92 | 04/94 |  | ✓ |
| TOYOTA | Cressida 2.0            | (GX81)         | 08/88 | 10/93 |  | ✓ |
| TOYOTA | Cressida 2.0            | (GX90)         | 10/92 | 04/94 |  | ✓ |
| TOYOTA | Cressida 2.0            | (GX100)        | 09/96 | 00    |  | ✓ |
| TOYOTA | Cressida 2.4 Diesel     | (LX90)         | 10/92 | 04/94 |  | ✓ |
| TOYOTA | Cressida 2.4 Diesel     | (LX100)        | 09/96 | 00    |  | ✓ |
| TOYOTA | Cressida 2.5            | (JZX81)        | 08/90 | 02/93 |  | ✓ |
| TOYOTA | Cressida 2.5            | (JZX90, JZX93) | 10/93 | 04/94 |  | ✓ |
| TOYOTA | Cressida 2.5            | (JZX100/105)   | 09/96 | 00    |  | ✓ |
| TOYOTA | Cressida 3.0            | (MX83)         | 08/88 | 02/93 |  | ✓ |
| TOYOTA | Cressida 3.0            | (MX91)         | 10/92 | 04/94 |  | ✓ |
| TOYOTA | Cressida 3.0            | (MX101)        | 09/96 | 00    |  | ✓ |
| TOYOTA | Supra 2.0i 16V          | (GA70)         | 86    | 05/93 |  | ✓ |
| TOYOTA | Supra 2.5i 16V          | (JZA70)        | 08/90 | 05/93 |  | ✓ |
| TOYOTA | Supra 3.0i V6 24V       | (MA70)         | 86    | 92    |  | ✓ |
| TOYOTA | Supra 3.0i V6 24V Turbo | (MA70)         | 87    | 93    |  | ✓ |
| TOYOTA | Supra 3.0i V6 24V Turbo | (JZA80)        | 05/93 | 07/96 |  | ✓ |

### 982 561

|        |                          |                    |       |       |  |   |
|--------|--------------------------|--------------------|-------|-------|--|---|
| TOYOTA | Paseo Cabriolet 1.5i 16V | (EL54)             | 95    | 00    |  | ✓ |
| TOYOTA | Paseo Coupé 1.5i 16V     | (EL44)             | 94    | 00    |  | ✓ |
| TOYOTA | Starlet 1.0              | (EP80)             | 12/89 | 03/95 |  | ✓ |
| TOYOTA | Starlet 1.3i             | (EP81, EP82, EP85) | 12/89 | 03/95 |  | ✓ |
| TOYOTA | Starlet 1.3i 16V         | (EP91, EP95)       | 11/95 | 99    |  | ✓ |
| TOYOTA | Starlet 1.5 Diesel       | (NP80)             | 12/89 | 03/95 |  | ✓ |
| TOYOTA | Starlet 1.5 Diesel       | (NP90)             | 11/95 | 99    |  | ✓ |
| TOYOTA | Tercel 1.3               | (EL41)             | 09/90 | 02/94 |  | ✓ |
| TOYOTA | Tercel 1.5               | (EL42)             | 09/90 | 10/92 |  | ✓ |
| TOYOTA | Tercel 1.5               | (EL43)             | 09/90 | 08/94 |  | ✓ |
| TOYOTA | Tercel 1.5 Diesel        | (NL40)             | 09/90 | 08/94 |  | ✓ |

### 982 581

|        |                          |                 |       |       |  |   |
|--------|--------------------------|-----------------|-------|-------|--|---|
| TOYOTA | Landcruiser 3.4 Diesel   | (BJ4../6../7..) | 80    | 89    |  | ✓ |
| TOYOTA | Landcruiser 3.4 Diesel   | (BJ73)          | 90    | 04/95 |  | ✓ |
| TOYOTA | Landcruiser 3.4 Turbo D. | (BJ4../6../7..) | 80    | 89    |  | ✓ |
| TOYOTA | Landcruiser 3.5 Diesel   | (PZJ7..)        | 90    | 04/95 |  | ✓ |
| TOYOTA | Landcruiser 4.0          | (FJ80)          | 90    | 94    |  | ✓ |
| TOYOTA | Landcruiser 4.0 Diesel   | (HJ60)          | 80    | 89    |  | ✓ |
| TOYOTA | Landcruiser 4.0 Turbo D. | (HJ61)          | 80    | 89    |  | ✓ |
| TOYOTA | Landcruiser 4.2 Diesel   | (HZJ80)         | 90    | 94    |  | ✓ |
| TOYOTA | Landcruiser 4.2 Diesel   | (HZJ7..)        | 90    | 04/95 |  | ✓ |
| TOYOTA | Landcruiser 4.2 Turbo D. | (HDJ80)         | 90    | 97    |  | ✓ |
| TOYOTA | Landcruiser 4.3          | (FJ40)          | 80    | 87    |  | ✓ |
| TOYOTA | Landcruiser 4.3          | (FJ62)          | 08/87 | 02/89 |  | ✓ |
| TOYOTA | Landcruiser 4.5i 24V     | (FZJ80)         | 90    | 98    |  | ✓ |
| TOYOTA | Toyo-Ace                 | (RY20, RY30)    | 03/79 | 07/85 |  | ✓ |

### 982 685

|        |                     |              |       |       |  |   |
|--------|---------------------|--------------|-------|-------|--|---|
| TOYOTA | Lite-Ace 1.5        | (KM30G)      | 09/85 | 01/92 |  | ✓ |
| TOYOTA | Lite-Ace 1.5        | (KM31V/36V)  | 09/85 | 01/92 |  | ✓ |
| TOYOTA | Lite-Ace 1.5        | (KR41)       | 10/96 | 00    |  | ✓ |
| TOYOTA | Lite-Ace 1.8        | (YM30G/31V)  | 09/85 | 01/91 |  | ✓ |
| TOYOTA | Lite-Ace 1.8        | (YM55)       | 10/86 | 10/96 |  | ✓ |
| TOYOTA | Lite-Ace 1.8        | (YM60, YM65) | 10/86 | 04/94 |  | ✓ |
| TOYOTA | Lite-Ace 1.8        | (KR42)       | 10/96 | 00    |  | ✓ |
| TOYOTA | Lite-Ace 2.0        | (YM40G)      | 10/85 | 01/92 |  | ✓ |
| TOYOTA | Lite-Ace 2.0        | (YR21G)      | 92    | 10/96 |  | ✓ |
| TOYOTA | Lite-Ace 2.0        | (YR30G)      | 92    | 01/94 |  | ✓ |
| TOYOTA | Lite-Ace 2.0 Diesel | (CR30G/36G)  | 92    | 01/94 |  | ✓ |
| TOYOTA | Lite-Ace 2.0 Diesel | (CR37G)      | 92    | 01/94 |  | ✓ |
| TOYOTA | Lite-Ace 2.0 Diesel | (CM31V/36V)  | 09/85 | 01/92 |  | ✓ |

### 982 685

|        |                     |              |       |       |  |   |
|--------|---------------------|--------------|-------|-------|--|---|
| TOYOTA | Lite-Ace 2.0 Diesel | (CM40G/41V)  | 09/85 | 01/92 |  | ✓ |
| TOYOTA | Lite-Ace 2.0 Diesel | (CM60, CM65) | 10/86 | 04/94 |  | ✓ |
| TOYOTA | Lite-Ace 2.2 Diesel | (CR31G/38G)  | 09/93 | 01/94 |  | ✓ |

### 982 737

|        |                           |         |       |       |  |   |
|--------|---------------------------|---------|-------|-------|--|---|
| TOYOTA | Celica 4WD 2.0i 16V Turbo | (ST185) | 04/91 | 11/93 |  | ✓ |
| TOYOTA | Celica 4WD 2.0i 16V Turbo | (ST205) | 02/94 | 11/99 |  | ✓ |

### 982 762

|        |                  |            |       |    |  |   |
|--------|------------------|------------|-------|----|--|---|
| TOYOTA | RAV 4 I 2.0i 16V | (SXA10/11) | 04/94 | 00 |  | ✓ |
|--------|------------------|------------|-------|----|--|---|

### 982 764

|        |                      |              |       |       |  |   |
|--------|----------------------|--------------|-------|-------|--|---|
| TOYOTA | Carina 1.5, 1.6, 1.8 | (TA60, RA60) | 08/81 | 07/85 |  | ✓ |
| TOYOTA | Celica 1.6, 1.8      | (TA60, RA60) | 08/81 | 07/85 |  | ✓ |
| TOYOTA | Corolla 1.6 GT, 1.8  | (TE71, TE72) | 80    | 05/83 |  | ✓ |
| TOYOTA | Corona               | (CT141)      | 12/86 | 02/90 |  | ✓ |
| TOYOTA | Cressida 1.8         | (YX76V)      | 11/84 | 02/93 |  | ✓ |
| TOYOTA | Cressida 1.8         | (SX80)       | 08/88 | 10/93 |  | ✓ |
| TOYOTA | Cressida 2.0         | (GX70G)      | 11/84 | 02/94 |  | ✓ |
| TOYOTA | Cressida 2.0         | (YX78V)      | 02/93 | 02/94 |  | ✓ |
| TOYOTA | Cressida 2.0         | (YX80Y)      | 08/88 | 10/93 |  | ✓ |
| TOYOTA | Cressida 2.4 Diesel  | (LX76V)      | 11/84 | 02/94 |  | ✓ |
| TOYOTA | Cressida 2.4 Diesel  | (LX80)       | 08/88 | 02/93 |  | ✓ |
| TOYOTA | Lite-Ace 1.3         | (KM20)       | 10/79 | 01/85 |  | ✓ |
| TOYOTA | Lite-Ace 1.5         | (KR27)       | 92    | 01/94 |  | ✓ |
| TOYOTA | Lite-Ace 1.8         | (CM20)       | 83    | 01/85 |  | ✓ |
| TOYOTA | Lite-Ace 1.8         | (YR25)       | 92    | 01/94 |  | ✓ |
| TOYOTA | Lite-Ace 2.0 Diesel  | (CR21G)      | 92    | 09/93 |  | ✓ |
| TOYOTA | Lite-Ace 2.0 Diesel  | (CR27V/28G)  | 92    | 09/93 |  | ✓ |
| TOYOTA | Lite-Ace 2.2 Diesel  | (CR22G/29G)  | 09/93 | 09/96 |  | ✓ |

### 982 766

|        |                         |                       |       |       |  |   |
|--------|-------------------------|-----------------------|-------|-------|--|---|
| TOYOTA | Camry 1.8               | (SV10)                | 10/82 | 87    |  | ✓ |
| TOYOTA | Camry 1.8i              | (SV20)                | 10/86 | 91    |  | ✓ |
| TOYOTA | Camry 1.8 Turbo Diesel  | (CV10)                | 08/83 | 87    |  | ✓ |
| TOYOTA | Camry 2.0i              | (SV11)                | 06/84 | 88    |  | ✓ |
| TOYOTA | Camry 2.0i 16V          | (SV21)                | 08/86 | 91    |  | ✓ |
| TOYOTA | Camry 2.0 Turbo Diesel  | (CV11, CV20)          | 08/85 | 91    |  | ✓ |
| TOYOTA | Camry 2.0 Turbo Diesel  | (CV30)                | 07/90 | 04/94 |  | ✓ |
| TOYOTA | Camry 2.5i V6 24V       | (VZV21)               | 02/88 | 91    |  | ✓ |
| TOYOTA | Camry 4WD 2.0i 16V      | (SV25)                | 08/88 | 91    |  | ✓ |
| TOYOTA | Camry Wagon 2.5i V6 24V | (VZV21)               | 90    | 94    |  | ✓ |
| TOYOTA | Carina II 1.6           | (AT151)               | 10/83 | 88    |  | ✓ |
| TOYOTA | Carina II 1.6 16V       | (AT171)               | 12/87 | 90    |  | ✓ |
| TOYOTA | Carina II 1.6i 16V      | (AT171)               | 12/87 | 92    |  | ✓ |
| TOYOTA | Carina II 1.8i          | (ST150)               | 09/85 | 92    |  | ✓ |
| TOYOTA | Carina II 2.0i 16V      | (ST171)               | 12/87 | 92    |  | ✓ |
| TOYOTA | Carina II 2.0 Diesel    | (CT150)               | 10/83 | 88    |  | ✓ |
| TOYOTA | Carina II 2.0 Diesel    | (CT170)               | 12/87 | 92    |  | ✓ |
| TOYOTA | Celica 1.6i 16V         | (AT160)               | 08/85 | 89    |  | ✓ |
| TOYOTA | Celica 1.6i 16V         | (AT180)               | 10/89 | 11/93 |  | ✓ |
| TOYOTA | Celica 2.0              | (ST160)               | 08/85 | 08/87 |  | ✓ |
| TOYOTA | Celica 2.0i 16V         | (ST162)               | 08/87 | 02/89 |  | ✓ |
| TOYOTA | Celica 2.0i 16V         | (ST182)               | 10/89 | 11/93 |  | ✓ |
| TOYOTA | Corona FF               | (CT150, ST150, AT151) | 10/83 | 11/87 |  | ✓ |

### 982 774

|        |                  |              |       |       |  |   |
|--------|------------------|--------------|-------|-------|--|---|
| TOYOTA | Hi-Ace 2.0i      | (RZH102/112) | 08/89 | 08/95 |  | ✓ |
| TOYOTA | Hi-Ace 2.4i      | (RZH103/113) | 08/89 | 08/95 |  | ✓ |
| TOYOTA | Hi-Ace 2.4 D     | (LH51/61)    | 84    | 88    |  | ✓ |
| TOYOTA | Hi-Ace 2.4 D     | (LH102/112)  | 08/89 | 08/95 |  | ✓ |
| TOYOTA | Hi-Ace 2.4 TD    | (LH51/61)    | 87    | 95    |  | ✓ |
| TOYOTA | Hi-Ace 3.0i      | (KZH100)     | 05/95 | 99    |  | ✓ |
| TOYOTA | Hi-Ace 3.0i      | (KZH110/120) | 05/95 | 99    |  | ✓ |
| TOYOTA | Hi-Lux 2WD 1.8   | (YN85, YN90) | 08/88 | 05/94 |  | ✓ |
| TOYOTA | Hi-Lux 2WD 2.4   | (RN58)       | 07/94 | 98    |  | ✓ |
| TOYOTA | Hi-Lux 2WD 2.4 D | (LN85, LN90) | 08/88 | 08/97 |  | ✓ |
| TOYOTA | Hi-Lux 2WD 2.8 D | (LN57)       | 08/95 | 98    |  | ✓ |

**982 778**

|        |                      |              |       |       |   |
|--------|----------------------|--------------|-------|-------|---|
| TOYOTA | Corolla 1.3, 1.6     | (AE80, AE82) | 05/83 | 07/87 | ✓ |
| TOYOTA | Corolla 1.3, 1.6 16V | (EE90, AE92) | 08/87 | 06/91 | ✓ |
| TOYOTA | Corolla 1.8 Diesel   | (CE80, CE90) | 05/83 | 90    | ✓ |

**982 780**

|        |                    |              |       |       |   |
|--------|--------------------|--------------|-------|-------|---|
| TOYOTA | Corolla 1.3        | (AE80, EE90) | 05/83 | 06/91 | ✓ |
| TOYOTA | Corolla 1.6        | (AE82)       | 05/83 | 07/87 | ✓ |
| TOYOTA | Corolla 1.6 16V    | (AE92)       | 08/87 | 06/91 | ✓ |
| TOYOTA | Corolla 1.8 Diesel | (CE80)       | 05/83 | 07/87 | ✓ |

**982 782**

|        |                                      |                  |       |       |   |
|--------|--------------------------------------|------------------|-------|-------|---|
| TOYOTA | Avensis, Avensis Station Wagon (T25) |                  | 04/03 | 05    | ✓ |
| TOYOTA | Celica 1.8i 16V                      | (ZZT230, ZZT231) | 11/99 | 04    | ✓ |
| TOYOTA | Prius 1.5i 16V                       | (NHW11)          | 05/00 | 01/04 | ✓ |

**982 800**

|        |                 |                       |       |       |   |
|--------|-----------------|-----------------------|-------|-------|---|
| TOYOTA | Crown           | (MS122, LS120, YS120) | 08/83 | 08/87 | ✓ |
| TOYOTA | Crown           | (YS132, LS130, MS130) | 09/87 | 08/89 | ✓ |
| TOYOTA | Crown 2.0       | (YS130)               | 12/91 | 96    | ✓ |
| TOYOTA | Previa 2.4i 16V | (TCR1/2)              | 90    | 08/00 | ✓ |

**982 811**

|        |                          |          |    |       |   |
|--------|--------------------------|----------|----|-------|---|
| TOYOTA | Landcruiser 3.4 Diesel   | (BJ73)   | 90 | 04/95 | ✓ |
| TOYOTA | Landcruiser 3.5 Diesel   | (PZJ7..) | 90 | 04/95 | ✓ |
| TOYOTA | Landcruiser 4.2 Diesel   | (HZJ80)  | 90 | 94    | ✓ |
| TOYOTA | Landcruiser 4.2 Diesel   | (HZJ7..) | 90 | 04/95 | ✓ |
| TOYOTA | Landcruiser 4.2 Turbo D. | (HDJ80)  | 90 | 97    | ✓ |

**982 813**

|        |                          |            |       |       |   |
|--------|--------------------------|------------|-------|-------|---|
| TOYOTA | Landcruiser 2.4 Diesel   | (LJ70)     | 90    | 04/95 | ✓ |
| TOYOTA | Landcruiser 2.4 Turbo D. | (LJ70/73)  | 90    | 04/95 | ✓ |
| TOYOTA | Landcruiser 3.0 Turbo D. | (KZJ70)    | 90    | 04/95 | ✓ |
| TOYOTA | Landcruiser 3.0 Turbo D. | (KZJ90/95) | 04/96 | 03    | ✓ |
| TOYOTA | Landcruiser 3.4i 24V     | (VZJ90/95) | 04/96 | 03    | ✓ |

**982 816**

|        |                    |              |       |    |   |
|--------|--------------------|--------------|-------|----|---|
| TOYOTA | Starlet 1.0        | (EP70)       | 84    | 89 | ✓ |
| TOYOTA | Starlet 1.3        | (EP71)       | 10/84 | 89 | ✓ |
| TOYOTA | Starlet 1.5 Diesel | (NP70)       | 12/86 | 89 | ✓ |
| TOYOTA | Tercel 1.3         | (AL20, AL21) | 82    | 84 | ✓ |

**982 857**

|        |                    |             |       |       |   |
|--------|--------------------|-------------|-------|-------|---|
| TOYOTA | Corolla 1.4i 16V   | (EE101)     | 05/92 | 04/97 | ✓ |
| TOYOTA | Corolla 1.4i 16V   | (EE110/111) | 05/92 | 08/98 | ✓ |
| TOYOTA | Corolla 1.5i 16V   | (AE110)     | 05/95 | 98    | ✓ |
| TOYOTA | Corolla 1.6i 16V   | (AE100-111) | 05/92 | 08/98 | ✓ |
| TOYOTA | Corolla 2.0 Diesel | (CE100/110) | 05/92 | 07/00 | ✓ |

**982 884**

|        |                       |                |       |       |   |
|--------|-----------------------|----------------|-------|-------|---|
| TOYOTA | Hi-Ace 2.0i           | (YY101)        | 05/95 | 99    | ✓ |
| TOYOTA | Hi-Ace 2.2 D          | (LH50/60/70)   | 82    | 88    | ✓ |
| TOYOTA | Hi-Ace 2.4i 4WD       | (RZH109/119)   | 08/89 | 08/95 | ✓ |
| TOYOTA | Hi-Ace 2.4i           | (RZH133)       | 05/95 | 97    | ✓ |
| TOYOTA | Hi-Ace 2.4 D 4WD      | (LH108/118)    | 08/89 | 08/95 | ✓ |
| TOYOTA | Hi-Ace 2.8 D          | (LY101, LY111) | 05/95 | 99    | ✓ |
| TOYOTA | Hi-Ace 2.8 D 4WD      | (LY151, LY161) | 05/95 | 99    | ✓ |
| TOYOTA | Hi-Ace 3.0i           | (KZH132)       | 05/95 | 99    | ✓ |
| TOYOTA | Hi-Ace 3.0i 4WD       | (KZH138)       | 05/95 | 99    | ✓ |
| TOYOTA | Hi-Lux 4WD 2.2        | (YN110, YN106) | 08/88 | 05/94 | ✓ |
| TOYOTA | Hi-Lux 4WD 2.4        | (RN61)         | 08/88 | 95    | ✓ |
| TOYOTA | Hi-Lux 4WD 2.4        | (RN67)         | 08/94 | 98    | ✓ |
| TOYOTA | Hi-Lux 4WD 2.4        | (RN110, RN106) | 08/89 | 98    | ✓ |
| TOYOTA | Hi-Lux 4WD 2.4i 16V   | (RZN168, 173)  | 08/97 | 02    | ✓ |
| TOYOTA | Hi-Lux 4WD 2.4 D      | (LN105)        | 08/88 | 98    | ✓ |
| TOYOTA | Hi-Lux 4WD 2.4 D      | (LN108)        | 08/91 | 98    | ✓ |
| TOYOTA | Hi-Lux 4WD 2.4 D      | (LN110)        | 08/93 | 98    | ✓ |
| TOYOTA | Hi-Lux 4WD 2.4 TD     | (LN165, LN170) | 08/97 | 03    | ✓ |
| TOYOTA | Hi-Lux 4WD 2.8 D      | (LN67)         | 08/95 | 98    | ✓ |
| TOYOTA | Hi-Lux 4-Runner 2.4TD | (LN130)        | 01/90 | 98    | ✓ |

**982 884**

|        |                                       |               |       |       |   |
|--------|---------------------------------------|---------------|-------|-------|---|
| TOYOTA | Hi-Lux 4-Runner 2.7i16V(RZN85W, 180)  |               | 11/95 | 03    | ✓ |
| TOYOTA | Hi-Lux 4-Runner 3.0i12V               | (VZN130)      | 08/89 | 99    | ✓ |
| TOYOTA | Hi-Lux 4-Runner 3.0TD                 | (KZN130)      | 08/93 | 99    | ✓ |
| TOYOTA | Hi-Lux 4-Runner 3.0D                  | (KZN85G, 85W) | 11/95 | 03    | ✓ |
| TOYOTA | Hi-Lux 4-Runner 3.4iV624V(VZN85, 180) |               | 11/95 | 03    | ✓ |
| TOYOTA | Kijang                                | (LF30, RF30)  | 01/81 | 09/85 | ✓ |

**982 939**

|        |                                    |            |       |       |   |
|--------|------------------------------------|------------|-------|-------|---|
| TOYOTA | Yaris 1.0i 16V                     | (CP10)     | 99    | 05    | ✓ |
| TOYOTA | Yaris 1.0i VVT-i, 1.3i VVT-i, D-4D |            | 01/06 | 06    | ✓ |
| TOYOTA | Yaris 1.3i 16V                     | (CP10/11)  | 99    | 12/05 | ✓ |
| TOYOTA | Yaris 1.4 D-4D, 1.5 VVT-i          | (CP10/11)  | 01    | 05    | ✓ |
| TOYOTA | Yaris 1.5 TS                       | (CP10/11)  | 03    | 05    | ✓ |
| TOYOTA | Yaris Verso 1.3i 16V               | (NCP20)    | 99    | 05    | ✓ |
| TOYOTA | Yaris Verso 1.4 D-4D               | (NLP20/22) | 01    | 05    | ✓ |
| TOYOTA | Yaris Verso 1.5 VVT-i              | (NCP21)    | 00    | 05    | ✓ |

**982 945**

|        |                     |          |    |       |   |
|--------|---------------------|----------|----|-------|---|
| TOYOTA | Previa 2.4i 16V 4WD | (TCR1/2) | 90 | 08/00 | ✓ |
|--------|---------------------|----------|----|-------|---|

**982 948**

|        |                                      |  |       |    |   |
|--------|--------------------------------------|--|-------|----|---|
| TOYOTA | Avensis, Avensis Station Wagon (T22) |  | 10/97 | 04 | ✓ |
|--------|--------------------------------------|--|-------|----|---|

**991 749**

|          |                                   |  |       |    |   |
|----------|-----------------------------------|--|-------|----|---|
| CHRYSLER | PT Cruiser 1.6, 2.0, 2.2 CRD, 2.4 |  | 03/02 | 05 | ✓ |
|----------|-----------------------------------|--|-------|----|---|

**991 788**

|          |                          |  |    |       |   |
|----------|--------------------------|--|----|-------|---|
| CHRYSLER | PT Cruiser 1.6, 2.0, 2.4 |  | 00 | 02/02 | ✓ |
|----------|--------------------------|--|----|-------|---|

**991 861**

|          |                            |      |       |    |   |
|----------|----------------------------|------|-------|----|---|
| CHRYSLER | Jeep Cherokee 2.1 TD, 2.5i | (XJ) | 09/99 | 05 | ✓ |
| CHRYSLER | Jeep Cherokee 2.5 TD, 4.0i | (XJ) | 09/99 | 05 | ✓ |
| CHRYSLER | Jeep Wrangler II           | (TJ) | 09/96 | 05 | ✓ |

**991 863**

|          |                                    |  |       |    |   |
|----------|------------------------------------|--|-------|----|---|
| CHRYSLER | Jeep Grand Cherokee II 2.7 CRD     |  | 01    | 05 | ✓ |
| CHRYSLER | Jeep Grand Cherokee II 3.1 TD, 4.0 |  | 04/99 | 05 | ✓ |
| CHRYSLER | Jeep Grand Cherokee II 4.7 V8      |  | 04/99 | 05 | ✓ |

**991 898**

|          |            |      |       |       |   |
|----------|------------|------|-------|-------|---|
| CHRYSLER | Voyager I  | (ES) | 90    | 01/95 | ✓ |
| CHRYSLER | Voyager II | (GS) | 01/95 | 03/01 | ✓ |
| DODGE    | Caravan    |      | 89    | 95    | ✓ |

**991 902**

|            |                   |                 |       |       |   |
|------------|-------------------|-----------------|-------|-------|---|
| MITSUBISHI | Galant 1.8, 2.0   | (E52, E54, E55) | 01/92 | 04/95 | ✓ |
| MITSUBISHI | Galant 2.0        | (E64)           | 01/92 | 11/94 | ✓ |
| MITSUBISHI | Galant 2.0        | (EA7A)          | 05/00 | 03    | ✓ |
| MITSUBISHI | Galant 2.0 Diesel | (E57)           | 01/92 | 04/95 | ✓ |
| MITSUBISHI | Galant 2.4        | (E56A)          | 93    | 05/94 | ✓ |
| MITSUBISHI | Galant 2.4        | (EA3A)          | 06/96 | 03    | ✓ |
| MITSUBISHI | Galant 2.5        | (E98A)          | 06/94 | 08/94 | ✓ |
| MITSUBISHI | Galant 2.5        | (EC5A)          | 05/00 | 03    | ✓ |
| PROTON     | Perdana 2.0i      | (E55A)          | 94    | 95    | ✓ |

**991 946**

|          |                                |         |    |       |   |
|----------|--------------------------------|---------|----|-------|---|
| CHRYSLER | Jeep Cherokee 2.1 TD, 2.5i     | (XJ)    | 91 | 08/99 | ✓ |
| CHRYSLER | Jeep Cherokee 2.5 TD, 4.0i     | (XJ)    | 91 | 08/99 | ✓ |
| CHRYSLER | Jeep Grand Cherokee 4.0i, 5.2i | (Z, ZJ) | 91 | 08/99 | ✓ |
| CHRYSLER | Jeep Wrangler                  |         | 91 | 08/96 | ✓ |

**991 998**

|          |            |      |       |       |   |
|----------|------------|------|-------|-------|---|
| CHRYSLER | Voyager I  | (ES) | 90    | 01/95 | ✓ |
| CHRYSLER | Voyager II | (GS) | 01/95 | 03/01 | ✓ |

**992 663**

|          |                          |  |       |    |   |
|----------|--------------------------|--|-------|----|---|
| CHRYSLER | Neon II                  |  | 99    | 02 | ✓ |
| CHRYSLER | PT Cruiser 1.6, 2.0, 2.4 |  | 00    | 05 | ✓ |
| CHRYSLER | PT Cruiser 2.2 CRD       |  | 03/02 | 05 | ✓ |

**992 689**

|          |                                   |  |       |    |  |   |
|----------|-----------------------------------|--|-------|----|--|---|
| CHRYSLER | Neon II                           |  | 99    | 02 |  | ✓ |
| CHRYSLER | PT Cruiser 1.6, 2.0, 2.2 CRD, 2.4 |  | 03/02 | 05 |  | ✓ |

**992 754**

|          |                          |  |    |       |  |   |
|----------|--------------------------|--|----|-------|--|---|
| CHRYSLER | PT Cruiser 1.6, 2.0, 2.4 |  | 00 | 02/02 |  | ✓ |
|----------|--------------------------|--|----|-------|--|---|

**992 894**

|            |                   |            |       |       |  |   |
|------------|-------------------|------------|-------|-------|--|---|
| MITSUBISHI | Galant 1.8        | (E52)      | 01/92 | 04/95 |  | ✓ |
| MITSUBISHI | Galant 2.0        | (E54, E55) | 01/92 | 04/95 |  | ✓ |
| MITSUBISHI | Galant 2.0        | (E64)      | 01/92 | 11/94 |  | ✓ |
| MITSUBISHI | Galant 2.0        | (EA7A)     | 05/00 | 03    |  | ✓ |
| MITSUBISHI | Galant 2.0 Diesel | (E57)      | 01/92 | 04/95 |  | ✓ |
| MITSUBISHI | Galant 2.4        | (E56A)     | 93    | 05/94 |  | ✓ |
| MITSUBISHI | Galant 2.4        | (EA3A)     | 06/96 | 03    |  | ✓ |
| MITSUBISHI | Galant 2.5        | (E98A)     | 06/94 | 08/94 |  | ✓ |
| MITSUBISHI | Galant 2.5        | (EC5A)     | 05/00 | 03    |  | ✓ |
| PROTON     | Perdana 2.0i      | (E55A)     | 94    | 95    |  | ✓ |

**992 922**

|          |             |      |       |       |  |   |
|----------|-------------|------|-------|-------|--|---|
| CHRYSLER | Voyager II  | (GS) | 01/95 | 03/01 |  | ✓ |
| CHRYSLER | Voyager III | (RG) | 02/00 | 04    |  | ✓ |

**992 943**



|          |           |      |    |       |  |   |
|----------|-----------|------|----|-------|--|---|
| CHRYSLER | Voyager I | (ES) | 90 | 01/95 |  | ✓ |
|----------|-----------|------|----|-------|--|---|







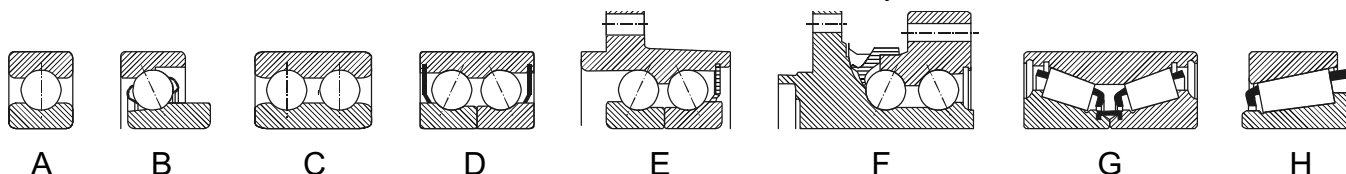



**SATZ-INHALT**  
**CONTENT OF KITS**  
**CONTENU DES KITS**



| OPTIMAL   |   |   |   |   |   |   |   |  |   |   |
|-----------|---|---|---|---|---|---|---|--|---|---|
| 100 002   | H | 2 | 1 | 1 |   |   | 1 |  | 1 |   |
| 100 002 L | H | 2 | 1 | 1 |   |   | 1 |  | 1 | 1 |
| 100 002 S | H | 2 | 1 |   |   |   | 1 |  |   |   |
| 100 003   | D | 1 |   | 1 |   | 1 |   |  |   |   |
| 100 007   | E | 1 |   |   | 5 |   |   |  |   |   |
| 100 013   | E | 1 |   | 1 |   |   |   |  |   |   |
| 100 014   | D | 1 |   | 4 | 3 | 2 | 1 |  |   |   |
| 100 014 S | D | 1 |   | 1 |   | 2 |   |  |   |   |
| 100 022   | D | 1 |   | 4 | 1 | 2 |   |  |   |   |
| 100 022 S | D | 1 |   | 1 |   | 2 |   |  |   |   |
| 100 036   | D | 1 |   | 3 | 1 | 2 |   |  |   |   |
| 100 036 S | D | 1 |   | 1 |   | 2 |   |  |   |   |
| 100 053   | E | 1 |   |   | 5 |   |   |  |   |   |
| 100 056   | D | 1 |   | 1 |   | 1 |   |  |   |   |
| 100 090   | D | 1 |   | 3 | 2 |   |   |  |   |   |
| 100 091   | D | 1 |   | 4 | 1 |   |   |  |   |   |
| 100 093   | D | 1 |   |   | 1 |   |   |  |   |   |
| 100 098   | D | 1 |   |   | 1 | 2 |   |  |   |   |
| 100 099   | D | 1 |   | 3 | 2 |   |   |  |   |   |
| 100 206   | D | 1 |   | 1 |   | 1 |   |  |   |   |
| 101 005   | D | 1 |   | 1 |   | 1 |   |  |   |   |
| 101 010   | D | 1 |   | 4 | 2 | 2 |   |  |   |   |
| 101 016   | D | 1 |   | 4 | 1 | 2 |   |  |   |   |
| 101 016 S | D | 1 |   | 1 |   | 2 |   |  |   |   |
| 101 017   | F | 1 |   |   | 5 |   |   |  |   |   |
| 101 024   | D | 1 |   | 3 | 1 | 2 |   |  |   |   |
| 101 025   | E | 1 |   | 1 |   |   |   |  |   |   |
| 101 027   | E | 1 |   | 1 |   |   |   |  |   |   |
| 101 029   | E | 1 |   | 1 |   |   |   |  |   |   |
| 101 044   | D | 1 |   | 4 | 3 | 2 |   |  |   |   |
| 101 044 S | D | 1 |   | 1 |   | 2 |   |  |   |   |
| 101 064   | H | 2 | 1 | 1 |   |   |   |  |   |   |
| 101 102   | H | 2 | 1 | 1 |   |   |   |  |   |   |
| 101 105   | D | 1 | 2 | 1 |   | 1 |   |  |   |   |
| 101 108   | H | 2 | 1 | 1 |   |   |   |  |   |   |
| 101 110   | H | 2 | 1 | 1 |   |   |   |  |   |   |
| 101 111   | D | 1 |   | 1 |   |   |   |  |   |   |
| 101 113   | D | 1 |   | 1 |   | 1 |   |  |   |   |
| 101 128   | D | 1 |   | 2 | 4 | 1 |   |  |   |   |
| 101 145   | H | 2 | 1 |   |   |   |   |  |   |   |
| 101 209   | D | 1 |   | 2 | 6 | 1 |   |  |   |   |
| 101 250   | H | 2 | 1 |   |   |   |   |  |   |   |
| 101 264   | H | 2 | 1 |   |   |   |   |  |   |   |
| 101 270   | H | 2 | 1 |   |   |   |   |  |   |   |
| 102 008   | H | 2 | 1 |   |   |   | 1 |  |   |   |

L = lange Version      D = lange Version      En = long version      F = version longue      Pl = rozszerzona wersja      Cz = dlouhá verze      Es = versión larga  
S = kurze Version      S = kurze Version      S = short version      S = version courte      S = krótka wersja      S = krátká verze      S = versión corta



| OPTIMAL   |  |  |  |  |  |  |  |  |  |  |  |
|-----------|---|---|---|---|---|---|---|---|---|---|---|
| 102 008 L | H   | 2   | 1   | 1   |   | 1   |   |   | 1   |   | 1   |
| 102 009   | H   | 2   | 1   |   |   | 1   |   |   | 1   |   |   |
| 102 011   | F   | 1   |   |   |   |   |   |   |   |   |   |
| 102 015   | E   | 1   |   | 1   |   |   |   |   |   |   |   |
| 102 019   | F   | 1   |   | 1   |   |   |   |   |   |   |   |
| 102 041   | D   | 1   |   | 1   |   |   |   |   |   |   |   |
| 102 054   | H   | 1   | 1   |   |   |   |   | 1   |   | 2   |   |
| 102 055   | H   | 2   | 1   |   |   | 1   |   |   | 1   |   |   |
| 102 060   | H   | 2   | 1   | 1   |   |   |   |   |   | 1   |   |
| 102 069   | E   | 1   |   | 1   |   |   |   |   |   |   |   |
| 102 071   | E   | 1   |   | 1   |   |   |   |   |   |   | 1   |
| 102 075   | E   | 1   |   | 1   |   |   |   |   |   |   |   |
| 102 077   | E   | 1   |   | 1   |   |   |   |   |   |   |   |
| 102 079   | E   | 1   |   | 1   |   |   |   |   |   |   |   |
| 102 094   | A+H   | 2   | 2   |   |   | 1   | 1   |   |   |   |   |
| 102 097   | E   | 1   |   | 1   |   |   |   |   |   |   |   |
| 102 103   | D   | 1   |   |   |   |   |   |   |   |   |   |
| 102 115   | E   | 1   |   | 1   |   |   |   |   |   |   |   |
| 102 150   | H   | 2   | 1   | 1   |   |   |   |   |   |   |   |
| 102 152   | H   | 1   | 1   |   |   |   |   | 1   |   | 2   |   |
| 102 154   | H   | 1   | 1   |   |   |   |   | 1   |   | 2   |   |
| 102 156   | H   | 1   | 1   |   |   | 1   |   | 1   |   | 2   |   |
| 102 158   | E   | 1   |   | 1   |   |   |   |   |   |   |   |
| 102 207   | G   | 1   |   | 1   | 1   | 1   |   |   |   |   |   |
| 102 213   | E   | 1   |   |   |   |   |   |   |   |   | 1   |
| 102 266   | A+H   | 2   | 2   |   |   | 1   | 1   |   |   | 1   |   |
| 102 268   | D   | 1   |   |   |   | 1   |   |   |   |   |   |
| 131 129   | D   | 1   |   | 1   | 1   |   |   |   |   |   |   |
| 132 131   | D   | 1   |   | 1   | 1   | 1   |   |   |   |   |   |
| 190 256   | H   | 2   | 2   |   |   | 1   |   |   | 1   |   |   |
| 191 258   | H   | 2   | 1   |   |   | 1   |   |   |   |   |   |
| 191 272   | H   | 2   | 1   |   |   |   | 1   |   |   |   |   |
| 192 274   | A   | 1   | 2   |   |   | 1   |   | 1   |   | 1   |   |
| 200 012   | H   | 2   | 1   |   |   |   | 1   |   |   |   |   |
| 200 020   | H   | 2   | 1   |   |   |   | 1   |   |   |   |   |
| 201 031   | F   | 1   |   |   |   |   | 1   |   |   |   |   |
| 201 032   | D   | 1   |   |   |   | 2   | 1   |   |   |   |   |
| 201 033   | F   | 1   |   |   |   |   | 1   |   |   |   |   |
| 201 035   | F   | 1   |   |   |   |   | 1   |   |   |   |   |
| 201 040   | D   | 1   |   |   |   | 2   | 1   |   |   |   |   |
| 201 043   | F   | 1   |   |   | 3   |   | 1   |   |   |   | 1   |
| 201 084   | E   | 1   |   | 1   |   |   |   |   |   |   |   |
| 201 085   | D   | 1   |   | 1   |   |   |   |   |   |   |   |
| 201 087   | D   | 1   |   | 1   |   | 1   |   |   |   |   |   |
| 201 089   | D   | 1   |   | 1   |   |   |   |   |   |   | 1   |

L = lange Version  
 S = kurze Version  
 D = lange Version  
 En = long version  
 F = version longue  
 PI = rozszerzona wersja  
 Cz = dlouhá verze  
 Es = versió larga  
 S = kurze Version  
 En = short version  
 F = version courte  
 PI = krótká wersja  
 Cz = krátká verze  
 Es = versió corta

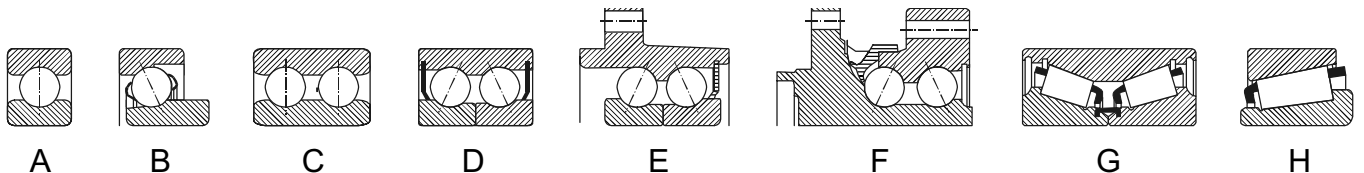









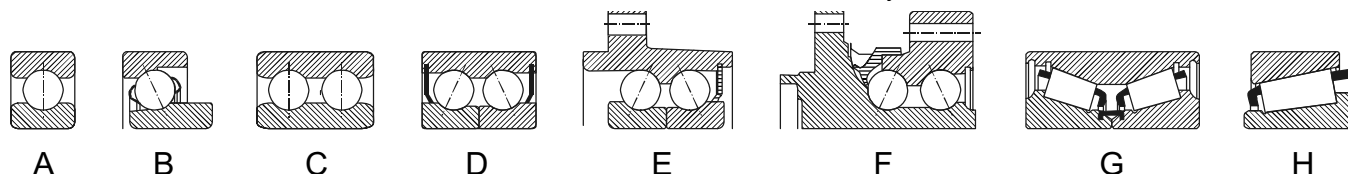



**SATZ-INHALT**  
**CONTENT OF KITS**  
**CONTENU DES KITS**



| OPTIMAL |   |   |   |   |   |   |  |   |   |   |
|---------|---|---|---|---|---|---|--|---|---|---|
| 201 095 | D | 1 |   |   | 2 | 1 |  |   |   |   |
| 201 210 | D | 1 |   |   | 2 | 1 |  |   |   |   |
| 201 228 | D | 1 |   |   | 2 | 1 |  |   |   |   |
| 201 262 | H | 2 | 1 |   |   |   |  |   |   |   |
| 201 517 | F | 1 |   | 1 | 3 |   |  |   |   | 1 |
| 201 621 | F | 1 |   |   |   |   |  |   |   |   |
| 201 623 | F | 1 |   |   |   |   |  |   |   |   |
| 201 671 | F | 1 |   |   |   |   |  |   |   |   |
| 202 021 | G | 1 |   | 1 | 1 |   |  |   |   | 1 |
| 202 023 | E | 1 |   | 1 |   |   |  |   |   | 1 |
| 202 026 | D | 1 |   |   | 1 |   |  |   |   |   |
| 202 059 | F | 1 |   | 4 |   |   |  |   |   |   |
| 202 065 | H | 2 | 1 |   |   | 1 |  |   |   |   |
| 202 101 | G | 1 |   | 1 | 1 |   |  |   |   | 1 |
| 202 140 | F | 1 |   | 4 |   |   |  |   |   |   |
| 202 142 | F | 1 |   | 4 |   |   |  |   |   |   |
| 202 153 | A | 1 |   |   |   |   |  | 1 |   | 1 |
| 202 155 | A | 1 |   |   |   |   |  | 1 |   | 1 |
| 202 168 | D | 1 |   |   | 1 |   |  |   |   |   |
| 202 202 | A | 1 |   |   |   |   |  | 1 |   | 1 |
| 202 204 | A | 1 |   |   |   |   |  | 1 |   | 1 |
| 202 205 | H | 1 | 1 | 1 |   |   |  |   |   |   |
| 202 218 | F | 1 |   | 4 |   |   |  |   |   |   |
| 202 224 | D | 1 |   |   | 1 |   |  |   |   |   |
| 202 226 | D | 1 |   |   | 1 |   |  |   |   |   |
| 202 236 | A | 1 |   |   |   |   |  | 1 |   | 1 |
| 202 519 | F | 1 |   | 4 |   |   |  |   |   |   |
| 202 625 | F | 1 |   |   |   |   |  |   |   |   |
| 202 627 | F | 1 |   |   |   |   |  |   |   |   |
| 202 673 | F | 1 |   |   |   |   |  |   |   |   |
| 300 004 | H | 2 | 1 |   |   | 1 |  |   | 1 |   |
| 300 052 | H | 2 | 1 |   |   | 1 |  |   |   |   |
| 300 062 | H | 2 | 1 |   |   | 1 |  |   |   |   |
| 301 006 | H | 2 | 2 | 1 |   |   |  |   |   |   |
| 301 018 | H | 2 | 2 | 1 |   |   |  |   |   |   |
| 301 034 | H | 2 | 1 | 1 |   |   |  |   |   |   |
| 301 038 | H | 2 | 1 | 1 |   |   |  |   |   |   |
| 301 039 | D | 1 |   | 1 | 1 |   |  |   |   |   |
| 301 045 | D | 1 |   | 1 | 1 |   |  |   |   |   |
| 301 118 | H | 2 | 1 |   |   | 1 |  |   |   |   |
| 301 130 | H | 2 | 2 | 1 |   |   |  |   |   |   |
| 301 132 | D | 1 |   | 1 | 1 |   |  |   |   |   |
| 301 139 | D | 1 |   | 1 | 2 |   |  |   |   |   |
| 301 141 | D | 1 |   | 1 | 2 |   |  |   |   |   |
| 301 151 | H | 2 | 1 |   |   | 1 |  |   |   |   |

L = lange Version      D = lange Version      En = long version      F = version longue      Pl = rozszerzona wersja      Cz = dlouhá verze      Es = versión larga  
S = kurze Version      S = kurze Version      S = short version      S = version courte      S = krótka wersja      S = krátká verze      S = versión corta



| OPTIMAL   |  |  |  |  |  |  |  |  |  |  |  |
|-----------|---|---|---|---|---|---|---|---|---|---|---|
| 301 180   | H   | 2   |   | 1   |   |   |   |   |   |   |   |
| 301 182   | D   | 1   |   | 1   |   | 2   |   |   |   |   |   |
| 301 183   | D   | 1   |   | 1   |   | 2   |   |   |   |   |   |
| 301 185   | G   | 1   |   | 1   | 5   |   | 1   |   | 1   |   |   |
| 301 198   | D   | 1   |   | 1   |   | 2   |   |   |   |   |   |
| 301 200   | D   | 1   |   | 1   |   | 2   |   |   |   |   |   |
| 301 230   | H   | 2   | 2   | 1   |   |   |   |   |   |   |   |
| 301 232   | H   | 2   | 2   | 1   |   |   |   |   |   |   |   |
| 301 244   | H   | 2   | 1   | 1   |   |   |   |   |   |   |   |
| 301 246   | H   | 2   | 1   | 1   |   |   |   |   |   |   |   |
| 301 280   | H   | 2   | 1   |   |   | 1   |   |   |   |   |   |
| 301 511   | D   | 1   |   | 1   |   | 1   |   |   |   |   |   |
| 301 667   | E   | 1   |   | 1   |   |   |   |   |   |   |   |
| 302 037   | F   | 1   |   |   |   |   |   |   |   |   |   |
| 302 046   | H   | 2   | 2   | 1   |   |   |   |   |   |   |   |
| 302 057   | G   | 1   |   | 1   |   | 1   |   |   |   |   |   |
| 302 058   | H   | 2   | 1   |   |   |   |   |   |   |   |   |
| 302 058 L | G   | 2   | 1   | 2   |   |   |   |   |   |   |   |
| 302 067   | H   | 2   | 2   | 1   |   |   |   |   |   |   |   |
| 302 074   | H   | 2   | 2   | 1   |   |   |   |   |   |   |   |
| 302 076   | H   | 2   | 2   | 1   |   |   |   |   |   |   |   |
| 302 120   | H   | 2   | 2   | 1   |   |   |   |   |   |   |   |
| 302 122   | H   | 2   | 2   | 1   |   |   |   |   |   |   |   |
| 302 124   | H   | 2   | 2   |   |   |   |   |   |   |   |   |
| 302 146   | A   | 1   |   |   |   |   |   | 1   |   |   |   |
| 302 160   | A   | 1   | 1   | 1   |   |   |   |   |   | 1   |   |
| 302 162   | H   | 2   | 1   |   |   |   |   | 1   |   |   |   |
| 302 164   | D   | 1   | 1   |   |   |   |   |   |   | 1   |   |
| 302 166   | G   | 1   | 1   |   |   |   |   |   |   |   |   |
| 302 172   | C   | 1   | 1   |   |   |   |   |   |   | 2   |   |
| 302 174   | C   | 1   | 1   | 1   |   |   |   |   |   | 2   |   |
| 302 176   | C   | 1   | 1   | 1   |   |   |   |   |   | 2   |   |
| 302 186   | E   | 1   |   | 1   |   |   |   |   |   |   |   |
| 302 188   | E   | 1   |   | 1   |   |   |   |   |   |   |   |
| 302 190   | F   | 1   |   | 1   |   |   |   |   |   |   |   |
| 302 192   | F   | 1   |   |   |   |   |   |   |   |   |   |
| 302 196   | E   | 1   |   | 1   |   |   |   |   |   |   |   |
| 302 197   | F   | 1   |   |   |   |   |   |   |   |   |   |
| 302 208   | H   | 1   | 1   |   |   |   |   |   |   |   |   |
| 302 234   | D   | 1   | 2   |   |   |   |   |   |   |   |   |
| 302 240   | C   | 1   | 1   |   |   |   |   |   |   | 1   |   |
| 302 248   | H   | 2   | 1   |   |   |   |   |   |   |   |   |
| 302 254   | A   | 1   |   |   |   |   |   | 1   |   |   |   |
| 302 255   | E   | 1   |   | 1   |   |   |   |   |   |   |   |
| 302 257   | E   | 1   |   | 1   |   |   |   |   |   |   |   |

L = lange Version      D = lange Version      En = long version      F = version longue      Pl = rozszerzona wersja      Cz = dlouhá verze      Es = versión larga  
 S = kurze Version      S = kurze Version      S = short version      S = version courte      S = krótká wersja      S = krátká verze      S = versión corta

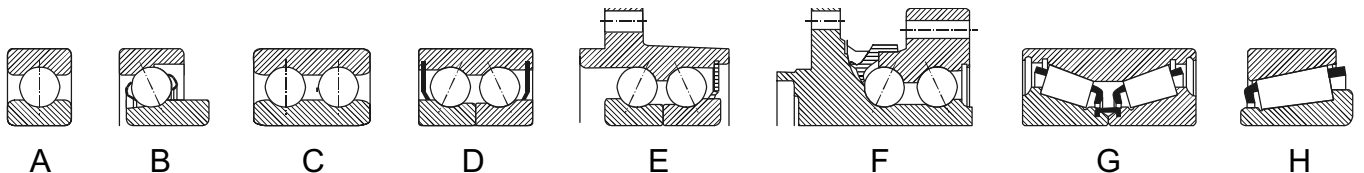

**SATZ-INHALT**  
**CONTENT OF KITS**  
**CONTENU DES KITS**







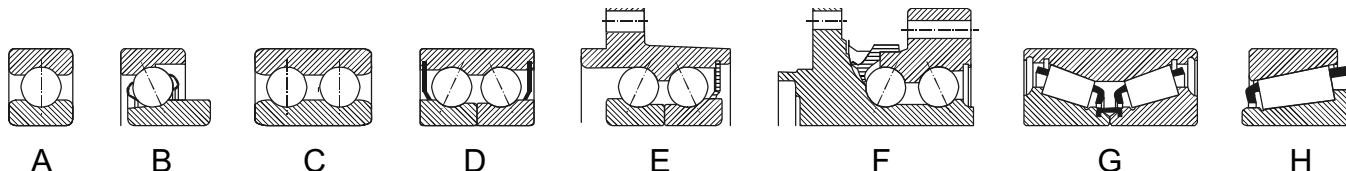





| OPTIMAL   |   |   |   |   |   |   |   |   |   |   |
|-----------|---|---|---|---|---|---|---|---|---|---|
| 302 260   | H | 2 | 1 |   |   |   |   |   |   |   |
| 400 051   | D | 1 |   | 1 |   | 1 |   |   |   |   |
| 400 061   | D | 1 |   | 1 |   | 1 |   |   |   |   |
| 400 061 L | D | 1 |   | 1 | 3 | 1 |   |   |   |   |
| 400 107   | D | 1 |   | 1 |   | 1 |   |   |   |   |
| 401 028   | H | 2 | 1 |   |   |   |   |   |   |   |
| 401 028 L | H | 2 | 1 |   | 1 |   |   | 2 |   | 1 |
| 401 042   | H | 2 | 1 |   |   |   |   |   |   |   |
| 401 042 L | H | 2 | 1 |   | 3 |   |   | 1 |   | 1 |
| 401 047   | D | 1 |   | 1 |   | 1 |   |   |   |   |
| 401 047 L | D | 1 |   | 1 |   | 1 |   |   |   | 1 |
| 401 048   | H | 2 | 1 |   |   |   |   |   |   |   |
| 401 048 L | H | 2 | 1 |   | 3 |   |   | 1 |   | 1 |
| 401 078   | H | 2 | 1 |   |   |   |   |   |   |   |
| 401 078 L | H | 2 | 1 |   | 3 |   |   |   |   | 1 |
| 401 082   | H | 2 | 1 |   |   |   |   |   |   |   |
| 401 082 L | H | 2 | 1 |   | 4 |   |   | 1 |   | 1 |
| 401 083   | H | 2 | 1 |   |   |   |   |   |   |   |
| 401 096   | D | 1 |   | 1 |   | 1 |   |   |   |   |
| 401 100   | H | 2 | 2 |   |   |   |   |   |   |   |
| 401 104   | H | 2 | 3 |   |   |   |   |   |   |   |
| 401 126   | H | 2 | 1 |   |   |   |   |   |   |   |
| 401 126 L | H | 2 | 1 |   | 1 |   |   | 1 |   | 1 |
| 401 137   | H | 2 | 1 |   |   |   |   | 2 |   |   |
| 401 157   | H | 2 | 1 |   | 1 |   |   |   |   | 1 |
| 401 212   | H | 2 | 2 |   |   |   |   | 1 |   |   |
| 401 214   | H | 2 | 2 | 1 |   |   | 1 |   |   |   |
| 401 222   | H | 2 | 1 |   |   |   |   |   |   |   |
| 401 276   | H | 2 | 1 |   |   |   |   |   |   |   |
| 401 277   | H | 2 | 1 |   |   |   |   |   |   |   |
| 401 277 L | H | 2 | 1 |   | 3 |   |   | 1 |   | 1 |
| 401 300   | E | 1 |   |   |   |   |   |   |   |   |
| 401 501   | G | 2 | 1 |   |   |   |   |   |   | 1 |
| 402 030   | H | 2 | 2 | 1 |   |   | 1 |   |   |   |
| 402 030 L | H | 2 | 2 | 1 |   |   | 1 | 1 | 1 |   |
| 402 050   | H | 1 | 3 | 6 |   |   | 1 |   | 1 | 2 |
| 402 050 S | H | 1 | 2 |   |   |   |   |   |   |   |
| 402 063   | G | 1 |   | 1 |   | 1 |   |   |   |   |
| 402 063 L | G | 1 |   | 1 |   | 1 |   |   |   | 1 |
| 402 073   | G | 1 |   | 1 |   | 1 |   |   |   |   |
| 402 080   | G | 1 |   | 1 |   | 1 |   |   |   |   |
| 402 080 L | G | 1 |   | 1 | 9 | 1 |   |   | 2 |   |
| 402 081   | D | 1 |   | 1 |   | 1 |   |   |   |   |
| 402 116   | D | 1 |   | 1 |   | 1 |   |   |   |   |
| 402 116 L | D | 1 |   | 1 | 9 | 1 |   |   | 2 |   |

L = lange Version      D = lange Version      En = long version      F = version longue      Pl = rozszerzona wersja      Cz = dlouhá verze      Es = versión larga  
S = kurze Version      S = kurze Version      S = short version      S = version courte      S = krótka wersja      S = krátká verze      S = versión corta





| OPTIMAL   |  |  |  |  |  |  |  |  |  |  |  |
|-----------|---|---|---|---|---|---|---|---|---|---|---|
| 402 117   | G   | 1   | 2   |   |   |   |   |   |   |   |   |
| 402 119   | H   | 2   | 1   |   |   |   |   |   |   |   |   |
| 402 143   | H   | 2   | 1   |   |   |   |   |   |   |   |   |
| 402 159   | D   | 1   |   | 1   | 9   |   |   |   | 2   |   |   |
| 402 216   | H   | 2   | 1   |   |   |   |   |   |   |   |   |
| 402 242   | D   | 1   |   | 1   |   | 1   |   |   |   |   |   |
| 402 242 L | D   | 1   |   | 1   | 8   | 1   |   |   | 2   |   |   |
| 402 243   | D   | 1   |   | 1   |   | 1   |   |   |   |   |   |
| 402 243 L | D   | 1   |   | 1   | 8   | 1   |   |   | 2   |   |   |
| 402 301   | F   | 1   |   |   |   |   |   |   |   |   |   |
| 402 505   | E   | 1   |   | 1   | 4   |   |   |   |   |   |   |
| 501 049   | E   | 1   |   | 1   |   |   |   |   |   |   |   |
| 501 088   | E   | 1   |   | 1   |   |   |   |   |   |   |   |
| 501 092   | H   | 2   | 1   |   |   | 1   |   |   |   |   |   |
| 501 112   | E   | 1   |   | 1   |   |   |   |   |   |   |   |
| 501 114   | E   | 1   |   | 1   |   |   |   |   |   |   |   |
| 501 121   | F   | 1   |   |   | 4   |   |   |   |   |   |   |
| 501 133   | E   | 1   |   | 1   |   |   |   |   |   |   |   |
| 501 136   | E   | 1   |   | 1   |   |   |   |   |   |   |   |
| 501 147   | F   | 1   |   |   |   |   |   |   |   |   |   |
| 501 158   | D   | 1   |   | 1   |   | 1   |   |   |   |   |   |
| 501 161   | F   | 1   |   | 1   |   |   |   |   |   |   |   |
| 501 170   | E   | 1   |   | 1   |   |   |   |   |   |   |   |
| 501 184   | H   | 2   | 1   |   |   |   | 1   |   |   |   |   |
| 501 194   | H   | 2   | 1   |   |   |   | 1   |   |   |   |   |
| 501 513   | F   | 1   |   |   | 4   |   |   |   |   |   |   |
| 501 653   | E   | 1   |   | 1   |   |   |   |   |   |   |   |
| 502 066   | D   | 1   |   |   |   | 1   |   |   | 1   |   |   |
| 502 068   | D   | 1   |   |   |   | 1   |   |   | 1   |   |   |
| 502 070   | D   | 1   |   |   |   | 1   |   |   | 1   |   |   |
| 502 072   | D   | 1   |   |   |   | 1   |   |   | 1   |   |   |
| 502 109   | D   | 1   |   | 1   |   | 1   |   |   |   |   |   |
| 502 123   | E   | 1   |   | 1   |   |   |   |   |   |   |   |
| 502 125   | D   | 1   |   | 1   |   | 1   |   |   | 1   |   |   |
| 502 134   | A   | 2   | 2   |   |   |   | 1   |   |   |   |   |
| 502 135   | D   | 1   |   | 1   |   | 1   |   |   |   |   |   |
| 502 138   | D   | 1   |   | 1   |   | 1   |   |   |   |   |   |
| 502 148   | D   | 1   |   | 1   |   | 1   |   |   |   |   |   |
| 502 163   | F   | 1   |   |   |   |   |   |   |   |   |   |
| 502 178   | A   | 2   | 2   |   |   |   |   |   | 2   |   |   |
| 502 252   | E   | 1   |   | 1   | 4   |   |   |   |   |   |   |
| 600 308   | D   | 1   |   | 1   |   | 1   |   |   |   |   |   |
| 600 334   | D   | 1   |   | 1   |   | 1   |   |   |   |   |   |
| 600 410   | H   | 2   | 1   | 1   |   |   |   |   |   |   |   |
| 601 253   | D   | 1   |   | 1   |   | 1   |   |   |   |   |   |

L = lange Version      D = lange Version      En = long version      F = version longue      Pl = rozszerzona wersja      Cz = dlouhá verze      Es = versión larga  
 S = kurze Version      S = kurze Version      S = short version      S = version courte      S = krótka wersja      S = krátká verze      S = versión corta

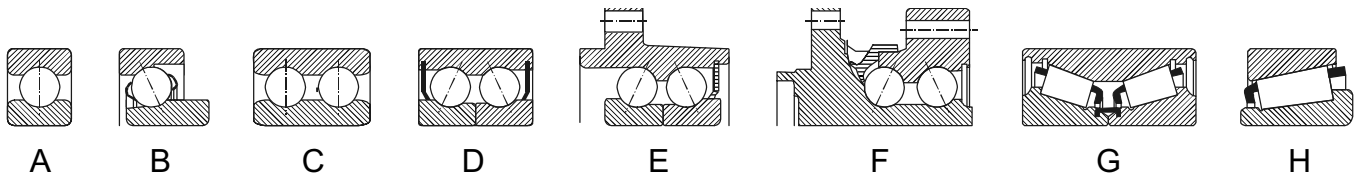

**SATZ-INHALT**  
**CONTENT OF KITS**  
**CONTENU DES KITS**



| OPTIMAL |   |   |   |   |  |   |   |  |  |   |  |
|---------|---|---|---|---|--|---|---|--|--|---|--|
| 601 306 | D | 1 |   | 1 |  | 1 |   |  |  |   |  |
| 601 323 | D | 1 |   |   |  | 1 | 1 |  |  |   |  |
| 601 336 | D | 1 |   |   |  | 1 |   |  |  |   |  |
| 601 348 | D | 1 |   |   |  | 1 |   |  |  |   |  |
| 601 384 | H | 2 | 1 | 1 |  |   |   |  |  | 1 |  |
| 601 396 | D | 1 | 2 | 1 |  | 1 |   |  |  |   |  |
| 601 434 | E | 1 | 1 |   |  |   |   |  |  |   |  |
| 601 440 | D | 1 | 2 |   |  |   | 1 |  |  |   |  |
| 601 446 | D | 1 | 1 | 1 |  |   |   |  |  |   |  |
| 601 495 | D | 1 | 2 | 1 |  |   |   |  |  |   |  |
| 601 502 | D | 1 | 2 |   |  |   | 1 |  |  |   |  |
| 601 580 | G | 1 | 2 | 1 |  |   |   |  |  |   |  |
| 601 582 | D | 1 | 2 |   |  | 1 | 1 |  |  |   |  |
| 601 654 | D | 1 | 2 | 1 |  |   |   |  |  |   |  |
| 601 675 | D | 1 |   |   |  | 1 |   |  |  |   |  |
| 601 916 | D | 1 |   | 1 |  | 1 |   |  |  |   |  |
| 601 953 | D | 1 |   |   |  | 1 |   |  |  |   |  |
| 602 249 | E | 1 |   | 1 |  |   |   |  |  |   |  |
| 602 251 | E | 1 |   | 1 |  |   |   |  |  |   |  |
| 602 314 | E | 1 |   | 1 |  |   | 1 |  |  |   |  |
| 602 320 | G | 1 | 1 | 1 |  | 1 |   |  |  |   |  |
| 602 322 | D | 1 | 1 | 1 |  | 1 | 1 |  |  |   |  |
| 602 337 | E | 1 |   | 1 |  |   |   |  |  |   |  |
| 602 338 | E | 1 |   | 1 |  |   |   |  |  |   |  |
| 602 339 | E | 1 |   | 1 |  |   |   |  |  |   |  |
| 602 340 | E | 1 |   | 1 |  |   |   |  |  |   |  |
| 602 341 | E | 1 |   | 1 |  |   |   |  |  |   |  |
| 602 343 | E | 1 |   | 1 |  |   |   |  |  |   |  |
| 602 344 | E | 1 |   | 1 |  |   |   |  |  |   |  |
| 602 345 | E | 1 |   | 1 |  |   |   |  |  |   |  |
| 602 347 | E | 1 |   | 1 |  |   |   |  |  |   |  |
| 602 349 | E | 1 |   | 1 |  |   |   |  |  |   |  |
| 602 356 | E | 1 |   | 1 |  |   |   |  |  |   |  |
| 602 358 | E | 1 | 1 | 1 |  |   |   |  |  |   |  |
| 602 361 | E | 1 |   | 1 |  |   |   |  |  |   |  |
| 602 367 | E | 1 |   | 1 |  |   |   |  |  |   |  |
| 602 369 | E | 1 |   | 1 |  |   |   |  |  |   |  |
| 602 386 | E | 1 |   | 1 |  |   |   |  |  |   |  |
| 602 388 | E | 1 |   | 1 |  |   |   |  |  |   |  |
| 602 390 | D | 1 | 2 | 1 |  |   |   |  |  |   |  |
| 602 392 | E | 1 | 1 |   |  |   |   |  |  |   |  |
| 602 406 | D | 1 | 2 | 1 |  |   |   |  |  |   |  |
| 602 412 | A | 1 | 1 |   |  |   |   |  |  |   |  |
| 602 414 | H | 2 | 1 | 1 |  |   |   |  |  | 1 |  |
| 602 416 | D | 1 |   | 1 |  |   |   |  |  |   |  |

L = lange Version      D = lange Version      En = long version      F = version longue      Pl = rozszerzona wersja      Cz = dlouhá verze      Es = versión larga  
S = kurze Version      S = kurze Version      S = short version      S = version courte      S = krótka wersja      S = krátká verze      S = versión corta

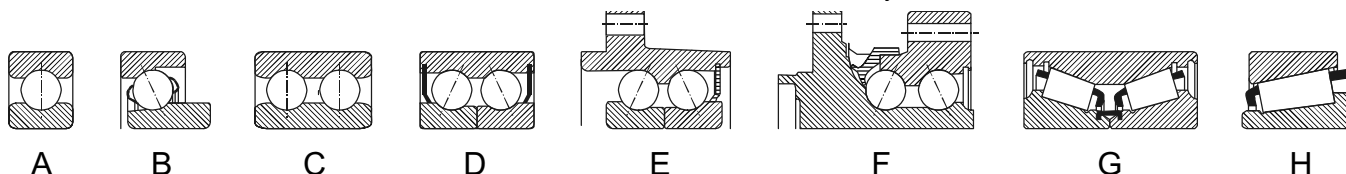



| OPTIMAL |   |   |   |   |  |   |   |   |   |   |
|---------|---|---|---|---|--|---|---|---|---|---|
| 602 418 | D | 1 | 1 | 1 |  |   |   |   |   |   |
| 602 430 | A | 1 | 1 |   |  |   |   | 1 |   | 1 |
| 602 512 | D | 1 | 1 |   |  |   |   |   |   |   |
| 602 539 | A | 1 | 1 |   |  |   |   | 1 |   |   |
| 602 541 | H | 2 | 1 | 1 |  |   |   |   | 1 | 1 |
| 602 584 | A | 2 | 1 | 1 |  |   |   |   |   |   |
| 602 645 | E | 1 |   | 1 |  |   |   |   |   |   |
| 602 669 | D | 1 | 1 | 1 |  | 1 |   |   |   | 1 |
| 602 681 | E | 1 |   | 1 |  |   |   |   |   |   |
| 602 858 | G | 1 | 1 | 1 |  | 1 |   |   |   |   |
| 602 859 | H | 2 | 1 | 1 |  |   |   |   |   |   |
| 602 865 | D | 1 | 2 |   |  |   | 1 |   |   |   |
| 602 881 | A | 1 |   | 1 |  |   |   |   |   | 2 |
| 602 926 | D | 1 | 1 | 1 |  | 1 |   |   |   |   |
| 602 927 | E | 1 |   | 1 |  |   |   |   |   |   |
| 602 937 | E | 1 |   | 1 |  |   |   |   |   |   |
| 602 955 | E | 1 |   | 1 |  |   |   |   |   |   |
| 602 956 | E | 1 |   | 1 |  |   |   |   |   |   |
| 681 259 | D | 1 |   |   |  | 1 |   |   |   |   |
| 681 261 | E | 1 |   | 1 |  |   |   |   |   |   |
| 681 303 | D | 1 |   |   |  | 1 | 1 |   |   |   |
| 681 325 | H | 2 | 2 | 1 |  |   |   |   |   |   |
| 681 375 | G | 1 |   | 1 |  | 1 |   |   |   |   |
| 681 471 | D | 1 |   | 1 |  | 1 |   |   |   |   |
| 681 504 | H | 2 | 2 | 1 |  |   |   |   |   |   |
| 681 506 | H | 2 | 2 | 1 |  |   |   |   |   |   |
| 681 640 | G | 1 | 2 | 1 |  |   |   |   |   |   |
| 681 907 | H | 2 | 1 |   |  |   | 1 |   |   |   |
| 681 909 | H | 2 | 1 | 1 |  |   |   |   |   |   |
| 681 910 | H | 2 | 1 | 1 |  |   |   |   |   |   |
| 681 919 | H | 2 | 1 |   |  |   | 1 |   |   |   |
| 681 923 | G | 1 |   |   |  |   |   |   |   |   |
| 681 924 | G | 1 |   |   |  |   |   |   |   |   |
| 682 169 | H | 1 | 1 |   |  |   | 1 | 2 | 1 | 1 |
| 682 175 | H | 1 | 2 |   |  |   | 1 | 1 | 1 | 1 |
| 682 263 | E | 1 |   |   |  |   |   |   |   | 1 |
| 682 305 | E | 1 |   | 1 |  |   |   |   |   |   |
| 682 327 | H | 2 | 1 | 1 |  |   |   |   |   |   |
| 682 329 | H | 2 | 1 | 1 |  |   |   |   |   |   |
| 682 420 | H | 2 | 1 | 1 |  |   |   |   |   |   |
| 682 422 | H | 2 | 1 | 1 |  |   |   |   |   |   |
| 682 437 | D | 1 |   | 1 |  | 1 |   |   |   |   |
| 682 490 | H | 2 | 1 | 1 |  |   |   |   |   |   |
| 682 492 | H | 2 | 1 | 1 |  |   |   |   |   |   |
| 682 508 | H | 2 | 1 | 1 |  |   |   |   |   |   |

L = lange Version  
 S = kurze Version  
 D = lange Version  
 En = long version  
 F = version longue  
 PI = rozszerzona wersja  
 Cz = dlouhá verze  
 Es = versió larga  
 S = kurze Version  
 En = short version  
 F = version courte  
 PI = krótká wersja  
 Cz = krátká verze  
 Es = versió corta

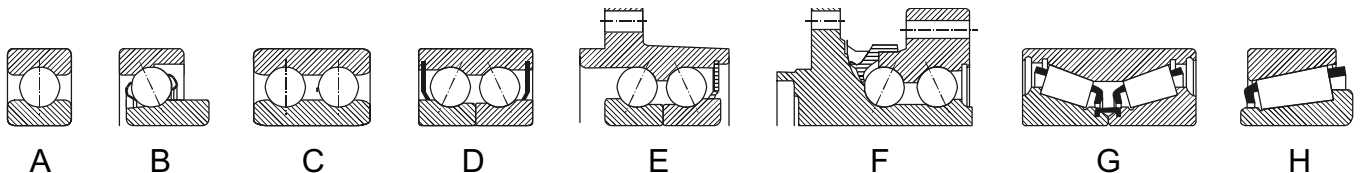

**SATZ-INHALT**  
**CONTENT OF KITS**  
**CONTENU DES KITS**



| OPTIMAL   |   |   |   |   |  |   |   |   |   |   |
|-----------|---|---|---|---|--|---|---|---|---|---|
| 682 510   | H | 2 | 1 | 1 |  |   |   |   |   |   |
| 682 642   | G | 1 | 1 | 1 |  |   |   |   |   |   |
| 682 848   | H | 1 | 1 |   |  |   | 1 | 2 | 1 | 1 |
| 682 867   | A | 1 | 1 |   |  |   |   | 1 |   |   |
| 682 892   | H | 1 | 2 |   |  |   |   | 1 |   |   |
| 682 920   | H | 2 | 1 |   |  |   |   |   | 2 | 1 |
| 682 925   | G | 1 |   |   |  |   |   |   |   |   |
| 700 245   | D | 1 |   | 1 |  | 1 |   |   |   |   |
| 700 310   | D | 1 |   | 1 |  | 1 |   |   |   |   |
| 701 247   | D | 1 |   | 1 |  |   |   |   |   |   |
| 701 302   | D | 1 |   | 1 |  | 1 |   |   |   |   |
| 701 307   | D | 1 |   | 1 |  | 1 |   |   |   |   |
| 701 319   | G | 1 |   | 1 |  | 1 |   |   |   |   |
| 701 326   | E | 1 |   | 1 |  |   |   |   |   |   |
| 701 332   | A | 2 |   | 1 |  |   |   |   |   |   |
| 701 346   | D | 1 |   | 1 |  | 1 |   |   |   |   |
| 701 374   | A | 2 |   | 1 |  |   |   |   |   |   |
| 701 404   | D | 1 |   | 1 |  |   |   |   |   |   |
| 701 424   | D | 1 |   | 1 |  |   |   |   |   |   |
| 701 432   | D | 1 | 2 | 1 |  |   |   |   |   |   |
| 701 726   | H | 2 | 2 | 1 |  |   |   |   |   |   |
| 701 728   | H | 2 | 1 | 1 |  |   |   |   |   |   |
| 701 852   | D | 1 |   | 1 |  | 1 |   |   |   |   |
| 701 860   | G | 1 |   | 1 |  | 1 |   |   |   |   |
| 701 914   | D | 1 |   | 1 |  | 1 |   |   |   |   |
| 701 975   | D | 1 |   | 1 |  |   |   |   |   |   |
| 701 977   | D | 1 |   | 1 |  | 1 |   |   |   |   |
| 701 978   | D | 1 |   | 1 |  | 1 |   |   |   |   |
| 702 309   | E | 1 |   | 1 |  |   |   |   |   |   |
| 702 311   | E | 1 |   | 1 |  |   |   |   |   |   |
| 702 312   | G | 1 |   | 1 |  | 1 |   |   |   |   |
| 702 312 L | G | 1 |   | 1 |  | 1 |   |   |   | 1 |
| 702 313   | E | 1 |   | 1 |  |   |   |   |   |   |
| 702 316   | G | 1 |   | 1 |  | 1 |   |   |   |   |
| 702 321   | E | 1 |   | 1 |  |   |   |   |   |   |
| 702 328   | H | 2 | 1 |   |  |   | 1 |   |   |   |
| 702 350   | H | 2 | 1 |   |  |   | 1 |   |   |   |
| 702 351   | E | 1 |   | 1 |  |   |   |   |   |   |
| 702 352   | G | 1 |   | 1 |  | 1 |   |   |   |   |
| 702 353   | E | 1 |   | 1 |  |   |   |   |   |   |
| 702 355   | E | 1 |   | 1 |  |   |   |   |   |   |
| 702 357   | E | 1 |   | 1 |  |   |   |   |   |   |
| 702 359   | E | 1 |   | 1 |  |   |   |   |   |   |
| 702 363   | D | 1 |   | 1 |  | 1 |   |   |   |   |
| 702 365   | E | 1 |   | 1 |  |   |   |   |   |   |

L = lange Version      D = lange Version      En = long version      F = version longue      Pl = rozszerzona wersja      Cz = dlouhá verze      Es = versión larga  
S = kurze Version      S = kurze Version      S = short version      S = version courte      S = krótka wersja      S = krátká verze      S = versión corta

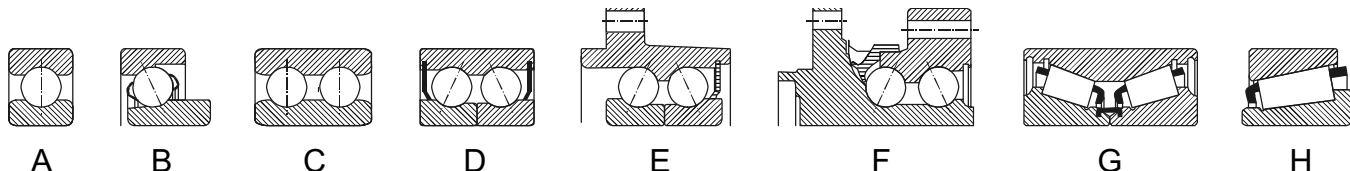

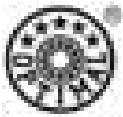

| OPTIMAL |   |   |   |   |  |   |  |   |  |  |
|---------|---|---|---|---|--|---|--|---|--|--|
| 702 380 | E | 1 |   | 1 |  |   |  |   |  |  |
| 702 426 | G | 1 |   | 1 |  | 1 |  |   |  |  |
| 702 436 | H | 2 | 1 |   |  |   |  |   |  |  |
| 702 448 | H | 1 | 2 |   |  |   |  | 1 |  |  |
| 702 452 | E | 1 |   | 1 |  |   |  |   |  |  |
| 702 456 | H | 2 | 1 | 1 |  |   |  |   |  |  |
| 702 462 | H | 1 | 1 |   |  |   |  | 1 |  |  |
| 702 494 | E | 1 |   | 1 |  |   |  |   |  |  |
| 702 514 | E | 1 |   | 1 |  |   |  |   |  |  |
| 702 537 | E | 1 |   | 1 |  |   |  |   |  |  |
| 702 550 | E | 1 |   | 1 |  |   |  |   |  |  |
| 702 552 | E | 1 |   | 1 |  |   |  |   |  |  |
| 702 586 | H | 2 | 1 | 1 |  |   |  |   |  |  |
| 702 603 | E | 1 |   |   |  |   |  |   |  |  |
| 702 692 | H | 2 | 1 | 1 |  |   |  |   |  |  |
| 702 765 | D | 1 |   | 1 |  | 1 |  |   |  |  |
| 702 817 | H | 2 | 1 |   |  |   |  | 1 |  |  |
| 702 846 | G | 1 |   | 1 |  | 1 |  |   |  |  |
| 702 850 | E | 1 |   | 1 |  |   |  |   |  |  |
| 702 866 | E | 1 |   | 1 |  |   |  |   |  |  |
| 702 915 | E | 1 |   | 1 |  |   |  |   |  |  |
| 702 957 | E | 1 |   | 1 |  |   |  |   |  |  |
| 702 958 | E | 1 |   | 1 |  |   |  |   |  |  |
| 702 959 | E | 1 |   | 1 |  |   |  |   |  |  |
| 702 960 | E | 1 |   | 1 |  |   |  |   |  |  |
| 702 976 | E | 1 |   |   |  |   |  |   |  |  |
| 702 982 | G | 1 |   | 1 |  | 1 |  |   |  |  |
| 702 983 | G | 1 |   |   |  | 1 |  |   |  |  |
| 800 304 | D | 1 | 2 | 1 |  | 1 |  |   |  |  |
| 800 366 | D | 1 |   | 1 |  | 1 |  |   |  |  |
| 800 398 | D | 1 |   | 1 |  | 1 |  |   |  |  |
| 800 400 | D | 1 |   | 1 |  | 1 |  |   |  |  |
| 800 408 | D | 1 |   | 2 |  |   |  |   |  |  |
| 801 171 | H | 2 | 1 | 1 |  |   |  |   |  |  |
| 801 173 | H | 2 | 1 | 1 |  |   |  |   |  |  |
| 801 238 | H | 2 | 1 |   |  |   |  | 1 |  |  |
| 801 267 | D | 1 |   | 1 |  | 1 |  |   |  |  |
| 801 269 | D | 1 |   | 1 |  |   |  |   |  |  |
| 801 342 | F | 1 |   | 1 |  |   |  |   |  |  |
| 801 354 | D | 1 | 2 | 1 |  |   |  |   |  |  |
| 801 360 | D | 1 |   | 1 |  | 1 |  |   |  |  |
| 801 362 | D | 1 |   | 1 |  | 1 |  |   |  |  |
| 801 364 | D | 1 |   | 1 |  | 1 |  |   |  |  |
| 801 372 | D | 1 |   | 2 |  |   |  |   |  |  |
| 801 376 | D | 1 |   | 1 |  | 1 |  |   |  |  |

L = lange Version      D = lange Version      En = long version      F = version longue      Pl = rozszerzona wersja      Cz = dlouhá verze      Es = versión larga  
 S = kurze Version      S = kurze Version      S = short version      S = version courte      S = krótka wersja      S = krátká verze      S = versión corta

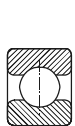

A



B

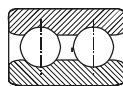

C

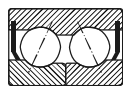

D

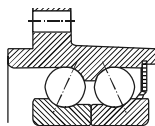

E

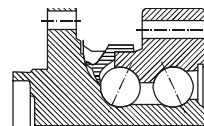

F



G



H









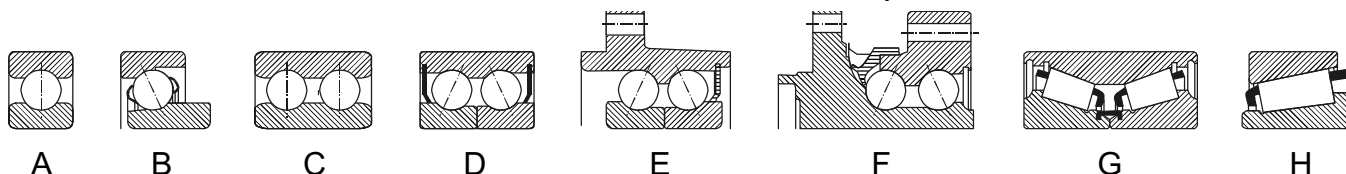

SATZ-INHALT  
CONTENT OF KITS  
CONTENU DES KITS



| OPTIMAL |   |   |   |   |   |   |   |   |  |  |
|---------|---|---|---|---|---|---|---|---|--|--|
| 801 382 | D | 1 |   | 2 |   |   |   |   |  |  |
| 801 402 | H | 2 | 1 | 2 |   |   |   |   |  |  |
| 801 428 | D | 1 |   | 2 |   |   |   |   |  |  |
| 801 438 | H | 2 | 1 | 1 |   | 1 |   |   |  |  |
| 801 442 | D | 1 |   | 1 |   |   |   |   |  |  |
| 801 450 | D | 1 |   | 1 | 1 |   |   |   |  |  |
| 801 478 | D | 1 | 1 | 2 |   |   |   |   |  |  |
| 801 500 | D | 1 |   | 1 | 1 |   |   |   |  |  |
| 801 538 | H | 2 | 1 | 1 |   |   |   |   |  |  |
| 801 543 | D | 1 |   | 1 | 1 |   |   |   |  |  |
| 801 554 | H | 2 | 1 |   |   | 1 |   |   |  |  |
| 801 574 | H | 2 | 1 | 2 |   |   |   |   |  |  |
| 801 588 | D | 1 | 2 |   |   |   |   |   |  |  |
| 801 618 | H | 2 | 1 |   |   | 1 |   |   |  |  |
| 801 644 | H | 2 | 1 | 1 |   |   |   |   |  |  |
| 801 656 | H | 2 | 2 | 1 |   |   |   |   |  |  |
| 801 694 | D | 1 |   | 1 | 1 |   |   |   |  |  |
| 801 698 | H | 2 | 1 | 2 |   |   |   |   |  |  |
| 801 730 | D | 1 |   | 1 | 1 |   |   |   |  |  |
| 801 746 | H | 2 | 1 |   |   |   |   |   |  |  |
| 801 750 | H | 2 | 1 | 1 |   |   |   |   |  |  |
| 801 836 | D | 1 |   | 1 | 1 |   |   |   |  |  |
| 801 838 | D | 1 |   | 1 | 1 |   |   |   |  |  |
| 801 880 | D | 1 |   | 1 | 1 |   |   |   |  |  |
| 801 950 | D | 1 |   | 1 | 1 |   |   |   |  |  |
| 801 961 | E | 1 |   | 1 | 4 |   |   |   |  |  |
| 801 970 | E | 1 |   | 1 |   |   |   |   |  |  |
| 801 972 | D | 1 |   | 1 | 1 |   |   |   |  |  |
| 801 974 | D | 1 |   | 1 | 1 |   |   |   |  |  |
| 802 233 | E | 1 |   |   | 4 |   |   |   |  |  |
| 802 265 | E | 1 |   |   |   |   |   |   |  |  |
| 802 271 | E | 1 |   |   |   |   |   |   |  |  |
| 802 315 | E | 1 |   | 1 |   |   |   |   |  |  |
| 802 318 | E | 1 |   | 1 |   |   |   |   |  |  |
| 802 324 | E | 1 |   | 1 |   |   |   |   |  |  |
| 802 330 | E | 1 |   | 1 |   |   |   |   |  |  |
| 802 331 | E | 1 |   | 1 |   |   |   |   |  |  |
| 802 335 | E | 1 |   | 1 |   |   |   |   |  |  |
| 802 368 | E | 1 |   | 1 |   |   |   |   |  |  |
| 802 370 | E | 1 |   | 1 |   |   |   |   |  |  |
| 802 378 | E | 1 |   | 1 |   |   |   |   |  |  |
| 802 394 | F | 1 |   |   |   |   |   |   |  |  |
| 802 444 | F | 1 | 1 |   |   |   |   |   |  |  |
| 802 454 | A | 1 | 1 |   |   |   |   | 1 |  |  |
| 802 464 | H | 2 | 2 | 1 |   |   | 1 |   |  |  |

L = lange Version      D = lange Version      En = long version      F = version longue      Pl = rozszerzona wersja      Cz = dlouhá verze      Es = versión larga  
S = kurze Version      S = kurze Version      S = short version      S = version courte      S = krótka wersja      S = krátká verze      S = versión corta



| OPTIMAL |  |  |  |  |  |  |  |  |  |  |  |
|---------|---|---|---|---|---|---|---|---|---|---|---|
| 802 480 | A   | 1   | 1   |   |   |   |   | 1   |   | 1   |   |
| 802 485 | E   | 1   |   | 1   |   |   |   |   |   |   |   |
| 802 488 | A   | 1   | 1   | 1   |   |   |   |   |   |   |   |
| 802 526 | E   | 1   |   | 1   |   |   |   |   |   |   |   |
| 802 528 | D   | 1   |   | 1   |   |   |   |   |   |   |   |
| 802 540 | D   | 1   |   | 1   |   | 1   |   |   |   |   |   |
| 802 542 | D   | 1   |   | 1   |   | 1   |   |   |   |   |   |
| 802 556 | D   | 1   |   | 1   |   | 1   |   |   |   |   |   |
| 802 558 | D   | 1   |   | 1   |   | 1   |   |   |   |   |   |
| 802 560 | E   | 1   |   | 1   |   |   |   |   |   |   |   |
| 802 562 | E   | 1   |   | 1   |   |   |   |   |   |   |   |
| 802 590 | A   | 1   | 1   |   |   |   |   | 1   |   | 1   |   |
| 802 601 | E   | 1   |   | 1   |   |   |   |   |   |   |   |
| 802 605 | E   | 1   |   | 1   |   |   |   |   |   |   |   |
| 802 620 | D   | 1   |   | 2   |   |   |   |   |   |   |   |
| 802 646 | A   | 1   | 1   |   |   |   |   | 1   |   |   |   |
| 802 652 | H   | 2   | 1   | 1   |   |   |   |   |   |   |   |
| 802 658 | D   | 1   |   | 1   |   |   |   |   |   |   |   |
| 802 660 | H   | 2   | 1   |   |   |   |   |   |   |   |   |
| 802 662 | H   | 2   | 1   |   |   |   |   |   |   |   |   |
| 802 720 | C   | 1   | 2   |   |   | 1   |   |   |   | 1   |   |
| 802 732 | H   | 2   | 1   |   |   | 1   |   |   |   |   |   |
| 802 740 | H   | 2   | 1   |   |   |   |   |   |   |   |   |
| 802 748 | H   | 2   | 1   |   |   |   |   |   |   |   |   |
| 802 826 | E   | 1   |   | 1   |   |   |   |   |   |   |   |
| 802 839 | E   | 1   |   | 1   |   |   |   |   |   |   |   |
| 802 870 | E   | 1   |   | 1   |   |   |   |   |   |   |   |
| 802 886 | E   | 1   |   | 1   |   |   |   |   |   |   |   |
| 802 888 | E   | 1   |   | 1   |   |   |   |   |   |   |   |
| 802 954 | D   | 1   | 2   | 1   |   | 2   |   |   |   |   |   |
| 802 980 | E   | 1   |   | 1   |   |   |   |   |   |   |   |
| 880 419 | H   | 2   | 1   |   |   | 1   |   |   | 2   |   |   |
| 880 421 | H   | 2   | 2   |   |   |   |   |   | 1   |   |   |
| 880 493 | H   | 2   | 1   |   |   | 1   |   |   |   |   |   |
| 880 525 | H   | 2   | 1   |   |   | 1   |   |   |   |   |   |
| 880 812 | H   | 2   | 2   |   |   | 1   |   |   | 1   | 1   |   |
| 880 912 | D   | 1   |   | 1   |   | 1   |   |   |   |   |   |
| 881 237 | D   | 1   |   |   |   | 1   |   |   |   |   |   |
| 881 489 | H   | 2   | 1   |   |   | 1   |   |   |   |   |   |
| 881 507 | B   | 2   | 2   |   |   | 2   | 1   |   |   |   |   |
| 881 523 | H   | 2   | 1   |   |   | 1   |   |   |   |   |   |
| 881 529 | H   | 2   | 1   |   |   | 1   |   |   |   |   |   |
| 881 534 | D   | 1   |   | 1   |   | 2   |   |   |   |   |   |
| 881 564 | H   | 2   | 1   |   |   |   |   |   |   |   |   |
| 881 592 | H   | 2   | 2   |   |   |   | 1   |   |   |   |   |

L = lange Version      D = lange Version      En = long version      F = version longue      Pl = rozszerzona wersja      Cz = dlouhá verze      Es = versión larga  
 S = kurze Version      S = kurze Version      S = short version      S = version courte      S = krótká wersja      S = krátká verze      S = versión corta

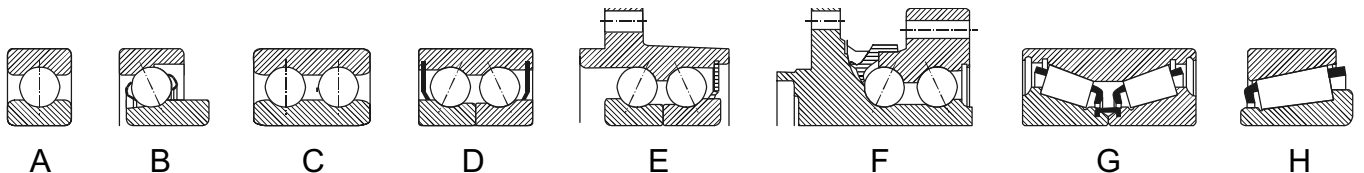

**SATZ-INHALT**  
**CONTENT OF KITS**  
**CONTENU DES KITS**







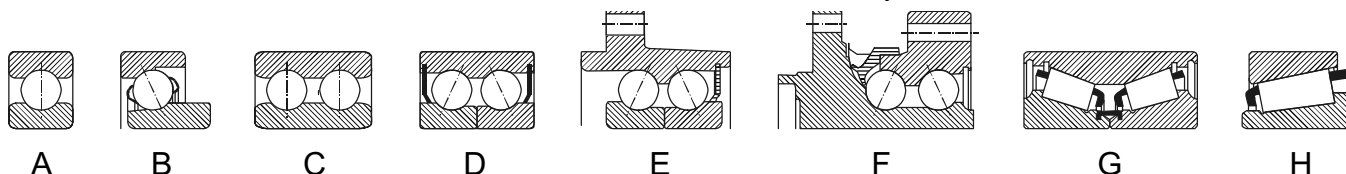





| OPTIMAL |   |   |   |   |  |   |   |   |   |  |
|---------|---|---|---|---|--|---|---|---|---|--|
| 881 594 | G | 1 |   | 1 |  | 2 |   |   |   |  |
| 881 609 | D | 1 |   | 1 |  | 1 |   |   |   |  |
| 881 622 | B | 2 | 2 | 1 |  |   | 1 | 1 |   |  |
| 881 704 | D | 1 |   | 1 |  | 1 |   |   |   |  |
| 881 725 | D | 1 |   | 1 |  | 1 |   |   |   |  |
| 881 879 | D | 1 | 2 | 1 |  |   |   |   |   |  |
| 882 167 | E | 1 |   | 2 |  |   |   |   |   |  |
| 882 235 | E | 1 |   |   |  |   |   |   |   |  |
| 882 463 | B | 2 | 1 | 2 |  |   |   |   |   |  |
| 882 483 | E | 1 |   | 2 |  |   |   |   |   |  |
| 882 487 | E | 1 |   | 1 |  |   |   |   |   |  |
| 882 491 | H | 2 | 2 |   |  |   |   |   |   |  |
| 882 531 | H | 1 | 2 |   |  | 1 |   |   | 1 |  |
| 882 596 | H | 2 | 1 |   |  |   |   | 1 |   |  |
| 882 598 | B | 2 | 1 |   |  |   | 1 |   |   |  |
| 882 607 | E | 1 |   | 1 |  |   |   |   |   |  |
| 882 611 | D | 1 |   | 1 |  | 1 |   |   |   |  |
| 882 613 | D | 1 |   | 1 |  | 1 |   |   |   |  |
| 882 624 | E | 1 |   | 1 |  |   |   |   |   |  |
| 882 626 | E | 1 |   | 1 |  |   |   |   |   |  |
| 882 643 | B | 2 | 1 |   |  |   | 1 |   |   |  |
| 882 664 | B | 2 | 1 |   |  |   | 1 |   |   |  |
| 882 666 | H | 2 | 2 |   |  |   | 1 |   |   |  |
| 882 727 | E | 1 |   | 1 |  |   |   |   |   |  |
| 882 729 | E | 1 |   | 1 |  |   |   |   |   |  |
| 882 896 | E | 1 |   | 1 |  |   |   |   |   |  |
| 891 333 | E | 1 |   | 1 |  |   |   |   |   |  |
| 891 466 | E | 1 |   | 1 |  |   |   |   |   |  |
| 891 469 | F | 1 |   |   |  |   |   |   |   |  |
| 891 477 | D | 1 | 2 | 1 |  | 1 |   |   |   |  |
| 891 482 | E | 1 |   | 1 |  |   |   |   |   |  |
| 891 484 | D | 1 |   | 1 |  | 2 |   |   |   |  |
| 891 486 | D | 1 |   | 1 |  | 2 |   |   |   |  |
| 891 496 | F | 1 |   | 1 |  |   |   |   |   |  |
| 891 509 | D | 1 |   | 1 |  |   |   |   |   |  |
| 891 520 | H | 2 | 1 |   |  |   | 1 |   |   |  |
| 891 522 | H | 2 | 1 |   |  |   | 1 |   |   |  |
| 891 524 | D | 1 |   | 1 |  |   |   |   |   |  |
| 891 536 | E | 1 |   | 1 |  |   |   |   |   |  |
| 891 544 | F | 1 |   | 1 |  |   |   |   |   |  |
| 891 546 | F | 1 |   | 1 |  |   |   |   |   |  |
| 891 628 | F | 1 |   | 1 |  |   |   |   |   |  |
| 891 630 | D | 1 |   | 1 |  | 2 |   |   |   |  |
| 891 706 | D | 1 |   | 1 |  |   |   |   |   |  |
| 891 731 | D | 1 | 2 | 1 |  | 1 |   |   |   |  |

L = lange Version      D = lange Version      En = long version      F = version longue      Pl = rozszerzona wersja      Cz = dlouhá verze      Es = versión larga  
S = kurze Version      S = kurze Version      S = short version      S = version courte      S = krótka wersja      S = krátká verze      S = versión corta





| OPTIMAL |  |  |  |  |  |  |  |  |  |  |  |
|---------|---|---|---|---|---|---|---|---|---|---|---|
| 891 822 | H   | 2   | 1   | 1   |   |   |   |   |   |   |   |
| 891 869 | F   | 1   |   |   |   |   |   |   |   |   |   |
| 891 878 | F   | 1   |   |   |   |   |   |   |   |   |   |
| 891 887 | D   | 1   |   | 1   |   | 2   |   |   |   |   |   |
| 892 458 | H   | 1   | 2   |   |   |   |   |   | 1   |   |   |
| 892 460 | H   | 1   | 2   |   |   |   |   |   | 1   |   |   |
| 892 468 | D   | 1   |   | 1   |   | 1   |   |   |   |   |   |
| 892 470 | E   | 1   |   | 1   |   |   |   |   |   |   |   |
| 892 472 | E   | 1   |   | 1   |   |   |   |   |   |   |   |
| 892 474 | D   | 1   |   | 1   |   | 1   |   |   |   |   |   |
| 892 476 | E   | 1   |   | 1   |   |   |   |   |   |   |   |
| 892 498 | E   | 1   |   | 1   |   |   |   |   |   |   |   |
| 892 668 | E   | 1   |   | 1   |   |   |   |   |   |   |   |
| 892 670 | E   | 1   |   | 1   |   |   |   |   |   |   |   |
| 892 733 | E   | 1   |   | 1   |   |   |   |   |   |   |   |
| 892 735 | E   | 1   |   | 1   |   |   |   |   |   |   |   |
| 892 806 | E   | 1   |   | 1   |   |   |   |   |   |   |   |
| 892 830 | H   | 2   | 1   | 1   |   |   |   |   |   |   |   |
| 892 843 | E   | 1   |   | 1   |   |   |   |   |   |   |   |
| 892 872 | F   | 1   |   |   |   |   |   |   |   |   |   |
| 892 929 | F   | 1   |   |   |   |   |   |   |   |   |   |
| 901 231 | D   | 1   |   | 1   |   | 1   |   |   |   |   |   |
| 901 425 | D   | 1   |   |   |   | 1   | 1   |   |   |   |   |
| 901 427 | A   | 2   | 2   |   |   |   | 1   |   |   |   |   |
| 901 429 | D   | 1   |   |   |   |   | 1   |   |   |   |   |
| 901 445 | H   | 2   | 1   |   |   |   |   |   |   |   |   |
| 901 461 | A   | 2   | 2   |   |   |   | 1   |   |   |   |   |
| 901 549 | H   | 2   | 2   |   |   | 1   |   |   |   |   |   |
| 901 876 | A   | 2   | 2   |   |   |   | 1   |   |   |   |   |
| 901 885 | H   | 2   | 1   |   |   |   | 1   |   |   |   |   |
| 901 890 | H   | 2   | 1   |   |   |   | 1   |   |   |   |   |
| 902 443 | A   | 1   | 2   |   |   |   |   |   | 1   |   |   |
| 902 457 | A   | 2   |   |   |   |   | 1   |   |   |   |   |
| 902 459 | A   | 2   |   |   |   |   | 1   |   |   |   |   |
| 902 547 | E   | 1   |   |   |   |   | 1   |   |   |   |   |
| 902 771 | E   | 1   |   |   |   |   | 1   |   |   |   |   |
| 902 855 | H   | 1   | 2   |   |   |   |   |   |   |   | 1   |
| 902 891 | A   | 1   | 1   |   |   |   |   |   | 1   |   |   |
| 902 901 | A   | 1   | 1   |   |   |   | 1   |   |   |   |   |
| 902 908 | A   | 1   | 1   |   |   |   |   |   | 2   |   |   |
| 902 999 | A   | 2   |   |   |   |   |   |   |   |   |   |
| 911 377 | D   | 1   |   | 1   |   | 1   |   |   |   |   |   |
| 911 383 | D   | 1   |   | 1   |   | 1   |   |   |   |   |   |
| 911 385 | E   | 1   |   | 1   |   |   |   |   |   |   |   |
| 911 387 | E   | 1   |   | 1   |   |   |   |   |   |   |   |

L = lange Version      D = lange Version      En = long version      F = version longue      Pl = rozszerzona wersja      Cz = dlouhá verze      Es = versión larga  
 S = kurze Version      S = kurze Version      S = short version      S = version courte      S = krótka wersja      S = krátká verze      S = versión corta

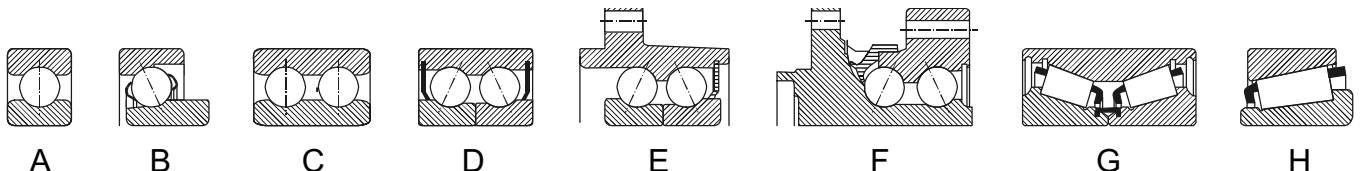

**SATZ-INHALT**  
**CONTENT OF KITS**  
**CONTENU DES KITS**







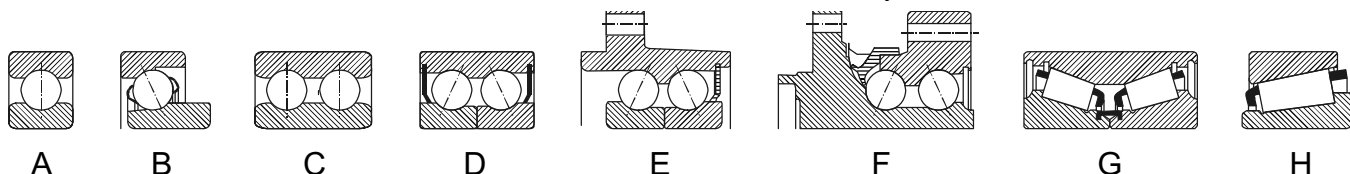





| OPTIMAL |   |   |   |   |  |   |  |  |   |   |
|---------|---|---|---|---|--|---|--|--|---|---|
| 911 399 | D | 1 |   | 1 |  | 1 |  |  |   |   |
| 911 600 | D | 1 |   | 1 |  | 1 |  |  |   |   |
| 911 647 | D | 1 |   | 1 |  | 1 |  |  |   |   |
| 911 777 | D | 1 |   | 1 |  | 1 |  |  |   |   |
| 911 802 | D | 1 |   | 1 |  | 1 |  |  |   |   |
| 911 968 | G | 1 |   |   |  |   |  |  |   |   |
| 911 969 | D | 1 |   |   |  |   |  |  |   |   |
| 912 191 | E | 1 |   | 1 |  |   |  |  |   |   |
| 912 193 | E | 1 |   | 1 |  |   |  |  |   |   |
| 912 292 | E | 1 |   |   |  |   |  |  |   |   |
| 912 294 | E | 1 |   |   |  |   |  |  |   |   |
| 912 295 | E | 1 |   |   |  |   |  |  |   |   |
| 912 296 | E | 1 |   |   |  |   |  |  |   |   |
| 912 401 | E | 1 |   | 1 |  |   |  |  |   |   |
| 912 403 | E | 1 |   | 1 |  |   |  |  |   |   |
| 912 423 | E | 1 |   | 1 |  |   |  |  |   |   |
| 912 473 | H | 2 | 1 |   |  |   |  |  | 1 |   |
| 912 515 | H | 2 | 1 |   |  |   |  |  | 2 |   |
| 912 518 | E | 1 |   | 1 |  |   |  |  |   |   |
| 912 527 | E | 1 |   | 1 |  |   |  |  |   |   |
| 912 530 | E | 1 |   | 1 |  |   |  |  |   |   |
| 912 532 | E | 1 |   | 1 |  |   |  |  |   |   |
| 912 545 | D | 1 |   | 1 |  |   |  |  |   |   |
| 912 775 | E | 1 |   | 1 |  |   |  |  |   |   |
| 912 803 | E | 1 |   | 1 |  |   |  |  |   |   |
| 912 804 | E | 1 |   | 1 |  |   |  |  |   |   |
| 912 809 | D | 1 |   | 1 |  | 1 |  |  |   |   |
| 912 991 | E | 1 |   |   |  |   |  |  |   |   |
| 912 992 | E | 1 |   |   |  |   |  |  |   |   |
| 920 752 | H | 2 | 1 |   |  |   |  |  | 1 |   |
| 921 215 | D | 1 |   |   |  | 1 |  |  |   |   |
| 921 553 | G | 1 |   | 1 |  | 1 |  |  |   |   |
| 921 555 | H | 2 | 2 |   |  |   |  |  |   |   |
| 921 895 | D | 1 |   |   |  | 1 |  |  |   |   |
| 921 906 | D | 1 |   |   |  | 1 |  |  |   |   |
| 922 179 | E | 1 |   | 1 |  |   |  |  |   |   |
| 922 181 | E | 1 |   | 1 |  |   |  |  |   |   |
| 922 187 | H | 2 | 1 |   |  |   |  |  | 1 |   |
| 922 189 | E | 1 |   | 1 |  |   |  |  |   |   |
| 922 217 | E | 1 |   | 1 |  |   |  |  |   |   |
| 922 219 | E | 1 |   | 1 |  |   |  |  |   |   |
| 922 221 | F | 1 |   |   |  |   |  |  |   |   |
| 922 223 | F | 1 |   |   |  |   |  |  |   |   |
| 922 395 | H | 2 | 1 |   |  |   |  |  | 1 |   |
| 922 439 | A | 1 | 1 |   |  |   |  |  |   | 1 |

L = lange Version      D = lange Version      En = long version      F = version longue      Pl = rozszerzona wersja      Cz = dlouhá verze      Es = versión larga  
S = kurze Version      S = kurze Version      S = short version      S = version courte      S = krótka wersja      S = krátká verze      S = versión corta



Alle in diesem Katalog genannten Original-Nummern der Kfz-Hersteller sind ausschließlich zu Vergleichszwecken bestimmt und dürfen in Rechnungen an Wagenbesitzer nicht verwendet werden.  
All original numbers from automobile manufacturers listed in this catalogue are for comparison purposes only and may not be used in invoices to car owners.  
Nachdruck, auch auszugsweise, nur mit unserer schriftlichen Genehmigung gestattet. - Full or partial reproduction only permitted with our approval.  
Les références des constructeurs n'ont aucune valeur et ne sont indiquées qu'à titre d'identification. La reproduction complète ou partielle de notre catalogue est interdite sans notre accord écrit.

| OPTIMAL |  |  |  |  |  |  |  |  |  |  |  |
|---------|---|---|---|---|---|---|---|---|---|---|---|
| 922 441 | H   | 2   | 1   | 1   |   |   |   |   |   |   |   |
| 922 557 | H   | 1   | 2   |   |   |   |   | 1   |   |   |   |
| 922 697 | E   | 1   |   | 1   |   |   |   |   |   |   |   |
| 922 781 | E   | 1   |   | 1   |   |   |   |   |   |   |   |
| 922 783 | E   | 1   |   | 1   |   |   |   |   |   |   |   |
| 922 787 | E   | 1   |   | 1   |   |   |   |   |   |   |   |
| 922 789 | E   | 1   |   | 1   |   |   |   |   |   |   |   |
| 922 854 | H   | 1   | 2   |   |   |   |   | 1   |   |   |   |
| 922 871 | E   | 1   |   |   |   |   |   |   |   |   |   |
| 922 875 | E   | 1   |   |   |   |   |   |   |   |   |   |
| 922 877 | G   | 1   |   |   | 1   |   |   |   |   |   |   |
| 922 882 | H   | 2   | 1   | 1   |   |   |   |   |   |   |   |
| 922 921 | E   | 1   |   | 1   |   |   |   |   |   |   |   |
| 922 979 | E   | 1   |   |   |   |   |   |   |   |   |   |
| 931 649 | H   | 2   | 1   |   |   | 1   |   |   |   |   |   |
| 931 930 | H   | 2   | 1   |   |   | 1   |   |   |   |   |   |
| 931 931 | H   | 2   | 1   |   |   | 1   |   |   |   |   |   |
| 931 932 | H   | 2   | 1   |   |   | 1   |   |   |   |   |   |
| 932 665 | H   | 2   | 2   |   |   |   |   |   |   |   |   |
| 932 794 | H   | 1   | 2   |   |   |   |   |   |   |   |   |
| 932 864 | A   | 1   | 2   |   | 1   |   |   | 1   |   |   |   |
| 932 933 | H   | 1   | 2   |   |   |   |   |   |   |   |   |
| 932 934 | A   | 1   | 1   |   | 1   |   |   | 1   |   |   |   |
| 940 371 | D   | 1   | 1   | 1   |   | 1   |   |   |   |   |   |
| 940 632 | H   | 2   | 2   | 1   |   |   |   |   |   |   |   |
| 941 281 | H   | 1   | 1   |   |   |   |   |   |   |   |   |
| 941 565 | H   | 2   | 1   |   |   | 1   |   |   |   |   |   |
| 941 602 | G   | 1   | 1   | 1   |   | 1   |   |   |   |   |   |
| 941 634 | H   | 2   | 2   | 1   |   |   |   |   |   |   |   |
| 941 636 | H   | 2   | 2   | 1   |   |   |   |   |   |   |   |
| 941 687 | H   | 2   | 2   |   |   |   |   |   |   |   |   |
| 941 700 | D   | 1   | 1   | 1   |   | 1   |   |   |   |   |   |
| 941 734 | D   | 1   |   | 1   |   |   |   |   |   |   |   |
| 941 784 | D   | 1   | 1   | 1   |   | 1   |   |   |   |   |   |
| 941 840 | D   | 1   | 1   | 1   |   | 1   |   |   |   |   |   |
| 941 842 | E   | 1   |   | 1   |   |   |   |   |   |   |   |
| 941 862 | E   | 1   |   | 1   |   |   |   |   |   |   |   |
| 941 874 | H   | 2   | 2   | 1   |   |   |   |   |   |   |   |
| 941 941 | G   | 1   | 1   | 1   |   | 1   |   |   |   |   |   |
| 941 951 | E   | 1   |   | 1   |   |   |   |   |   |   |   |
| 941 963 | H   | 2   | 1   |   |   |   |   |   |   |   |   |
| 941 967 | E   | 1   |   |   |   |   |   |   |   |   |   |
| 942 177 | E   | 1   |   |   |   |   |   |   |   |   |   |
| 942 273 | E   | 1   |   |   |   |   |   |   |   |   |   |
| 942 291 | E   | 1   |   |   |   |   |   |   |   |   |   |

L = lange Version      D = lange Version      En = long version      F = version longue      Pl = rozszerzona wersja      Cz = dlouhá verze      Es = versión larga  
 S = kurze Version      S = kurze Version      S = short version      S = version courte      S = krótká wersja      S = krátká verze      S = versión corta

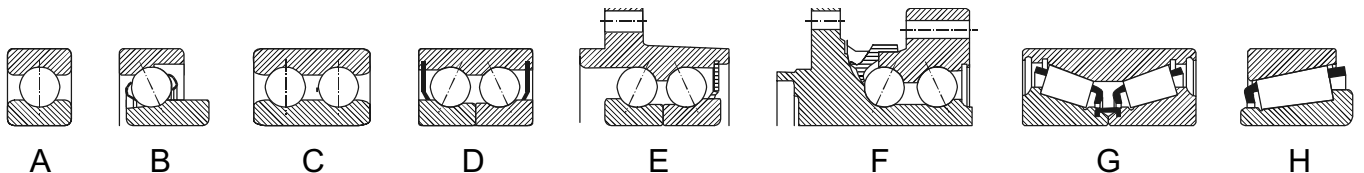

**SATZ-INHALT**  
**CONTENT OF KITS**  
**CONTENU DES KITS**



| OPTIMAL |   |   |   |   |   |   |  |   |  |   |
|---------|---|---|---|---|---|---|--|---|--|---|
| 942 381 | E | 1 |   | 1 |   |   |  |   |  |   |
| 942 566 | H | 2 | 1 | 1 |   |   |  |   |  |   |
| 942 568 | H | 2 | 1 | 1 |   |   |  |   |  |   |
| 942 569 | E | 1 |   | 1 |   |   |  |   |  |   |
| 942 570 | H | 2 | 1 | 1 |   |   |  |   |  |   |
| 942 619 | A | 1 | 1 |   |   |   |  | 1 |  |   |
| 942 651 | H | 2 | 2 |   |   |   |  |   |  |   |
| 942 672 | G | 1 | 1 | 1 | 1 |   |  |   |  |   |
| 942 674 | H | 2 | 1 | 1 |   |   |  |   |  |   |
| 942 695 | H | 1 | 2 |   |   |   |  |   |  |   |
| 942 736 | G | 1 | 1 | 1 | 1 |   |  |   |  |   |
| 942 738 | D | 1 |   | 1 | 1 |   |  |   |  |   |
| 942 768 | H | 2 | 1 | 1 |   |   |  |   |  |   |
| 942 770 | H | 2 | 1 | 1 |   |   |  |   |  |   |
| 942 773 | E | 1 |   | 1 |   |   |  |   |  |   |
| 942 818 | H | 2 | 1 | 1 |   |   |  |   |  |   |
| 942 820 | H | 2 | 1 | 1 |   |   |  |   |  |   |
| 942 942 | H | 2 | 1 | 1 |   |   |  |   |  |   |
| 942 987 | G | 1 | 1 | 1 | 1 |   |  |   |  |   |
| 942 988 | D | 1 |   | 1 | 1 |   |  |   |  |   |
| 942 989 | D | 1 | 1 |   | 1 |   |  | 1 |  |   |
| 951 282 | D | 1 |   |   | 1 |   |  |   |  |   |
| 951 284 | H | 1 | 1 |   |   |   |  |   |  |   |
| 951 409 | D | 1 | 2 |   | 1 | 1 |  |   |  |   |
| 951 449 | D | 1 | 2 |   | 1 | 1 |  |   |  |   |
| 951 604 | D | 1 | 2 |   |   | 1 |  |   |  |   |
| 951 606 | H | 2 | 2 |   |   | 1 |  |   |  |   |
| 951 708 | H | 2 | 1 |   |   | 1 |  |   |  |   |
| 951 722 | H | 2 | 1 |   | 1 |   |  |   |  |   |
| 951 756 | H | 2 | 1 |   |   | 1 |  |   |  |   |
| 951 962 | D | 1 |   |   | 1 |   |  |   |  |   |
| 951 971 | D | 1 | 2 |   |   |   |  |   |  |   |
| 952 279 | E | 1 |   |   |   |   |  |   |  |   |
| 952 297 | G | 1 | 2 |   |   |   |  | 1 |  | 1 |
| 952 405 | E | 1 |   |   |   |   |  |   |  |   |
| 952 415 | E | 1 |   | 1 |   |   |  |   |  |   |
| 952 417 | E | 1 |   | 1 |   |   |  |   |  |   |
| 952 551 | E | 1 |   |   |   |   |  |   |  |   |
| 952 608 | E | 1 |   | 1 |   |   |  |   |  |   |
| 952 661 | H | 1 | 2 |   |   |   |  |   |  | 1 |
| 952 676 | H | 2 | 1 |   |   |   |  |   |  |   |
| 952 678 | H | 2 | 1 | 1 |   |   |  |   |  |   |
| 952 679 | A | 2 | 1 | 1 |   |   |  |   |  |   |
| 952 710 | H | 2 | 1 | 1 |   |   |  |   |  |   |
| 952 758 | H | 1 | 2 |   |   |   |  |   |  | 1 |

L = lange Version      D = lange Version      En = long version      F = version longue      Pl = rozszerzona wersja      Cz = dlouhá verze      Es = versión larga  
S = kurze Version      S = kurze Version      S = short version      S = version courte      S = krótka wersja      S = krátká verze      S = versión corta

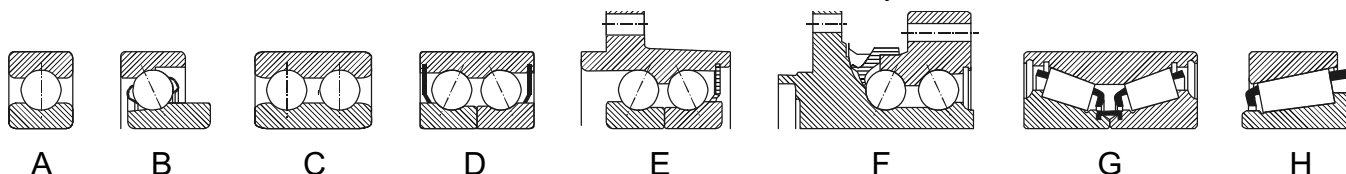

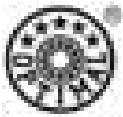

| OPTIMAL |   |   |   |   |   |   |   |   |  |   |
|---------|---|---|---|---|---|---|---|---|--|---|
| 952 769 | G | 1 | 2 |   |   |   |   | 1 |  | 1 |
| 952 832 | A | 1 | 1 |   |   |   |   | 1 |  |   |
| 952 935 | H | 1 | 2 |   |   |   |   | 1 |  | 1 |
| 952 936 | H | 1 | 2 |   |   |   |   | 1 |  | 1 |
| 952 993 | A | 2 | 1 |   |   |   |   |   |  |   |
| 952 994 | E | 1 |   |   |   |   |   |   |  |   |
| 952 995 | E | 1 |   |   |   |   |   |   |  |   |
| 952 996 | A | 1 | 1 |   |   |   |   | 1 |  |   |
| 952 997 | F | 1 |   |   |   |   |   |   |  |   |
| 960 578 | D | 1 | 1 |   | 1 | 1 |   |   |  |   |
| 960 638 | D | 1 | 2 |   | 2 | 1 |   |   |  |   |
| 960 702 | G | 1 | 2 |   |   | 1 |   |   |  |   |
| 961 229 | D | 1 | 1 |   |   |   |   |   |  |   |
| 961 411 | H | 2 | 2 |   |   |   |   |   |  |   |
| 961 479 | D | 1 | 2 |   | 1 | 1 |   |   |  |   |
| 961 503 | H | 2 | 1 |   |   | 1 |   |   |  |   |
| 961 576 | G | 1 | 2 |   |   | 1 |   |   |  |   |
| 961 610 | D | 1 | 2 |   | 1 | 1 |   |   |  |   |
| 961 648 | D | 1 | 2 |   | 2 | 1 |   |   |  |   |
| 961 677 | H | 2 | 1 |   |   | 1 |   |   |  | 1 |
| 961 680 | H | 2 | 2 |   |   | 1 |   |   |  |   |
| 961 701 | G | 1 | 2 |   | 2 | 1 |   |   |  |   |
| 961 724 | H | 2 | 1 |   |   | 1 |   |   |  |   |
| 961 751 | E | 1 |   |   |   | 1 |   |   |  |   |
| 961 753 | G | 1 | 2 | 1 |   | 2 |   |   |  |   |
| 961 759 | D | 1 |   |   |   | 1 | 1 |   |  |   |
| 961 796 | H | 2 | 2 |   |   | 1 |   |   |  |   |
| 961 801 | H | 2 | 2 |   |   |   |   |   |  |   |
| 961 808 | H | 2 | 1 |   |   | 1 |   |   |  |   |
| 961 883 | H | 2 | 2 |   |   | 1 |   |   |  |   |
| 961 900 | D | 1 |   | 1 |   | 1 |   |   |  |   |
| 961 904 | H | 2 | 1 |   |   |   |   |   |  |   |
| 961 964 | E | 1 |   |   |   |   |   |   |  |   |
| 961 965 | H | 2 | 2 |   |   |   |   |   |  |   |
| 962 241 | E | 1 |   |   |   |   |   |   |  |   |
| 962 286 | A | 2 | 1 |   |   |   |   |   |  |   |
| 962 413 | G | 1 | 2 |   |   |   |   |   |  |   |
| 962 435 | H | 1 | 2 |   |   |   |   |   |  |   |
| 962 481 | E | 1 |   |   |   | 1 |   |   |  |   |
| 962 548 | E | 1 |   |   |   | 1 |   |   |  |   |
| 962 682 | H | 2 | 1 |   |   | 1 |   |   |  |   |
| 962 684 | A | 1 | 1 |   |   |   |   |   |  |   |
| 962 686 | H | 1 | 1 |   |   |   |   | 1 |  |   |
| 962 703 | E | 1 |   |   |   | 1 |   |   |  |   |
| 962 705 | E | 1 |   |   |   | 1 |   |   |  |   |

L = lange Version      D = lange Version      En = long version      F = version longue      Pl = rozszerzona wersja      Cz = dlouhá verze      Es = versión larga  
 S = kurze Version      S = kurze Version      S = short version      S = version courte      S = krótka wersja      S = krátká verze      S = versión corta

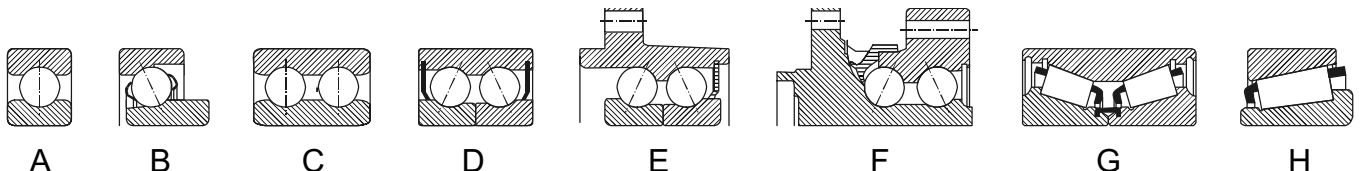

**SATZ-INHALT**  
**CONTENT OF KITS**  
**CONTENU DES KITS**



| OPTIMAL |   |   |   |   |   |   |   |   |   |  |
|---------|---|---|---|---|---|---|---|---|---|--|
| 962 712 | E | 1 |   |   |   |   |   |   |   |  |
| 962 714 | E | 1 |   |   |   |   |   |   |   |  |
| 962 716 | D | 1 | 1 |   | 1 | 1 |   |   |   |  |
| 962 718 | G | 1 | 1 |   | 1 | 1 |   |   |   |  |
| 962 755 | E | 1 |   |   |   | 1 |   |   |   |  |
| 962 757 | F | 1 |   |   |   | 1 |   |   |   |  |
| 962 760 | H | 2 | 1 |   |   | 1 |   |   |   |  |
| 962 762 | H | 2 | 1 |   |   | 1 |   |   |   |  |
| 962 776 | H | 2 | 1 |   |   | 1 |   |   |   |  |
| 962 779 | E | 1 |   |   |   | 1 |   |   |   |  |
| 962 807 | E | 1 |   | 1 |   |   |   |   |   |  |
| 962 810 | E | 1 |   |   |   | 1 |   |   |   |  |
| 962 841 | H | 1 | 2 |   |   |   |   |   |   |  |
| 962 847 | H | 2 | 2 |   |   |   |   |   |   |  |
| 962 853 | E | 1 |   |   |   | 1 |   |   |   |  |
| 962 873 | E | 1 |   |   |   |   |   |   |   |  |
| 962 897 | D | 1 |   |   |   |   |   |   |   |  |
| 962 903 | E | 1 |   |   |   |   |   |   |   |  |
| 962 905 | H | 1 | 2 |   |   |   |   |   |   |  |
| 962 949 | A | 1 | 1 |   |   |   | 1 |   |   |  |
| 962 981 | E | 1 |   |   |   |   |   |   |   |  |
| 962 984 | G | 1 |   |   |   |   |   |   |   |  |
| 962 985 | G | 1 | 2 |   |   |   |   |   | 1 |  |
| 962 986 | E | 1 |   |   |   |   |   |   |   |  |
| 971 285 | D | 1 | 2 |   |   |   |   |   |   |  |
| 971 290 | H | 2 | 1 |   |   |   |   |   |   |  |
| 971 391 | D | 1 |   |   | 2 | 1 |   |   |   |  |
| 971 393 | D | 1 |   |   | 1 | 1 |   |   |   |  |
| 971 451 | H | 2 | 1 |   | 1 |   |   | 1 |   |  |
| 971 455 | A | 2 | 1 |   |   | 1 |   |   |   |  |
| 971 567 | D | 1 |   |   | 1 | 1 |   |   |   |  |
| 971 575 | D | 1 | 2 |   | 1 | 1 |   |   |   |  |
| 971 612 | G | 1 | 2 |   | 1 |   |   |   |   |  |
| 971 615 | A | 2 | 2 |   |   | 1 |   |   |   |  |
| 971 631 | A | 2 | 2 |   |   | 1 |   |   |   |  |
| 971 635 | A | 2 | 2 |   |   |   |   |   |   |  |
| 971 641 | A | 2 | 2 |   |   | 1 |   |   |   |  |
| 971 707 | G | 1 | 2 | 1 | 1 |   |   |   |   |  |
| 971 711 | D | 1 | 2 | 1 | 1 |   |   |   |   |  |
| 971 723 | D | 1 | 2 | 1 | 1 |   |   |   |   |  |
| 971 917 | H | 2 | 2 | 1 |   |   | 1 |   |   |  |
| 971 940 | D | 1 |   | 1 | 1 |   |   |   |   |  |
| 972 275 | A | 1 | 1 |   |   |   | 2 |   |   |  |
| 972 299 | E | 1 |   |   |   |   |   |   |   |  |
| 972 389 | H | 2 | 1 |   |   | 1 |   |   |   |  |

L = lange Version      D = lange Version      En = long version      F = version longue      Pl = rozszerzona wersja      Cz = dlouhá verze      Es = versión larga  
S = kurze Version      S = kurze Version      S = short version      S = version courte      S = krótka wersja      S = krátká verze      S = versión corta

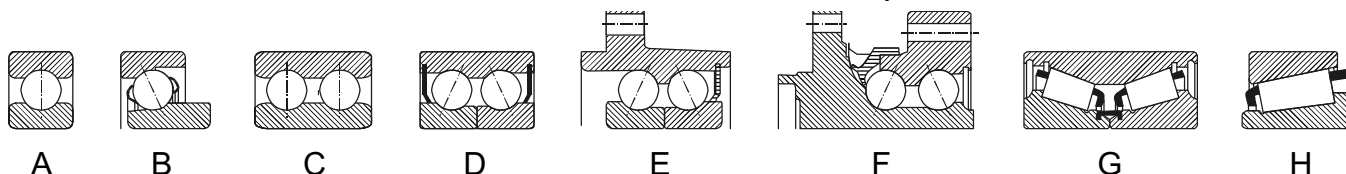



| OPTIMAL   |   |   |   |   |  |   |   |   |  |  |
|-----------|---|---|---|---|--|---|---|---|--|--|
| 972 397   | F | 1 |   |   |  | 1 |   |   |  |  |
| 972 453   | A | 2 |   |   |  | 1 |   |   |  |  |
| 972 465   | G | 1 | 2 |   |  | 1 |   |   |  |  |
| 972 571   | A | 1 | 1 |   |  |   |   | 1 |  |  |
| 972 573   | A | 1 | 1 |   |  |   |   | 1 |  |  |
| 972 633   | H | 2 | 1 |   |  |   |   |   |  |  |
| 972 637   | H | 2 | 1 |   |  |   |   |   |  |  |
| 972 639   | A | 2 | 2 |   |  |   |   |   |  |  |
| 972 688   | A | 1 | 2 |   |  |   |   | 1 |  |  |
| 972 709   | G | 1 | 3 | 1 |  | 1 |   |   |  |  |
| 972 715   | D | 1 | 1 | 1 |  | 1 |   |   |  |  |
| 972 717   | E | 1 |   | 1 |  |   |   |   |  |  |
| 972 719   | A | 2 |   | 1 |  |   |   |   |  |  |
| 972 721   | A | 2 |   | 1 |  |   |   |   |  |  |
| 972 918   | H | 2 | 1 | 1 |  |   | 1 |   |  |  |
| 972 973   | E | 1 |   |   |  |   |   |   |  |  |
| 980 614   | D | 1 | 2 |   |  | 1 |   |   |  |  |
| 981 199   | G | 1 |   | 1 |  | 1 |   |   |  |  |
| 981 203   | H | 1 | 2 |   |  |   |   |   |  |  |
| 981 283   | D | 1 | 1 |   |  | 1 |   |   |  |  |
| 981 407   | D | 1 | 2 |   |  | 1 | 1 |   |  |  |
| 981 447   | H | 2 | 1 |   |  |   | 1 |   |  |  |
| 981 475   | D | 1 |   |   |  | 1 | 1 |   |  |  |
| 981 499   | H | 2 | 1 |   |  | 1 |   |   |  |  |
| 981 533   | H | 2 | 2 |   |  |   |   |   |  |  |
| 981 535   | H | 2 | 1 |   |  |   | 1 |   |  |  |
| 981 572   | D | 1 | 2 |   |  | 1 | 1 |   |  |  |
| 981 616   | D | 1 | 2 |   |  | 1 | 1 |   |  |  |
| 981 683   | H | 2 | 1 |   |  | 1 |   |   |  |  |
| 981 690   | D | 1 | 2 |   |  | 1 | 1 |   |  |  |
| 981 742   | D | 1 | 2 |   |  | 1 | 1 |   |  |  |
| 981 743   | D | 1 | 2 |   |  | 1 | 1 |   |  |  |
| 981 744   | D | 1 | 2 |   |  |   | 1 |   |  |  |
| 981 745   | D | 1 | 2 |   |  | 1 | 1 |   |  |  |
| 981 747   | D | 1 | 1 | 1 |  | 1 |   |   |  |  |
| 981 747 S | D | 1 |   | 1 |  |   |   |   |  |  |
| 981 763   | D | 1 | 2 |   |  | 1 | 1 |   |  |  |
| 981 790   | H | 2 | 1 |   |  |   | 1 |   |  |  |
| 981 798   | H | 2 | 1 |   |  |   | 1 |   |  |  |
| 981 805   | D | 1 | 1 | 1 |  | 1 |   |   |  |  |
| 981 814   | H | 2 | 1 |   |  |   | 1 |   |  |  |
| 981 849   | D | 1 | 1 | 1 |  | 1 |   |   |  |  |
| 981 851   | D | 1 | 2 |   |  | 1 | 1 |   |  |  |
| 981 856   | D | 1 | 2 |   |  | 1 | 1 |   |  |  |
| 981 868   | D | 1 | 2 |   |  | 1 | 1 |   |  |  |

L = lange Version      D = lange Version      En = long version      F = version longue      Pl = rozszerzona wersja      Cz = dlouhá verze      Es = versión larga  
S = kurze Version      S = kurze Version      S = short version      S = version courte      S = krótká wersja      S = krátká verze      S = versión corta

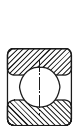

A



B

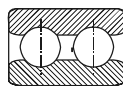

C

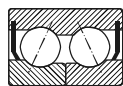

D

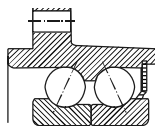

E

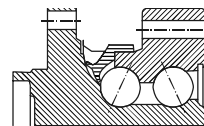

F



G

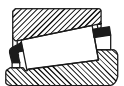

H

**SATZ-INHALT**  
**CONTENT OF KITS**  
**CONTENU DES KITS**



| OPTIMAL |   |   |   |   |  |   |   |   |  |   |
|---------|---|---|---|---|--|---|---|---|--|---|
| 981 938 | D | 1 |   | 1 |  | 1 |   |   |  |   |
| 981 944 | G | 1 | 1 | 1 |  | 1 |   |   |  |   |
| 981 947 | D | 1 |   |   |  | 1 | 1 |   |  |   |
| 981 952 | G | 1 | 2 |   |  |   |   |   |  |   |
| 981 966 | H | 2 | 1 | 1 |  |   |   |   |  |   |
| 982 195 | F | 1 |   |   |  |   |   |   |  |   |
| 982 201 | A | 1 |   |   |  |   |   |   |  | 1 |
| 982 211 | E | 1 |   |   |  |   |   |   |  |   |
| 982 225 | E | 1 |   |   |  |   |   |   |  |   |
| 982 287 | G | 1 |   |   |  | 1 | 1 |   |  |   |
| 982 288 | D | 1 | 1 |   |  |   |   |   |  | 1 |
| 982 289 | D | 1 |   |   |  | 1 | 1 |   |  |   |
| 982 373 | H | 2 | 2 | 1 |  | 1 |   |   |  |   |
| 982 379 | D | 1 |   | 1 |  |   |   |   |  | 1 |
| 982 431 | E | 1 |   | 1 |  |   |   |   |  | 1 |
| 982 559 | D | 1 | 2 |   |  | 1 | 1 |   |  |   |
| 982 561 | H | 2 | 1 |   |  |   | 1 |   |  |   |
| 982 581 | H | 1 | 1 |   |  |   |   |   |  |   |
| 982 685 | A | 1 | 1 |   |  |   |   | 1 |  |   |
| 982 737 | D | 1 | 2 |   |  | 1 |   |   |  |   |
| 982 762 | E | 1 |   |   |  |   | 1 |   |  |   |
| 982 764 | A | 1 | 1 |   |  |   |   | 1 |  |   |
| 982 766 | D | 1 | 1 | 1 |  |   |   |   |  | 1 |
| 982 774 | A | 1 | 2 |   |  | 1 |   | 1 |  |   |
| 982 778 | D | 1 | 1 | 1 |  |   |   |   |  | 1 |
| 982 780 | D | 1 | 1 | 1 |  |   |   |   |  | 1 |
| 982 800 | A | 1 | 1 |   |  |   |   | 1 |  |   |
| 982 811 | H | 2 | 2 |   |  |   |   |   |  |   |
| 982 813 | G | 1 | 2 |   |  |   |   | 2 |  | 1 |
| 982 816 | H | 2 | 1 |   |  |   | 1 |   |  |   |
| 982 857 | E | 1 |   | 1 |  |   |   |   |  | 1 |
| 982 884 | A | 1 | 2 |   |  | 1 |   | 1 |  |   |
| 982 939 | F | 1 |   |   |  |   |   |   |  |   |
| 982 945 | G | 1 | 2 |   |  |   |   |   |  |   |
| 982 948 | E | 1 |   | 1 |  |   |   |   |  | 1 |
| 991 655 | D | 1 |   | 1 |  |   |   |   |  |   |
| 991 657 | D | 1 |   | 1 |  |   |   |   |  |   |
| 991 749 | D | 1 |   | 1 |  |   |   |   |  |   |
| 991 788 | D | 1 |   | 1 |  |   |   |   |  |   |
| 991 898 | F | 1 | 1 | 1 |  |   | 1 |   |  |   |
| 991 902 | E | 1 |   |   |  |   |   |   |  |   |
| 991 946 | H | 2 | 2 |   |  |   | 1 |   |  |   |
| 991 998 | F | 1 |   |   |  |   | 1 |   |  |   |
| 992 663 | E | 1 |   | 1 |  |   |   |   |  |   |
| 992 689 | E | 1 |   | 1 |  |   |   |   |  |   |

L = lange Version      D = lange Version      En = long version      F = version longue      Pl = rozszerzona wersja      Cz = dlouhá verze      Es = versión larga  
S = kurze Version      S = kurze Version      S = short version      S = version courte      S = krótka wersja      S = krátká verze      S = versión corta

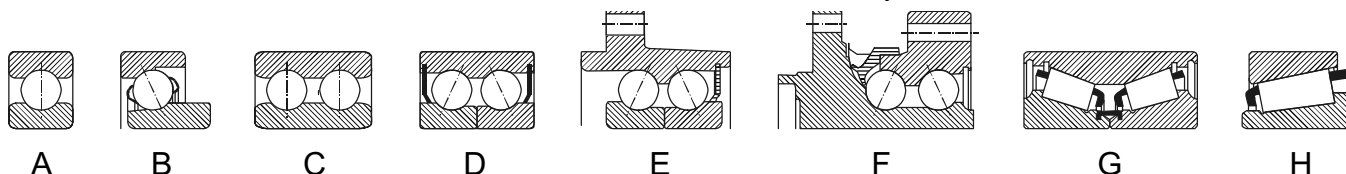





| OPTIMAL |   |   |   |   |  |   |  |  |  |  |  |
|---------|---|---|---|---|--|---|--|--|--|--|--|
| 992 754 | E | 1 |   | 1 |  |   |  |  |  |  |  |
| 992 894 | E | 1 |   |   |  |   |  |  |  |  |  |
| 992 922 | F | 1 |   |   |  |   |  |  |  |  |  |
| 992 943 | H | 2 | 1 |   |  | 1 |  |  |  |  |  |

L = lange Version      D = lange Version      En = long version      F = version longue      Pl = rozszerzona wersja      Cz = dlouhá verze      Es = versión larga  
 S = kurze Version      S = kurze Version      S = short version      S = version courte      S = krótka wersja      S = krátká verze      S = versión corta

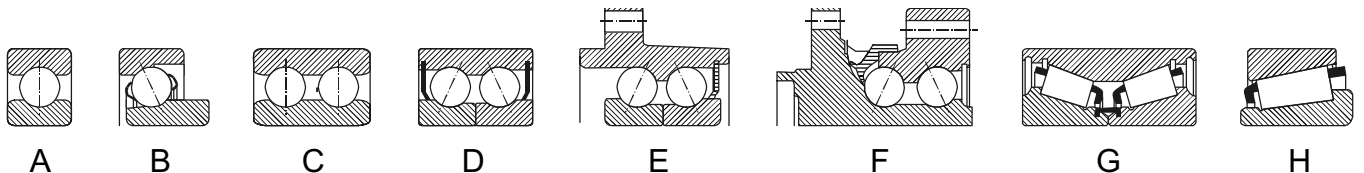

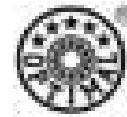

**VERGLEICHNUMMERNLISTE**

**CROSS REFERENCE GUIDE / LISTE DES ÉQUIVALENCES**

**ALFA ROMEO**

|            |  |         |
|------------|--|---------|
| 101369     |  | 801 588 |
| 60 51 0129 |  | 802 560 |
| 60 51 0366 |  | 801 500 |
| 60 53 7081 |  | 802 488 |
| 60 53 7081 |  | 802 646 |
| 60 55 4002 |  | 801 478 |
| 60 55 4002 |  | 802 540 |
| 60 55 4002 |  | 802 542 |
| 60 55 4002 |  | 802 556 |
| 60 55 4002 |  | 802 558 |
| 60 56 8138 |  | 802 335 |
| 60 61 3615 |  | 802 485 |
| 60 65 2014 |  | 802 870 |
| 60 65 2720 |  | 802 888 |
| 60 70 9431 |  | 801 588 |
| 60 75 1080 |  | 801 428 |
| 60 80 1380 |  | 801 428 |
| 60 80 8903 |  | 802 526 |
| 60 81 5903 |  | 801 972 |
| 60 81 6007 |  | 802 839 |
| 71 71 4478 |  | 801 970 |
| 82 39 0273 |  | 802 528 |
| 82 41 8685 |  | 802 562 |

**BMW**

|                 |  |         |
|-----------------|--|---------|
| 31 20 1 095 616 |  | 501 121 |
| 31 21 1 107 447 |  | 501 194 |
| 31 21 1 107 456 |  | 501 184 |
| 31 21 1 119 571 |  | 501 092 |
| 31 21 1 128 157 |  | 501 088 |
| 31 21 1 128 569 |  | 501 112 |
| 31 21 1 129 386 |  | 501 170 |
| 31 21 1 131 297 |  | 501 112 |
| 31 21 1 131 298 |  | 501 114 |
| 31 21 1 137 966 |  | 501 133 |
| 31 21 2 225 362 |  | 501 049 |
| 31 21 2 226 640 |  | 501 170 |
| 31 21 9 061 511 |  | 501 194 |
| 31 21 9 061 512 |  | 501 092 |
| 31 22 1 092 519 |  | 501 133 |
| 31 22 1 093 427 |  | 501 121 |
| 31 22 1 139 345 |  | 501 136 |
| 31 22 1 468 926 |  | 501 136 |
| 31 22 6 750 217 |  | 501 147 |
| 31 22 6 756 889 |  | 501 161 |
| 33 41 1 090 505 |  | 502 135 |
| 33 41 1 095 238 |  | 502 252 |

**BMW**

|                 |  |         |
|-----------------|--|---------|
| 33 41 1 095 652 |  | 502 123 |
| 33 41 1 107 512 |  | 502 178 |
| 33 41 1 108 408 |  | 502 134 |
| 33 41 1 119 138 |  | 502 178 |
| 33 41 1 120 038 |  | 502 158 |
| 33 41 1 123 415 |  | 502 066 |
| 33 41 1 123 426 |  | 502 070 |
| 33 41 1 124 358 |  | 502 068 |
| 33 41 1 124 358 |  | 502 125 |
| 33 41 1 124 358 |  | 502 138 |
| 33 41 1 130 617 |  | 502 072 |
| 33 41 1 130 617 |  | 502 109 |
| 33 41 1 130 617 |  | 502 148 |
| 33 41 1 133 124 |  | 502 070 |
| 33 41 6 756 830 |  | 502 163 |

**CHRYSLER**

|         |  |         |
|---------|--|---------|
| 4641196 |  | 991 898 |
| 5241067 |  | 991 998 |

**DAEWOO**

|            |  |         |
|------------|--|---------|
| 4142503203 |  | 971 290 |
| 4143103210 |  | 971 290 |
| 4143203210 |  | 971 290 |
| 90222850   |  | 971 391 |
| 90279332   |  | 971 391 |
| 90510629   |  | 972 397 |
| 90540069   |  | 972 397 |
| 926517101  |  | 972 389 |
| 926517201  |  | 972 389 |
| 926529001  |  | 972 389 |
| 926739001  |  | 971 393 |
| 926739005  |  | 971 393 |
| 938175001  |  | 971 393 |
| 96207566   |  | 971 940 |
| 96285525   |  | 971 917 |

**DAIHATSU**

|             |  |         |
|-------------|--|---------|
| 0211-27-305 |  | 901 445 |
| 0613-27-305 |  | 901 445 |
| 09265-35004 |  | 901 549 |
| 42410-87703 |  | 902 547 |
| 42410-87703 |  | 902 771 |
| 43246-87701 |  | 901 429 |
| 90043-11188 |  | 901 427 |
| 90043-11201 |  | 901 876 |
| 90043-11202 |  | 901 876 |
| 90043-63010 |  | 902 459 |
| 90043-63012 |  | 902 459 |

**DAIHATSU**

|             |  |         |
|-------------|--|---------|
| 90043-63012 |  | 902 999 |
| 90043-63013 |  | 902 457 |
| 90043-63079 |  | 902 457 |
| 90043-63087 |  | 901 427 |
| 90043-63087 |  | 901 461 |
| 90043-63100 |  | 902 443 |
| 90043-63150 |  | 901 429 |
| 90043-63188 |  | 901 425 |
| 90043-63252 |  | 901 231 |
| 90043-63253 |  | 901 231 |
| 90043-63256 |  | 902 999 |
| 90043-66039 |  | 902 855 |
| 90043-66044 |  | 901 549 |
| 90046-66023 |  | 901 895 |
| 90046-66023 |  | 901 896 |
| 97600-30203 |  | 901 890 |
| 97600-32005 |  | 901 890 |

**FIAT**











|            |  |         |
|------------|--|---------|
| 1300535080 |  | 681 325 |
| 26 20 4009 |  | 681 640 |
| 26 80 0140 |  | 801 644 |
| 26 80 0140 |  | 801 750 |
| 26 80 0330 |  | 801 644 |
| 26 80 0330 |  | 801 750 |
| 40 96 5870 |  | 801 746 |
| 43 30 647  |  | 681 504 |
| 43 30 647  |  | 681 506 |
| 43 39 3080 |  | 801 382 |
| 44 00 9180 |  | 801 342 |
| 44 00 9190 |  | 802 394 |
| 46 42 3870 |  | 801 364 |
| 46 43 9334 |  | 801 880 |
| 46 53 0316 |  | 802 605 |
| 46 55 4134 |  | 802 271 |
| 46 55 4135 |  | 802 980 |
| 46 77 3662 |  | 801 838 |
| 50 70 1247 |  | 802 265 |
| 58 90 9860 |  | 800 400 |
| 58 90 9870 |  | 800 398 |
| 58 90 9880 |  | 800 400 |
| 58 90 9890 |  | 801 360 |
| 58 90 9900 |  | 801 376 |
| 58 90 9910 |  | 801 450 |
| 58 90 9920 |  | 800 366 |
| 58 90 9940 |  | 801 342 |
| 58 91 1940 |  | 800 408 |

- Lager OEM / Bearing OEM / Roulement OEM

## VERGLEICHNUMMERNLISTE

### CROSS REFERENCE GUIDE / LISTE DES ÉQUIVALENCES

**FIAT**

|            |   |         |
|------------|---|---------|
| 59 41 7980 |   | 800 304 |
| 59 63 0340 |   | 802 444 |
| 60 51 0366 |    | 801 500 |
| 71 60 3600 |    | 802 740 |
| 71 62 1910 |    | 802 740 |
| 71 62 1910 |    | 802 748 |
| 71 71 4458 |   | 801 950 |
| 71 71 4459 |   | 801 836 |
| 71 71 4462 |   | 801 972 |
| 71 71 4463 |   | 802 839 |
| 71 71 4464 |   | 801 880 |
| 71 71 4471 |   | 802 839 |
| 71 71 4476 |   | 802 330 |
| 71 71 4477 |   | 802 330 |
| 71 72 9122 |   | 801 961 |
| 71 72 9123 |   | 802 233 |
| 71 72 9124 |   | 801 267 |
| 71 72 9125 |   | 801 974 |
| 71 73 1547 |   | 681 261 |
| 71 73 2444 |   | 681 259 |
| 71 74 4570 |   | 801 838 |
| 71 80 066  |   | 682 925 |
| 75 55 4660 |  | 801 360 |
| 75 55 4660 |  | 801 362 |
| 75 99 4610 |  | 802 318 |
| 75 99 4610 |  | 802 324 |
| 76 03 6790 |  | 802 330 |
| 76 13 5140 |   | 802 378 |
| 77 46 191  |   | 802 601 |
| 77 69 9020 |   | 802 315 |
| 82 37 4669 |  | 801 372 |
| 82 39 0273 |  | 801 730 |
| 82 40 3117 |   | 802 368 |
| 82 46 2175 |   | 802 526 |
| 82 46 9083 |   | 802 370 |
| 93 82 4579 |   | 681 923 |
| 9567217680 |   | 681 303 |
| 9567217780 |   | 682 305 |

**FORD**

|           |  |         |
|-----------|--|---------|
| 1 001 718 |  | 131 129 |
| 1 001 719 |  | 132 131 |
| 1 019 561 |  | 302 058 |
| 1 046 767 |  | 302 067 |
| 1 057 808 |  | 302 037 |
| 1 085 565 |  | 302 057 |
| 1 085 568 |  | 301 039 |













**FORD**

|           |  |         |
|-----------|--|---------|
| 1 085 569 |  | 301 045 |
| 1 088 380 |  | 301 132 |
| 1 115 019 |  | 302 197 |
| 1 133 023 |  | 301 183 |
| 1 146 689 |  | 302 197 |
| 1 225 764 |  | 301 511 |
| 4 052 783 |  | 301 185 |
| 4 164 670 |  | 302 257 |
| 4 164 671 |  | 302 255 |
| 5 007 026 |  | 301 280 |
| 5 007 027 |  | 300 052 |
| 5 007 028 |  | 300 004 |
| 5 007 029 |  | 300 062 |
| 5 007 030 |  | 301 151 |
| 5 007 033 |  | 302 146 |
| 5 007 034 |  | 302 254 |
| 5 007 035 |  | 302 160 |
| 5 007 036 |  | 302 172 |
| 5 007 037 |  | 301 230 |
| 5 007 038 |  | 301 232 |
| 5 007 039 |  | 301 018 |
| 5 007 040 |  | 301 006 |
| 5 007 041 |  | 302 162 |
| 5 007 114 |  | 302 234 |
| 5 008 557 |  | 300 004 |
| 5 008 715 |  | 302 046 |
| 5 008 716 |  | 301 034 |
| 5 010 762 |  | 301 038 |
| 5 011 391 |  | 302 076 |
| 5 011 392 |  | 302 074 |
| 5 012 346 |  | 301 244 |
| 5 012 347 |  | 302 120 |
| 5 012 470 |  | 302 208 |
| 5 012 477 |  | 301 246 |
| 5 012 478 |  | 302 122 |
| 5 013 161 |  | 301 130 |
| 5 015 586 |  | 302 174 |
| 5 015 587 |  | 302 176 |
| 5 015 650 |  | 302 124 |
| 5 019 971 |  | 302 240 |
| 5 020 654 |  | 302 058 |
| 5 020 655 |  | 302 058 |
| 5 020 656 |  | 301 180 |
| 5 024 195 |  | 301 180 |
| 5 024 196 |  | 301 132 |
| 5 024 251 |  | 302 248 |

**FORD**

|           |  |         |
|-----------|--|---------|
| 5 025 675 |  | 302 260 |
| 5 025 899 |  | 301 118 |
| 5 025 900 |  | 302 164 |
| 5 025 901 |  | 302 166 |
| 5 027 447 |  | 301 198 |
| 5 027 448 |  | 301 200 |
| 5 027 620 |  | 301 182 |
| 5 027 621 |  | 302 186 |
| 5 027 622 |  | 302 188 |
| 5 027 623 |  | 302 190 |
| 5 027 624 |  | 302 192 |
| 5 027 625 |  | 302 196 |
| 5 030 223 |  | 301 139 |
| 5 030 224 |  | 301 141 |
| 5 030 537 |  | 302 058 |
| 5 030 538 |  | 302 058 |

**HONDA**

|               |   |         |
|---------------|---|---------|
| 42200-S04-951 |   | 912 193 |
| 42200-S1A-E01 |   | 912 804 |
| 42200-S30-008 |   | 912 295 |
| 42200-S30-951 |   | 912 295 |
| 42200-S30-C11 |   | 912 295 |
| 42200-S30-J51 |   | 912 296 |
| 42200-SE0-004 |  | 912 532 |
| 42200-SM4-013 |  | 912 775 |
| 42200-SM4-A01 |  | 912 403 |
| 42200-SM4-J51 |  | 911 387 |
| 42200-SM4-J51 |  | 912 518 |
| 42200-SP0-951 |   | 912 992 |
| 42200-SP0-952 |   | 912 992 |
| 42200-SP0-953 |   | 912 992 |
| 42200-SR3-A4  |   | 912 990 |
| 42200-SR3-A53 |  | 912 423 |
| 42200-SS0-981 |  | 912 401 |
| 42200-SS0-981 |  | 912 803 |
| 42200-ST7-R51 |   | 912 294 |
| 42200-SV4-N51 |   | 912 292 |
| 42200-SX0-951 |   | 912 991 |
| 42200-SZ3-951 |   | 912 293 |
| 42300-S2L-004 |   | 912 809 |
| 42300-S2L-008 |   | 912 809 |
| 42300-SF1-008 |  | 912 545 |
| 44200-S04-005 |  | 912 530 |
| 44200-SB2-003 |  | 912 471 |
| 44200-SB2-015 |   | 912 530 |
| 44200-SM4-018 |  | 911 385 |

 Lager OEM / Bearing OEM / Roulement OEM

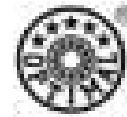

**VERGLEICHNUMMERNLISTE**

**CROSS REFERENCE GUIDE / LISTE DES ÉQUIVALENCES**

**HONDA**

|               |         |
|---------------|---------|
| 44200-SX0-008 | 911 968 |
| 44300-SB2-962 | 911 600 |
| 44300-SE0-004 | 881 704 |
| 44300-SF1-008 | 911 777 |
| 44300-SG0-008 | 911 399 |
| 44300-SP0-008 | 911 969 |
| 44300-SR3-004 | 911 377 |
| 44300-SR3-A02 | 911 383 |
| 8-94227-041   | 201 262 |
| 8-94258-819   | 201 262 |
| 91051-689-003 | 911 621 |
| 91051-689-003 | 911 623 |
| 91051-689-003 | 911 625 |
| 91051-689-003 | 911 629 |
| 91051-692-003 | 911 513 |
| 91051-SA7-013 | 911 782 |
| 91051-SB0-010 | 911 375 |
| 91252-692-931 | 912 473 |

**HYUNDAI**

|             |         |
|-------------|---------|
| 51720-29150 | 951 962 |
| 51720-2D000 | 921 906 |
| 51720-34200 | 951 282 |
| 51720-3A101 | 921 895 |
| 52710-25100 | 922 189 |
| 52710-25101 | 922 189 |
| 52710-25450 | 922 783 |
| 52710-26500 | 922 877 |
| 52710-29150 | 922 979 |
| 52710-29400 | 922 781 |
| 52710-29450 | 922 979 |
| 52710-29461 | 922 921 |
| 52710-29470 | 922 979 |
| 52710-29471 | 922 979 |
| 52710-3A000 | 922 875 |
| 52713-21100 | 922 187 |

**ISUZU**

|               |         |
|---------------|---------|
| 8-94248-077   | 931 930 |
| 8-94429-847   | 932 864 |
| 9-00032-209   | 932 933 |
| 9-00093-081   | 932 665 |
| 9-00093-082   | 932 665 |
| 9-00093-149   | 931 649 |
| 9-00093-172   | 931 649 |
| 9-00093-173   | 931 930 |
| 9-00094-627-2 | 932 794 |

**JAGUAR**

|         |         |
|---------|---------|
| JLM 258 | 880 493 |
|---------|---------|

**KIA**

|              |         |
|--------------|---------|
| 0K9A2-26-150 | 922 179 |
| 0K9A4-26-150 | 922 181 |
| 0S083-33075  | 941 281 |
| OK202-26150  | 922 787 |
| OK216-26150  | 922 789 |

**LADA**

|               |         |
|---------------|---------|
| 21012403080   | 802 454 |
| 21083103020   | 801 442 |
| 21083104020   | 802 658 |
| 21212403080   | 802 590 |
| 2121310302010 | 801 656 |

**LANCIA**

|            |         |
|------------|---------|
| 46 42 6612 | 802 331 |
| 71 71 4459 | 801 836 |
| 71 71 4471 | 802 839 |
| 82 37 4669 | 802 620 |

**MAZDA**









|              |         |
|--------------|---------|
| 0259-33-047  | 941 497 |
| 0259-33-047  | 941 563 |
| 1011-26-151  | 942 501 |
| 1391-33-047  | 942 818 |
| 1391-33-047  | 942 820 |
| 1391-33-075  | 941 617 |
| 1391-33-075  | 941 647 |
| 1391-33-075  | 941 689 |
| 4122-26-151  | 942 619 |
| 8531-33-075  | 941 497 |
| 8545-33-047  | 941 647 |
| 8871-26-151A | 942 788 |
| 9960-30-204  | 941 511 |
| 9960-30-206  | 941 511 |
| 9960-30-208  | 942 693 |
| 9960-30-208  | 942 695 |
| 9960-30-208  | 942 754 |
| 9960-32-011  | 942 651 |
| B001-33-047  | 940 632 |
| B001-33-047  | 941 617 |
| B001-33-047  | 941 634 |
| B001-33-047  | 941 636 |
| B001-33-047  | 941 874 |
| B002-33-047  | 942 566 |
| B002-33-047  | 942 674 |
| B002-33-047  | 942 768 |

**MAZDA**













|              |         |
|--------------|---------|
| B002-33-047  | 942 770 |
| B002-33-075  | 941 873 |
| B002-33-075  | 942 674 |
| B002-33-075  | 942 768 |
| B002-33-075  | 942 770 |
| B092-26-075  | 941 786 |
| B092-26-075  | 942 566 |
| B092-26-075  | 942 568 |
| B092-26-075  | 942 570 |
| B092-26-075  | 942 818 |
| B092-26-075  | 942 820 |
| B092-26-175  | 942 568 |
| B092-26-175  | 942 570 |
| B092-33-067  | 941 636 |
| B216-26-17X  | 941 689 |
| B260-33-048  | 941 700 |
| B455-26-15XA | 942 569 |
| B455-33-047B | 941 700 |
| B455-33-047C | 941 840 |
| B603-26-15XB | 942 773 |
| D102-26-15X  | 942 177 |
| D201-26-15X  | 942 177 |
| FB01-26-151A | 940 371 |
| FB01-26-151A | 942 671 |
| FB05-49-060  | 941 673 |
| G14V-26-15X  | 942 273 |
| G14V-26-15XA | 942 273 |
| G14V-26-15XB | 942 273 |
| G238-26-151  | 942 987 |
| G401-17-190  | 941 786 |
| G401-17-190  | 941 873 |
| G717-26-139  | 942 987 |
| G717-26-154  | 942 987 |
| GA5R-26-15X  | 941 862 |
| GE4V-26-15X  | 942 381 |
| GE4V-26-15XA | 942 291 |
| GJ21-26-151  | 942 672 |
| GJ21-33-042B | 942 672 |
| GJ21-33-042B | 942 987 |
| H001-26-151  | 941 734 |
| H001-26-151  | 942 738 |
| H260-33-047  | 941 784 |
| H266-26-151  | 941 602 |
| H266-26-151  | 942 736 |
| J001-26-139  | 942 988 |
| J001-26-151  | 942 988 |

- Lager OEM / Bearing OEM / Roulement OEM







**VERGLEICHNUMMERNLISTE**
**CROSS REFERENCE GUIDE / LISTE DES ÉQUIVALENCES**
**MAZDA**

|              |   |
|--------------|---|
| LA01-33-042B | 942 273   |
| LA01-33-04XB | 941 967   |
| LB40-26-151  |  942 989 |
| LB83-33-060  | 941 967   |
| NA01-33-04X  | 941 842   |
| NA01-33-04XA |  941 951 |
| S083-33-047  |  941 565 |
| S083-33-047  |  941 687 |
| S083-33-047  |  941 691 |
| S083-33-075  |  941 565 |
| S083-33-075  |  941 691 |
| S121-33-075A |  941 687 |

























**MERCEDES**

|               |   |
|---------------|---|
| 000 187 00 22 | 401 300   |
| 000 207 20 09 | 402 301   |
| 000 980 42 02 |  401 100   |
| 000 980 42 02 |  401 104   |
| 000 980 82 02 |  401 100   |
| 000 980 82 02 |  401 104 |
| 000 980 82 02 |  402 143 |
| 001 981 57 05 |  402 216 |
| 001 981 61 05 |  402 143 |
| 001 981 89 05 |  402 119 |
| 002 981 13 05 |  402 119 |
| 003 981 10 05 |  401 137 |
| 007 981 04 05 |  401 212 |
| 009 981 41 05 |  401 212 |
| 111 330 00 51 | 401 276   |
| 111 586 04 33 | 401 276   |
| 115 330 00 51 | 401 222   |
| 115 586 02 35 | 402 030   |
| 115 586 03 33 | 401 222   |
| 115 586 08 35 | 402 030   |
| 115 586 11 35 | 402 030   |
| 116 330 00 51 | 401 028   |
| 116 586 00 33 | 401 028   |
| 123 350 00 68 | 402 030   |
| 123 586 00 35 | 402 030   |
| 124 330 00 51 | 401 096   |
| 124 330 01 51 | 401 096   |
| 124 350 05 49 | 402 080   |
| 124 350 06 49 | 402 080   |
| 124 350 07 49 | 402 116   |
| 124 980 04 16 | 402 080   |
| 124 980 05 16 | 402 080   |
| 126 330 00 51 | 401 126   |

**MERCEDES**

|               |   |
|---------------|---|
| 129 330 00 51 | 401 078   |
| 129 350 00 49 | 402 116   |
| 129 980 00 16 | 402 116   |
| 129 980 01 16 | 402 116   |
| 129 980 02 16 | 402 116   |
| 129 980 03 16 | 402 116   |
| 129 980 04 16 | 402 116   |
| 140 330 00 51 | 401 082   |
| 140 330 02 51 | 401 082   |
| 140 350 00 49 | 402 242   |
| 140 350 01 49 | 402 242   |
| 140 980 01 16 |  402 081   |
| 140 980 04 16 | 402 242   |
| 140 980 05 16 | 402 242   |
| 140 980 06 16 | 402 243   |
| 140 980 07 16 | 402 242   |
| 163 330 00 51 | 400 051   |
| 168 981 03 27 |  402 063   |
| 168 981 06 27 |  401 047 |
| 169 981 00 27 | 402 827   |
| 201 330 00 51 | 401 277   |
| 201 330 01 51 | 401 048   |
| 201 330 02 51 | 401 042   |
| 201 350 01 49 | 402 116   |
| 201 350 02 49 | 402 116   |
| 201 350 05 49 | 402 116   |
| 201 980 00 16 | 402 116   |
| 202 330 00 51 | 401 078   |
| 202 980 00 16 | 402 116   |
| 202 980 01 16 | 402 116   |
| 202 981 01 27 |  400 107 |
| 203 330 00 51 | 401 157   |
| 203 980 00 16 | 402 159   |
| 210 330 00 51 | 401 078   |
| 210 330 01 51 | 400 061   |
| 210 980 01 16 | 402 243   |
| 211 981 02 27 | 402 505   |
| 220 330 07 25 | 401 083   |
| 230 330 03 25 | 401 501   |
| 601 350 04 68 | 402 050   |
| 601 350 15 10 | 402 050   |
| 608 981 00 05 |  401 137 |
| 611 330 08 25 | 401 137   |
| 631 330 00 51 | 401 214   |
| 631 330 02 51 | 401 214   |
| 631 981 00 05 |  402 216 |

**MITSUBISHI**

|          |   |
|----------|---|
| MA125842 |  920 752   |
| MA125843 |  920 752   |
| MA125945 |  952 832   |
| MA125987 | 952 996   |
| MA151215 | 952 996   |
| MA181498 | 952 996   |
| MB001315 |  952 758   |
| MB001315 |  952 935   |
| MB002072 |  951 756   |
| MB002073 |  951 756   |
| MB005395 |  952 809   |
| MB005396 |  952 809   |
| MB025004 |  951 659   |
| MB025005 |  951 659   |
| MB025006 |  951 657   |
| MB092177 |  952 679   |
| MB092179 | 952 993   |
| MB092185 |  952 679   |
| MB092432 |  952 661 |
| MB092440 | 952 297   |
| MB092749 |  951 722 |
| MB109051 |  951 519 |
| MB109564 |  951 708 |
| MB109565 |  951 708 |
| MB161132 |  952 577 |
| MB290157 | 952 993   |
| MB290426 | 952 993   |
| MB290428 | 952 993   |
| MB296739 | 951 284   |
| MB303865 |  951 449 |
| MB303865 |  951 604 |
| MB349416 |  951 606 |
| MB393210 |  952 593 |
| MB393803 | 952 993   |
| MB393807 | 952 993   |
| MB515470 |  952 678 |
| MB515471 |  952 676 |
| MB569972 | 952 993   |
| MB569972 | 952 993   |
| MB584326 |  952 608 |
| MB584761 |  952 710 |
| MB584790 |  952 415 |
| MB584790 | 952 994   |
| MB633429 | 951 971   |
| MB633430 | 951 971   |
| MB633432 | 951 971   |

 - Lager OEM / Bearing OEM / Roulement OEM

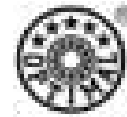

**VERGLEICHNUMMERNLISTE**

**CROSS REFERENCE GUIDE / LISTE DES ÉQUIVALENCES**

**MITSUBISHI**

|          |  |         |
|----------|--|---------|
| MB633434 |  | 951 971 |
| MB633435 |  | 951 971 |
| MB663557 |  | 952 417 |
| MB663630 |  | 952 551 |
| MB663664 |  | 952 995 |
| MB664447 |  | 952 936 |
| MB664611 |  | 952 297 |
| MB664611 |  | 952 769 |
| MB664612 |  | 952 297 |
| MB808442 |  | 951 409 |
| MB837719 |  | 952 297 |
| MB844220 |  | 952 279 |
| MB844919 |  | 952 405 |
| MB864847 |  | 991 902 |
| MB864929 |  | 992 894 |
| MB886298 |  | 952 996 |
| MB886601 |  | 952 996 |
| MR103654 |  | 952 997 |
| MR111877 |  | 952 297 |
| MT191613 |  | 952 993 |
| MT202119 |  | 951 657 |
| MT321624 |  | 952 577 |

**NISSAN**

|             |  |         |
|-------------|--|---------|
| 01014-10514 |  | 961 675 |
| 40200-0V010 |  | 961 964 |
| 40210-01E00 |  | 960 702 |
| 40210-01E00 |  | 961 576 |
| 40210-05U00 |  | 961 701 |
| 40210-2Y000 |  | 961 900 |
| 40210-30R01 |  | 960 638 |
| 40210-33P07 |  | 961 753 |
| 40210-34B00 |  | 961 610 |
| 40210-41B00 |  | 961 479 |
| 40210-4M400 |  | 961 229 |
| 40210-50A00 |  | 960 578 |
| 40210-50W00 |  | 961 801 |
| 40210-61501 |  | 962 603 |
| 40210-85000 |  | 962 435 |
| 40210-85000 |  | 962 686 |
| 40210-A0100 |  | 961 724 |
| 40210-A0100 |  | 961 765 |
| 40210-A0100 |  | 961 792 |
| 40210-A0100 |  | 961 903 |
| 40210-A0800 |  | 962 682 |
| 40210-C6000 |  | 961 904 |
| 40210-C6000 |  | 961 965 |

**NISSAN**

|             |  |         |
|-------------|--|---------|
| 40210-F1700 |  | 961 677 |
| 40210-F1700 |  | 961 808 |
| 40210-F6600 |  | 961 759 |
| 40215-A0100 |  | 961 724 |
| 40215-A0100 |  | 961 765 |
| 40215-A0100 |  | 961 792 |
| 40215-A0100 |  | 961 903 |
| 40215-A0100 |  | 962 682 |
| 40215-A0100 |  | 962 760 |
| 40215-A0100 |  | 962 776 |
| 40215-C6000 |  | 961 411 |
| 40215-C6000 |  | 961 904 |
| 40215-D0100 |  | 961 801 |
| 40215-D0100 |  | 961 883 |
| 40215-F1700 |  | 961 677 |
| 40215-F1700 |  | 961 808 |
| 40215-M0205 |  | 961 796 |
| 40215-M5600 |  | 961 680 |
| 40227-C8200 |  | 961 965 |
| 40232-01J00 |  | 961 965 |
| 43085-42G00 |  | 962 985 |
| 43200-0M801 |  | 962 241 |
| 43200-21B00 |  | 962 481 |
| 43200-2F500 |  | 962 986 |
| 43200-2Y000 |  | 962 903 |
| 43200-30R06 |  | 962 853 |
| 43200-48B11 |  | 962 481 |
| 43200-50J05 |  | 962 703 |
| 43200-50J15 |  | 962 705 |
| 43200-50Y10 |  | 962 712 |
| 43200-50Y12 |  | 962 714 |
| 43200-5F617 |  | 962 481 |
| 43200-70N05 |  | 962 981 |
| 43200-9F510 |  | 962 986 |
| 43200-AV700 |  | 962 873 |
| 43202-34B00 |  | 962 548 |
| 43202-CA000 |  | 962 823 |
| 43210-01J10 |  | 962 413 |
| 43210-0C700 |  | 962 984 |
| 43210-21000 |  | 962 286 |
| 43210-21000 |  | 962 767 |
| 43210-35F01 |  | 961 751 |
| 43210-42G10 |  | 962 985 |
| 43210-50A00 |  | 962 716 |
| 43210-50A00 |  | 962 718 |
| 43210-76000 |  | 962 605 |

**NISSAN**





|              |  |         |
|--------------|--|---------|
| 43210-AG000  |  | 962 897 |
| 43210-C9300  |  | 961 411 |
| 43210-C9300  |  | 961 965 |
| 43210-C9300  |  | 962 913 |
| 43210-D0100  |  | 962 760 |
| 43210-M7000  |  | 962 776 |
| 43210-T6200  |  | 962 847 |
| 43215-21P05  |  | 962 767 |
| 43215-76000  |  | 962 605 |
| 43215-F6100  |  | 962 286 |
| 43215-G8100  |  | 962 949 |
| 43215-H5000  |  | 962 684 |
| 43215-T3200  |  | 962 841 |
| 43215-T3200  |  | 962 899 |
| 43215-T3200  |  | 962 905 |
| 43232-9C500  |  | 962 985 |
| 43232-F6100  |  | 962 286 |
| 43252-0F000  |  | 962 985 |
| 432834-40P05 |  | 962 755 |
| 432834-40P05 |  | 962 757 |
| 90369-38003  |  | 961 648 |

**OPEL**





|           |  |         |
|-----------|--|---------|
| 03 26 180 |  | 201 084 |
| 16 03 065 |  | 200 012 |
| 16 03 109 |  | 200 020 |
| 16 03 143 |  | 201 517 |
| 16 03 191 |  | 201 032 |
| 16 03 192 |  | 201 040 |
| 16 03 193 |  | 200 012 |
| 16 03 193 |  | 202 065 |
| 16 03 194 |  | 201 084 |
| 16 03 195 |  | 201 210 |
| 16 03 196 |  | 201 228 |
| 16 03 208 |  | 201 033 |
| 16 03 209 |  | 201 035 |
| 16 03 210 |  | 201 031 |
| 16 03 211 |  | 201 043 |
| 16 03 253 |  | 201 621 |
| 16 03 254 |  | 201 623 |
| 16 04 002 |  | 202 218 |
| 16 04 003 |  | 202 142 |
| 16 04 004 |  | 202 140 |
| 16 04 005 |  | 202 059 |
| 16 04 007 |  | 202 021 |
| 16 04 198 |  | 202 252 |
| 16 04 209 |  | 202 252 |

- Lager OEM / Bearing OEM / Roulement OEM

**VERGLEICHSNUMMERNLISTE**
**CROSS REFERENCE GUIDE / LISTE DES ÉQUIVALENCES**
**OPEL**

|            |   |
|------------|---|
| 16 04 210  | 202 236   |
| 16 04 212  | 202 202   |
| 16 04 213  | 202 204   |
| 16 04 213  | 202 236   |
| 16 04 285  | 202 226   |
| 16 04 286  | 200 020   |
| 16 04 287  | 202 026   |
| 16 04 288  | 202 252   |
| 16 04 289  | 202 236   |
| 16 04 290  | 202 202   |
| 16 04 291  | 202 204   |
| 16 04 292  | 202 168   |
| 16 04 301  | 202 218   |
| 16 04 302  | 202 142   |
| 16 04 303  | 202 140   |
| 16 04 306  | 202 142   |
| 16 04 307  | 202 140   |
| 16 04 314  | 202 519   |
| 16 04 315  | 202 625   |
| 16 04 316  | 202 627   |
| 3 28 980   | 201 095   |
| 3 30 019   |  201 262 |
| 3 30 020   |  201 262 |
| 4 14 300   |  202 153 |
| 4 14 301   |  202 155 |
| 42 02 40   | 202 023   |
| 44 03 023  | 701 860   |
| 44 03 943  | 702 436   |
| 44 08 277  | 202 101   |
| 44 08 668  | 201 089   |
| 44 08 669  | 201 085   |
| 90 005 147 | 200 012   |
| 90 005 218 | 202 252   |
| 90 016 721 | 200 020   |
| 90 019 085 | 202 252   |
| 90 019 086 | 202 236   |
| 90 019 333 | 202 202   |
| 90 019 334 | 202 204   |
| 90 235 571 |  201 084 |
| 90 448 664 | 202 236   |
| 90 448 665 | 202 202   |
| 90 473 997 | 202 218   |
| 90 486 457 | 200 020   |
| 90 486 458 | 201 040   |
| 90 486 459 | 202 226   |
| 90 486 460 | 201 032   |





**OPEL**

|            |   |
|------------|---|
| 90 486 461 | 202 026   |
| 90 486 462 | 202 252   |
| 90 486 463 | 200 012   |
| 90 486 464 | 202 236   |
| 90 486 465 | 202 202   |
| 90 486 466 | 202 204   |
| 90 486 467 | 201 084   |
| 90 486 468 | 202 168   |
| 90 510 542 | 201 228   |
| 90 510 543 | 202 218   |
| 90 510 544 | 201 210   |
| 90 510 629 | 202 142   |
| 90 511 494 | 202 140   |
| 90 540 069 | 202 142   |
| 90 540 262 | 202 140   |
| 91 143 341 |  202 153   |
| 91 149 606 |  202 155   |
| 91 159 917 | 202 101   |
| 91 160 086 | 201 089   |
| 91 17 760  | 202 059   |
| 91 20 128  | 202 142   |
| 91 20 129  | 202 140   |
| 91 95 608  | 201 095   |
| 91 96 286  | 202 021   |
| 91 96 298  | 202 023   |
| 91160087   | 201 085   |
| 93 170 611 | 202 519   |
| 93 178 625 | 202 625   |
| 93 178 626 | 202 627   |
| 93 178 651 | 201 621   |
| 93 178 652 | 201 623   |
| 94 227 041 |  201 262 |
| 94 258 819 |  201 262 |





**PORSCHE**

|             |         |
|-------------|---------|
| 99905302000 | 102 103 |
|-------------|---------|

**PSA**

|         |   |
|---------|---|
| 3307.56 | 600 308   |
| 3307.58 | 602 344   |
| 3307.61 | 602 937   |
| 3326.09 |  602 539 |
| 3326.09 |  602 821 |
| 3326.10 |  602 412 |
| 3326.14 |  601 580 |
| 3326.28 |  602 430 |
| 3350.02 | 602 406   |
| 3350.06 | 601 654   |

**PSA**



|         |   |
|---------|---|
| 3350.07 | 601 495   |
| 3350.11 | 601 396   |
| 3350.12 | 602 390   |
| 3350.15 |  601 348   |
| 3350.16 | 600 308   |
| 3350.17 | 601 306   |
| 3350.18 | 600 334   |
| 3350.19 | 602 322   |
| 3350.19 |  602 926   |
| 3350.20 | 601 336   |
| 3350.21 | 681 506   |
| 3350.22 | 682 508   |
| 3350.22 | 682 510   |
| 3350.23 | 682 490   |
| 3350.23 | 682 492   |
| 3350.24 | 681 325   |
| 3350.25 | 682 327   |
| 3350.26 | 682 329   |
| 3350.27 | 681 303   |
| 3350.28 | 682 305   |
| 3350.29 | 681 506   |
| 3350.30 | 681 325   |
| 3350.31 | 601 323   |
| 3350.32 |  601 916 |
| 3350.33 | 600 308   |
| 3350.69 | 601 953   |
| 3350.70 | 681 261   |
| 3350.71 | 682 263   |
| 3350.72 | 601 253   |
| 3350.81 | 681 261   |
| 3350.82 | 601 675   |
| 3701.42 | 602 340   |
| 3701.52 | 602 338   |
| 3701.54 | 602 388   |
| 3701.58 | 602 343   |
| 3701.59 | 602 314   |
| 3701.67 | 602 347   |
| 3701.68 | 602 349   |
| 3701.74 | 602 349   |
| 3730.21 |  602 858 |
| 3748.04 | 602 541   |
| 3748.05 | 602 541   |
| 3748.08 | 602 815   |
| 3748.09 | 601 384   |
| 3748.10 | 602 414   |
| 3748.11 | 602 859   |

 - Lager OEM / Bearing OEM / Roulement OEM

**VERGLEICHNUMMERNLISTE**

**CROSS REFERENCE GUIDE / LISTE DES ÉQUIVALENCES**





















**PSA**

|               |   |
|---------------|---|
| 3748.13       | 602 414   |
| 3748.14       | 602 859   |
| 3748.15       | 602 340   |
| 3748.17       | 602 320   |
| 3748.28       | 602 337   |
| 3748.29       | 602 339   |
| 3748.30       |  602 356   |
| 3748.31       | 602 361   |
| 3748.32       | 602 314   |
| 3748.33       | 602 344   |
| 3748.33       | 602 937   |
| 3748.34       | 602 369   |
| 3748.35       | 602 367   |
| 3748.36       | 602 345   |
| 3748.37       | 602 645   |
| 3748.38       | 602 386   |
| 3748.41       | 602 249   |
| 3748.42       | 602 322   |
| 3748.69       | 602 927   |
| 3748.70       | 602 955   |
| 3748.74       | 602 956   |
| 3748.76       | 602 251   |
| 3748.77       | 602 669   |
| 3748.82       | 602 681   |
| 3748.85       | 602 835   |
| 3748.85       | 601 834   |
| 3748.86       | 602 681   |
| 54 28 352     |  602 358 |
| 54 51 859     | 601 440   |
| 54 51 860     | 602 865   |
| 55 02 233     | 602 815   |
| 75 523 458    | 602 418   |
| 79 01 335 011 | 601 396   |
| 79 03 090 194 |  602 512 |
| 95 496 146    | 602 340   |
| 95 548 417    | 601 434   |
| 95 554 319    | 601 828   |
| 95 555 853    | 681 640   |
| 95 557 561    | 682 642   |
| 95 562 212    | 602 414   |
| 95 577 213    | 601 502   |
| 95 616 709    | 601 828   |
| 95 619 158    | 602 416   |
| 95 619 160    | 600 308   |
| 95 619 161    | 601 336   |
| 95 619 162    | 602 340   |

**PSA**

|            |   |
|------------|---|
| 95 619 163 | 602 358   |
| 95 619 164 | 602 392   |
| 95 619 166 | 601 434   |
| 95 619 170 | 681 504   |
| 95 619 171 | 682 420   |
| 95 619 171 | 682 422   |
| 95 637 150 |  602 356 |
| 95 654 074 | 600 334   |
| 95 654 076 | 601 306   |
| 95 654 077 | 602 322   |
| 95 654 078 | 602 320   |
| 95 666 965 | 602 341   |
| 95 669 382 | 682 329   |

**RENAULT**

|               |   |
|---------------|---|
| 50 00 389 906 |  702 448   |
| 50 00 390 129 |  701 726   |
| 50 00 390 129 |  701 728   |
| 60 25 102 558 | 702 365   |
| 60 25 102 710 | 702 363   |
| 60 25 170 050 | 702 363   |
| 60 25 171 136 | 702 537   |
| 60 25 171 137 | 702 365   |
| 60 25 370 612 | 702 866   |
| 70 01 205 170 | 702 321   |
| 77 00 780 919 |  702 514 |
| 77 00 780 921 |  702 494 |
| 77 00 787 639 |  702 380 |
| 77 00 787 640 |  702 552 |
| 77 00 787 641 |  702 313 |
| 77 00 803 923 |  702 311 |
| 77 00 803 924 |  702 313 |
| 77 00 803 928 |  702 380 |
| 77 00 803 929 |  702 311 |
| 77 00 803 929 |  702 452 |
| 77 00 803 931 |  702 550 |
| 77 00 814 192 | 702 765   |
| 77 00 820 849 |  702 357 |
| 77 00 820 850 |  702 355 |
| 77 00 829 031 |  702 321 |
| 77 00 840 609 |  702 353 |
| 77 00 845 104 |  702 351 |
| 77 00 845 195 |  702 915 |
| 77 01 204 665 | 702 380   |
| 77 01 204 666 |  702 494 |
| 77 01 204 667 | 702 309   |
| 77 01 204 689 | 702 357   |





**RENAULT**

|               |   |
|---------------|---|
| 77 01 204 690 | 702 355   |
| 77 01 204 692 | 702 311   |
| 77 01 204 693 | 702 313   |
| 77 01 204 695 | 702 552   |
| 77 01 204 696 |  702 514 |
| 77 01 204 867 | 702 351   |
| 77 01 204 868 | 702 359   |
| 77 01 205 416 | 701 860   |
| 77 01 205 417 | 702 846   |
| 77 01 205 471 | 702 958   |
| 77 01 205 472 | 702 960   |
| 77 01 205 477 | 702 351   |
| 77 01 205 499 | 702 850   |
| 77 01 205 596 | 702 426   |
| 77 01 205 692 | 701 404   |
| 77 01 205 778 | 701 302   |
| 77 01 205 778 | 701 319   |
| 77 01 205 779 | 700 310   |
| 77 01 205 780 | 701 307   |
| 77 01 205 812 | 702 312   |
| 77 01 205 972 | 701 914   |
| 77 01 206 353 | 702 957   |
| 77 01 206 354 | 702 959   |
| 77 01 206 661 | 701 975   |
| 77 01 206 740 | 701 860   |
| 77 01 206 742 | 702 846   |
| 77 01 206 771 | 700 245   |
| 77 01 206 847 | 201 089   |
| 77 01 206 848 | 201 085   |
| 77 01 206 849 | 202 101   |
| 77 01 207 358 | 701 247   |
| 77 01 207 676 | 701 978   |
| 77 01 207 677 | 701 977   |
| 77 01 208 058 | 702 982   |
| 77 01 208 059 | 702 983   |
| 77 01 460 637 | 701 374   |
| 77 01 460 638 | 701 826   |
| 77 01 460 639 | 701 332   |
| 77 01 460 641 | 702 350   |
| 77 01 460 641 | 702 817   |
| 77 01 460 642 | 702 328   |
| 77 01 461 730 | 702 456   |
| 77 01 462 019 | 701 432   |
| 77 01 462 020 | 701 326   |
| 77 01 462 021 | 701 404   |
| 77 01 462 469 | 701 302   |

 - Lager OEM / Bearing OEM / Roulement OEM



**VERGLEICHSNUMMERNLISTE**
**CROSS REFERENCE GUIDE / LISTE DES ÉQUIVALENCES**
**RENAULT**

|               |   |
|---------------|---|
| 77 01 462 469 | 701 319   |
| 77 01 463 231 | 701 326   |
| 77 01 463 523 | 702 352   |
| 77 01 463 940 | 702 692   |
| 77 01 463 986 | 702 316   |
| 77 01 463 987 | 701 307   |
| 77 01 464 049 | 700 310   |
| 77 01 464 049 | 701 346   |
| 77 01 465 181 | 701 302   |
| 77 01 465 181 | 701 319   |
| 77 01 465 646 | 702 586   |
| 77 01 465 647 | 702 436   |
| 77 01 465 735 | 702 312   |
| 77 01 467 803 | 701 307   |
| 77 01 467 860 | 701 307   |
| 77 01 469 682 | 701 852   |
| 77 01 470 552 | 701 914   |
| 77 01 803 928 |  702 309   |
| 77 03 090 199 |  701 424 |
| 77 03 090 222 |  701 326 |
| 77 03 090 264 |  702 462 |
| 77 03 090 353 | 700 310   |
| 77 04 002 263 | 702 380   |
| 77 04 002 264 | 702 552   |







**ROVER**

|             |         |
|-------------|---------|
| ANR 5861    | 880 912 |
| CKP 7058EVA | 882 729 |
| GHK 1285    | 881 609 |
| GHK 1286    | 882 613 |
| GHK 1287    | 882 611 |
| GHK 1366    | 881 594 |
| GHK 1549    | 882 463 |
| GHK 1550    | 882 463 |
| GHK 1551    | 882 729 |
| GHK 1559    | 881 725 |
| GHK 1560    | 882 487 |
| GHK 1561    | 882 483 |
| GHK 1564    | 882 607 |
| GHK 1569    | 882 626 |
| GHK 1570    | 882 624 |
| GHK 1596    | 882 487 |
| GHK 1597    | 882 483 |
| GHK 1631    | 882 167 |
| GHK 1685    | 882 896 |
| GHK 1692    | 881 237 |
| GHK 1693    | 882 235 |

**ROVER**

|               |         |
|---------------|---------|
| GHK 1933      | 881 704 |
| RFM 001484EVA | 882 727 |





**SAAB**

|            |   |
|------------|---|
| 46 89 923  |  891 630 |
| 46 89 923  |  891 887 |
| 89 22 205  | 891 509   |
| 89 47 384  | 892 670   |
| 89 47 384  | 892 806   |
| 89 52 5822 | 892 476   |
| 89 52 996  | 891 546   |
| 89 63 084  |  892 668 |
| 89 71 103  | 891 496   |
| 89 73 406  |  892 498 |
| 91 04 209  |  891 524 |
| 91 04 209  |  891 706 |

**SEAT**

|                 |   |
|-----------------|---|
| 39 81 586       | 801 342   |
| 39 81 588       | 801 354   |
| 39 81 589       | 801 354   |
| 39 81 590       | 800 408   |
| 39 81 591       | 801 574   |
| 39 81 592       | 801 698   |
| 39 81 593       | 802 394   |
| 39 81 594       | 802 318   |
| 39 81 595       | 802 480   |
| SE 021 140 301A | 801 354   |
| SE 021 140 301B | 801 354   |
| SE 025 140 301A | 800 408   |
| XO 44 00 918    |  801 342 |

**SKODA**

|             |   |
|-------------|---|
| 961 230 600 |  802 720 |
| 963 030 400 |  801 618 |
| 969 106 801 |  801 543 |
| 969 106 801 |  801 694 |
| 969 300 304 |  801 618 |













**SUBARU**

|             |   |
|-------------|---|
| 28015-AA090 | 972 709   |
| 28015-TA000 | 971 285   |
| 28016-AA011 |  971 707 |
| 28016-TA000 | 971 285   |
| 6210-14110  | 972 465   |
| 6210-14111  | 972 465   |
| 6999-00081  | 972 637   |
| 6999-00120  | 972 633   |
| 6999-00900  | 972 639   |

**SUBARU**

|             |   |
|-------------|---|
| 6999-01010  | 971 615   |
| 7230-34040  | 971 641   |
| 7230-34050  | 971 641   |
| 7230-38070  | 971 641   |
| 7999-23040  | 971 627   |
| 7999-23110  | 971 635   |
| 7999-23130  | 971 641   |
| 90610-0007  |  972 465 |
| X9061-GA000 | 971 631   |

**SUZUKI**

|             |   |
|-------------|---|
| 08123-62047 | 972 721   |
| 08314-41163 | 972 453   |
| 08314-41168 | 972 453   |
| 08322-11167 | 972 453   |
| 08322-11168 | 972 453   |
| 09180-21001 | 972 453   |
| 09180-21001 | 972 721   |
| 09180-35005 | 971 455   |
| 09262-20069 | 972 453   |
| 09262-25061 | 972 453   |
| 09262-25061 | 972 721   |
| 09262-30030 | 972 275   |
| 09262-30030 |  972 699 |
| 09262-35009 |  972 571 |
| 09262-35012 | 971 455   |
| 09262-35032 | 971 455   |
| 09265-41001 |  971 451 |
| 09267-28002 |  971 567 |
| 09267-35003 |  972 715 |
| 09267-36001 |  971 575 |
| 09267-36002 |  971 711 |
| 09267-40001 |  971 723 |
| 09269-35009 |  972 573 |
| 09269-35010 |  972 688 |
| 09269-41001 |  971 612 |
| 09283-44009 | 971 455   |
| 43402-60G11 | 972 299   |
| 43402-60G21 | 972 973   |
| 43402-64B01 |  972 717 |
| 43485-67000 | 972 275   |
| 43491-70D00 | 972 275   |
| 44251-79000 | 972 275   |

**TALBOT**

|            |         |
|------------|---------|
| 17 540 300 | 601 446 |
| 18 01 176  | 602 881 |
| 50 07 031  | 602 833 |

 - Lager OEM / Bearing OEM / Roulement OEM



































## VERGLEICHNUMMERNLISTE

### CROSS REFERENCE GUIDE / LISTE DES ÉQUIVALENCES

#### TOYOTA

|             |   |         |
|-------------|---|---------|
| 04421-12010 |    | 982 650 |
| 04421-27010 |    | 982 685 |
| 04421-27010 |    | 982 764 |
| 04422-20020 |   | 981 407 |
| 04422-20110 |   | 981 407 |
| 40210-34B00 |    | 981 744 |
| 42409-909D0 |    | 982 379 |
| 42410-02040 |   | 982 201 |
| 42410-12090 |   | 982 201 |
| 42423-60030 |   | 982 288 |
| 42450-0H010 |   | 602 835 |
| 42450-33010 |    | 982 431 |
| 42450-42020 |    | 982 762 |
| 42450-52020 |   | 982 195 |
| 42450-52020 |    | 982 939 |
| 42451-28010 |   | 982 287 |
| 43521-60011 |   | 981 966 |
| 90080-36067 |   | 981 966 |
| 90080-36087 |   | 981 947 |
| 90080-36098 |   | 981 966 |
| 90177-22001 |   | 981 199 |
| 90178-22001 |   | 981 947 |
| 90208-48002 |   | 982 288 |
| 90214-42030 |   | 981 966 |
| 90301-85004 |   | 982 288 |
| 90310-58002 |   | 982 288 |
| 90311-41123 |   | 981 790 |
| 90311-48001 |   | 981 814 |
| 90311-70011 |   | 981 966 |
| 90363-35016 |  | 981 742 |
| 90363-40020 |  | 982 774 |
| 90363-40020 |  | 982 884 |
| 90363-40066 |   | 981 199 |
| 90363-40079 |   | 981 824 |
| 90363-W0001 |   | 981 149 |
| 90365-47013 |  | 982 581 |
| 90366-25003 |  | 982 816 |
| 90366-27001 |  | 982 561 |
| 90366-30001 |  | 982 437 |
| 90366-35004 |  | 981 579 |
| 90366-50011 |  | 981 683 |
| 90368-17017 |  | 981 535 |
| 90368-17017 |  | 982 561 |
| 90368-17017 |  | 982 816 |
| 90368-19037 |  | 981 447 |
| 90368-19037 |   | 981 814 |













#### TOYOTA

|             |   |         |
|-------------|---|---------|
| 90368-21082 |    | 981 798 |
| 90368-22007 |    | 981 579 |
| 90368-26027 |    | 981 535 |
| 90368-28001 |    | 981 655 |
| 90368-29068 |   | 981 790 |
| 90368-31067 |    | 981 447 |
| 90368-31067 |   | 981 814 |
| 90368-34083 |    | 981 798 |
| 90368-34083 |    | 982 437 |
| 90368-45087 |    | 190 256 |
| 90368-45087 |    | 191 258 |
| 90368-45087 |    | 981 499 |
| 90368-45087 |    | 981 533 |
| 90368-45087 |    | 981 683 |
| 90368-45087 |    | 982 811 |
| 90368-49084 |    | 190 256 |
| 90368-49084 |    | 191 258 |
| 90368-49084 |    | 981 499 |
| 90368-49084 |    | 981 533 |
| 90368-49084 |   | 982 811 |
| 90368-52043 |  | 982 653 |
| 90368-57010 |  | 982 653 |
| 90369-28006 |  | 981 747 |
| 90369-28006 |  | 982 778 |
| 90369-28006 |  | 982 780 |
| 90369-30044 |   | 981 283 |
| 90369-30044 |  | 982 766 |
| 90369-32003 |  | 981 849 |
| 90369-35034 |  | 981 805 |
| 90369-35064 |  | 982 800 |
| 90369-38003 |  | 980 614 |
| 90369-38003 |  | 981 407 |
| 90369-38003 |  | 981 572 |
| 90369-38003 |  | 981 616 |
| 90369-38003 |  | 982 737 |
| 90369-38003 |  | 982 749 |
| 90369-38006 |  | 981 763 |
| 90369-38006 |  | 981 851 |
| 90369-38011 |  | 981 690 |
| 90369-38011 |  | 981 856 |
| 90369-38011 |  | 981 868 |
| 90369-38022 |  | 981 938 |
| 90369-40003 |  | 982 813 |
| 90369-43005 |  | 982 559 |
| 90369-43007 |  | 981 944 |
| 90369-43008 |  | 981 475 |

#### TOYOTA

|             |   |         |
|-------------|---|---------|
| 90369-43008 |   | 982 289 |
| 90369-45002 |  | 982 945 |
| 90369-47001 |   | 982 287 |
| 90369-48001 |   | 982 288 |
| 90369-54001 |  | 981 952 |
| 90521-79002 |   | 981 407 |
| 90521-79002 |   | 981 947 |
| 90521-88001 |   | 982 289 |
| 90521-93003 |   | 982 287 |
| 90903-64002 |  | 981 743 |
| 90903-64002 |  | 981 745 |
| 95381-04025 |   | 981 790 |
| 97144-06308 |  | 192 274 |

#### VAG

|                |   |         |
|----------------|---|---------|
| 091 517 185 B  |    | 102 060 |
| 113 517 185 C  |    | 101 102 |
| 113 517 185 C  |    | 101 108 |
| 171 498 625    |   | 101 010 |
| 171 498 625 A  |   | 101 010 |
| 171 498 625 B  |   | 101 010 |
| 171 498 625 C  |   | 101 010 |
| 171 498 625 D  |   | 101 010 |
| 191 498 625    |   | 101 016 |
| 191 498 625 A  |   | 100 022 |
| 191 598 625    |   | 100 002 |
| 1D0 498 625 B  |   | 100 098 |
| 1H0 498 625    |   | 101 024 |
| 1J0 498 625    |   | 101 113 |
| 1J0 501 477 A  |  | 102 115 |
| 1J0 598 477    |   | 102 115 |
| 1K0 598 611    |   | 102 213 |
| 1T0 498 621    |   | 101 017 |
| 1T0 598 611    |   | 102 019 |
| 211 405 645 D  |  | 101 102 |
| 211 498 071    |   | 101 145 |
| 211 498 071 BS |   | 101 145 |
| 211 501 283 D  |  | 102 094 |
| 211 501 287    |  | 102 094 |
| 251 405 645 B  |  | 101 108 |
| 251 407 625    |  | 101 105 |
| 281 498 625    |   | 101 064 |
| 281 501 319    |  | 102 054 |
| 281 501 319    |  | 102 152 |
| 281 501 319    |  | 102 154 |
| 281 501 319    |  | 102 156 |
| 291 498 625    |   | 101 110 |

 - Lager OEM / Bearing OEM / Roulement OEM

## VERGLEICHNUMMERNLISTE

### CROSS REFERENCE GUIDE / LISTE DES ÉQUIVALENCES

**VAG**

|                |   |         |
|----------------|---|---------|
| 2D0 498 625    |   | 401 137 |
| 2D0 501 319    |    | 402 117 |
| 2D0 501 319 A  |    | 102 150 |
| 2D0 501 319 A  |    | 402 119 |
| 2D0 501 319 B  |    | 102 150 |
| 2D0 501 319 B  |    | 402 119 |
| 321 498 625 A  |   | 101 147 |
| 321 498 625 B  |   | 100 014 |
| 321 498 625 C  |   | 100 014 |
| 321 498 625 D  |   | 100 014 |
| 321 498 625 E  |   | 100 014 |
| 331 598 625    |   | 100 014 |
| 331 598 625 A  |   | 100 022 |
| 331 598 625 B  |   | 100 022 |
| 357 498 625    |   | 100 022 |
| 357 498 625 A  |   | 101 024 |
| 357 498 625 B  |   | 100 022 |
| 3X0 407 625    |    | 101 005 |
| 431 498 625    |   | 100 036 |
| 431 498 625 A  |   | 100 056 |
| 443 498 625    |   | 100 036 |
| 443 498 625 A  |   | 100 098 |
| 443 498 625 B  |   | 100 056 |
| 443 498 625 C  |   | 100 056 |
| 443 498 625 E  |   | 100 056 |
| 443 498 625 F  |   | 100 098 |
| 4A0 498 625    |   | 100 098 |
| 4A0 598 625    |   | 102 008 |
| 4A0 598 625 A  |   | 102 008 |
| 4B0 498 625    |   | 100 091 |
| 4B0 498 625 A  |   | 100 098 |
| 4B0 598 625 B  |   | 102 041 |
| 4D0 407 625 D  |  | 100 053 |
| 4D0 407 625 E  |  | 100 007 |
| 4D0 498 625 A  |   | 101 111 |
| 4E0 498 625    |   | 100 007 |
| 6E0 407 621 A  |  | 101 029 |
| 6E0 407 621 C  |   | 101 029 |
| 6E0 501 611    |  | 102 069 |
| 6E0 598 611    |   | 102 069 |
| 6K9 501 477    |  | 102 079 |
| 6N0 498 625    |   | 101 016 |
| 6Q0 407 621    |   | 101 027 |
| 6Q0 407 621 AF |   | 101 025 |
| 6Q0 407 621 F  |  | 101 025 |
| 6Q0 407 621 H  |  | 101 027 |







**VAG**

|                |   |         |
|----------------|---|---------|
| 6Q0 501 611 F  |    | 102 077 |
| 6Q0 598 611    |   | 102 077 |
| 6U0 598 625    |   | 100 002 |
| 6X0 501 477    |    | 102 075 |
| 6X0 598 477    |   | 102 075 |
| 701 498 625    |   | 101 128 |
| 701 501 287 F  |    | 102 207 |
| 701 598 625    |   | 100 206 |
| 701 598 625 A  |   | 100 206 |
| 701 598 625 B  |   | 102 207 |
| 7D0 498 625    |   | 101 209 |
| 7L0 498 287    |   | 100 003 |
| 7L0 498 611    |   | 100 013 |
| 7M0 498 625    |   | 131 129 |
| 7M0 598 625    |   | 132 131 |
| 861 498 625    |   | 101 044 |
| 871 498 625    |   | 101 044 |
| 871 498 625 A  |   | 101 044 |
| 893 498 625 C  |   | 100 099 |
| 893 498 625 D  |   | 100 090 |
| 893 498 625 E  |   | 100 099 |
| 8A0 498 625    |   | 100 090 |
| 8D0 498 625    |   | 100 091 |
| 8D0 498 625 A  |   | 101 111 |
| 8D0 498 625 B  |   | 100 098 |
| 8D0 498 625 C  |   | 100 053 |
| 8D0 598 625    |   | 102 055 |
| 8D0 598 625 A  |   | 100 093 |
| 8E0 498 625 A  |   | 100 053 |
| 8E0 501 611    |  | 102 011 |
| 8E0 598 611    |   | 102 071 |
| 8E0 598 611 A  |   | 102 071 |
| 8E0 598 625    |   | 102 097 |
| J90 363 400 20 |  | 192 274 |
| J90 368 450 87 |  | 190 256 |
| J90 368 450 87 |  | 191 258 |
| J90 368 490 84 |  | 190 256 |
| J90 368 490 84 |  | 191 258 |

**VOLVO**

|          |   |         |
|----------|---|---------|
| 1387203  |  | 892 468 |
| 270160-5 |   | 891 520 |
| 271262   |   | 892 458 |
| 271391   |   | 891 522 |
| 271392   |   | 891 520 |
| 271394-9 |   | 891 482 |
| 271449   |   | 891 536 |

**VOLVO**















|           |   |         |
|-----------|---|---------|
| 271450-9  |   | 891 466 |
| 271585    |   | 892 733 |
| 271589    |   | 891 544 |
| 271591    |   | 891 544 |
| 271643    |   | 891 482 |
| 271644    |   | 891 466 |
| 271645    |   | 891 536 |
| 271786    |   | 891 628 |
| 271786-6  |   | 891 469 |
| 271795    |   | 892 735 |
| 271905    |   | 891 333 |
| 272456    |   | 891 869 |
| 273747-6  |   | 891 822 |
| 273824-3  |   | 891 522 |
| 273872-2  |   | 892 460 |
| 30639875  |   | 891 591 |
| 30639877  |   | 892 929 |
| 30812651  |   | 892 843 |
| 30819062  |   | 892 843 |
| 3105765   |  | 892 804 |
| 3294713-7 |  | 892 802 |
| 3411886-9 |  | 892 474 |
| 3450524   |  | 892 470 |
| 3454197   |  | 891 484 |
| 3454197   |  | 891 486 |
| 8624647   |   | 892 929 |
| 9173872   |   | 892 872 |
| 9173991   |   | 891 878 |

 - Lager OEM / Bearing OEM / Roulement OEM



## VERGLEICHNUMMERNLISTE

### CROSS REFERENCE GUIDE / LISTE DES ÉQUIVALENCES





#### ALFA ROMEO

|         |            |   |
|---------|------------|---|
| 801 428 | 60 75 1080 |    |
| 801 428 | 60 80 1380 |    |
| 801 478 | 60 55 4002 |    |
| 801 500 | 60 51 0366 |    |
| 801 588 | 101369     |    |
| 801 588 | 60 70 9431 |    |
| 801 970 | 71 71 4478 |   |
| 801 972 | 60 81 5903 |   |
| 802 335 | 60 56 8138 |   |
| 802 485 | 60 61 3615 |   |
| 802 488 | 60 53 7081 |    |
| 802 526 | 60 80 8903 |   |
| 802 528 | 82 39 0273 |    |
| 802 540 | 60 55 4002 |    |
| 802 542 | 60 55 4002 |    |
| 802 556 | 60 55 4002 |    |
| 802 558 | 60 55 4002 |    |
| 802 560 | 60 51 0129 |   |
| 802 562 | 82 41 8685 |  |
| 802 646 | 60 53 7081 |  |
| 802 839 | 60 81 6007 |   |
| 802 870 | 60 65 2014 |   |
| 802 888 | 60 65 2720 |   |



#### BMW

|         |                 |   |
|---------|-----------------|---|
| 501 049 | 31 21 2 225 362 |  |
| 501 088 | 31 21 1 128 157 |   |
| 501 092 | 31 21 1 119 571 |   |
| 501 092 | 31 21 9 061 512 |   |
| 501 112 | 31 21 1 128 569 |   |
| 501 112 | 31 21 1 131 297 |   |
| 501 114 | 31 21 1 131 298 |   |
| 501 121 | 31 20 1 095 616 |   |
| 501 121 | 31 22 1 093 427 |   |
| 501 133 | 31 21 1 137 966 |   |
| 501 133 | 31 22 1 092 519 |   |
| 501 136 | 31 22 1 139 345 |   |
| 501 136 | 31 22 1 468 926 |   |
| 501 147 | 31 22 6 750 217 |   |
| 501 161 | 31 22 6 756 889 |   |
| 501 170 | 31 21 1 129 386 |   |
| 501 170 | 31 21 2 226 640 |   |
| 501 184 | 31 21 1 107 456 |   |
| 501 194 | 31 21 1 107 447 |   |
| 501 194 | 31 21 9 061 511 |   |
| 502 066 | 33 41 1 123 415 |  |
| 502 068 | 33 41 1 124 358 |  |

#### BMW

|         |                 |   |
|---------|-----------------|---|
| 502 070 | 33 41 1 123 426 |   |
| 502 070 | 33 41 1 133 124 |   |
| 502 072 | 33 41 1 130 617 |  |
| 502 109 | 33 41 1 130 617 |  |
| 502 123 | 33 41 1 095 652 |   |
| 502 125 | 33 41 1 124 358 |  |
| 502 134 | 33 41 1 108 408 |   |
| 502 135 | 33 41 1 090 505 |  |
| 502 138 | 33 41 1 124 358 |  |
| 502 148 | 33 41 1 130 617 |  |
| 502 158 | 33 41 1 120 038 |   |
| 502 163 | 33 41 6 756 830 |   |
| 502 178 | 33 41 1 107 512 |   |
| 502 178 | 33 41 1 119 138 |   |
| 502 252 | 33 41 1 095 238 |   |







#### CHRYSLER

|         |         |   |
|---------|---------|---|
| 991 898 | 4641196 |  |
| 991 998 | 5241067 |  |















#### DAEWOO

|         |            |  |
|---------|------------|--|
| 971 290 | 4142503203 |  |
| 971 290 | 4143103210 |  |
| 971 290 | 4143203210 |  |
| 971 391 | 90222850   |  |
| 971 391 | 90279332   |  |
| 971 393 | 926739001  |  |
| 971 393 | 926739005  |  |
| 971 393 | 938175001  |  |
| 971 917 | 96285525   |  |
| 971 940 | 96207566   |  |
| 972 389 | 926517101  |  |
| 972 389 | 926517201  |  |
| 972 389 | 926529001  |  |
| 972 397 | 90510629   |  |
| 972 397 | 90540069   |  |











#### DAIHATSU

|         |             |   |
|---------|-------------|---|
| 901 231 | 90043-63252 |   |
| 901 231 | 90043-63253 |   |
| 901 425 | 90043-63188 |  |
| 901 427 | 90043-11188 |   |
| 901 427 | 90043-63087 |  |
| 901 429 | 43246-87701 |   |
| 901 429 | 90043-63150 |  |
| 901 445 | 0211-27-305 |  |
| 901 445 | 0613-27-305 |  |
| 901 461 | 90043-63087 |  |
| 901 549 | 09265-35004 |   |

#### DAIHATSU

|         |             |   |
|---------|-------------|---|
| 901 549 | 90043-66044 |   |
| 901 876 | 90043-11201 |  |
| 901 876 | 90043-11202 |  |
| 901 890 | 97600-30203 |  |
| 901 890 | 97600-32005 |  |
| 901 895 | 90046-66023 |  |
| 901 896 | 90046-66023 |  |
| 902 443 | 90043-63100 |  |
| 902 457 | 90043-63013 |  |
| 902 457 | 90043-63079 |  |
| 902 459 | 90043-63010 |  |
| 902 459 | 90043-63012 |  |
| 902 547 | 42410-87703 |  |
| 902 771 | 42410-87703 |  |
| 902 855 | 90043-66039 |  |
| 902 999 | 90043-63012 |  |
| 902 999 | 90043-63256 |  |

#### FIAT















|         |            |   |
|---------|------------|---|
| 681 259 | 71 73 2444 |   |
| 681 261 | 71 73 1547 |   |
| 681 303 | 9567217680 |   |
| 681 325 | 1300535080 |  |
| 681 504 | 43 30 647  |  |
| 681 506 | 43 30 647  |  |
| 681 640 | 26 20 4009 |  |
| 681 923 | 93 82 4579 |   |
| 682 305 | 9567217780 |   |
| 682 925 | 71 80 066  |   |
| 800 304 | 59 41 7980 |   |
| 800 366 | 58 90 9920 |   |
| 800 398 | 58 90 9870 |   |
| 800 400 | 58 90 9860 |   |
| 800 400 | 58 90 9880 |   |
| 800 408 | 58 91 1940 |   |
| 801 267 | 71 72 9124 |   |
| 801 342 | 44 00 9180 |   |
| 801 342 | 58 90 9940 |   |
| 801 360 | 58 90 9890 |   |
| 801 360 | 75 55 4660 |  |
| 801 362 | 75 55 4660 |  |
| 801 364 | 46 42 3870 |  |
| 801 372 | 82 37 4669 |  |
| 801 376 | 58 90 9900 |   |
| 801 382 | 43 39 3080 |  |
| 801 450 | 58 90 9910 |   |
| 801 500 | 60 51 0366 |  |

 - Lager OEM / Bearing OEM / Roulement OEM

## VERGLEICHNUMMERNLISTE

### CROSS REFERENCE GUIDE / LISTE DES ÉQUIVALENCES

**FIAT**

|         |            |   |
|---------|------------|---|
| 801 644 | 26 80 0140 |    |
| 801 644 | 26 80 0330 |    |
| 801 730 | 82 39 0273 |    |
| 801 746 | 40 96 5870 |    |
| 801 750 | 26 80 0140 |    |
| 801 750 | 26 80 0330 |    |
| 801 836 | 71 71 4459 |   |
| 801 838 | 46 77 3662 |    |
| 801 838 | 71 74 4570 |   |
| 801 880 | 46 43 9334 |    |
| 801 880 | 71 71 4464 |   |
| 801 950 | 71 71 4458 |   |
| 801 961 | 71 72 9122 |   |
| 801 972 | 71 71 4462 |   |
| 801 974 | 71 72 9125 |   |
| 802 233 | 71 72 9123 |   |
| 802 265 | 50 70 1247 |   |
| 802 271 | 46 55 4134 |   |
| 802 315 | 77 69 9020 |   |
| 802 318 | 75 99 4610 |  |
| 802 324 | 75 99 4610 |  |
| 802 330 | 71 71 4476 |   |
| 802 330 | 71 71 4477 |   |
| 802 330 | 76 03 6790 |  |
| 802 368 | 82 40 3117 |   |
| 802 370 | 82 46 9083 |   |
| 802 378 | 76 13 5140 |   |
| 802 394 | 44 00 9190 |   |
| 802 444 | 59 63 0340 |   |
| 802 526 | 82 46 2175 |   |
| 802 601 | 77 46 191  |   |
| 802 605 | 46 53 0316 |   |
| 802 740 | 71 60 3600 |  |
| 802 740 | 71 62 1910 |  |
| 802 748 | 71 62 1910 |  |
| 802 839 | 71 71 4463 |   |
| 802 839 | 71 71 4471 |   |
| 802 980 | 46 55 4135 |   |

**FORD**

|         |           |  |
|---------|-----------|--|
| 131 129 | 1 001 718 |  |
| 132 131 | 1 001 719 |  |
| 300 004 | 5 007 028 |  |
| 300 004 | 5 008 557 |  |
| 300 052 | 5 007 027 |  |
| 300 062 | 5 007 029 |  |
| 301 006 | 5 007 040 |  |



















**FORD**

|         |           |  |
|---------|-----------|--|
| 301 018 | 5 007 039 |  |
| 301 034 | 5 008 716 |  |
| 301 038 | 5 010 762 |  |
| 301 039 | 1 085 568 |  |
| 301 045 | 1 085 569 |  |
| 301 118 | 5 025 899 |  |
| 301 130 | 5 013 161 |  |
| 301 132 | 1 088 380 |  |
| 301 132 | 5 024 196 |  |
| 301 139 | 5 030 223 |  |
| 301 141 | 5 030 224 |  |
| 301 151 | 5 007 030 |  |
| 301 180 | 5 020 656 |  |
| 301 180 | 5 024 195 |  |
| 301 182 | 5 027 620 |  |
| 301 183 | 1 133 023 |  |
| 301 185 | 4 052 783 |  |
| 301 198 | 5 027 447 |  |
| 301 200 | 5 027 448 |  |
| 301 230 | 5 007 037 |  |
| 301 232 | 5 007 038 |  |
| 301 244 | 5 012 346 |  |
| 301 246 | 5 012 477 |  |
| 301 280 | 5 007 026 |  |
| 301 511 | 1 225 764 |  |
| 302 037 | 1 057 808 |  |
| 302 046 | 5 008 715 |  |
| 302 057 | 1 085 565 |  |
| 302 058 | 1 019 561 |  |
| 302 058 | 5 020 654 |  |
| 302 058 | 5 020 655 |  |
| 302 058 | 5 030 537 |  |
| 302 058 | 5 030 538 |  |
| 302 067 | 1 046 767 |  |
| 302 074 | 5 011 392 |  |
| 302 076 | 5 011 391 |  |
| 302 120 | 5 012 347 |  |
| 302 122 | 5 012 478 |  |
| 302 124 | 5 015 650 |  |
| 302 146 | 5 007 033 |  |
| 302 160 | 5 007 035 |  |
| 302 162 | 5 007 041 |  |
| 302 164 | 5 025 900 |  |
| 302 166 | 5 025 901 |  |
| 302 172 | 5 007 036 |  |
| 302 174 | 5 015 586 |  |

**FORD**

|         |           |  |
|---------|-----------|--|
| 302 176 | 5 015 587 |  |
| 302 186 | 5 027 621 |  |
| 302 188 | 5 027 622 |  |
| 302 190 | 5 027 623 |  |
| 302 192 | 5 027 624 |  |
| 302 196 | 5 027 625 |  |
| 302 197 | 1 115 019 |  |
| 302 197 | 1 146 689 |  |
| 302 208 | 5 012 470 |  |
| 302 234 | 5 007 114 |  |
| 302 240 | 5 019 971 |  |
| 302 248 | 5 024 251 |  |
| 302 254 | 5 007 034 |  |
| 302 255 | 4 164 671 |  |
| 302 257 | 4 164 670 |  |
| 302 260 | 5 025 675 |  |

**HONDA**

|         |               |   |
|---------|---------------|---|
| 201 262 | 8-94227-041   |   |
| 201 262 | 8-94258-819   |  |
| 881 704 | 44300-SE0-004 |  |
| 911 375 | 91051-SB0-010 |  |
| 911 377 | 44300-SR3-004 |  |
| 911 383 | 44300-SR3-A02 |  |
| 911 385 | 44200-SM4-018 |  |
| 911 387 | 42200-SM4-J51 |  |
| 911 399 | 44300-SG0-008 |  |
| 911 513 | 91051-692-003 |  |
| 911 600 | 44300-SB2-962 |  |
| 911 621 | 91051-689-003 |  |
| 911 623 | 91051-689-003 |  |
| 911 625 | 91051-689-003 |  |
| 911 629 | 91051-689-003 |  |
| 911 777 | 44300-SF1-008 |  |
| 911 782 | 91051-SA7-013 |  |
| 911 968 | 44200-SX0-008 |   |
| 911 969 | 44300-SP0-008 |   |
| 912 193 | 42200-S04-951 |   |
| 912 292 | 42200-SV4-N51 |   |
| 912 293 | 42200-SZ3-951 |   |
| 912 294 | 42200-ST7-R51 |   |
| 912 295 | 42200-S30-008 |   |
| 912 295 | 42200-S30-951 |   |
| 912 295 | 42200-S30-C11 |   |
| 912 296 | 42200-S30-J51 |   |
| 912 401 | 42200-SS0-981 |  |
| 912 403 | 42200-SM4-A01 |  |

 Lager OEM / Bearing OEM / Roulement OEM

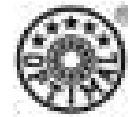

**VERGLEICHNUMMERNLISTE**

**CROSS REFERENCE GUIDE / LISTE DES ÉQUIVALENCES**

**HONDA**

|         |               |  |
|---------|---------------|--|
| 912 423 | 42200-SR3-A53 |  |
| 912 471 | 44200-SB2-003 |  |
| 912 473 | 91252-692-931 |  |
| 912 518 | 42200-SM4-J51 |  |
| 912 530 | 44200-S04-005 |  |
| 912 530 | 44200-SB2-015 |  |
| 912 532 | 42200-SE0-004 |  |
| 912 545 | 42300-SF1-008 |  |
| 912 775 | 42200-SM4-013 |  |
| 912 803 | 42200-SS0-981 |  |
| 912 804 | 42200-S1A-E01 |  |
| 912 809 | 42300-S2L-004 |  |
| 912 809 | 42300-S2L-008 |  |
| 912 990 | 42200-SR3-A4  |  |
| 912 991 | 42200-SX0-951 |  |
| 912 992 | 42200-SP0-951 |  |
| 912 992 | 42200-SP0-952 |  |
| 912 992 | 42200-SP0-953 |  |

**HYUNDAI**

|         |             |  |
|---------|-------------|--|
| 921 895 | 51720-3A101 |  |
| 921 906 | 51720-2D000 |  |
| 922 187 | 52713-21100 |  |
| 922 189 | 52710-25100 |  |
| 922 189 | 52710-25101 |  |
| 922 781 | 52710-29400 |  |
| 922 783 | 52710-25450 |  |
| 922 875 | 52710-3A000 |  |
| 922 877 | 52710-26500 |  |
| 922 921 | 52710-29461 |  |
| 922 979 | 52710-29150 |  |
| 922 979 | 52710-29450 |  |
| 922 979 | 52710-29470 |  |
| 922 979 | 52710-29471 |  |
| 951 282 | 51720-34200 |  |
| 951 962 | 51720-29150 |  |

**ISUZU**

|         |               |  |
|---------|---------------|--|
| 931 649 | 9-00093-149   |  |
| 931 649 | 9-00093-172   |  |
| 931 930 | 8-94248-077   |  |
| 931 930 | 9-00093-173   |  |
| 932 665 | 9-00093-081   |  |
| 932 665 | 9-00093-082   |  |
| 932 794 | 9-00094-627-2 |  |
| 932 864 | 8-94429-847   |  |
| 932 933 | 9-00032-209   |  |

**JAGUAR**

|         |         |  |
|---------|---------|--|
| 880 493 | JLM 258 |  |
|---------|---------|--|

**KIA**

|         |              |  |
|---------|--------------|--|
| 922 179 | OK9A2-26-150 |  |
| 922 181 | OK9A4-26-150 |  |
| 922 787 | OK202-26150  |  |
| 922 789 | OK216-26150  |  |
| 941 281 | 0S083-33075  |  |

**LADA**

|         |               |  |
|---------|---------------|--|
| 801 442 | 21083103020   |  |
| 801 656 | 2121310302010 |  |
| 802 454 | 21012403080   |  |
| 802 590 | 21212403080   |  |
| 802 658 | 21083104020   |  |

**LANCIA**

|         |            |  |
|---------|------------|--|
| 801 836 | 71 71 4459 |  |
| 802 331 | 46 42 6612 |  |
| 802 620 | 82 37 4669 |  |
| 802 839 | 71 71 4471 |  |

**MAZDA**

|         |              |  |
|---------|--------------|--|
| 940 371 | FB01-26-151A |  |
| 940 632 | B001-33-047  |  |
| 941 497 | 0259-33-047  |  |
| 941 497 | 8531-33-075  |  |
| 941 511 | 9960-30-204  |  |
| 941 511 | 9960-30-206  |  |
| 941 563 | 0259-33-047  |  |
| 941 565 | S083-33-047  |  |
| 941 565 | S083-33-075  |  |
| 941 602 | H266-26-151  |  |
| 941 617 | 1391-33-075  |  |
| 941 617 | B001-33-047  |  |
| 941 634 | B001-33-047  |  |
| 941 636 | B001-33-047  |  |
| 941 636 | B092-33-067  |  |
| 941 647 | 1391-33-075  |  |
| 941 647 | 8545-33-047  |  |
| 941 673 | FB05-49-060  |  |
| 941 687 | S083-33-047  |  |
| 941 687 | S121-33-075A |  |
| 941 689 | 1391-33-075  |  |
| 941 689 | B216-26-17X  |  |
| 941 691 | S083-33-047  |  |
| 941 691 | S083-33-075  |  |
| 941 700 | B260-33-048  |  |
| 941 700 | B455-33-047B |  |
| 941 734 | H001-26-151  |  |

**MAZDA**





|         |              |  |
|---------|--------------|--|
| 941 784 | H260-33-047  |  |
| 941 786 | B092-26-075  |  |
| 941 786 | G401-17-190  |  |
| 941 840 | B455-33-047C |  |
| 941 842 | NA01-33-04X  |  |
| 941 862 | GA5R-26-15X  |  |
| 941 873 | B002-33-075  |  |
| 941 873 | G401-17-190  |  |
| 941 874 | B001-33-047  |  |
| 941 951 | NA01-33-04XA |  |
| 941 967 | LA01-33-04XB |  |
| 941 967 | LB83-33-060  |  |
| 942 177 | D102-26-15X  |  |
| 942 177 | D201-26-15X  |  |
| 942 273 | G14V-26-15X  |  |
| 942 273 | G14V-26-15XA |  |
| 942 273 | G14V-26-15XB |  |
| 942 273 | LA01-33-042B |  |
| 942 291 | GE4V-26-15XA |  |
| 942 381 | GE4V-26-15X  |  |
| 942 501 | 1011-26-151  |  |
| 942 566 | B002-33-047  |  |
| 942 566 | B092-26-075  |  |
| 942 568 | B092-26-075  |  |
| 942 568 | B092-26-175  |  |
| 942 569 | B455-26-15XA |  |
| 942 570 | B092-26-075  |  |
| 942 570 | B092-26-175  |  |
| 942 619 | 4122-26-151  |  |
| 942 651 | 9960-32-011  |  |
| 942 671 | FB01-26-151A |  |
| 942 672 | GJ21-26-151  |  |
| 942 672 | GJ21-33-042B |  |
| 942 674 | B002-33-047  |  |
| 942 674 | B002-33-075  |  |
| 942 693 | 9960-30-208  |  |
| 942 695 | 9960-30-208  |  |
| 942 736 | H266-26-151  |  |
| 942 738 | H001-26-151  |  |
| 942 754 | 9960-30-208  |  |
| 942 768 | B002-33-047  |  |
| 942 768 | B002-33-075  |  |
| 942 770 | B002-33-047  |  |
| 942 770 | B002-33-075  |  |
| 942 773 | B603-26-15XB |  |
| 942 788 | 8871-26-151A |  |

- Lager OEM / Bearing OEM / Roulement OEM











## VERGLEICHSNUMMERNLISTE

### CROSS REFERENCE GUIDE / LISTE DES ÉQUIVALENCES









**MAZDA**

|         |              |   |
|---------|--------------|---|
| 942 818 | 1391-33-047  |  |
| 942 818 | B092-26-075  |  |
| 942 820 | 1391-33-047  |  |
| 942 820 | B092-26-075  |  |
| 942 987 | G238-26-151  |   |
| 942 987 | G717-26-139  |   |
| 942 987 | G717-26-154  |   |
| 942 987 | GJ21-33-042B |   |
| 942 988 | J001-26-139  |   |
| 942 988 | J001-26-151  |   |
| 942 989 | LB40-26-151  |  |





















**MERCEDES**

|         |               |   |
|---------|---------------|---|
| 400 051 | 163 330 00 51 |   |
| 400 061 | 210 330 01 51 |   |
| 400 107 | 202 981 01 27 |    |
| 401 028 | 116 330 00 51 |   |
| 401 028 | 116 586 00 33 |   |
| 401 042 | 201 330 02 51 |   |
| 401 047 | 168 981 06 27 |  |
| 401 048 | 201 330 01 51 |   |
| 401 078 | 129 330 00 51 |   |
| 401 078 | 202 330 00 51 |   |
| 401 078 | 210 330 00 51 |   |
| 401 082 | 140 330 00 51 |   |
| 401 082 | 140 330 02 51 |   |
| 401 083 | 220 330 07 25 |   |
| 401 096 | 124 330 00 51 |   |
| 401 096 | 124 330 01 51 |   |
| 401 100 | 000 980 42 02 |  |
| 401 100 | 000 980 82 02 |  |
| 401 104 | 000 980 42 02 |  |
| 401 104 | 000 980 82 02 |  |
| 401 126 | 126 330 00 51 |   |
| 401 137 | 003 981 10 05 |  |
| 401 137 | 608 981 00 05 |  |
| 401 137 | 611 330 08 25 |   |
| 401 157 | 203 330 00 51 |   |
| 401 212 | 007 981 04 05 |  |
| 401 212 | 009 981 41 05 |  |
| 401 214 | 631 330 00 51 |   |
| 401 214 | 631 330 02 51 |   |
| 401 222 | 115 330 00 51 |   |
| 401 222 | 115 586 03 33 |   |
| 401 276 | 111 330 00 51 |   |
| 401 276 | 111 586 04 33 |   |
| 401 277 | 201 330 00 51 |   |

**MERCEDES**

|         |               |   |
|---------|---------------|---|
| 401 300 | 000 187 00 22 |   |
| 401 501 | 230 330 03 25 |   |
| 402 030 | 115 586 02 35 |   |
| 402 030 | 115 586 08 35 |   |
| 402 030 | 115 586 11 35 |   |
| 402 030 | 123 350 00 68 |   |
| 402 030 | 123 586 00 35 |   |
| 402 050 | 601 350 04 68 |   |
| 402 050 | 601 350 15 10 |   |
| 402 063 | 168 981 03 27 |    |
| 402 080 | 124 350 05 49 |   |
| 402 080 | 124 350 06 49 |   |
| 402 080 | 124 980 04 16 |   |
| 402 080 | 124 980 05 16 |   |
| 402 081 | 140 980 01 16 |    |
| 402 116 | 124 350 07 49 |   |
| 402 116 | 129 350 00 49 |   |
| 402 116 | 129 980 00 16 |   |
| 402 116 | 129 980 01 16 |   |
| 402 116 | 129 980 02 16 |   |
| 402 116 | 129 980 03 16 |   |
| 402 116 | 129 980 04 16 |   |
| 402 116 | 201 350 01 49 |   |
| 402 116 | 201 350 02 49 |   |
| 402 116 | 201 350 05 49 |   |
| 402 116 | 201 980 00 16 |   |
| 402 116 | 202 980 00 16 |   |
| 402 116 | 202 980 01 16 |   |
| 402 119 | 001 981 89 05 |  |
| 402 119 | 002 981 13 05 |  |
| 402 143 | 000 980 82 02 |  |
| 402 143 | 001 981 61 05 |  |
| 402 159 | 203 980 00 16 |   |
| 402 216 | 001 981 57 05 |  |
| 402 216 | 631 981 00 05 |  |
| 402 242 | 140 350 00 49 |   |
| 402 242 | 140 350 01 49 |   |
| 402 242 | 140 980 04 16 |   |
| 402 242 | 140 980 05 16 |   |
| 402 242 | 140 980 07 16 |   |
| 402 243 | 140 980 06 16 |   |
| 402 243 | 210 980 01 16 |   |
| 402 301 | 000 207 20 09 |   |
| 402 505 | 211 981 02 27 |   |
| 402 827 | 169 981 00 27 |   |

**MITSUBISHI**





|         |          |   |
|---------|----------|---|
| 920 752 | MA125842 |    |
| 920 752 | MA125843 |    |
| 951 284 | MB296739 |   |
| 951 409 | MB808442 |    |
| 951 449 | MB303865 |    |
| 951 519 | MB109051 |    |
| 951 604 | MB303865 |    |
| 951 606 | MB349416 |    |
| 951 657 | MB025006 |    |
| 951 657 | MT202119 |    |
| 951 659 | MB025004 |    |
| 951 659 | MB025005 |    |
| 951 708 | MB109564 |    |
| 951 708 | MB109565 |    |
| 951 722 | MB092749 |    |
| 951 756 | MB002072 |    |
| 951 756 | MB002073 |    |
| 951 971 | MB633429 |   |
| 951 971 | MB633430 |   |
| 951 971 | MB633432 |   |
| 951 971 | MB633434 |   |
| 951 971 | MB633435 |   |
| 952 279 | MB844220 |   |
| 952 297 | MB092440 |   |
| 952 297 | MB664611 |   |
| 952 297 | MB664612 |   |
| 952 297 | MB837719 |   |
| 952 297 | MR111877 |   |
| 952 405 | MB844919 |  |
| 952 415 | MB584790 |  |
| 952 417 | MB663557 |  |
| 952 551 | MB663630 |  |
| 952 577 | MB161132 |  |
| 952 577 | MT321624 |  |
| 952 593 | MB393210 |  |
| 952 608 | MB584326 |  |
| 952 661 | MB092432 |  |
| 952 676 | MB515471 |  |
| 952 678 | MB515470 |  |
| 952 679 | MB092177 |  |
| 952 679 | MB092185 |  |
| 952 710 | MB584761 |  |
| 952 758 | MB001315 |  |
| 952 769 | MB664611 |  |
| 952 809 | MB005395 |  |
| 952 809 | MB005396 |  |

 - Lager OEM / Bearing OEM / Roulement OEM























## VERGLEICHNUMMERNLISTE

### CROSS REFERENCE GUIDE / LISTE DES ÉQUIVALENCES

































#### MITSUBISHI

|         |          |   |
|---------|----------|---|
| 952 832 | MA125945 |    |
| 952 935 | MB001315 |    |
| 952 936 | MB664447 |    |
| 952 993 | MB092179 |   |
| 952 993 | MB290157 |   |
| 952 993 | MB290426 |   |
| 952 993 | MB290428 |   |
| 952 993 | MB393803 |   |
| 952 993 | MB393807 |   |
| 952 993 | MB569972 |   |
| 952 993 | MB569972 |   |
| 952 993 | MT191613 |   |
| 952 994 | MB584790 |   |
| 952 995 | MB663664 |   |
| 952 996 | MA125987 |   |
| 952 996 | MA151215 |   |
| 952 996 | MA181498 |   |
| 952 996 | MB886298 |   |
| 952 996 | MB886601 |   |
| 952 997 | MR103654 |   |
| 991 902 | MB864847 |  |
| 992 894 | MB864929 |  |







#### NISSAN

|         |             |   |
|---------|-------------|---|
| 960 578 | 40210-50A00 |  |
| 960 638 | 40210-30R01 |  |
| 960 702 | 40210-01E00 |  |
| 961 229 | 40210-4M400 |   |
| 961 411 | 40215-C6000 |  |
| 961 411 | 43210-C9300 |  |
| 961 479 | 40210-41B00 |  |
| 961 576 | 40210-01E00 |  |
| 961 610 | 40210-34B00 |  |
| 961 648 | 90369-38003 |  |
| 961 675 | 01014-10514 |  |
| 961 677 | 40210-F1700 |  |
| 961 677 | 40215-F1700 |  |
| 961 680 | 40215-M5600 |  |
| 961 701 | 40210-05U00 |  |
| 961 724 | 40210-A0100 |  |
| 961 724 | 40215-A0100 |  |
| 961 751 | 43210-35F01 |  |
| 961 753 | 40210-33P07 |  |
| 961 759 | 40210-F6600 |  |
| 961 765 | 40210-A0100 |  |
| 961 765 | 40215-A0100 |  |
| 961 792 | 40210-A0100 |  |

#### NISSAN

|         |              |   |
|---------|--------------|---|
| 961 792 | 40215-A0100  |    |
| 961 796 | 40215-M0205  |    |
| 961 801 | 40210-50W00  |    |
| 961 801 | 40215-D0100  |    |
| 961 808 | 40210-F1700  |    |
| 961 808 | 40215-F1700  |    |
| 961 883 | 40215-D0100  |    |
| 961 900 | 40210-2Y000  |   |
| 961 903 | 40210-A0100  |    |
| 961 903 | 40215-A0100  |    |
| 961 904 | 40210-C6000  |    |
| 961 904 | 40215-C6000  |    |
| 961 964 | 40200-0V010  |   |
| 961 965 | 40210-C6000  |   |
| 961 965 | 40227-C8200  |   |
| 961 965 | 40232-01J00  |   |
| 961 965 | 43210-C9300  |   |
| 962 241 | 43200-0M801  |   |
| 962 286 | 43210-21000  |   |
| 962 286 | 43215-F6100  |   |
| 962 286 | 43232-F6100  |   |
| 962 413 | 43210-01J10  |  |
| 962 435 | 40210-85000  |  |
| 962 481 | 43200-21B00  |  |
| 962 481 | 43200-48B11  |  |
| 962 481 | 43200-5F617  |   |
| 962 548 | 43202-34B00  |  |
| 962 603 | 40210-61501  |  |
| 962 605 | 43210-76000  |  |
| 962 605 | 43215-76000  |  |
| 962 682 | 40210-A0800  |  |
| 962 682 | 40215-A0100  |  |
| 962 684 | 43215-H5000  |  |
| 962 686 | 40210-85000  |  |
| 962 703 | 43200-50J05  |  |
| 962 705 | 43200-50J15  |  |
| 962 712 | 43200-50Y10  |  |
| 962 714 | 43200-50Y12  |  |
| 962 716 | 43210-50A00  |  |
| 962 718 | 43210-50A00  |  |
| 962 755 | 432834-40P05 |  |
| 962 757 | 432834-40P05 |  |
| 962 760 | 40215-A0100  |  |
| 962 760 | 43210-D0100  |  |
| 962 767 | 43210-21000  |  |
| 962 767 | 43215-21P05  |  |

#### NISSAN

|         |             |   |
|---------|-------------|---|
| 962 776 | 40215-A0100 |  |
| 962 776 | 43210-M7000 |  |
| 962 823 | 43202-CA000 |   |
| 962 841 | 43215-T3200 |  |
| 962 847 | 43210-T6200 |  |
| 962 853 | 43200-30R06 |  |
| 962 873 | 43200-AV700 |   |
| 962 897 | 43210-AG000 |   |
| 962 899 | 43215-T3200 |  |
| 962 903 | 43200-2Y000 |   |
| 962 905 | 43215-T3200 |  |
| 962 913 | 43210-C9300 |  |
| 962 949 | 43215-G8100 |   |
| 962 981 | 43200-70N05 |   |
| 962 984 | 43210-0C700 |   |
| 962 985 | 43085-42G00 |   |
| 962 985 | 43210-42G10 |   |
| 962 985 | 43232-9C500 |   |
| 962 985 | 43252-0F000 |   |
| 962 986 | 43200-2F500 |   |
| 962 986 | 43200-9F510 |   |

#### OPEL

|         |            |   |
|---------|------------|---|
| 200 012 | 16 03 065  |   |
| 200 012 | 16 03 193  |   |
| 200 012 | 90 005 147 |   |
| 200 012 | 90 486 463 |   |
| 200 020 | 16 03 109  |   |
| 200 020 | 16 04 286  |   |
| 200 020 | 90 016 721 |   |
| 200 020 | 90 486 457 |   |
| 201 031 | 16 03 210  |   |
| 201 032 | 16 03 191  |   |
| 201 032 | 90 486 460 |   |
| 201 033 | 16 03 208  |   |
| 201 035 | 16 03 209  |   |
| 201 040 | 16 03 192  |   |
| 201 040 | 90 486 458 |   |
| 201 043 | 16 03 211  |   |
| 201 084 | 03 26 180  |  |
| 201 084 | 16 03 194  |   |
| 201 084 | 90 235 571 |  |
| 201 084 | 90 486 467 |   |
| 201 085 | 44 08 669  |   |
| 201 085 | 91160087   |   |
| 201 089 | 44 08 668  |   |
| 201 089 | 91 160 086 |   |









 - Lager OEM / Bearing OEM / Roulement OEM



## VERGLEICHSDATENLISTE

### CROSS REFERENCE GUIDE / LISTE DES ÉQUIVALENCES

**OPEL**

|         |            |   |
|---------|------------|---|
| 201 095 | 3 28 980   |   |
| 201 095 | 91 95 608  |   |
| 201 210 | 16 03 195  |   |
| 201 210 | 90 510 544 |   |
| 201 228 | 16 03 196  |   |
| 201 228 | 90 510 542 |   |
| 201 262 | 3 30 019   |    |
| 201 262 | 3 30 020   |    |
| 201 262 | 94 227 041 |    |
| 201 262 | 94 258 819 |    |
| 201 517 | 16 03 143  |   |
| 201 621 | 16 03 253  |   |
| 201 621 | 93 178 651 |   |
| 201 623 | 16 03 254  |   |
| 201 623 | 93 178 652 |   |
| 202 021 | 16 04 007  |   |
| 202 021 | 91 96 286  |   |
| 202 023 | 42 02 40   |   |
| 202 023 | 91 96 298  |   |
| 202 026 | 16 04 287  |   |
| 202 026 | 90 486 461 |   |
| 202 059 | 16 04 005  |   |
| 202 059 | 91 17 760  |   |
| 202 065 | 16 03 193  |   |
| 202 101 | 44 08 277  |   |
| 202 101 | 91 159 917 |   |
| 202 140 | 16 04 004  |   |
| 202 140 | 16 04 303  |   |
| 202 140 | 16 04 307  |   |
| 202 140 | 90 511 494 |   |
| 202 140 | 90 540 262 |   |
| 202 140 | 91 20 129  |   |
| 202 142 | 16 04 003  |   |
| 202 142 | 16 04 302  |   |
| 202 142 | 16 04 306  |   |
| 202 142 | 90 510 629 |   |
| 202 142 | 90 540 069 |   |
| 202 142 | 91 20 128  |   |
| 202 153 | 4 14 300   |  |
| 202 153 | 91 143 341 |  |
| 202 155 | 4 14 301   |  |
| 202 155 | 91 149 606 |  |
| 202 168 | 16 04 292  |   |
| 202 168 | 90 486 468 |   |
| 202 202 | 16 04 212  |   |
| 202 202 | 16 04 290  |   |

**OPEL**

|         |            |
|---------|------------|
| 202 202 | 90 019 333 |
| 202 202 | 90 448 665 |
| 202 202 | 90 486 465 |
| 202 204 | 16 04 213  |
| 202 204 | 16 04 291  |
| 202 204 | 90 019 334 |
| 202 204 | 90 486 466 |
| 202 218 | 16 04 002  |
| 202 218 | 16 04 301  |
| 202 218 | 90 473 997 |
| 202 218 | 90 510 543 |
| 202 226 | 16 04 285  |
| 202 226 | 90 486 459 |
| 202 236 | 16 04 210  |
| 202 236 | 16 04 213  |
| 202 236 | 16 04 289  |
| 202 236 | 90 019 086 |
| 202 236 | 90 448 664 |
| 202 236 | 90 486 464 |
| 202 252 | 16 04 198  |
| 202 252 | 16 04 209  |
| 202 252 | 16 04 288  |
| 202 252 | 90 005 218 |
| 202 252 | 90 019 085 |
| 202 252 | 90 486 462 |
| 202 519 | 16 04 314  |
| 202 519 | 93 170 611 |
| 202 625 | 16 04 315  |
| 202 625 | 93 178 625 |
| 202 627 | 16 04 316  |
| 202 627 | 93 178 626 |
| 701 860 | 44 03 023  |
| 702 436 | 44 03 943  |







**PORSCHE**

|         |             |
|---------|-------------|
| 102 103 | 99905302000 |
|---------|-------------|

**PSA**

|         |            |
|---------|------------|
| 600 308 | 3307.56    |
| 600 308 | 3350.16    |
| 600 308 | 3350.33    |
| 600 308 | 95 619 160 |
| 600 334 | 3350.18    |
| 600 334 | 95 654 074 |
| 601 253 | 3350.72    |
| 601 306 | 3350.17    |
| 601 306 | 95 654 076 |
| 601 323 | 3350.31    |

**PSA**







|         |               |   |
|---------|---------------|---|
| 601 336 | 3350.20       |   |
| 601 336 | 95 619 161    |   |
| 601 348 | 3350.15       |    |
| 601 384 | 3748.09       |   |
| 601 396 | 3350.11       |   |
| 601 396 | 79 01 335 011 |   |
| 601 434 | 95 548 417    |   |
| 601 434 | 95 619 166    |   |
| 601 440 | 54 51 859     |   |
| 601 495 | 3350.07       |   |
| 601 502 | 95 577 213    |   |
| 601 580 | 3326.14       |    |
| 601 654 | 3350.06       |   |
| 601 675 | 3350.82       |   |
| 601 828 | 95 554 319    |   |
| 601 828 | 95 616 709    |   |
| 601 834 | 3748.85       |   |
| 601 916 | 3350.32       |   |
| 601 953 | 3350.69       |   |
| 602 249 | 3748.41       |   |
| 602 251 | 3748.76       |   |
| 602 314 | 3701.59       |   |
| 602 314 | 3748.32       |   |
| 602 320 | 3748.17       |   |
| 602 320 | 95 654 078    |   |
| 602 322 | 3350.19       |   |
| 602 322 | 3748.42       |   |
| 602 322 | 95 654 077    |   |
| 602 337 | 3748.28       |   |
| 602 338 | 3701.52       |   |
| 602 339 | 3748.29       |   |
| 602 340 | 3701.42       |   |
| 602 340 | 3748.15       |   |
| 602 340 | 95 496 146    |   |
| 602 340 | 95 619 162    |   |
| 602 341 | 95 666 965    |   |
| 602 343 | 3701.58       |   |
| 602 344 | 3307.58       |   |
| 602 344 | 3748.33       |   |
| 602 345 | 3748.36       |   |
| 602 347 | 3701.67       |   |
| 602 349 | 3701.68       |   |
| 602 349 | 3701.74       |   |
| 602 356 | 3748.30       |  |
| 602 356 | 95 637 150    |  |
| 602 358 | 54 28 352     |  |

 - Lager OEM / Bearing OEM / Roulement OEM

## VERGLEICHNUMMERNLISTE

### CROSS REFERENCE GUIDE / LISTE DES ÉQUIVALENCES





#### PSA

|         |               |   |
|---------|---------------|---|
| 602 358 | 95 619 163    |   |
| 602 361 | 3748.31       |   |
| 602 367 | 3748.35       |   |
| 602 369 | 3748.34       |   |
| 602 386 | 3748.38       |   |
| 602 388 | 3701.54       |   |
| 602 390 | 3350.12       |   |
| 602 392 | 95 619 164    |   |
| 602 406 | 3350.02       |   |
| 602 412 | 3326.10       |    |
| 602 414 | 3748.10       |   |
| 602 414 | 3748.13       |   |
| 602 414 | 95 562 212    |   |
| 602 416 | 95 619 158    |   |
| 602 418 | 75 523 458    |   |
| 602 430 | 3326.28       |    |
| 602 512 | 79 03 090 194 |    |
| 602 539 | 3326.09       |   |
| 602 541 | 3748.04       |   |
| 602 541 | 3748.05       |   |
| 602 645 | 3748.37       |   |
| 602 669 | 3748.77       |   |
| 602 681 | 3748.82       |   |
| 602 681 | 3748.86       |   |
| 602 815 | 3748.08       |   |
| 602 815 | 55 02 233     |   |
| 602 821 | 3326.09       |  |
| 602 835 | 3748.85       |   |
| 602 858 | 3730.21       |  |
| 602 859 | 3748.11       |   |
| 602 859 | 3748.14       |   |
| 602 865 | 54 51 860     |   |
| 602 926 | 3350.19       |  |
| 602 927 | 3748.69       |   |
| 602 937 | 3307.61       |   |
| 602 937 | 3748.33       |   |
| 602 955 | 3748.70       |   |
| 602 956 | 3748.74       |   |
| 681 261 | 3350.70       |   |
| 681 261 | 3350.81       |   |
| 681 303 | 3350.27       |   |
| 681 325 | 3350.24       |   |
| 681 325 | 3350.30       |   |
| 681 504 | 95 619 170    |   |
| 681 506 | 3350.21       |   |
| 681 506 | 3350.29       |   |















#### PSA

|         |            |  |
|---------|------------|--|
| 681 640 | 95 555 853 |  |
| 682 263 | 3350.71    |  |
| 682 305 | 3350.28    |  |
| 682 327 | 3350.25    |  |
| 682 329 | 3350.26    |  |
| 682 329 | 95 669 382 |  |
| 682 420 | 95 619 171 |  |
| 682 422 | 95 619 171 |  |
| 682 490 | 3350.23    |  |
| 682 492 | 3350.23    |  |
| 682 508 | 3350.22    |  |
| 682 510 | 3350.22    |  |
| 682 642 | 95 557 561 |  |

#### RENAULT







|         |               |   |
|---------|---------------|---|
| 201 085 | 77 01 206 848 |   |
| 201 089 | 77 01 206 847 |   |
| 202 101 | 77 01 206 849 |   |
| 700 245 | 77 01 206 771 |   |
| 700 310 | 77 01 205 779 |   |
| 700 310 | 77 01 464 049 |   |
| 700 310 | 77 03 090 353 |   |
| 701 247 | 77 01 207 358 |   |
| 701 302 | 77 01 205 778 |   |
| 701 302 | 77 01 462 469 |   |
| 701 302 | 77 01 465 181 |   |
| 701 307 | 77 01 205 780 |   |
| 701 307 | 77 01 463 987 |   |
| 701 307 | 77 01 467 803 |   |
| 701 307 | 77 01 467 860 |   |
| 701 319 | 77 01 205 778 |   |
| 701 319 | 77 01 462 469 |   |
| 701 319 | 77 01 465 181 |   |
| 701 326 | 77 01 462 020 |   |
| 701 326 | 77 01 463 231 |   |
| 701 326 | 77 03 090 222 |  |
| 701 332 | 77 01 460 639 |   |
| 701 346 | 77 01 464 049 |   |
| 701 374 | 77 01 460 637 |   |
| 701 404 | 77 01 205 692 |   |
| 701 404 | 77 01 462 021 |   |
| 701 424 | 77 03 090 199 |  |
| 701 432 | 77 01 462 019 |   |
| 701 726 | 50 00 390 129 |  |
| 701 728 | 50 00 390 129 |  |
| 701 826 | 77 01 460 638 |   |
| 701 852 | 77 01 469 682 |   |

#### RENAULT

|         |               |   |
|---------|---------------|---|
| 701 860 | 77 01 205 416 |   |
| 701 860 | 77 01 206 740 |   |
| 701 914 | 77 01 205 972 |   |
| 701 914 | 77 01 470 552 |   |
| 701 975 | 77 01 206 661 |   |
| 701 977 | 77 01 207 677 |   |
| 701 978 | 77 01 207 676 |   |
| 702 309 | 77 01 204 667 |   |
| 702 309 | 77 01 803 928 |    |
| 702 311 | 77 00 803 923 |    |
| 702 311 | 77 00 803 929 |    |
| 702 311 | 77 01 204 692 |   |
| 702 312 | 77 01 205 812 |   |
| 702 312 | 77 01 465 735 |   |
| 702 313 | 77 00 787 641 |    |
| 702 313 | 77 00 803 924 |    |
| 702 313 | 77 01 204 693 |   |
| 702 316 | 77 01 463 986 |   |
| 702 321 | 70 01 205 170 |   |
| 702 321 | 77 00 829 031 |  |
| 702 328 | 77 01 460 642 |   |
| 702 350 | 77 01 460 641 |   |
| 702 351 | 77 00 845 104 |  |
| 702 351 | 77 01 204 867 |   |
| 702 351 | 77 01 205 477 |   |
| 702 352 | 77 01 463 523 |   |
| 702 353 | 77 00 840 609 |  |
| 702 355 | 77 00 820 850 |  |
| 702 355 | 77 01 204 690 |   |
| 702 357 | 77 00 820 849 |  |
| 702 357 | 77 01 204 689 |   |
| 702 359 | 77 01 204 868 |   |
| 702 363 | 60 25 102 710 |   |
| 702 363 | 60 25 170 050 |   |
| 702 365 | 60 25 102 558 |   |
| 702 365 | 60 25 171 137 |   |
| 702 380 | 77 00 787 639 |  |
| 702 380 | 77 00 803 928 |  |
| 702 380 | 77 01 204 665 |   |
| 702 380 | 77 04 002 263 |   |
| 702 426 | 77 01 205 596 |   |
| 702 436 | 77 01 465 647 |   |
| 702 448 | 50 00 389 906 |  |
| 702 452 | 77 00 803 929 |  |
| 702 456 | 77 01 461 730 |   |
| 702 462 | 77 03 090 264 |  |

 - Lager OEM / Bearing OEM / Roulement OEM

**VERGLEICHNUMMERNLISTE**
**CROSS REFERENCE GUIDE / LISTE DES ÉQUIVALENCES**
**RENAULT**

|         |               |   |
|---------|---------------|---|
| 702 494 | 77 00 780 921 |  |
| 702 494 | 77 01 204 666 |  |
| 702 514 | 77 00 780 919 |  |
| 702 514 | 77 01 204 696 |  |
| 702 537 | 60 25 171 136 |   |
| 702 550 | 77 00 803 931 |  |
| 702 552 | 77 00 787 640 |  |
| 702 552 | 77 01 204 695 |   |
| 702 552 | 77 04 002 264 |   |
| 702 586 | 77 01 465 646 |   |
| 702 692 | 77 01 463 940 |   |
| 702 765 | 77 00 814 192 |   |
| 702 817 | 77 01 460 641 |   |
| 702 846 | 77 01 205 417 |   |
| 702 846 | 77 01 206 742 |   |
| 702 850 | 77 01 205 499 |   |
| 702 866 | 60 25 370 612 |   |
| 702 915 | 77 00 845 195 |  |
| 702 957 | 77 01 206 353 |   |
| 702 958 | 77 01 205 471 |   |
| 702 959 | 77 01 206 354 |   |
| 702 960 | 77 01 205 472 |   |
| 702 982 | 77 01 208 058 |   |
| 702 983 | 77 01 208 059 |   |







**ROVER**

|         |               |  |
|---------|---------------|--|
| 880 912 | ANR 5861      |  |
| 881 237 | GHK 1692      |  |
| 881 594 | GHK 1366      |  |
| 881 609 | GHK 1285      |  |
| 881 704 | GHK 1933      |  |
| 881 725 | GHK 1559      |  |
| 882 167 | GHK 1631      |  |
| 882 235 | GHK 1693      |  |
| 882 463 | GHK 1549      |  |
| 882 463 | GHK 1550      |  |
| 882 483 | GHK 1561      |  |
| 882 483 | GHK 1597      |  |
| 882 487 | GHK 1560      |  |
| 882 487 | GHK 1596      |  |
| 882 607 | GHK 1564      |  |
| 882 611 | GHK 1287      |  |
| 882 613 | GHK 1286      |  |
| 882 624 | GHK 1570      |  |
| 882 626 | GHK 1569      |  |
| 882 727 | RFM 001484EVA |  |
| 882 729 | CKP 7058EVA   |  |

**ROVER**

|         |          |  |
|---------|----------|--|
| 882 729 | GHK 1551 |  |
| 882 896 | GHK 1685 |  |

**SAAB**

|         |            |   |
|---------|------------|---|
| 891 496 | 89 71 103  |   |
| 891 509 | 89 22 205  |   |
| 891 524 | 91 04 209  |  |
| 891 546 | 89 52 996  |   |
| 891 630 | 46 89 923  |  |
| 891 706 | 91 04 209  |  |
| 891 887 | 46 89 923  |  |
| 892 476 | 89 52 5822 |   |
| 892 498 | 89 73 406  |  |
| 892 668 | 89 63 084  |  |
| 892 670 | 89 47 384  |   |
| 892 806 | 89 47 384  |   |

**SEAT**

|         |                 |   |
|---------|-----------------|---|
| 800 408 | 39 81 590       |   |
| 800 408 | SE 025 140 301A |   |
| 801 342 | 39 81 586       |   |
| 801 342 | XO 44 00 918    |  |
| 801 354 | 39 81 588       |   |
| 801 354 | 39 81 589       |   |
| 801 354 | SE 021 140 301A |   |
| 801 354 | SE 021 140 301B |   |
| 801 574 | 39 81 591       |   |
| 801 698 | 39 81 592       |   |
| 802 318 | 39 81 594       |   |
| 802 394 | 39 81 593       |   |
| 802 480 | 39 81 595       |   |



**SKODA**

|         |             |   |
|---------|-------------|---|
| 801 543 | 969 106 801 |  |
| 801 618 | 963 030 400 |  |
| 801 618 | 969 300 304 |  |
| 801 694 | 969 106 801 |  |
| 802 720 | 961 230 600 |  |



**SUBARU**

|         |             |  |
|---------|-------------|--|
| 971 285 | 28015-TA000 |  |
| 971 285 | 28016-TA000 |  |
| 971 615 | 6999-01010  |  |
| 971 627 | 7999-23040  |  |
| 971 631 | X9061-GA000 |  |
| 971 635 | 7999-23110  |  |
| 971 641 | 7230-34040  |  |
| 971 641 | 7230-34050  |  |
| 971 641 | 7230-38070  |  |
| 971 641 | 7999-23130  |  |

**SUBARU**

|         |             |   |
|---------|-------------|---|
| 971 707 | 28016-AA011 |  |
| 972 465 | 6210-14110  |   |
| 972 465 | 6210-14111  |   |
| 972 465 | 90610-0007  |  |
| 972 633 | 6999-00120  |   |
| 972 637 | 6999-00081  |   |
| 972 639 | 6999-00900  |   |
| 972 709 | 28015-AA090 |   |

**SUZUKI**

|         |             |   |
|---------|-------------|---|
| 971 451 | 09265-41001 |    |
| 971 455 | 09180-35005 |   |
| 971 455 | 09262-35012 |   |
| 971 455 | 09262-35032 |   |
| 971 455 | 09283-44009 |   |
| 971 567 | 09267-28002 |    |
| 971 575 | 09267-36001 |    |
| 971 612 | 09269-41001 |    |
| 971 711 | 09267-36002 |   |
| 971 723 | 09267-40001 |  |
| 972 275 | 09262-30030 |   |
| 972 275 | 43485-67000 |   |
| 972 275 | 43491-70D00 |   |
| 972 275 | 44251-79000 |   |
| 972 299 | 43402-60G11 |   |
| 972 453 | 08314-41163 |   |
| 972 453 | 08314-41168 |   |
| 972 453 | 08322-11167 |   |
| 972 453 | 08322-11168 |   |
| 972 453 | 09180-21001 |   |
| 972 453 | 09262-20069 |   |
| 972 453 | 09262-25061 |   |
| 972 571 | 09262-35009 |  |
| 972 573 | 09269-35009 |  |
| 972 688 | 09269-35010 |  |
| 972 699 | 09262-30030 |  |
| 972 715 | 09267-35003 |  |
| 972 717 | 43402-64B01 |  |
| 972 721 | 08123-62047 |   |
| 972 721 | 09180-21001 |   |
| 972 721 | 09262-25061 |   |
| 972 973 | 43402-60G21 |   |

**TALBOT**

































|         |            |  |
|---------|------------|--|
| 601 446 | 17 540 300 |  |
| 602 833 | 50 07 031  |  |
| 602 881 | 18 01 176  |  |

 - Lager OEM / Bearing OEM / Roulement OEM

## VERGLEICHNUMMERNLISTE

### CROSS REFERENCE GUIDE / LISTE DES ÉQUIVALENCES













#### TOYOTA

|         |             |   |
|---------|-------------|---|
| 190 256 | 90368-45087 |    |
| 190 256 | 90368-49084 |    |
| 191 258 | 90368-45087 |    |
| 191 258 | 90368-49084 |    |
| 192 274 | 97144-06308 |    |
| 602 835 | 42450-0H010 |   |
| 980 614 | 90369-38003 |    |
| 981 149 | 90363-W0001 |   |
| 981 199 | 90177-22001 |   |
| 981 199 | 90363-40066 |   |
| 981 283 | 90369-30044 |   |
| 981 407 | 04422-20020 |   |
| 981 407 | 04422-20110 |   |
| 981 407 | 90369-38003 |    |
| 981 407 | 90521-79002 |   |
| 981 447 | 90368-19037 |    |
| 981 447 | 90368-31067 |    |
| 981 475 | 90369-43008 |   |
| 981 499 | 90368-45087 |  |
| 981 499 | 90368-49084 |  |
| 981 533 | 90368-45087 |  |
| 981 533 | 90368-49084 |  |
| 981 535 | 90368-17017 |  |
| 981 535 | 90368-26027 |  |
| 981 572 | 90369-38003 |  |
| 981 579 | 90366-35004 |  |
| 981 579 | 90368-22007 |  |
| 981 616 | 90369-38003 |  |
| 981 655 | 90368-28001 |  |
| 981 683 | 90366-50011 |  |
| 981 683 | 90368-45087 |  |
| 981 690 | 90369-38011 |  |
| 981 742 | 90363-35016 |  |
| 981 743 | 90903-64002 |  |
| 981 744 | 40210-34B00 |  |
| 981 745 | 90903-64002 |  |
| 981 747 | 90369-28006 |  |
| 981 763 | 90369-38006 |  |
| 981 790 | 90311-41123 |   |
| 981 790 | 90368-29068 |   |
| 981 790 | 95381-04025 |   |
| 981 798 | 90368-21082 |  |
| 981 798 | 90368-34083 |  |
| 981 805 | 90369-35034 |  |
| 981 814 | 90311-48001 |   |
| 981 814 | 90368-19037 |   |



#### TOYOTA

|         |             |   |
|---------|-------------|---|
| 981 814 | 90368-31067 |   |
| 981 824 | 90363-40079 |   |
| 981 849 | 90369-32003 |    |
| 981 851 | 90369-38006 |    |
| 981 856 | 90369-38011 |    |
| 981 868 | 90369-38011 |    |
| 981 938 | 90369-38022 |    |
| 981 944 | 90369-43007 |    |
| 981 947 | 90080-36087 |   |
| 981 947 | 90178-22001 |   |
| 981 947 | 90521-79002 |   |
| 981 952 | 90369-54001 |    |
| 981 966 | 43521-60011 |   |
| 981 966 | 90080-36067 |   |
| 981 966 | 90080-36098 |   |
| 981 966 | 90214-42030 |   |
| 981 966 | 90311-70011 |   |
| 982 195 | 42450-52020 |   |
| 982 201 | 42410-02040 |   |
| 982 201 | 42410-12090 |   |
| 982 287 | 42451-28010 |   |
| 982 287 | 90369-47001 |   |
| 982 287 | 90521-93003 |   |
| 982 288 | 42423-60030 |   |
| 982 288 | 90208-48002 |   |
| 982 288 | 90301-85004 |   |
| 982 288 | 90310-58002 |   |
| 982 288 | 90369-48001 |   |
| 982 289 | 90369-43008 |   |
| 982 289 | 90521-88001 |   |
| 982 379 | 42409-909D0 |  |
| 982 431 | 42450-33010 |  |
| 982 437 | 90366-30001 |  |
| 982 437 | 90368-34083 |  |
| 982 559 | 90369-43005 |  |
| 982 561 | 90366-27001 |  |
| 982 561 | 90368-17017 |  |
| 982 581 | 90365-47013 |  |
| 982 650 | 04421-12010 |  |
| 982 653 | 90368-52043 |  |
| 982 653 | 90368-57010 |  |
| 982 685 | 04421-27010 |  |
| 982 737 | 90369-38003 |  |
| 982 749 | 90369-38003 |  |
| 982 762 | 42450-42020 |  |
| 982 764 | 04421-27010 |  |

#### TOYOTA











|         |             |   |
|---------|-------------|---|
| 982 766 | 90369-30044 |  |
| 982 774 | 90363-40020 |  |
| 982 778 | 90369-28006 |  |
| 982 780 | 90369-28006 |  |
| 982 800 | 90369-35064 |  |
| 982 811 | 90368-45087 |  |
| 982 811 | 90368-49084 |  |
| 982 813 | 90369-40003 |  |
| 982 816 | 90366-25003 |  |
| 982 816 | 90368-17017 |  |
| 982 884 | 90363-40020 |  |
| 982 939 | 42450-52020 |  |
| 982 945 | 90369-45002 |  |

#### VAG























|         |               |   |
|---------|---------------|---|
| 100 002 | 191 598 625   |   |
| 100 002 | 6U0 598 625   |   |
| 100 003 | 7L0 498 287   |   |
| 100 007 | 4D0 407 625E  |   |
| 100 007 | 4E0 498 625   |   |
| 100 013 | 7L0 498 611   |   |
| 100 014 | 321 498 625 B |   |
| 100 014 | 321 498 625 C |   |
| 100 014 | 321 498 625 D |   |
| 100 014 | 321 498 625 E |   |
| 100 014 | 331 598 625   |   |
| 100 022 | 191 498 625 A |   |
| 100 022 | 331 598 625 A |   |
| 100 022 | 331 598 625 B |   |
| 100 022 | 357 498 625   |   |
| 100 022 | 357 498 625 B |   |
| 100 036 | 431 498 625   |   |
| 100 036 | 443 498 625   |   |
| 100 053 | 4D0 407 625 D |  |
| 100 053 | 8D0 498 625 C |   |
| 100 053 | 8E0 498 625 A |   |
| 100 056 | 431 498 625 A |   |
| 100 056 | 443 498 625 B |   |
| 100 056 | 443 498 625 C |   |
| 100 056 | 443 498 625 E |   |
| 100 090 | 893 498 625 D |   |
| 100 090 | 8A0 498 625   |   |
| 100 091 | 4B0 498 625   |   |
| 100 091 | 8D0 498 625   |   |
| 100 093 | 8D0 598 625 A |   |
| 100 098 | 1D0 498 625 B |   |
| 100 098 | 443 498 625 A |   |

 - Lager OEM / Bearing OEM / Roulement OEM

**VERGLEICHNUMMERNLISTE**
**CROSS REFERENCE GUIDE / LISTE DES ÉQUIVALENCES**
**VAG**

|         |                |   |
|---------|----------------|---|
| 100 098 | 443 498 625 F  |   |
| 100 098 | 4A0 498 625    |   |
| 100 098 | 4B0 498 625 A  |   |
| 100 098 | 8D0 498 625 B  |   |
| 100 099 | 893 498 625 C  |   |
| 100 099 | 893 498 625 E  |   |
| 100 206 | 701 598 625    |   |
| 100 206 | 701 598 625 A  |   |
| 101 005 | 3X0 407 625    |    |
| 101 010 | 171 498 625    |   |
| 101 010 | 171 498 625 A  |   |
| 101 010 | 171 498 625 B  |   |
| 101 010 | 171 498 625 C  |   |
| 101 010 | 171 498 625 D  |   |
| 101 016 | 191 498 625    |   |
| 101 016 | 6N0 498 625    |   |
| 101 017 | 1T0 498 621    |   |
| 101 024 | 1H0 498 625    |   |
| 101 024 | 357 498 625 A  |   |
| 101 025 | 6Q0 407 621 AF |   |
| 101 025 | 6Q0 407 621 F  |  |
| 101 027 | 6Q0 407 621    |   |
| 101 027 | 6Q0 407 621 H  |  |
| 101 029 | 6E0 407 621 A  |  |
| 101 029 | 6E0 407 621 C  |   |
| 101 044 | 861 498 625    |   |
| 101 044 | 871 498 625    |   |
| 101 044 | 871 498 625 A  |   |
| 101 064 | 281 498 625    |   |
| 101 102 | 113 517 185 C  |  |
| 101 102 | 211 405 645 D  |  |
| 101 105 | 251 407 625    |  |
| 101 108 | 113 517 185 C  |  |
| 101 108 | 251 405 645 B  |  |
| 101 110 | 291 498 625    |   |
| 101 111 | 4D0 498 625 A  |   |
| 101 111 | 8D0 498 625 A  |   |
| 101 113 | 1J0 498 625    |   |
| 101 128 | 701 498 625    |   |
| 101 145 | 211 498 071    |   |
| 101 145 | 211 498 071 BS |   |
| 101 147 | 321 498 625 A  |   |
| 101 209 | 7D0 498 625    |   |
| 102 008 | 4A0 598 625    |   |
| 102 008 | 4A0 598 625 A  |   |
| 102 011 | 8E0 501 611    |  |







**VAG**

|         |                |   |
|---------|----------------|---|
| 102 019 | 1T0 598 611    |   |
| 102 041 | 4B0 598 625 B  |   |
| 102 054 | 281 501 319    |    |
| 102 055 | 8D0 598 625    |   |
| 102 060 | 091 517 185 B  |    |
| 102 069 | 6E0 501 611    |    |
| 102 069 | 6E0 598 611    |   |
| 102 071 | 8E0 598 611    |   |
| 102 071 | 8E0 598 611 A  |   |
| 102 075 | 6X0 501 477    |    |
| 102 075 | 6X0 598 477    |   |
| 102 077 | 6Q0 501 611 F  |    |
| 102 077 | 6Q0 598 611    |   |
| 102 079 | 6K9 501 477    |    |
| 102 094 | 211 501 283 D  |    |
| 102 094 | 211 501 287    |    |
| 102 097 | 8E0 598 625    |   |
| 102 115 | 1J0 501 477 A  |    |
| 102 115 | 1J0 598 477    |   |
| 102 150 | 2D0 501 319 A  |  |
| 102 150 | 2D0 501 319 B  |  |
| 102 152 | 281 501 319    |  |
| 102 154 | 281 501 319    |  |
| 102 156 | 281 501 319    |  |
| 102 207 | 701 501 287 F  |  |
| 102 207 | 701 598 625 B  |   |
| 102 213 | 1K0 598 611    |   |
| 131 129 | 7M0 498 625    |   |
| 132 131 | 7M0 598 625    |   |
| 190 256 | J90 368 450 87 |  |
| 190 256 | J90 368 490 84 |  |
| 191 258 | J90 368 450 87 |  |
| 191 258 | J90 368 490 84 |  |
| 192 274 | J90 363 400 20 |  |
| 401 137 | 2D0 498 625    |   |
| 402 117 | 2D0 501 319    |  |
| 402 119 | 2D0 501 319 A  |  |
| 402 119 | 2D0 501 319 B  |  |

**VOLVO**

|         |          |   |
|---------|----------|---|
| 891 333 | 271905   |   |
| 891 466 | 271450-9 |   |
| 891 466 | 271644   |   |
| 891 469 | 271786-6 |   |
| 891 482 | 271394-9 |   |
| 891 482 | 271643   |   |
| 891 484 | 3454197  |  |

**VOLVO**

|         |           |   |
|---------|-----------|---|
| 891 486 | 3454197   |    |
| 891 520 | 270160-5  |   |
| 891 520 | 271392    |   |
| 891 522 | 271391    |   |
| 891 522 | 273824-3  |   |
| 891 536 | 271449    |   |
| 891 536 | 271645    |   |
| 891 544 | 271589    |   |
| 891 544 | 271591    |   |
| 891 591 | 30639875  |   |
| 891 628 | 271786    |   |
| 891 822 | 273747-6  |   |
| 891 869 | 272456    |   |
| 891 878 | 9173991   |   |
| 892 458 | 271262    |   |
| 892 460 | 273872-2  |   |
| 892 468 | 1387203   |    |
| 892 470 | 3450524   |    |
| 892 474 | 3411886-9 |   |
| 892 733 | 271585    |   |
| 892 735 | 271795    |   |
| 892 802 | 3294713-7 |  |
| 892 804 | 3105765   |  |
| 892 843 | 30812651  |   |
| 892 843 | 30819062  |   |
| 892 872 | 9173872   |   |
| 892 929 | 30639877  |   |
| 892 929 | 8624647   |   |

 Lager OEM / Bearing OEM / Roulement OEM

## VERGLEICHNUMMERNLISTE

### CROSS REFERENCE GUIDE / LISTE DES ÉQUIVALENCES

| HK    | OPTIMAL | HK    | OPTIMAL | HK    | OPTIMAL |
|-------|---------|-------|---------|-------|---------|
| 06/01 | 802 528 | 10/30 | 101 128 | 13/05 | 962 703 |
| 06/03 | 802 335 | 10/31 | 101 016 | 13/06 | 962 601 |
| 06/04 | 802 870 | 10/32 | 102 075 | 13/07 | 962 899 |
| 06/05 | 801 554 | 10/33 | 102 207 | 13/08 | 961 411 |
| 06/06 | 802 485 | 10/34 | 101 209 | 13/09 | 960 578 |
| 06/10 | 801 588 | 10/36 | 102 041 | 13/10 | 961 796 |
| 06/11 | 801 238 | 10/37 | 102 055 | 13/13 | 961 503 |
| 06/12 | 981 535 | 10/38 | 100 053 | 13/14 | 961 680 |
| 06/14 | 801 438 | 10/39 | 100 053 | 13/15 | 961 883 |
| 06/15 | 801 478 | 10/40 | 100 206 | 13/16 | 961 904 |
| 06/16 | 801 428 | 10/41 | 100 098 | 13/17 | 961 576 |
| 06/20 | 802 652 | 10/42 | 100 098 | 13/18 | 961 792 |
| 06/22 | 802 556 | 10/43 | 100 053 | 13/21 | 962 718 |
| 06/22 | 802 558 | 10/45 | 131 129 | 13/22 | 962 684 |
| 06/24 | 802 646 | 10/46 | 132 131 | 13/23 | 962 776 |
| 06/25 | 802 488 | 10/48 | 100 007 | 13/24 | 962 517 |
| 06/26 | 802 540 | 10/49 | 102 077 | 13/27 | 962 760 |
| 06/26 | 802 542 | 10/57 | 101 025 | 13/28 | 962 682 |
| 06/27 | 802 560 | 10/61 | 101 017 | 13/30 | 961 808 |
| 06/28 | 802 562 | 10/62 | 102 019 | 13/31 | 962 716 |
| 06/30 | 801 961 | 10/65 | 100 013 | 13/32 | 960 702 |
| 10/01 | 101 029 | 10/66 | 102 079 | 13/33 | 962 810 |
| 10/02 | 101 113 | 10/69 | 102 213 | 13/34 | 962 712 |
| 10/03 | 100 098 | 10/70 | 102 071 | 13/35 | 961 677 |
| 10/04 | 101 024 | 10/71 | 102 097 | 13/36 | 961 724 |
| 10/05 | 100 099 | 10/76 | 100 013 | 13/37 | 962 714 |
| 10/07 | 101 111 | 11/40 | 101 145 | 13/40 | 962 686 |
| 10/08 | 100 091 | 11/41 | 101 108 | 13/41 | 962 435 |
| 10/09 | 100 098 | 11/43 | 101 102 | 13/42 | 962 684 |
| 10/10 | 100 022 | 11/47 | 102 152 | 13/43 | 961 701 |
| 10/12 | 101 147 | 11/48 | 101 064 | 13/44 | 962 705 |
| 10/13 | 101 044 | 11/49 | 101 110 | 13/45 | 962 481 |
| 10/14 | 101 010 | 11/50 | 102 156 | 13/46 | 962 853 |
| 10/15 | 100 036 | 11/53 | 102 266 | 13/47 | 962 779 |
| 10/16 | 100 014 | 11/55 | 102 094 | 13/48 | 961 751 |
| 10/17 | 100 090 | 11/56 | 102 054 | 13/49 | 961 753 |
| 10/18 | 101 016 | 11/57 | 102 060 | 13/51 | 962 755 |
| 10/19 | 101 105 | 11/58 | 102 150 | 13/52 | 961 759 |
| 10/20 | 102 069 | 11/59 | 102 154 | 13/55 | 961 765 |
| 10/21 | 102 075 | 12/11 | 101 250 | 13/56 | 962 767 |
| 10/22 | 102 115 | 12/12 | 101 264 | 13/58 | 962 913 |
| 10/23 | 100 002 | 12/13 | 101 270 | 13/59 | 962 905 |
| 10/24 | 102 008 | 12/21 | 102 103 | 13/60 | 962 841 |
| 10/25 | 102 011 | 12/23 | 102 268 | 13/62 | 962 413 |
| 10/26 | 100 056 | 13/02 | 960 638 | 13/63 | 961 479 |
| 10/27 | 100 014 | 13/03 | 961 610 | 13/64 | 962 548 |
| 10/29 | 100 093 | 13/04 | 961 648 | 13/65 | 962 757 |

**VERGLEICHNUMMERNLISTE**
**CROSS REFERENCE GUIDE / LISTE DES ÉQUIVALENCES**

| HK    | OPTIMAL | HK    | OPTIMAL | HK    | OPTIMAL |
|-------|---------|-------|---------|-------|---------|
| 13/68 | 962 949 | 16/05 | 901 445 | 18/14 | 190 256 |
| 14/01 | 801 618 | 16/06 | 902 443 | 18/15 | 981 616 |
| 14/02 | 801 694 | 16/07 | 901 429 | 18/16 | 981 744 |
| 14/03 | 801 543 | 16/09 | 902 771 | 18/18 | 981 475 |
| 14/20 | 802 720 | 16/10 | 902 855 | 18/19 | 982 431 |
| 14/21 | 802 732 | 16/11 | 901 425 | 18/20 | 982 650 |
| 15/03 | 941 700 | 16/21 | 902 457 | 18/21 | 982 685 |
| 15/03 | 941 840 | 16/22 | 902 459 | 18/21 | 982 764 |
| 15/06 | 940 632 | 16/91 | 202 252 | 18/22 | 982 816 |
| 15/07 | 941 602 | 17/01 | 911 629 | 18/23 | 982 778 |
| 15/08 | 941 873 | 17/03 | 911 377 | 18/25 | 982 780 |
| 15/09 | 940 371 | 17/04 | 911 377 | 18/26 | 982 431 |
| 15/10 | 941 497 | 17/06 | 911 387 | 18/27 | 982 766 |
| 15/12 | 941 786 | 17/07 | 911 385 | 18/28 | 982 581 |
| 15/13 | 941 634 | 17/08 | 912 775 | 18/29 | 982 373 |
| 15/13 | 941 874 | 17/09 | 881 704 | 18/30 | 191 272 |
| 15/14 | 941 734 | 17/11 | 912 423 | 18/31 | 981 407 |
| 15/15 | 941 636 | 17/12 | 911 777 | 18/32 | 982 737 |
| 15/16 | 941 617 | 17/13 | 911 513 | 18/34 | 982 379 |
| 15/17 | 941 647 | 17/14 | 911 621 | 18/35 | 981 743 |
| 15/19 | 942 738 | 17/14 | 911 625 | 18/36 | 981 745 |
| 15/21 | 942 566 | 17/15 | 911 623 | 18/37 | 981 747 |
| 15/22 | 942 674 | 17/16 | 911 600 | 18/38 | 982 749 |
| 15/23 | 942 768 | 17/17 | 911 782 | 18/39 | 981 499 |
| 15/23 | 942 770 | 17/18 | 911 375 | 18/40 | 192 274 |
| 15/24 | 942 568 | 17/19 | 911 399 | 18/41 | 981 533 |
| 15/24 | 942 570 | 17/21 | 912 505 | 18/42 | 982 762 |
| 15/25 | 942 501 | 17/22 | 912 515 | 18/43 | 981 763 |
| 15/26 | 942 672 | 17/23 | 912 473 | 18/44 | 982 774 |
| 15/27 | 942 619 | 17/25 | 912 471 | 18/44 | 982 884 |
| 15/28 | 942 818 | 17/26 | 912 530 | 18/45 | 982 811 |
| 15/28 | 942 820 | 17/27 | 912 532 | 18/46 | 982 813 |
| 15/29 | 941 842 | 17/28 | 912 401 | 18/51 | 980 614 |
| 15/31 | 941 565 | 17/29 | 912 403 | 18/55 | 981 856 |
| 15/40 | 942 695 | 17/30 | 912 545 | 18/56 | 981 868 |
| 15/40 | 942 754 | 17/31 | 912 518 | 18/57 | 982 857 |
| 15/51 | 942 569 | 17/32 | 912 803 | 19/01 | 922 441 |
| 15/53 | 942 773 | 17/42 | 882 167 | 19/01 | 922 882 |
| 15/54 | 942 381 | 18/02 | 981 572 | 19/02 | 922 439 |
| 15/55 | 941 862 | 18/03 | 191 258 | 19/03 | 922 797 |
| 15/56 | 942 569 | 18/04 | 981 851 | 19/04 | 922 799 |
| 15/56 | 942 844 | 18/06 | 982 561 | 19/05 | 922 781 |
| 15/57 | 942 845 | 18/08 | 981 690 | 19/06 | 922 783 |
| 15/58 | 941 842 | 18/10 | 981 790 | 19/07 | 922 854 |
| 16/01 | 901 461 | 18/11 | 981 447 | 19/08 | 952 405 |
| 16/02 | 901 427 | 18/11 | 981 814 | 19/09 | 951 409 |
| 16/03 | 901 427 | 18/13 | 981 742 | 19/10 | 920 752 |

## VERGLEICHNUMMERNLISTE

### CROSS REFERENCE GUIDE / LISTE DES ÉQUIVALENCES

| HK    | OPTIMAL | HK    | OPTIMAL | HK    | OPTIMAL |
|-------|---------|-------|---------|-------|---------|
| 19/11 | 951 519 | 22/14 | 971 707 | 30/31 | 702 494 |
| 19/12 | 951 756 | 22/15 | 972 709 | 30/33 | 701 726 |
| 19/13 | 951 606 | 23/02 | 971 451 | 30/34 | 701 404 |
| 19/14 | 951 722 | 23/03 | 971 612 | 30/35 | 702 514 |
| 19/15 | 951 449 | 23/04 | 971 567 | 30/36 | 701 728 |
| 19/16 | 952 551 | 23/05 | 971 455 | 30/37 | 701 424 |
| 19/17 | 951 604 | 23/06 | 971 575 | 30/38 | 702 309 |
| 19/20 | 942 788 | 23/09 | 972 571 | 30/38 | 702 380 |
| 19/20 | 952 832 | 23/10 | 972 573 | 30/39 | 702 452 |
| 19/21 | 952 593 | 23/12 | 972 453 | 30/40 | 702 550 |
| 19/22 | 952 679 | 23/13 | 972 719 | 30/41 | 702 552 |
| 19/23 | 952 710 | 23/15 | 972 688 | 30/42 | 702 311 |
| 19/24 | 952 661 | 23/30 | 972 453 | 30/43 | 702 436 |
| 19/25 | 952 678 | 23/40 | 972 699 | 30/44 | 702 456 |
| 19/26 | 952 676 | 25/07 | 971 791 | 30/46 | 702 448 |
| 19/28 | 952 608 | 25/08 | 972 793 | 30/47 | 702 462 |
| 19/29 | 952 769 | 25/09 | 971 795 | 30/48 | 702 692 |
| 19/30 | 951 708 | 26/04 | 922 787 | 30/49 | 702 537 |
| 19/40 | 952 758 | 26/05 | 922 789 | 30/50 | 702 365 |
| 19/41 | 952 415 | 26/06 | 921 555 | 30/51 | 702 494 |
| 19/42 | 952 417 | 26/07 | 922 557 | 30/53 | 602 337 |
| 20/01 | 880 419 | 30/02 | 700 310 | 30/54 | 602 361 |
| 20/02 | 880 421 | 30/02 | 701 346 | 30/55 | 702 586 |
| 20/03 | 880 912 | 30/03 | 700 310 | 30/57 | 682 305 |
| 20/12 | 881 507 | 30/05 | 701 307 | 30/58 | 681 303 |
| 20/13 | 881 592 | 30/06 | 601 323 | 30/61 | 702 359 |
| 20/14 | 880 812 | 30/07 | 602 345 | 30/62 | 702 351 |
| 20/15 | 881 622 | 30/08 | 602 349 | 30/63 | 702 355 |
| 20/16 | 881 534 | 30/09 | 602 347 | 30/64 | 702 357 |
| 20/18 | 881 594 | 30/11 | 602 341 | 30/65 | 702 321 |
| 20/20 | 882 598 | 30/12 | 701 826 | 30/66 | 701 319 |
| 20/21 | 880 525 | 30/13 | 701 374 | 30/67 | 702 353 |
| 20/23 | 882 664 | 30/14 | 601 654 | 30/68 | 702 312 |
| 20/25 | 882 875 | 30/15 | 701 332 | 30/69 | 702 850 |
| 20/28 | 882 624 | 30/16 | 701 432 | 30/73 | 702 866 |
| 20/29 | 882 729 | 30/17 | 701 326 | 30/76 | 601 953 |
| 20/30 | 882 727 | 30/18 | 701 302 | 30/78 | 702 846 |
| 20/32 | 882 235 | 30/19 | 602 339 | 30/80 | 701 860 |
| 22/01 | 971 615 | 30/21 | 702 350 | 30/81 | 702 846 |
| 22/02 | 971 627 | 30/21 | 702 817 | 30/82 | 602 956 |
| 22/02 | 971 635 | 30/22 | 702 328 | 30/84 | 701 977 |
| 22/03 | 971 631 | 30/24 | 702 380 | 30/85 | 701 978 |
| 22/05 | 971 641 | 30/25 | 702 352 | 30/86 | 702 960 |
| 22/10 | 972 465 | 30/26 | 702 316 | 30/87 | 702 958 |
| 22/11 | 972 639 | 30/27 | 702 426 | 30/88 | 702 957 |
| 22/12 | 972 633 | 30/29 | 702 550 | 30/89 | 702 959 |
| 22/13 | 972 637 | 30/30 | 702 312 | 30/90 | 701 975 |



**VERGLEICHNUMMERNLISTE**
**CROSS REFERENCE GUIDE / LISTE DES ÉQUIVALENCES**

| HK    | OPTIMAL | HK    | OPTIMAL | HK    | OPTIMAL |
|-------|---------|-------|---------|-------|---------|
| 30/92 | 700 245 | 44/31 | 201 621 | 50/22 | 602 412 |
| 40/01 | 502 252 | 44/32 | 201 623 | 50/24 | 602 406 |
| 40/01 | 682 263 | 44/33 | 202 627 | 50/25 | 602 343 |
| 40/02 | 681 261 | 44/34 | 202 625 | 50/25 | 602 388 |
| 40/04 | 681 259 | 44/51 | 200 012 | 50/26 | 602 390 |
| 40/08 | 601 348 | 44/51 | 202 065 | 50/27 | 602 414 |
| 40/10 | 601 440 | 44/51 | 972 389 | 50/28 | 602 430 |
| 40/10 | 602 418 | 44/52 | 200 020 | 50/29 | 602 320 |
| 40/11 | 602 865 | 44/54 | 201 084 | 50/30 | 601 580 |
| 40/16 | 601 434 | 44/55 | 202 140 | 50/31 | 681 506 |
| 40/17 | 601 336 | 44/56 | 202 142 | 50/33 | 681 325 |
| 40/18 | 600 308 | 44/56 | 972 397 | 50/40 | 602 584 |
| 40/19 | 600 334 | 44/57 | 202 218 | 50/41 | 682 508 |
| 40/23 | 602 358 | 44/62 | 202 202 | 50/41 | 682 510 |
| 40/24 | 602 815 | 44/63 | 202 204 | 50/42 | 682 327 |
| 40/25 | 602 314 | 44/64 | 202 226 | 50/43 | 682 329 |
| 40/26 | 602 340 | 44/65 | 202 168 | 50/49 | 602 430 |
| 40/27 | 602 392 | 49/12 | 501 194 | 50/49 | 602 539 |
| 40/28 | 602 322 | 49/20 | 502 134 | 50/50 | 602 937 |
| 40/30 | 602 356 | 49/21 | 502 178 | 50/51 | 602 344 |
| 40/31 | 601 253 | 49/24 | 502 068 | 60/01 | 891 536 |
| 40/40 | 681 471 | 49/25 | 502 066 | 60/02 | 891 466 |
| 44/01 | 201 262 | 49/26 | 502 070 | 60/03 | 891 544 |
| 44/02 | 202 059 | 49/27 | 502 072 | 60/04 | 891 469 |
| 44/03 | 201 031 | 49/28 | 502 135 | 60/04 | 891 628 |
| 44/04 | 201 033 | 49/29 | 502 066 | 60/05 | 891 486 |
| 44/06 | 201 043 | 49/30 | 502 148 | 60/06 | 892 733 |
| 44/07 | 201 035 | 49/31 | 502 135 | 60/08 | 892 735 |
| 44/08 | 201 095 | 49/32 | 502 138 | 60/09 | 891 333 |
| 44/09 | 201 517 | 49/33 | 502 125 | 60/10 | 891 731 |
| 44/10 | 201 087 | 49/34 | 502 123 | 60/11 | 891 822 |
| 44/11 | 202 224 | 49/35 | 501 161 | 60/12 | 892 843 |
| 44/12 | 201 089 | 49/37 | 502 163 | 60/13 | 891 477 |
| 44/13 | 201 085 | 50/01 | 602 369 | 60/16 | 891 522 |
| 44/14 | 202 101 | 50/02 | 602 367 | 60/17 | 891 520 |
| 44/15 | 201 210 | 50/04 | 602 249 | 60/18 | 891 482 |
| 44/16 | 201 040 | 50/06 | 601 916 | 60/19 | 891 484 |
| 44/16 | 971 391 | 50/07 | 602 320 | 60/20 | 892 804 |
| 44/17 | 201 032 | 50/09 | 602 926 | 60/21 | 891 878 |
| 44/17 | 202 026 | 50/11 | 601 495 | 60/23 | 892 460 |
| 44/17 | 971 393 | 50/14 | 601 384 | 60/24 | 892 802 |
| 44/19 | 201 228 | 50/15 | 601 396 | 60/25 | 892 474 |
| 44/20 | 202 236 | 50/16 | 601 306 | 60/26 | 892 458 |
| 44/22 | 202 021 | 50/19 | 602 338 | 60/27 | 892 470 |
| 44/23 | 202 023 | 50/20 | 602 821 | 60/27 | 892 472 |
| 44/26 | 202 519 | 50/21 | 602 541 | 60/28 | 892 872 |
| 44/29 | 701 247 | 50/21 | 602 859 | 60/29 | 892 468 |

## VERGLEICHNUMMERNLISTE

### CROSS REFERENCE GUIDE / LISTE DES ÉQUIVALENCES

| HK    | OPTIMAL | HK    | OPTIMAL | HK    | OPTIMAL |
|-------|---------|-------|---------|-------|---------|
| 60/31 | 891 869 | 67/49 | 401 276 | 78/29 | 302 120 |
| 65/02 | 891 630 | 67/52 | 402 030 | 78/29 | 302 122 |
| 65/12 | 891 509 | 67/53 | 402 116 | 78/30 | 300 062 |
| 65/14 | 891 524 | 67/54 | 400 061 | 78/31 | 302 260 |
| 65/14 | 891 706 | 67/55 | 402 080 | 78/32 | 302 058 |
| 65/15 | 891 546 | 67/56 | 402 050 | 78/33 | 302 248 |
| 65/16 | 891 496 | 67/57 | 402 216 | 78/34 | 302 186 |
| 65/22 | 892 830 | 67/58 | 402 080 | 78/35 | 302 188 |
| 65/23 | 892 806 | 67/59 | 402 242 | 78/36 | 302 192 |
| 65/24 | 892 670 | 67/60 | 401 137 | 78/37 | 302 162 |
| 65/25 | 892 476 | 67/71 | 402 242 | 78/38 | 302 160 |
| 65/26 | 892 668 | 67/72 | 402 116 | 78/38 | 302 172 |
| 65/27 | 892 498 | 67/74 | 400 051 | 78/40 | 302 174 |
| 67/01 | 401 212 | 67/75 | 402 081 | 78/40 | 302 176 |
| 67/02 | 402 143 | 67/76 | 401 083 | 78/41 | 301 183 |
| 67/03 | 402 117 | 67/80 | 401 501 | 78/42 | 302 124 |
| 67/04 | 402 119 | 67/82 | 401 157 | 78/43 | 302 197 |
| 67/05 | 400 107 | 67/83 | 402 159 | 78/44 | 301 511 |
| 67/06 | 501 136 | 70/01 | 991 998 | 78/45 | 302 196 |
| 67/10 | 501 184 | 70/02 | 991 898 | 78/46 | 302 190 |
| 67/11 | 501 092 | 70/20 | 992 943 | 78/47 | 301 139 |
| 67/14 | 501 088 | 78/01 | 302 067 | 78/47 | 301 141 |
| 67/14 | 501 112 | 78/02 | 301 180 | 78/48 | 301 198 |
| 67/16 | 501 114 | 78/03 | 302 057 | 78/48 | 301 200 |
| 67/17 | 501 170 | 78/04 | 301 132 | 78/50 | 301 118 |
| 67/18 | 501 136 | 78/05 | 301 182 | 78/60 | 302 164 |
| 67/19 | 501 133 | 78/06 | 301 130 | 78/61 | 302 166 |
| 67/22 | 501 121 | 78/07 | 301 244 | 78/65 | 301 185 |
| 67/23 | 502 109 | 78/07 | 301 246 | 78/66 | 302 257 |
| 67/24 | 501 121 | 78/08 | 301 034 | 78/67 | 302 255 |
| 67/30 | 401 214 | 78/08 | 301 038 | 78/79 | 301 667 |
| 67/31 | 401 047 | 78/09 | 301 006 | 80/11 | 600 410 |
| 67/32 | 402 063 | 78/10 | 301 045 | 80/16 | 601 446 |
| 67/33 | 401 300 | 78/11 | 301 039 | 90/01 | 801 342 |
| 67/34 | 402 301 | 78/12 | 301 151 | 90/03 | 802 954 |
| 67/35 | 401 082 | 78/14 | 301 280 | 90/04 | 800 398 |
| 67/36 | 401 078 | 78/15 | 300 004 | 90/05 | 800 366 |
| 67/37 | 401 042 | 78/17 | 301 230 | 90/06 | 801 360 |
| 67/38 | 401 100 | 78/18 | 301 232 | 90/07 | 800 400 |
| 67/39 | 401 104 | 78/19 | 301 018 | 90/08 | 801 450 |
| 67/40 | 401 222 | 78/21 | 302 254 | 90/09 | 801 656 |
| 67/42 | 401 126 | 78/22 | 302 146 | 90/10 | 801 922 |
| 67/43 | 401 028 | 78/24 | 302 234 | 90/11 | 801 538 |
| 67/44 | 401 277 | 78/25 | 300 052 | 90/12 | 801 574 |
| 67/45 | 401 048 | 78/27 | 302 046 | 90/13 | 801 402 |
| 67/47 | 401 078 | 78/28 | 302 074 | 90/15 | 801 698 |
| 67/48 | 401 096 | 78/28 | 302 076 | 90/16 | 800 408 |



## VERGLEICHNUMMERNLISTE

### CROSS REFERENCE GUIDE / LISTE DES ÉQUIVALENCES

| KACO   | OPTIMAL | KACO   | OPTIMAL | KACO   | OPTIMAL |
|--------|---------|--------|---------|--------|---------|
| 2020.0 | 401 028 | 2073.2 | 962 703 | 3001.2 | 302 248 |
| 2020.1 | 401 028 | 2075.2 | 962 712 | 3002.2 | 302 058 |
| 2021.0 | 401 126 | 2076.1 | 961 648 | 3003.1 | 301 132 |
| 2021.1 | 401 126 | 2079.2 | 962 705 | 3004.2 | 302 240 |
| 2024.1 | 401 100 | 2080.2 | 962 714 | 3005.2 | 302 176 |
| 2025.1 | 401 104 | 2081.1 | 960 638 | 3006.2 | 302 174 |
| 2026.2 | 402 080 | 2108.1 | 801 342 | 3007.2 | 302 162 |
| 2027.2 | 402 080 | 2110.1 | 801 574 | 3008.2 | 302 058 |
| 2028.0 | 401 042 | 2111.1 | 801 402 | 3009.1 | 301 180 |
| 2028.1 | 401 042 | 2112.1 | 801 538 | 3011.2 | 302 160 |
| 2029.2 | 402 116 | 2114.1 | 800 408 | 3012.2 | 302 166 |
| 2030.0 | 402 050 | 2115.2 | 802 378 | 3015.1 | 300 052 |
| 2030.2 | 402 050 | 2116.1 | 801 922 | 3016.1 | 301 151 |
| 2031.1 | 401 214 | 2117.2 | 802 464 | 3017.1 | 300 062 |
| 2032.2 | 402 216 | 2118.2 | 802 330 | 3018.2 | 302 164 |
| 2033.1 | 401 137 | 2120.1 | 801 698 | 3019.1 | 301 280 |
| 2034.2 | 402 143 | 2121.2 | 802 480 | 3020.2 | 602 833 |
| 2035.1 | 401 078 | 2122.2 | 802 330 | 3021.2 | 300 004 |
| 2036.2 | 402 116 | 2123.1 | 801 342 | 3022.2 | 302 172 |
| 2037.1 | 401 082 | 2124.2 | 802 394 | 3023.2 | 302 254 |
| 2038.2 | 402 242 | 2125.1 | 801 360 | 3024.2 | 302 146 |
| 2039.2 | 402 242 | 2126.2 | 802 318 | 3025.1 | 301 118 |
| 2040.1 | 401 212 | 2127.1 | 801 450 | 3026.2 | 302 234 |
| 2045.2 | 962 760 | 2131.1 | 800 304 | 3027.1 | 301 230 |
| 2046.2 | 962 682 | 2132.1 | 800 400 | 3029.2 | 302 208 |
| 2047.1 | 961 883 | 2135.2 | 802 368 | 3030.1 | 301 006 |
| 2048.1 | 961 680 | 2136.2 | 802 370 | 3031.1 | 301 018 |
| 2049.1 | 961 792 | 2138.2 | 802 324 | 3032.1 | 301 034 |
| 2052.1 | 961 796 | 2140.1 | 800 366 | 3033.1 | 301 038 |
| 2053.1 | 961 503 | 2141.2 | 802 444 | 3034.2 | 302 074 |
| 2055.2 | 962 684 | 2142.1 | 801 382 | 3040.1 | 301 232 |
| 2056.1 | 962 718 | 2144.1 | 800 398 | 3042.1 | 301 244 |
| 2057.0 | 401 048 | 2145.1 | 801 376 | 3043.1 | 301 246 |
| 2057.1 | 401 048 | 2146.1 | 802 526 | 3044.2 | 302 120 |
| 2058.0 | 402 116 | 2147.1 | 801 364 | 3045.2 | 302 122 |
| 2058.2 | 402 116 | 2148.1 | 801 362 | 3046.1 | 301 130 |
| 2060.1 | 401 096 | 2149.1 | 800 398 | 3048.2 | 302 076 |
| 2061.2 | 962 517 | 2150.1 | 801 730 | 3049.2 | 302 046 |
| 2062.2 | 962 776 | 2992.1 | 301 200 | 3051.2 | 942 788 |
| 2063.1 | 961 576 | 2993.1 | 301 198 | 3052.1 | 941 497 |
| 2065.1 | 962 716 | 2994.2 | 302 190 | 3053.1 | 941 786 |
| 2066.2 | 960 702 | 2995.2 | 302 196 | 3054.1 | 941 636 |
| 2067.1 | 960 578 | 2996.2 | 302 192 | 3055.2 | 942 570 |
| 2068.1 | 961 610 | 2997.1 | 302 188 | 3056.2 | 942 501 |
| 2069.1 | 960 578 | 2998.2 | 302 186 | 3057.1 | 941 634 |
| 2070.2 | 962 548 | 2999.1 | 301 182 | 3058.2 | 942 674 |
| 2072.1 | 960 638 | 3000.2 | 302 260 | 3059.1 | 941 734 |

## VERGLEICHNUMMERNLISTE

### CROSS REFERENCE GUIDE / LISTE DES ÉQUIVALENCES

| KACO   | OPTIMAL | KACO   | OPTIMAL | KACO   | OPTIMAL |
|--------|---------|--------|---------|--------|---------|
| 3060.2 | 942 566 | 3207.1 | 951 606 | 4113.2 | 702 817 |
| 3061.2 | 942 568 | 3208.2 | 952 710 | 4116.1 | 700 310 |
| 3062.1 | 940 632 | 3209.1 | 951 604 | 4118.2 | 702 328 |
| 3063.1 | 941 602 | 3210.1 | 952 679 | 4119.2 | 702 316 |
| 3064.2 | 942 768 | 3211.1 | 960 578 | 4120.2 | 702 352 |
| 3065.2 | 942 770 | 3212.1 | 952 676 | 4122.1 | 701 302 |
| 3066.2 | 942 818 | 3213.2 | 951 604 | 4123.1 | 702 312 |
| 3067.2 | 942 820 | 3214.2 | 951 606 | 4123.2 | 702 312 |
| 3068.2 | 942 672 | 3215.1 | 952 608 | 4124.1 | 701 404 |
| 3069.2 | 942 619 | 3217.1 | 601 446 | 4125.1 | 701 332 |
| 3070.2 | 942 501 | 3300.1 | 601 521 | 4126.2 | 702 452 |
| 3071.1 | 941 617 | 3400.1 | 881 507 | 4127.1 | 701 326 |
| 3072.1 | 941 700 | 3401.1 | 880 525 | 4128.2 | 702 452 |
| 3073.2 | 942 569 | 3402.2 | 882 598 | 4129.1 | 701 432 |
| 3074.2 | 942 773 | 3403.2 | 882 819 | 4130.2 | 702 350 |
| 3077.1 | 941 784 | 3403.2 | 882 863 | 4131.2 | 702 550 |
| 3112.2 | 912 505 | 3405.1 | 881 622 | 4132.2 | 702 514 |
| 3113.1 | 911 513 | 3406.2 | 882 664 | 4133.2 | 702 494 |
| 3115.1 | 911 782 | 3407.1 | 881 534 | 4134.2 | 702 494 |
| 3116.2 | 912 515 | 3500.1 | 802 620 | 4135.2 | 702 426 |
| 3117.1 | 911 513 | 3501.1 | 801 372 | 4136.2 | 702 552 |
| 3118.1 | 911 375 | 3502.1 | 800 400 | 4137.1 | 702 312 |
| 3119.1 | 911 621 | 3503.2 | 802 368 | 4139.1 | 702 312 |
| 3120.1 | 911 600 | 3504.2 | 802 370 | 4142.1 | 701 302 |
| 3121.1 | 911 375 | 3700.1 | 881 564 | 4145.1 | 701 307 |
| 3122.1 | 911 375 | 3701.2 | 882 666 | 4146.2 | 702 309 |
| 3123.1 | 881 704 | 4011.1 | 201 084 | 4147.2 | 702 311 |
| 3125.2 | 912 530 | 4012.1 | 201 084 | 4148.2 | 702 311 |
| 3126.2 | 912 515 | 4014.2 | 202 252 | 4151.1 | 701 307 |
| 3127.2 | 912 532 | 4015.2 | 202 140 | 4202.1 | 981 790 |
| 3128.2 | 912 473 | 4016.2 | 202 168 | 4210.1 | 600 410 |
| 3129.1 | 911 623 | 4017.2 | 202 142 | 4217.1 | 601 446 |
| 3130.2 | 912 530 | 4018.2 | 202 026 | 4223.2 | 602 414 |
| 3132.2 | 912 471 | 4019.1 | 201 210 | 4301.1 | 601 654 |
| 3133.1 | 912 530 | 4021.1 | 200 020 | 4302.2 | 602 815 |
| 3136.1 | 912 775 | 4023.1 | 201 228 | 4304.2 | 602 541 |
| 3138.2 | 911 385 | 4024.2 | 202 218 | 4305.1 | 601 336 |
| 3139.1 | 911 387 | 4025.1 | 200 012 | 4306.2 | 602 430 |
| 3140.2 | 911 777 | 4026.2 | 202 202 | 4307.2 | 602 340 |
| 3141.1 | 912 545 | 4027.2 | 202 204 | 4308.1 | 601 306 |
| 3200.1 | 951 722 | 4028.1 | 201 032 | 4309.2 | 602 539 |
| 3201.1 | 920 752 | 4029.2 | 202 236 | 4311.2 | 602 412 |
| 3202.2 | 952 832 | 4031.1 | 201 040 | 4312.2 | 602 821 |
| 3203.2 | 952 593 | 4033.2 | 202 226 | 4313.2 | 602 406 |
| 3204.1 | 951 519 | 4110.1 | 701 374 | 4314.1 | 601 384 |
| 3205.1 | 951 756 | 4111.1 | 701 826 | 4315.1 | 601 396 |
| 3206.2 | 952 661 | 4112.1 | 702 328 | 4315.1 | 701 432 |

## VERGLEICHNUMMERNLISTE

### CROSS REFERENCE GUIDE / LISTE DES ÉQUIVALENCES

| KACO   | OPTIMAL | KACO   | OPTIMAL | KACO      | OPTIMAL        |
|--------|---------|--------|---------|-----------|----------------|
| 4316.1 | 601 495 | 4806.1 | 971 455 | 6009.2    | 892 802        |
| 4317.2 | 602 859 | 4809.2 | 972 699 | 6010.2    | 892 470        |
| 4318.2 | 602 320 | 4810.2 | 972 453 | 6011.1    | 891 484        |
| 4319.2 | 602 388 | 4812.1 | 972 573 | 6012.1    | 891 482        |
| 4320.2 | 602 390 | 5011.1 | 100 022 | 6013.1    | 891 466        |
| 4321.2 | 602 414 | 5015.2 | 100 002 | 6014.1    | 891 466        |
| 4322.2 | 602 338 | 5016.2 | 102 150 | 6015.2    | 892 472        |
| 4323.1 | 601 348 | 5019.1 | 101 145 | 6016.1    | 891 486        |
| 4325.2 | 602 344 | 5022.1 | 100 002 | 7000.1    | 880 812        |
| 4327.2 | 602 314 | 5023.2 | 102 266 | 7001.1    | 881 592        |
| 4400.1 | 981 535 | 5024.2 | 102 008 | 7002.1    | 881 594        |
| 4401.1 | 981 572 | 5028.2 | 102 094 | 7003.2    | 882 643        |
| 4402.1 | 981 790 | 5029.1 | 101 010 | 8000.1    | 971 627        |
| 4403.2 | 982 650 | 5030.1 | 100 014 | 8001.1    | 971 615        |
| 4404.2 | 982 764 | 5030.1 | 101 147 | 8002.2    | 972 465        |
| 4405.1 | 981 814 | 5031.1 | 101 064 | 8003.2    | 972 639        |
| 4407.1 | 981 742 | 5032.2 | 102 054 | 8004.1    | 971 631        |
| 4408.2 | 982 816 | 5033.2 | 100 022 | 8005.1    | 971 635        |
| 4409.2 | 982 778 | 5033.2 | 102 060 | 8006.1    | 971 641        |
| 4410.2 | 982 766 | 5034.1 | 101 016 | 8007.2    | 972 637        |
| 4411.1 | 981 744 | 5038.1 | 101 102 |           |                |
| 4412.2 | 982 373 | 5039.1 | 101 110 | <b>QH</b> | <b>OPTIMAL</b> |
| 4413.2 | 982 780 | 5041.1 | 101 108 | QWB 104C  | 882 819        |
| 4415.1 | 190 256 | 5042.1 | 191 272 | QWB 110C  | 601 521        |
| 4416.1 | 981 690 | 5044.2 | 192 274 | QWB 113C  | 300 052        |
| 4417.1 | 981 447 | 5046.1 | 101 128 | QWB 114C  | 301 151        |
| 4509.1 | 101 270 | 5047.2 | 100 206 | QWB 115C  | 301 280        |
| 4510.2 | 102 268 | 5049.1 | 101 024 | QWB 122C  | 881 871        |
| 4511.1 | 101 264 | 5050.2 | 102 152 | QWB 126C  | 881 527        |
| 4512.1 | 101 250 | 5051.2 | 102 154 | QWB 129C  | 881 529        |
| 4602.1 | 891 509 | 5052.0 | 100 022 | QWB 133C  | 882 861        |
| 4603.1 | 891 524 | 5053.2 | 102 156 | QWB 137C  | 882 666        |
| 4604.1 | 891 706 | 5054.1 | 101 016 | QWB 140C  | 302 234        |
| 4605.1 | 891 546 | 5055.1 | 131 129 | QWB 142C  | 602 881        |
| 4608.2 | 892 830 | 5056.2 | 132 131 | QWB 143C  | 602 833        |
| 4609.2 | 892 806 | 5100.1 | 801 656 | QWB 148C  | 602 833        |
| 4610.2 | 892 670 | 5101.2 | 802 454 | QWB 151C  | 302 254        |
| 4611.2 | 892 476 | 5102.2 | 802 590 | QWB 152C  | 302 146        |
| 4612.2 | 892 668 | 5103.1 | 801 442 | QWB 154C  | 602 833        |
| 4613.1 | 891 496 | 5104.2 | 802 658 | QWB 155C  | 200 012        |
| 4614.2 | 892 498 | 5200.1 | 801 354 | QWB 157C  | 881 523        |
| 4700.1 | 801 618 | 6001.2 | 892 468 | QWB 158C  | 301 232        |
| 4701.2 | 802 720 | 6002.1 | 891 520 | QWB 159C  | 881 592        |
| 4703.2 | 802 732 | 6003.1 | 891 522 | QWB 163C  | 882 531        |
| 4801.1 | 971 451 | 6004.2 | 892 460 | QWB 167C  | 882 863        |
| 4802.2 | 972 573 | 6005.2 | 892 474 | QWB 170C  | 881 523        |
| 4805.1 | 972 453 | 6006.2 | 892 458 | QWB 177C  | 202 236        |
|        |         |        |         | QWB 180C  | 302 162        |

**VERGLEICHNUMMERNLISTE**
**CROSS REFERENCE GUIDE / LISTE DES ÉQUIVALENCES**

| QH       | OPTIMAL | QH      | OPTIMAL | QH      | OPTIMAL |
|----------|---------|---------|---------|---------|---------|
| QWB 184C | 301 230 | QWB 291 | 602 406 | QWB 436 | 201 032 |
| QWB 186C | 880 812 | QWB 292 | 602 412 | QWB 436 | 202 026 |
| QWB 187C | 880 812 | QWB 302 | 701 374 | QWB 436 | 502 068 |
| QWB 191C | 880 525 | QWB 309 | 701 432 | QWB 440 | 882 875 |
| QWB 192C | 880 525 | QWB 310 | 702 328 | QWB 441 | 802 646 |
| QWB 193C | 302 160 | QWB 313 | 701 332 | QWB 444 | 981 447 |
| QWB 194C | 302 172 | QWB 326 | 891 509 | QWB 444 | 981 814 |
| QWB 197C | 881 564 | QWB 328 | 101 010 | QWB 445 | 602 859 |
| QWB 199C | 681 919 | QWB 333 | 102 266 | QWB 446 | 602 541 |
| QWB 200  | 101 044 | QWB 337 | 892 460 | QWB 448 | 602 821 |
| QWB 201  | 100 002 | QWB 344 | 961 724 | QWB 449 | 941 786 |
| QWB 203  | 502 134 | QWB 347 | 961 503 | QWB 449 | 941 873 |
| QWB 209  | 100 002 | QWB 349 | 962 517 | QWB 450 | 602 358 |
| QWB 210  | 801 588 | QWB 354 | 962 684 | QWB 451 | 602 392 |
| QWB 211  | 802 652 | QWB 354 | 962 949 | QWB 454 | 601 828 |
| QWB 213  | 802 556 | QWB 355 | 961 796 | QWB 455 | 602 416 |
| QWB 213  | 802 558 | QWB 356 | 192 274 | QWB 456 | 892 830 |
| QWB 214  | 801 238 | QWB 360 | 982 764 | QWB 458 | 601 502 |
| QWB 216  | 501 194 | QWB 360 | 982 945 | QWB 459 | 602 414 |
| QWB 217  | 501 184 | QWB 361 | 981 535 | QWB 461 | 602 390 |
| QWB 218  | 502 178 | QWB 365 | 981 798 | QWB 462 | 911 621 |
| QWB 224  | 600 410 | QWB 366 | 981 790 | QWB 465 | 891 522 |
| QWB 227  | 601 440 | QWB 367 | 982 650 | QWB 467 | 701 326 |
| QWB 228  | 602 418 | QWB 375 | 920 752 | QWB 469 | 941 634 |
| QWB 229  | 602 865 | QWB 381 | 892 804 | QWB 470 | 942 674 |
| QWB 231  | 601 446 | QWB 389 | 101 145 | QWB 474 | 701 726 |
| QWB 235  | 942 788 | QWB 406 | 102 094 | QWB 475 | 702 436 |
| QWB 238  | 802 480 | QWB 407 | 101 064 | QWB 476 | 602 584 |
| QWB 239  | 801 574 | QWB 414 | 300 062 | QWB 478 | 601 580 |
| QWB 240  | 801 922 | QWB 416 | 300 004 | QWB 479 | 701 404 |
| QWB 241  | 802 464 | QWB 417 | 201 040 | QWB 480 | 702 462 |
| QWB 242  | 801 402 | QWB 418 | 301 006 | QWB 481 | 681 504 |
| QWB 243  | 800 408 | QWB 419 | 880 812 | QWB 482 | 682 642 |
| QWB 247  | 801 698 | QWB 420 | 301 018 | QWB 483 | 682 420 |
| QWB 249  | 801 538 | QWB 421 | 802 318 | QWB 486 | 681 640 |
| QWB 254  | 802 454 | QWB 422 | 800 304 | QWB 487 | 601 306 |
| QWB 255  | 401 028 | QWB 422 | 800 366 | QWB 488 | 602 340 |
| QWB 256  | 401 222 | QWB 422 | 801 354 | QWB 489 | 601 336 |
| QWB 259  | 402 030 | QWB 424 | 912 515 | QWB 490 | 911 600 |
| QWB 260  | 802 620 | QWB 425 | 881 507 | QWB 491 | 601 434 |
| QWB 264  | 912 505 | QWB 426 | 911 513 | QWB 492 | 962 776 |
| QWB 272  | 602 815 | QWB 427 | 881 879 | QWB 493 | 801 618 |
| QWB 280  | 202 204 | QWB 429 | 102 008 | QWB 494 | 102 152 |
| QWB 281  | 202 202 | QWB 430 | 701 302 | QWB 495 | 202 226 |
| QWB 283  | 202 252 | QWB 430 | 701 346 | QWB 496 | 102 060 |
| QWB 286  | 701 826 | QWB 431 | 702 312 | QWB 497 | 702 456 |
| QWB 289  | 601 384 | QWB 435 | 882 664 | QWB 498 | 701 424 |

## VERGLEICHNUMMERNLISTE

### CROSS REFERENCE GUIDE / LISTE DES ÉQUIVALENCES

| QH      | OPTIMAL | QH      | OPTIMAL | QH      | OPTIMAL |
|---------|---------|---------|---------|---------|---------|
| QWB 499 | 882 643 | QWB 558 | 891 520 | QWB 618 | 912 530 |
| QWB 500 | 602 340 | QWB 560 | 702 426 | QWB 619 | 941 734 |
| QWB 501 | 601 336 | QWB 562 | 881 622 | QWB 620 | 952 679 |
| QWB 503 | 602 320 | QWB 563 | 702 380 | QWB 621 | 982 780 |
| QWB 507 | 601 495 | QWB 564 | 700 310 | QWB 622 | 982 766 |
| QWB 508 | 401 048 | QWB 565 | 702 550 | QWB 623 | 981 616 |
| QWB 509 | 802 394 | QWB 566 | 702 316 | QWB 625 | 981 790 |
| QWB 510 | 100 014 | QWB 567 | 302 046 | QWB 628 | 941 565 |
| QWB 510 | 101 147 | QWB 568 | 301 038 | QWB 629 | 702 350 |
| QWB 511 | 100 036 | QWB 569 | 301 034 | QWB 629 | 702 817 |
| QWB 512 | 101 016 | QWB 570 | 202 168 | QWB 630 | 601 396 |
| QWB 513 | 502 070 | QWB 574 | 802 368 | QWB 630 | 601 654 |
| QWB 514 | 502 066 | QWB 575 | 802 370 | QWB 632 | 302 174 |
| QWB 515 | 801 342 | QWB 576 | 501 088 | QWB 633 | 302 176 |
| QWB 516 | 891 822 | QWB 578 | 190 256 | QWB 634 | 600 334 |
| QWB 517 | 501 092 | QWB 579 | 961 808 | QWB 635 | 602 322 |
| QWB 519 | 880 419 | QWB 580 | 901 461 | QWB 636 | 981 572 |
| QWB 519 | 880 812 | QWB 581 | 962 760 | QWB 637 | 982 778 |
| QWB 520 | 501 114 | QWB 582 | 962 760 | QWB 638 | 920 752 |
| QWB 521 | 101 108 | QWB 585 | 681 919 | QWB 640 | 902 459 |
| QWB 522 | 101 102 | QWB 586 | 681 907 | QWB 641 | 902 457 |
| QWB 524 | 602 340 | QWB 589 | 602 340 | QWB 642 | 882 613 |
| QWB 525 | 600 308 | QWB 590 | 202 065 | QWB 643 | 882 611 |
| QWB 527 | 302 074 | QWB 591 | 912 471 | QWB 644 | 881 609 |
| QWB 528 | 302 076 | QWB 592 | 912 530 | QWB 645 | 952 593 |
| QWB 530 | 301 244 | QWB 593 | 302 208 | QWB 647 | 802 720 |
| QWB 531 | 301 246 | QWB 594 | 881 534 | QWB 648 | 701 728 |
| QWB 532 | 302 120 | QWB 596 | 200 020 | QWB 649 | 702 448 |
| QWB 533 | 302 122 | QWB 597 | 982 816 | QWB 650 | 602 430 |
| QWB 534 | 501 112 | QWB 598 | 891 706 | QWB 650 | 682 490 |
| QWB 535 | 912 515 | QWB 599 | 892 458 | QWB 650 | 682 492 |
| QWB 536 | 402 116 | QWB 600 | 962 686 | QWB 651 | 892 474 |
| QWB 537 | 501 114 | QWB 601 | 941 511 | QWB 654 | 401 042 |
| QWB 538 | 961 680 | QWB 602 | 942 566 | QWB 655 | 892 802 |
| QWB 539 | 962 682 | QWB 603 | 201 084 | QWB 656 | 961 765 |
| QWB 541 | 882 531 | QWB 604 | 801 478 | QWB 656 | 962 847 |
| QWB 543 | 301 130 | QWB 605 | 802 652 | QWB 658 | 962 435 |
| QWB 544 | 101 110 | QWB 607 | 682 920 | QWB 659 | 401 126 |
| QWB 545 | 682 422 | QWB 608 | 702 692 | QWB 661 | 881 594 |
| QWB 546 | 102 054 | QWB 610 | 602 430 | QWB 662 | 702 352 |
| QWB 551 | 801 372 | QWB 611 | 601 384 | QWB 663 | 891 546 |
| QWB 551 | 802 620 | QWB 612 | 682 921 | QWB 664 | 892 670 |
| QWB 552 | 941 497 | QWB 613 | 682 920 | QWB 665 | 892 668 |
| QWB 554 | 602 539 | QWB 614 | 961 883 | QWB 666 | 801 644 |
| QWB 555 | 922 439 | QWB 615 | 892 804 | QWB 666 | 801 750 |
| QWB 556 | 962 776 | QWB 616 | 911 600 | QWB 671 | 802 540 |
| QWB 557 | 961 576 | QWB 617 | 901 445 | QWB 672 | 802 542 |



**VERGLEICHNUMMERNLISTE**
**CROSS REFERENCE GUIDE / LISTE DES ÉQUIVALENCES**

| QH      | OPTIMAL | QH      | OPTIMAL | QH      | OPTIMAL |
|---------|---------|---------|---------|---------|---------|
| QWB 673 | 802 324 | QWB 723 | 942 568 | QWB 782 | 602 320 |
| QWB 674 | 801 360 | QWB 724 | 942 570 | QWB 785 | 972 688 |
| QWB 676 | 801 442 | QWB 725 | 801 656 | QWB 786 | 501 136 |
| QWB 677 | 802 658 | QWB 726 | 892 470 | QWB 787 | 502 138 |
| QWB 678 | 602 388 | QWB 727 | 942 754 | QWB 789 | 201 040 |
| QWB 679 | 602 338 | QWB 727 | 960 702 | QWB 790 | 602 344 |
| QWB 680 | 702 452 | QWB 730 | 942 754 | QWB 791 | 602 430 |
| QWB 681 | 702 514 | QWB 731 | 962 762 | QWB 792 | 801 382 |
| QWB 682 | 801 450 | QWB 732 | 962 760 | QWB 794 | 801 376 |
| QWB 683 | 100 090 | QWB 733 | 100 098 | QWB 795 | 800 398 |
| QWB 684 | 501 170 | QWB 733 | 100 099 | QWB 796 | 100 002 |
| QWB 685 | 802 748 | QWB 734 | 802 378 | QWB 797 | 102 008 |
| QWB 686 | 302 240 | QWB 735 | 800 400 | QWB 798 | 601 306 |
| QWB 687 | 702 552 | QWB 736 | 802 330 | QWB 799 | 602 320 |
| QWB 688 | 892 476 | QWB 737 | 601 582 | QWB 800 | 802 488 |
| QWB 689 | 891 524 | QWB 738 | 602 512 | QWB 800 | 802 528 |
| QWB 690 | 891 482 | QWB 739 | 682 508 | QWB 803 | 952 710 |
| QWB 691 | 801 554 | QWB 740 | 682 510 | QWB 804 | 882 624 |
| QWB 692 | 951 708 | QWB 742 | 912 532 | QWB 805 | 912 532 |
| QWB 693 | 191 272 | QWB 743 | 881 704 | QWB 806 | 931 877 |
| QWB 694 | 192 274 | QWB 745 | 942 672 | QWB 809 | 942 818 |
| QWB 695 | 951 756 | QWB 746 | 951 606 | QWB 810 | 942 820 |
| QWB 696 | 301 180 | QWB 747 | 952 661 | QWB 811 | 801 543 |
| QWB 697 | 302 058 | QWB 748 | 952 758 | QWB 811 | 801 694 |
| QWB 698 | 100 022 | QWB 751 | 102 150 | QWB 812 | 971 612 |
| QWB 699 | 942 768 | QWB 752 | 401 137 | QWB 813 | 402 050 |
| QWB 700 | 942 770 | QWB 752 | 402 050 | QWB 814 | 972 465 |
| QWB 701 | 881 489 | QWB 754 | 402 080 | QWB 815 | 961 904 |
| QWB 702 | 981 572 | QWB 756 | 302 124 | QWB 816 | 962 899 |
| QWB 703 | 982 766 | QWB 758 | 401 096 | QWB 816 | 962 905 |
| QWB 704 | 982 780 | QWB 759 | 891 484 | QWB 817 | 301 132 |
| QWB 705 | 981 814 | QWB 760 | 802 740 | QWB 819 | 881 704 |
| QWB 706 | 880 419 | QWB 762 | 942 738 | QWB 820 | 911 625 |
| QWB 706 | 880 421 | QWB 763 | 962 718 | QWB 821 | 911 782 |
| QWB 707 | 802 732 | QWB 764 | 962 716 | QWB 822 | 802 590 |
| QWB 708 | 882 491 | QWB 766 | 981 616 | QWB 823 | 100 022 |
| QWB 709 | 932 794 | QWB 767 | 981 744 | QWB 824 | 600 334 |
| QWB 710 | 972 633 | QWB 768 | 981 742 | QWB 825 | 602 322 |
| QWB 711 | 922 799 | QWB 769 | 401 104 | QWB 827 | 101 044 |
| QWB 712 | 911 623 | QWB 773 | 401 100 | QWB 828 | 681 506 |
| QWB 713 | 922 797 | QWB 774 | 802 562 | QWB 829 | 602 344 |
| QWB 714 | 971 615 | QWB 775 | 601 348 | QWB 830 | 602 338 |
| QWB 716 | 951 722 | QWB 776 | 602 356 | QWB 831 | 502 148 |
| QWB 717 | 941 617 | QWB 778 | 502 158 | QWB 832 | 201 032 |
| QWB 720 | 100 056 | QWB 779 | 502 072 | QWB 833 | 600 334 |
| QWB 721 | 940 632 | QWB 780 | 941 602 | QWB 835 | 600 308 |
| QWB 722 | 941 636 | QWB 781 | 600 308 | QWB 836 | 882 626 |

## VERGLEICHNUMMERNLISTE

### CROSS REFERENCE GUIDE / LISTE DES ÉQUIVALENCES

| QH      | OPTIMAL | QH      | OPTIMAL | QH       | OPTIMAL |
|---------|---------|---------|---------|----------|---------|
| QWB 839 | 602 314 | QWB 887 | 911 383 | QWB 944  | 800 398 |
| QWB 840 | 302 260 | QWB 889 | 940 371 | QWB 944  | 801 428 |
| QWB 841 | 911 629 | QWB 890 | 941 700 | QWB 945  | 100 098 |
| QWB 842 | 952 608 | QWB 891 | 941 700 | QWB 948  | 201 262 |
| QWB 843 | 912 530 | QWB 891 | 942 569 | QWB 950  | 700 310 |
| QWB 844 | 802 444 | QWB 892 | 991 902 | QWB 950  | 701 307 |
| QWB 845 | 100 090 | QWB 893 | 992 894 | QWB 951  | 702 357 |
| QWB 846 | 801 500 | QWB 896 | 971 455 | QWB 951  | 702 426 |
| QWB 847 | 981 616 | QWB 897 | 982 379 | QWB 952  | 702 355 |
| QWB 848 | 800 400 | QWB 898 | 982 431 | QWB 952  | 702 426 |
| QWB 849 | 892 498 | QWB 899 | 981 475 | QWB 953  | 702 309 |
| QWB 850 | 912 530 | QWB 900 | 981 475 | QWB 954  | 702 313 |
| QWB 851 | 942 672 | QWB 900 | 981 944 | QWB 955  | 100 090 |
| QWB 852 | 302 248 | QWB 901 | 802 560 | QWB 956  | 960 638 |
| QWB 853 | 800 398 | QWB 902 | 802 368 | QWB 956  | 961 701 |
| QWB 853 | 801 730 | QWB 903 | 201 084 | QWB 957  | 951 604 |
| QWB 854 | 801 364 | QWB 904 | 972 573 | QWB 958  | 951 604 |
| QWB 855 | 801 362 | QWB 906 | 502 068 | QWB 962  | 971 567 |
| QWB 856 | 802 370 | QWB 907 | 702 426 | QWB 963  | 201 262 |
| QWB 857 | 600 308 | QWB 908 | 602 314 | QWB 964  | 802 315 |
| QWB 858 | 602 341 | QWB 909 | 912 532 | QWB 965  | 911 385 |
| QWB 858 | 602 388 | QWB 910 | 882 598 | QWB 966  | 911 387 |
| QWB 859 | 301 182 | QWB 911 | 882 463 | QWB 966  | 912 775 |
| QWB 860 | 302 186 | QWB 912 | 301 198 | QWB 967  | 912 518 |
| QWB 861 | 302 192 | QWB 913 | 301 200 | QWB 971  | 892 472 |
| QWB 862 | 302 188 | QWB 915 | 971 451 | QWB 973  | 882 729 |
| QWB 863 | 301 118 | QWB 916 | 972 709 | QWB 974  | 681 303 |
| QWB 864 | 302 164 | QWB 917 | 911 375 | QWB 977  | 971 627 |
| QWB 865 | 302 166 | QWB 918 | 942 672 | QWB 978  | 982 737 |
| QWB 866 | 302 196 | QWB 921 | 942 773 | QWB 984  | 952 405 |
| QWB 867 | 302 190 | QWB 922 | 962 779 | QWB 988  | 952 415 |
| QWB 870 | 602 320 | QWB 922 | 962 853 | QWB 989  | 952 415 |
| QWB 871 | 701 307 | QWB 924 | 901 429 | QWB 991  | 101 270 |
| QWB 872 | 702 311 | QWB 926 | 952 608 | QWB 992  | 101 264 |
| QWB 874 | 702 365 | QWB 928 | 961 648 | QWB 993  | 101 250 |
| QWB 876 | 202 140 | QWB 930 | 602 343 | QWB 995  | 682 329 |
| QWB 877 | 202 142 | QWB 931 | 960 578 | QWB 996  | 682 327 |
| QWB 878 | 201 228 | QWB 932 | 101 105 | QWB 997  | 100 206 |
| QWB 878 | 891 630 | QWB 932 | 602 388 | QWB 997  | 101 128 |
| QWB 879 | 202 218 | QWB 933 | 962 703 | QWB 997  | 101 209 |
| QWB 880 | 101 024 | QWB 934 | 981 690 | QWB 999  | 951 606 |
| QWB 881 | 891 520 | QWB 935 | 201 210 | QWB 1000 | 132 131 |
| QWB 882 | 892 468 | QWB 938 | 961 610 | QWB 1001 | 682 305 |
| QWB 883 | 892 733 | QWB 939 | 962 548 | QWB 1005 | 681 325 |
| QWB 883 | 982 379 | QWB 940 | 942 619 | QWB 1023 | 911 399 |
| QWB 884 | 901 425 | QWB 942 | 702 586 | QWB 1039 | 891 628 |
| QWB 886 | 911 375 | QWB 943 | 971 707 | QWB 1039 | 892 735 |

**VERGLEICHNUMMERNLISTE**
**CROSS REFERENCE GUIDE / LISTE DES ÉQUIVALENCES**

| QH       | OPTIMAL | QH       | OPTIMAL | RUL - SNR | OPTIMAL |
|----------|---------|----------|---------|-----------|---------|
| QWB 1048 | 702 537 | QWB 1123 | 981 952 | KF155.73  | 702 603 |
| QWB 1049 | 602 337 | QWB 1124 | 882 487 | KF155.81S | 702 976 |
| QWB 1050 | 602 339 | QWB 1125 | 302 058 | R140.02   | 681 640 |
| QWB 1051 | 602 367 | QWB 1126 | 301 039 | R140.03   | 682 642 |
| QWB 1052 | 982 857 | QWB 1127 | 301 045 | R140.18   | 601 580 |
| QWB 1053 | 982 561 | QWB 1128 | 302 057 | R140.19   | 602 584 |
| QWB 1054 | 682 911 | QWB 1129 | 981 947 | R140.23   | 701 726 |
| QWB 1055 | 102 115 | QWB 1131 | 702 321 | R140.24   | 702 436 |
| QWB 1057 | 400 107 | QWB 1132 | 702 866 | R140.25   | 702 456 |
| QWB 1066 | 912 401 | QWB 1133 | 702 494 | R140.26   | 191 272 |
| QWB 1066 | 912 403 | QWB 1136 | 962 712 | R140.27   | 192 274 |
| QWB 1068 | 401 047 | QWB 1137 | 102 011 | R140.29   | 801 746 |
| QWB 1069 | 402 063 | QWB 1160 | 102 069 | R140.30   | 941 511 |
| QWB 1070 | 401 078 | QWB 1165 | 912 804 | R140.31   | 942 754 |
| QWB 1071 | 802 485 | QWB 1172 | 991 655 | R140.32   | 802 662 |
| QWB 1072 | 952 678 | QWB 1173 | 991 657 | R140.33   | 802 660 |
| QWB 1073 | 952 676 | QWB 1174 | 991 749 | R140.34   | 951 708 |
| QWB 1079 | 922 783 | QWB 1175 | 992 659 | R140.35   | 952 758 |
| QWB 1081 | 922 781 | QWB 1176 | 992 663 | R140.38   | 681 471 |
| QWB 1082 | 302 058 | QWB 1177 | 992 922 | R140.39   | 961 808 |
| QWB 1083 | 701 852 | QWB 1178 | 992 689 | R140.41   | 962 686 |
| QWB 1084 | 700 310 | QWB 1211 | 201 095 | R140.42   | 681 504 |
| QWB 1085 | 701 860 | QWB 1228 | 602 956 | R140.43   | 682 420 |
| QWB 1086 | 702 846 | QWB 1257 | 102 075 | R140.44   | 682 422 |
| QWB 1087 | 701 319 | QWB 1259 | 302 255 | R140.46   | 702 462 |
| QWB 1088 | 702 312 | QWB 1260 | 302 257 | R140.47   | 702 448 |
| QWB 1089 | 101 113 | QWB 1268 | 501 161 | R140.52   | 302 172 |
| QWB 1091 | 702 359 | QWB 1269 | 502 163 | R140.53   | 302 160 |
| QWB 1092 | 702 850 | QWB 1277 | 702 957 | R140.54   | 961 808 |
| QWB 1094 | 912 803 | QWB 1278 | 911 802 | R140.55   | 962 686 |
| QWB 1095 | 102 115 | QWB 1283 | 102 079 | R140.56   | 702 692 |
| QWB 1096 | 701 914 | QWB 1288 | 401 300 | R140.57   | 701 728 |
| QWB 1097 | 801 838 | QWB 1289 | 402 301 | R140.58   | 801 750 |
| QWB 1098 | 801 950 | QWB 1293 | 301 767 | R140.59   | 801 644 |
| QWB 1101 | 802 839 | QWB 1307 | 201 621 | R140.65   | 802 748 |
| QWB 1102 | 801 836 | QWB 1308 | 201 623 | R140.66   | 802 740 |
| QWB 1110 | 301 139 | QWB 1309 | 202 625 | R140.67   | 302 240 |
| QWB 1111 | 301 141 | QWB 1310 | 202 627 | R140.68   | 302 162 |
| QWB 1112 | 201 033 | QWB 1313 | 701 247 | R140.69   | 302 174 |
| QWB 1113 | 201 035 | QWB 1319 | 102 071 | R140.70   | 302 176 |
| QWB 1114 | 201 043 | QWB 1320 | 801 961 | R140.72   | 401 214 |
| QWB 1115 | 202 059 | QWB 1321 | 802 271 | R140.73   | 402 216 |
| QWB 1116 | 880 912 | QWB 1326 | 102 213 | R140.76   | 401 137 |
| QWB 1117 | 201 031 | QWB 1332 | 702 983 | R140.77   | 681 506 |
| QWB 1118 | 801 500 | QWB 1333 | 681 259 | R140.78   | 682 508 |
| QWB 1119 | 891 536 | QWB 1334 | 801 267 | R140.79   | 682 510 |
| QWB 1120 | 891 466 | QWB 1339 | 402 827 | R140.80   | 302 124 |

## VERGLEICHNUMMERNLISTE

### CROSS REFERENCE GUIDE / LISTE DES ÉQUIVALENCES

| RUL - SNR | OPTIMAL | RUL - SNR | OPTIMAL | RUL - SNR | OPTIMAL |
|-----------|---------|-----------|---------|-----------|---------|
| R140.81   | 702 586 | R151.09   | 401 104 | R152.34   | 302 076 |
| R140.82   | 941 565 | R151.10   | 402 050 | R152.35   | 301 130 |
| R140.83   | 682 492 | R151.11   | 401 100 | R152.36   | 301 180 |
| R140.84   | 682 490 | R151.12   | 401 126 | R152.37   | 302 058 |
| R140.85   | 302 166 | R151.13   | 402 116 | R152.39   | 301 132 |
| R140.86   | 302 164 | R151.14   | 401 042 | R152.40   | 302 248 |
| R140.87   | 301 118 | R151.15   | 402 080 | R152.41   | 302 260 |
| R140.88   | 402 143 | R151.16   | 402 080 | R152.42   | 301 182 |
| R140.90   | 961 677 | R151.17   | 401 096 | R152.43   | 302 186 |
| R140.91   | 962 435 | R151.18   | 401 078 | R152.44   | 302 188 |
| R140.92   | 961 724 | R151.19   | 402 116 | R152.45   | 302 192 |
| R140.94   | 681 325 | R151.20   | 401 082 | R152.46   | 302 196 |
| R140.95   | 682 327 | R151.21   | 402 242 | R152.47   | 302 190 |
| R140.96   | 682 329 | R151.22   | 402 242 | R152.48   | 301 198 |
| R150.00   | 501 184 | R151.23   | 401 212 | R152.49   | 301 200 |
| R150.02   | 501 194 | R151.24   | 401 078 | R152.50   | 301 139 |
| R150.03   | 502 134 | R151.26   | 400 051 | R152.51   | 301 141 |
| R150.07   | 502 178 | R151.27   | 400 107 | R152.52   | 302 067 |
| R150.09   | 501 092 | R151.31   | 401 047 | R152.53   | 302 037 |
| R150.10   | 502 070 | R151.32   | 402 063 | R152.54   | 301 039 |
| R150.11   | 501 114 | R151.33   | 400 061 | R152.55   | 301 045 |
| R150.12   | 502 066 | R151.35   | 401 083 | R152.56   | 302 057 |
| R150.14   | 502 158 | R151.36   | 401 157 | R152.58   | 302 255 |
| R150.15   | 501 088 | R151.38   | 401 501 | R152.59   | 302 257 |
| R150.16   | 502 068 | R151.41   | 402 159 | R152.60   | 301 185 |
| R150.17   | 501 088 | R152.02   | 300 062 | R152.61   | 301 511 |
| R150.17   | 501 112 | R152.05   | 301 151 | R152.62   | 301 667 |
| R150.19   | 502 072 | R152.06   | 602 833 | R153.06   | 202 252 |
| R150.20   | 501 170 | R152.08   | 301 280 | R153.07   | 200 012 |
| R150.22   | 501 136 | R152.09   | 302 254 | R153.07   | 972 389 |
| R150.23   | 502 138 | R152.10   | 302 146 | R153.08   | 202 202 |
| R150.24   | 502 148 | R152.12   | 300 052 | R153.09   | 202 204 |
| R150.26   | 501 133 | R152.13   | 302 234 | R153.10   | 202 236 |
| R150.27   | 502 135 | R152.16   | 301 018 | R153.13   | 202 226 |
| R150.28   | 502 125 | R152.17   | 300 004 | R153.14   | 201 040 |
| R150.29   | 502 123 | R152.18   | 301 232 | R153.14   | 971 391 |
| R150.30   | 501 121 | R152.19   | 301 006 | R153.15   | 201 032 |
| R150.31   | 502 109 | R152.20   | 301 230 | R153.15   | 971 393 |
| R150.33   | 501 158 | R152.21   | 301 034 | R153.16   | 200 020 |
| R150.40   | 501 513 | R152.22   | 302 046 | R153.19   | 201 084 |
| R151.00   | 401 276 | R152.24   | 302 197 | R153.20   | 202 168 |
| R151.02   | 401 222 | R152.28   | 302 074 | R153.22   | 202 140 |
| R151.03   | 402 030 | R152.29   | 301 038 | R153.23   | 202 142 |
| R151.05   | 401 028 | R152.30   | 301 244 | R153.24   | 202 026 |
| R151.06   | 401 277 | R152.31   | 301 246 | R153.25   | 201 210 |
| R151.07   | 402 116 | R152.32   | 302 120 | R153.26   | 201 228 |
| R151.08   | 401 048 | R152.33   | 302 122 | R153.27   | 202 218 |

## VERGLEICHNUMMERNLISTE

### CROSS REFERENCE GUIDE / LISTE DES ÉQUIVALENCES

| RUL - SNR | OPTIMAL | RUL - SNR | OPTIMAL | RUL - SNR | OPTIMAL |
|-----------|---------|-----------|---------|-----------|---------|
| R153.28   | 201 262 | R154.50   | 102 055 | R155.54   | 702 866 |
| R153.28   | 201 262 | R154.51   | 102 069 | R155.55   | 702 960 |
| R153.30   | 201 031 | R154.52   | 101 029 | R155.56   | 702 321 |
| R153.31   | 201 033 | R154.54   | 102 213 | R155.60   | 702 850 |
| R153.32   | 201 035 | R154.55   | 102 019 | R155.61   | 701 914 |
| R153.33   | 201 043 | R155.01   | 701 826 | R155.63   | 702 312 |
| R153.34   | 202 059 | R155.03   | 702 817 | R155.64   | 701 860 |
| R153.35   | 201 087 | R155.06   | 702 328 | R155.65   | 702 846 |
| R153.37   | 202 021 | R155.07   | 701 975 | R155.66   | 702 958 |
| R153.38   | 202 023 | R155.08   | 701 332 | R155.67   | 702 957 |
| R153.39   | 201 095 | R155.09   | 701 404 | R155.69   | 201 089 |
| R153.41   | 202 519 | R155.10   | 701 374 | R155.70   | 202 101 |
| R153.47   | 201 621 | R155.11   | 701 326 | R155.72   | 700 245 |
| R153.48   | 201 623 | R155.12   | 701 302 | R155.74   | 701 247 |
| R153.49   | 202 627 | R155.12   | 701 319 | R155.75   | 701 977 |
| R153.50   | 202 625 | R155.13   | 702 312 | R155.76   | 701 978 |
| R154.06   | 101 145 | R155.14   | 701 424 | R155.77   | 702 982 |
| R154.08   | 102 094 | R155.15   | 702 380 | R155.98   | 702 915 |
| R154.09   | 102 266 | R155.16   | 700 310 | R156.00   | 600 410 |
| R154.10   | 100 003 | R155.16   | 701 346 | R156.04   | 601 446 |
| R154.12   | 101 044 | R155.17   | 702 316 | R157.05   | 102 008 |
| R154.13   | 100 002 | R155.18   | 702 452 | R157.06   | 100 056 |
| R154.14   | 101 010 | R155.19   | 702 352 | R157.07   | 100 036 |
| R154.15   | 101 147 | R155.21   | 701 432 | R157.08   | 100 090 |
| R154.17   | 101 064 | R155.22   | 702 350 | R157.09   | 100 099 |
| R154.18   | 102 060 | R155.23   | 702 550 | R157.11   | 100 099 |
| R154.19   | 102 054 | R155.24   | 702 514 | R157.13   | 100 093 |
| R154.20   | 101 102 | R155.25   | 702 380 | R157.14   | 100 098 |
| R154.22   | 101 110 | R155.26   | 702 494 | R157.16   | 101 111 |
| R154.23   | 101 016 | R155.27   | 702 426 | R157.17   | 101 111 |
| R154.24   | 101 108 | R155.28   | 702 552 | R157.18   | 100 098 |
| R154.26   | 100 014 | R155.32   | 701 302 | R157.20   | 102 115 |
| R154.28   | 100 022 | R155.38   | 701 307 | R157.21   | 100 098 |
| R154.31   | 102 150 | R155.39   | 702 309 | R157.22   | 101 113 |
| R154.32   | 101 128 | R155.41   | 702 311 | R157.25   | 102 041 |
| R154.33   | 100 206 | R155.42   | 702 313 | R157.26   | 100 053 |
| R154.34   | 101 024 | R155.43   | 702 311 | R157.27   | 102 071 |
| R154.36   | 102 152 | R155.44   | 701 307 | R157.28   | 102 097 |
| R154.37   | 102 154 | R155.45   | 702 363 | R157.31   | 102 077 |
| R154.38   | 100 022 | R155.46   | 702 357 | R158.00   | 801 574 |
| R154.39   | 102 156 | R155.47   | 702 355 | R158.01   | 801 402 |
| R154.41   | 131 129 | R155.48   | 702 365 | R158.02   | 801 538 |
| R154.42   | 132 131 | R155.49   | 702 353 | R158.03   | 801 922 |
| R154.44   | 102 011 | R155.50   | 702 351 | R158.04   | 802 464 |
| R154.46   | 402 117 | R155.51   | 702 359 | R158.07   | 800 408 |
| R154.47   | 402 119 | R155.52   | 701 852 | R158.08   | 801 698 |
| R154.49   | 801 543 | R155.53   | 702 537 | R158.10   | 802 318 |

## VERGLEICHNUMMERNLISTE

### CROSS REFERENCE GUIDE / LISTE DES ÉQUIVALENCES

| RUL - SNR | OPTIMAL | RUL - SNR | OPTIMAL | RUL - SNR | OPTIMAL |
|-----------|---------|-----------|---------|-----------|---------|
| R158.11   | 802 480 | R159.20   | 602 430 | R161.01   | 882 463 |
| R158.12   | 800 304 | R159.21   | 602 539 | R161.01   | 882 598 |
| R158.13   | 801 342 | R159.22   | 602 388 | R161.02   | 882 819 |
| R158.14   | 802 394 | R159.23   | 602 338 | R161.03   | 880 912 |
| R158.15   | 681 259 | R159.24   | 601 348 | R161.05   | 880 525 |
| R158.17   | 802 324 | R159.26   | 602 344 | R161.06   | 881 622 |
| R158.18   | 800 400 | R159.26   | 602 937 | R161.07   | 882 664 |
| R158.19   | 802 370 | R159.29   | 602 314 | R161.08   | 881 534 |
| R158.20   | 802 368 | R159.30   | 602 361 | R161.09   | 881 592 |
| R158.21   | 802 378 | R159.31   | 681 303 | R161.10   | 881 594 |
| R158.22   | 802 330 | R159.32   | 682 305 | R161.11   | 882 643 |
| R158.23   | 802 330 | R159.33   | 602 345 | R161.16   | 882 607 |
| R158.24   | 801 360 | R159.34   | 602 343 | R161.17   | 882 729 |
| R158.25   | 801 450 | R159.35   | 602 369 | R161.18   | 882 727 |
| R158.28   | 800 366 | R159.36   | 602 367 | R161.19   | 882 483 |
| R158.29   | 802 444 | R159.38   | 602 858 | R161.20   | 882 624 |
| R158.30   | 801 382 | R159.39   | 602 249 | R161.21   | 882 626 |
| R158.31   | 801 376 | R159.42   | 602 956 | R161.22   | 882 487 |
| R158.33   | 802 526 | R159.45   | 681 261 | R161.23   | 881 725 |
| R158.34   | 801 364 | R159.46   | 682 263 | R162.50   | 501 161 |
| R158.35   | 801 362 | R159.47   | 601 675 | R162.51   | 502 163 |
| R158.36   | 800 398 | R159.49   | 602 681 | R163.00   | 891 822 |
| R158.37   | 801 730 | R160.00   | 801 238 | R163.02   | 892 804 |
| R158.39   | 802 315 | R160.01   | 801 588 | R164.03   | 891 509 |
| R158.41   | 801 880 | R160.02   | 802 652 | R164.05   | 891 706 |
| R158.43   | 801 838 | R160.03   | 802 646 | R164.06   | 892 830 |
| R158.44   | 801 836 | R160.04   | 981 535 | R164.07   | 892 806 |
| R158.45   | 801 972 | R160.06   | 801 438 | R164.08   | 891 524 |
| R158.46   | 802 839 | R160.07   | 802 556 | R164.09   | 892 670 |
| R158.52   | 802 271 | R160.08   | 801 478 | R164.10   | 891 546 |
| R158.54   | 801 974 | R160.09   | 802 488 | R164.11   | 892 476 |
| R158.55   | 801 267 | R160.12   | 802 558 | R164.12   | 892 668 |
| R159.02   | 602 412 | R160.13   | 802 542 | R164.13   | 891 496 |
| R159.03   | 602 406 | R160.14   | 802 540 | R164.14   | 892 498 |
| R159.04   | 602 541 | R160.16   | 802 560 | R164.15   | 891 630 |
| R159.05   | 601 654 | R160.17   | 802 562 | R164.16   | 202 218 |
| R159.07   | 601 495 | R160.18   | 801 428 | R164.17   | 202 218 |
| R159.08   | 601 384 | R160.19   | 801 554 | R164.18   | 891 887 |
| R159.09   | 602 821 | R160.20   | 801 500 | R165.03   | 892 460 |
| R159.10   | 601 396 | R160.21   | 802 528 | R165.04   | 891 522 |
| R159.11   | 602 859 | R160.22   | 802 335 | R165.05   | 892 458 |
| R159.12   | 602 414 | R160.23   | 802 485 | R165.06   | 892 802 |
| R159.13   | 602 390 | R160.25   | 801 970 | R165.07   | 891 520 |
| R159.14   | 601 306 | R160.26   | 802 870 | R165.08   | 892 474 |
| R159.15   | 602 340 | R160.27   | 802 888 | R165.09   | 892 468 |
| R159.17   | 601 916 | R160.30   | 801 961 | R165.10   | 892 470 |
| R159.19   | 602 320 | R161.00   | 881 507 | R165.11   | 891 484 |

## VERGLEICHNUMMERNLISTE

### CROSS REFERENCE GUIDE / LISTE DES ÉQUIVALENCES

| RUL - SNR | OPTIMAL | RUL - SNR | OPTIMAL | RUL - SNR | OPTIMAL |
|-----------|---------|-----------|---------|-----------|---------|
| R165.13   | 891 536 | R168.04   | 962 684 | R169.04   | 982 764 |
| R165.14   | 891 466 | R168.05   | 962 517 | R169.05   | 982 816 |
| R165.15   | 892 472 | R168.09   | 961 503 | R169.07   | 981 742 |
| R165.16   | 891 486 | R168.10   | 962 776 | R169.08   | 981 572 |
| R165.17   | 891 628 | R168.11   | 961 680 | R169.08   | 981 616 |
| R165.18   | 891 544 | R168.12   | 961 883 | R169.08   | 982 749 |
| R165.19   | 892 733 | R168.13   | 961 792 | R169.09   | 982 778 |
| R165.20   | 892 735 | R168.15   | 962 682 | R169.10   | 982 766 |
| R165.21   | 891 333 | R168.16   | 961 576 | R169.11   | 981 744 |
| R165.21   | 891 482 | R168.17   | 962 760 | R169.12   | 982 373 |
| R165.22   | 892 843 | R168.18   | 960 578 | R169.12   | 982 437 |
| R165.23   | 891 469 | R168.19   | 962 718 | R169.14   | 981 747 |
| R165.24   | 891 477 | R168.20   | 962 716 | R169.14   | 982 780 |
| R165.25   | 891 731 | R168.21   | 960 702 | R169.15   | 190 256 |
| R165.26   | 891 869 | R168.22   | 961 610 | R169.16   | 981 690 |
| R165.27   | 891 878 | R168.23   | 960 578 | R169.17   | 981 447 |
| R165.28   | 892 872 | R168.24   | 962 548 | R169.18   | 982 561 |
| R166.00   | 601 440 | R168.25   | 961 765 | R169.20   | 982 379 |
| R166.01   | 602 418 | R168.26   | 960 638 | R169.21   | 980 614 |
| R166.02   | 601 828 | R168.27   | 962 703 | R169.22   | 981 849 |
| R166.03   | 601 253 | R168.29   | 962 712 | R169.23   | 981 683 |
| R166.03   | 602 416 | R168.30   | 961 648 | R169.24   | 981 851 |
| R166.05   | 602 358 | R168.33   | 962 705 | R169.26   | 981 407 |
| R166.06   | 602 815 | R168.34   | 962 714 | R169.28   | 982 737 |
| R166.08   | 601 434 | R168.35   | 960 638 | R169.31   | 981 743 |
| R166.09   | 602 392 | R168.38   | 962 481 | R169.32   | 981 745 |
| R166.10   | 601 502 | R168.40   | 961 479 | R169.33   | 191 258 |
| R166.11   | 601 336 | R168.41   | 962 899 | R169.34   | 982 431 |
| R166.13   | 600 308 | R168.42   | 961 753 | R169.35   | 982 431 |
| R166.14   | 600 334 | R168.43   | 962 755 | R169.36   | 981 475 |
| R166.15   | 602 322 | R168.44   | 962 757 | R169.37   | 981 868 |
| R166.17   | 601 582 | R168.45   | 961 759 | R169.38   | 981 856 |
| R166.18   | 602 512 | R168.46   | 961 751 | R169.39   | 982 857 |
| R166.19   | 602 865 | R168.47   | 961 903 | R169.41   | 981 763 |
| R166.21   | 602 356 | R168.49   | 962 767 | R169.42   | 982 762 |
| R166.23   | 602 339 | R168.50   | 961 904 | R169.43   | 982 774 |
| R166.24   | 602 337 | R168.51   | 962 913 | R169.43   | 982 884 |
| R166.25   | 602 341 | R168.52   | 962 905 | R169.44   | 982 581 |
| R166.26   | 602 347 | R168.53   | 962 841 | R170.01   | 942 788 |
| R166.27   | 602 349 | R168.54   | 961 411 | R170.02   | 941 497 |
| R166.28   | 601 323 | R168.55   | 962 413 | R170.03   | 941 786 |
| R166.32   | 602 251 | R168.56   | 962 810 | R170.04   | 941 634 |
| R167.03   | 101 270 | R168.57   | 961 701 | R170.05   | 942 674 |
| R167.04   | 102 268 | R169.00   | 982 857 | R170.06   | 942 501 |
| R167.05   | 101 264 | R169.01   | 981 790 | R170.07   | 941 734 |
| R167.06   | 101 250 | R169.02   | 981 814 | R170.08   | 942 566 |
| R168.02   | 961 796 | R169.03   | 982 650 | R170.09   | 941 636 |

## VERGLEICHNUMMERNLISTE

### CROSS REFERENCE GUIDE / LISTE DES ÉQUIVALENCES

| RUL - SNR | OPTIMAL | RUL - SNR | OPTIMAL | RUL - SNR | OPTIMAL |
|-----------|---------|-----------|---------|-----------|---------|
| R170.10   | 942 570 | R174.03   | 911 513 | R177.14   | 971 567 |
| R170.11   | 942 568 | R174.04   | 911 513 | R178.00   | 801 618 |
| R170.12   | 942 770 | R174.05   | 911 621 | R178.01   | 802 720 |
| R170.13   | 942 768 | R174.05   | 911 625 | R178.02   | 801 694 |
| R170.14   | 940 632 | R174.06   | 911 782 | R178.03   | 802 732 |
| R170.15   | 941 602 | R174.08   | 911 375 | R179.00   | 901 461 |
| R170.16   | 942 672 | R174.09   | 912 515 | R179.01   | 902 459 |
| R170.17   | 942 818 | R174.10   | 911 375 | R179.03   | 902 457 |
| R170.18   | 942 820 | R174.12   | 881 704 | R179.06   | 901 427 |
| R170.19   | 941 617 | R174.13   | 911 600 | R179.07   | 901 425 |
| R170.20   | 942 738 | R174.14   | 912 527 | R179.08   | 901 429 |
| R170.21   | 942 619 | R174.16   | 912 532 | R179.11   | 901 549 |
| R170.22   | 941 700 | R174.17   | 912 473 | R179.12   | 901 425 |
| R170.23   | 942 569 | R174.19   | 912 530 | R179.13   | 901 429 |
| R170.24   | 942 773 | R174.20   | 912 471 | R179.14   | 902 443 |
| R170.25   | 941 842 | R174.21   | 911 623 | R179.15   | 902 771 |
| R170.26   | 941 874 | R174.24   | 912 423 | R179.16   | 902 547 |
| R170.27   | 941 784 | R174.25   | 911 377 | R179.17   | 902 855 |
| R170.28   | 942 736 | R174.26   | 912 775 | R180.00   | 880 812 |
| R170.30   | 942 381 | R174.28   | 911 385 | R180.01   | 880 419 |
| R170.31   | 941 862 | R174.29   | 911 387 | R180.02   | 880 421 |
| R170.32   | 940 371 | R174.30   | 911 777 | R181.00   | 971 627 |
| R170.33   | 941 951 | R174.31   | 912 545 | R181.01   | 971 615 |
| R172.00   | 802 454 | R174.32   | 912 403 | R181.02   | 972 639 |
| R172.01   | 801 656 | R174.33   | 911 399 | R181.03   | 972 465 |
| R172.02   | 802 590 | R174.34   | 911 383 | R181.04   | 971 631 |
| R172.03   | 801 442 | R174.38   | 912 803 | R181.05   | 971 635 |
| R172.04   | 802 658 | R174.39   | 912 401 | R181.06   | 971 641 |
| R173.00   | 920 752 | R176.00   | 801 372 | R181.07   | 972 637 |
| R173.01   | 952 832 | R176.00   | 802 620 | R181.08   | 972 633 |
| R173.02   | 951 756 | R176.02   | 802 886 | R182.60   | 801 354 |
| R173.03   | 951 519 | R176.06   | 802 331 | R182.61   | 102 079 |
| R173.05   | 952 593 | R177.01   | 972 573 | R183.00   | 881 564 |
| R173.06   | 951 722 | R177.02   | 971 451 | R183.01   | 882 666 |
| R173.07   | 952 661 | R177.03   | 972 717 | R183.02   | 882 491 |
| R173.07   | 952 936 | R177.04   | 972 719 | R183.03   | 881 489 |
| R173.08   | 951 606 | R177.04   | 972 721 | R184.00   | 922 439 |
| R173.09   | 952 710 | R177.05   | 971 723 | R184.01   | 922 441 |
| R173.10   | 951 449 | R177.06   | 971 575 | R184.02   | 922 781 |
| R173.11   | 952 679 | R177.06   | 971 711 | R184.03   | 922 783 |
| R173.12   | 952 678 | R177.07   | 972 699 | R184.04   | 922 882 |
| R173.13   | 952 676 | R177.08   | 972 453 |           |         |
| R173.14   | 951 604 | R177.09   | 971 455 |           |         |
| R173.16   | 952 608 | R177.10   | 972 453 |           |         |
| R173.17   | 952 415 | R177.11   | 972 571 |           |         |
| R173.18   | 952 417 | R177.12   | 971 612 |           |         |
| R174.02   | 912 505 | R177.13   | 972 688 |           |         |

|  | RUVILLE | OPTIMAL |
|--|---------|---------|
|  | 4000    | 982 884 |
|  | 4001    | 702 846 |
|  | 4002    | 681 640 |
|  | 4003    | 682 642 |
|  | 4006    | 701 860 |



## VERGLEICHNUMMERNLISTE

### CROSS REFERENCE GUIDE / LISTE DES ÉQUIVALENCES

| <b>RUVILLE</b> | <b>OPTIMAL</b> | <b>RUVILLE</b> | <b>OPTIMAL</b> | <b>RUVILLE</b> | <b>OPTIMAL</b> |
|----------------|----------------|----------------|----------------|----------------|----------------|
| 4013           | 681 923        | 4078           | 682 508        | 5032           | 502 252        |
| 4014           | 682 925        | 4079           | 682 510        | 5033           | 501 158        |
| 4015           | 681 924        | 4080           | 302 124        | 5034           | 501 147        |
| 4016           | 682 593        | 4081           | 702 586        | 5036           | 501 121        |
| 4017           | 681 375        | 4082           | 941 565        | 5040           | 501 513        |
| 4018           | 601 580        | 4083           | 682 492        | 5100           | 401 276        |
| 4019           | 602 584        | 4084           | 682 490        | 5100S          | 401 276        |
| 4023           | 701 726        | 4085           | 302 166        | 5102           | 401 222        |
| 4024           | 702 436        | 4086           | 302 164        | 5102S          | 401 222        |
| 4025           | 702 456        | 4087           | 301 118        | 5103           | 402 030        |
| 4026           | 191 272        | 4088           | 402 143        | 5103S          | 402 030        |
| 4027           | 192 274        | 4089           | 982 685        | 5105           | 401 028        |
| 4029           | 801 746        | 4090           | 961 677        | 5105S          | 401 028        |
| 4030           | 941 511        | 4091           | 962 435        | 5106           | 401 277        |
| 4031           | 942 754        | 4092           | 961 724        | 5106S          | 401 277        |
| 4032           | 802 662        | 4094           | 681 325        | 5107           | 402 116        |
| 4033           | 802 660        | 4095           | 682 327        | 5107S          | 402 116        |
| 4034           | 951 708        | 4096           | 682 329        | 5108           | 401 048        |
| 4035           | 952 758        | 4097           | 101 209        | 5108S          | 401 048        |
| 4037           | 682 437        | 4098           | 102 207        | 5109           | 401 104        |
| 4038           | 681 471        | 4099           | 201 085        | 5110           | 402 050        |
| 4039           | 961 808        | 5000           | 501 184        | 5110S          | 402 050        |
| 4041           | 962 686        | 5002           | 501 194        | 5111           | 401 100        |
| 4042           | 681 504        | 5003           | 502 134        | 5112           | 401 126        |
| 4043           | 682 420        | 5007           | 502 178        | 5112S          | 401 126        |
| 4044           | 682 422        | 5009           | 501 092        | 5113S          | 402 116        |
| 4046           | 702 462        | 5010           | 502 070        | 5114           | 401 042        |
| 4047           | 702 448        | 5011           | 501 114        | 5114S          | 401 042        |
| 4052           | 302 172        | 5012           | 502 066        | 5115           | 402 080        |
| 4053           | 302 160        | 5013           | 501 114        | 5116           | 402 080        |
| 4054           | 961 808        | 5014           | 502 158        | 5117           | 401 096        |
| 4055           | 962 686        | 5015           | 501 088        | 5118           | 401 078        |
| 4056           | 702 692        | 5016           | 502 068        | 5119           | 402 116        |
| 4057           | 701 728        | 5017           | 501 088        | 5120           | 401 082        |
| 4058           | 801 750        | 5017           | 501 112        | 5121           | 402 242        |
| 4059           | 801 644        | 5019           | 502 072        | 5122           | 402 242        |
| 4065           | 802 748        | 5020           | 501 170        | 5123           | 401 212        |
| 4066           | 802 740        | 5022           | 501 136        | 5124           | 401 078        |
| 4067           | 302 240        | 5023           | 502 138        | 5125           | 402 242        |
| 4068           | 302 162        | 5024           | 502 148        | 5126           | 400 051        |
| 4069           | 302 174        | 5025           | 502 135        | 5127           | 400 107        |
| 4070           | 302 176        | 5026           | 501 133        | 5128           | 402 243        |
| 4072           | 401 214        | 5027           | 502 135        | 5129           | 402 116        |
| 4072S          | 401 214        | 5028           | 502 125        | 5130           | 402 243        |
| 4073           | 402 216        | 5029           | 502 123        | 5131           | 401 047        |
| 4076           | 401 137        | 5030           | 501 121        | 5132           | 402 063        |
| 4077           | 681 506        | 5031           | 502 109        | 5133           | 400 061        |

## VERGLEICHNUMMERNLISTE

### CROSS REFERENCE GUIDE / LISTE DES ÉQUIVALENCES

| <b>RUVILLE</b> | <b>OPTIMAL</b> | <b>RUVILLE</b> | <b>OPTIMAL</b> | <b>RUVILLE</b> | <b>OPTIMAL</b> |
|----------------|----------------|----------------|----------------|----------------|----------------|
| 5134           | 402 081        | 5250           | 301 139        | 5341           | 202 519        |
| 5135           | 401 083        | 5251           | 301 141        | 5342           | 201 262        |
| 5136           | 401 157        | 5252           | 302 067        | 5347           | 201 621        |
| 5137           | 402 505        | 5253           | 302 037        | 5348           | 201 623        |
| 5138           | 401 501        | 5254           | 301 039        | 5349           | 202 627        |
| 5141           | 402 159        | 5255           | 301 045        | 5350           | 202 625        |
| 5145           | 402 827        | 5256           | 302 057        | 5401           | 101 113        |
| 5202           | 300 062        | 5257           | 301 132        | 5404           | 100 002        |
| 5205           | 301 151        | 5258           | 302 255        | 5406           | 101 145        |
| 5206           | 602 833        | 5259           | 302 257        | 5408           | 102 094        |
| 5208           | 301 280        | 5260           | 301 185        | 5409           | 102 266        |
| 5209           | 302 254        | 5261           | 301 511        | 5410           | 100 003        |
| 5210           | 302 146        | 5262           | 301 667        | 5412           | 101 044        |
| 5212           | 300 052        | 5306           | 202 252        | 5413           | 100 002        |
| 5213           | 302 234        | 5307           | 200 012        | 5414           | 101 010        |
| 5216           | 301 018        | 5307           | 972 389        | 5415           | 101 147        |
| 5217           | 300 004        | 5308           | 202 202        | 5416           | 100 014        |
| 5218           | 301 232        | 5309           | 202 204        | 5417           | 101 064        |
| 5219           | 301 006        | 5310           | 202 236        | 5418           | 102 060        |
| 5220           | 301 230        | 5313           | 202 226        | 5419           | 102 054        |
| 5221           | 301 034        | 5314           | 201 040        | 5420           | 101 102        |
| 5222           | 302 046        | 5314           | 971 391        | 5422           | 101 110        |
| 5223           | 301 183        | 5315           | 201 032        | 5423           | 101 016        |
| 5224           | 302 197        | 5315           | 971 393        | 5424           | 101 108        |
| 5228           | 302 074        | 5316           | 200 020        | 5426           | 100 014        |
| 5229           | 301 038        | 5318           | 201 084        | 5427           | 101 105        |
| 5230           | 301 244        | 5319           | 201 084        | 5428           | 100 022        |
| 5231           | 301 246        | 5320           | 202 168        | 5429           | 100 022        |
| 5232           | 302 120        | 5322           | 202 140        | 5430           | 100 002        |
| 5233           | 302 122        | 5323           | 202 142        | 5431           | 102 150        |
| 5234           | 302 076        | 5324           | 202 026        | 5432           | 101 128        |
| 5235           | 301 130        | 5325           | 201 210        | 5433           | 100 206        |
| 5236           | 301 180        | 5326           | 201 228        | 5434           | 101 024        |
| 5237           | 302 058        | 5327           | 202 218        | 5435           | 101 024        |
| 5237S          | 302 058        | 5328           | 201 262        | 5436           | 102 152        |
| 5238           | 302 058        | 5329           | 202 205        | 5437           | 102 154        |
| 5239           | 301 132        | 5330           | 201 031        | 5438           | 100 022        |
| 5240           | 302 248        | 5331           | 201 033        | 5439           | 102 156        |
| 5241           | 302 260        | 5332           | 201 035        | 5440           | 101 016        |
| 5242           | 301 182        | 5333           | 201 043        | 5441           | 131 129        |
| 5243           | 302 186        | 5334           | 202 059        | 5442           | 132 131        |
| 5244           | 302 188        | 5335           | 201 087        | 5443           | 100 098        |
| 5245           | 302 192        | 5336           | 202 224        | 5444           | 102 011        |
| 5246           | 302 196        | 5337           | 202 021        | 5445           | 102 075        |
| 5247           | 302 190        | 5338           | 202 023        | 5446           | 402 117        |
| 5248           | 301 198        | 5339           | 201 095        | 5447           | 402 119        |
| 5249           | 301 200        | 5340           | 201 517        | 5448           | 102 115        |

## VERGLEICHNUMMERNLISTE

### CROSS REFERENCE GUIDE / LISTE DES ÉQUIVALENCES

| <b>RUVILLE</b> | <b>OPTIMAL</b> | <b>RUVILLE</b> | <b>OPTIMAL</b> | <b>RUVILLE</b> | <b>OPTIMAL</b> |
|----------------|----------------|----------------|----------------|----------------|----------------|
| 5449           | 801 543        | 5539           | 702 380        | 5710           | 100 056        |
| 5450           | 102 055        | 5540           | 702 452        | 5711           | 100 099        |
| 5451           | 102 069        | 5541           | 702 311        | 5712           | 102 008        |
| 5452           | 101 029        | 5542           | 702 313        | 5713           | 100 093        |
| 5454           | 102 213        | 5543           | 702 550        | 5714           | 100 098        |
| 5455           | 102 019        | 5544           | 701 307        | 5715           | 102 008        |
| 5456           | 101 017        | 5545           | 702 363        | 5716           | 101 111        |
| 5457           | 100 007        | 5546           | 702 357        | 5717           | 101 111        |
| 5458           | 100 013        | 5547           | 702 355        | 5718           | 100 098        |
| 5459           | 100 013        | 5548           | 702 365        | 5719           | 100 091        |
| 5461           | 102 075        | 5549           | 702 353        | 5720           | 102 115        |
| 5462           | 100 013        | 5550           | 702 351        | 5721           | 100 098        |
| 5501           | 701 826        | 5551           | 702 359        | 5722           | 101 113        |
| 5502           | 701 852        | 5552           | 701 852        | 5723           | 100 091        |
| 5503           | 702 817        | 5553           | 702 537        | 5724           | 100 098        |
| 5506           | 702 328        | 5554           | 702 866        | 5725           | 102 041        |
| 5507           | 701 975        | 5555           | 702 960        | 5726           | 100 053        |
| 5508           | 701 332        | 5556           | 702 321        | 5727           | 102 071        |
| 5509           | 701 404        | 5557           | 700 310        | 5728           | 102 097        |
| 5510           | 701 374        | 5558           | 702 426        | 5730           | 100 098        |
| 5511           | 701 326        | 5559           | 701 307        | 5731           | 102 077        |
| 5512           | 701 319        | 5560           | 702 850        | 5732           | 101 027        |
| 5513           | 702 312        | 5561           | 701 914        | 5733           | 101 029        |
| 5514           | 701 424        | 5562           | 701 302        | 5800           | 801 574        |
| 5515           | 702 380        | 5563           | 702 312        | 5801           | 801 402        |
| 5516           | 700 310        | 5564           | 701 860        | 5802           | 801 538        |
| 5516           | 701 346        | 5565           | 702 846        | 5803           | 801 922        |
| 5517           | 702 316        | 5566           | 702 958        | 5804           | 802 464        |
| 5518           | 702 452        | 5567           | 702 957        | 5804S          | 802 464        |
| 5519           | 702 352        | 5568           | 702 959        | 5807           | 800 408        |
| 5521           | 701 432        | 5569           | 201 089        | 5808           | 801 698        |
| 5522           | 702 350        | 5570           | 202 101        | 5810           | 802 318        |
| 5523           | 702 550        | 5571           | 201 085        | 5811           | 802 480        |
| 5524           | 702 514        | 5572           | 700 245        | 5812           | 800 304        |
| 5525           | 702 380        | 5574           | 701 247        | 5813           | 801 342        |
| 5526           | 702 494        | 5575           | 701 977        | 5814           | 802 394        |
| 5527           | 702 426        | 5576           | 701 978        | 5815           | 681 259        |
| 5528           | 702 552        | 5577           | 702 982        | 5816           | 802 954        |
| 5529           | 701 302        | 5598           | 702 915        | 5817           | 802 324        |
| 5531           | 701 302        | 5600           | 600 410        | 5818           | 800 400        |
| 5532           | 701 302        | 5604           | 601 446        | 5819           | 802 370        |
| 5534           | 700 310        | 5704           | 100 036        | 5820           | 802 368        |
| 5535           | 702 312        | 5705           | 102 008        | 5821           | 802 378        |
| 5536           | 702 316        | 5706           | 100 056        | 5822           | 802 330        |
| 5537           | 702 765        | 5707           | 100 036        | 5823           | 802 330        |
| 5538           | 701 307        | 5708           | 100 090        | 5824           | 801 360        |
| 5539           | 702 309        | 5709           | 100 099        | 5825           | 801 450        |

## VERGLEICHNUMMERNLISTE

### CROSS REFERENCE GUIDE / LISTE DES ÉQUIVALENCES

| RUVILLE | OPTIMAL | RUVILLE | OPTIMAL | RUVILLE | OPTIMAL |
|---------|---------|---------|---------|---------|---------|
| 5828    | 800 366 | 5924    | 601 348 | 6026    | 802 870 |
| 5829    | 802 444 | 5925    | 602 344 | 6027    | 802 888 |
| 5830    | 801 382 | 5926    | 602 344 | 6030    | 801 961 |
| 5831    | 801 376 | 5926    | 602 937 | 6100    | 881 507 |
| 5832    | 800 398 | 5929    | 602 314 | 6101    | 882 463 |
| 5833    | 802 526 | 5930    | 602 361 | 6101    | 882 598 |
| 5834    | 801 364 | 5931    | 681 303 | 6102    | 882 819 |
| 5835    | 801 362 | 5932    | 682 305 | 6103    | 880 912 |
| 5836    | 800 398 | 5933    | 602 345 | 6105    | 880 525 |
| 5837    | 801 730 | 5934    | 602 343 | 6106    | 881 622 |
| 5838    | 682 305 | 5935    | 602 369 | 6107    | 882 664 |
| 5839    | 802 315 | 5936    | 602 367 | 6108    | 881 534 |
| 5840    | 801 269 | 5937    | 602 337 | 6109    | 881 592 |
| 5841    | 801 880 | 5938    | 602 858 | 6110    | 881 594 |
| 5842    | 801 950 | 5939    | 602 249 | 6111    | 882 643 |
| 5843    | 801 838 | 5940    | 602 645 | 6112    | 881 609 |
| 5844    | 801 836 | 5941    | 602 927 | 6113    | 882 611 |
| 5845    | 801 972 | 5942    | 602 956 | 6114    | 882 613 |
| 5846    | 802 839 | 5943    | 602 339 | 6115    | 882 463 |
| 5847    | 802 605 | 5944    | 601 953 | 6116    | 882 607 |
| 5848    | 802 601 | 5945    | 681 261 | 6117    | 882 729 |
| 5852    | 802 271 | 5946    | 682 263 | 6118    | 882 727 |
| 5853    | 802 980 | 5947    | 601 675 | 6119    | 882 483 |
| 5854    | 801 974 | 5949    | 602 681 | 6120    | 882 624 |
| 5855    | 801 267 | 5999    | 682 305 | 6121    | 882 626 |
| 5856    | 802 265 | 6000    | 801 238 | 6122    | 882 487 |
| 5902    | 602 412 | 6001    | 801 588 | 6123    | 881 725 |
| 5903    | 602 406 | 6002    | 802 652 | 6126    | 881 237 |
| 5904    | 602 541 | 6003    | 802 646 | 6127    | 882 235 |
| 5905    | 601 654 | 6004    | 981 535 | 6128    | 882 167 |
| 5906    | 602 815 | 6006    | 801 438 | 6200    | 601 521 |
| 5907    | 601 495 | 6007    | 802 556 | 6250    | 501 161 |
| 5908    | 601 384 | 6008    | 801 478 | 6251    | 502 163 |
| 5909    | 602 821 | 6009    | 802 488 | 6300    | 891 822 |
| 5910    | 601 396 | 6012    | 802 558 | 6302    | 892 804 |
| 5911    | 602 859 | 6013    | 802 542 | 6403    | 891 509 |
| 5912    | 602 414 | 6014    | 802 540 | 6405    | 891 706 |
| 5913    | 602 390 | 6015    | 801 500 | 6406    | 892 830 |
| 5914    | 601 306 | 6016    | 802 560 | 6407    | 892 806 |
| 5915    | 602 340 | 6017    | 802 562 | 6408    | 891 524 |
| 5916    | 601 336 | 6018    | 801 428 | 6409    | 892 670 |
| 5917    | 601 916 | 6019    | 801 554 | 6410    | 891 546 |
| 5919    | 602 320 | 6020    | 801 500 | 6411    | 892 476 |
| 5920    | 602 430 | 6021    | 802 528 | 6412    | 892 668 |
| 5921    | 602 539 | 6022    | 802 335 | 6413    | 891 496 |
| 5922    | 602 388 | 6023    | 802 485 | 6414    | 892 498 |
| 5923    | 602 338 | 6025    | 801 970 | 6415    | 891 630 |

**VERGLEICHNUMMERNLISTE**
**CROSS REFERENCE GUIDE / LISTE DES ÉQUIVALENCES**

| <b>RUVILLE</b> | <b>OPTIMAL</b> | <b>RUVILLE</b> | <b>OPTIMAL</b> | <b>RUVILLE</b> | <b>OPTIMAL</b> |
|----------------|----------------|----------------|----------------|----------------|----------------|
| 6416           | 202 218        | 6615           | 602 926        | 6836           | 962 949        |
| 6417           | 202 218        | 6617           | 601 582        | 6837           | 962 548        |
| 6418           | 891 887        | 6618           | 602 512        | 6838           | 962 481        |
| 6503           | 892 460        | 6619           | 602 865        | 6839           | 961 753        |
| 6504           | 891 522        | 6621           | 602 356        | 6840           | 961 479        |
| 6505           | 892 458        | 6622           | 602 314        | 6841           | 962 899        |
| 6506           | 892 802        | 6623           | 602 339        | 6842           | 961 753        |
| 6507           | 891 520        | 6624           | 602 337        | 6843           | 962 755        |
| 6508           | 892 474        | 6625           | 602 341        | 6844           | 962 757        |
| 6509           | 892 468        | 6626           | 602 347        | 6845           | 961 759        |
| 6510           | 892 470        | 6627           | 602 349        | 6846           | 961 751        |
| 6511           | 891 484        | 6628           | 601 323        | 6847           | 961 903        |
| 6512           | 891 333        | 6629           | 602 345        | 6848           | 961 765        |
| 6513           | 891 536        | 6630           | 602 386        | 6849           | 962 767        |
| 6514           | 891 466        | 6631           | 602 955        | 6850           | 961 904        |
| 6515           | 892 472        | 6632           | 602 251        | 6851           | 962 913        |
| 6516           | 891 486        | 6702           | 102 103        | 6852           | 962 905        |
| 6517           | 891 628        | 6703           | 101 270        | 6853           | 962 841        |
| 6518           | 891 544        | 6704           | 102 268        | 6854           | 961 411        |
| 6519           | 892 733        | 6705           | 101 264        | 6855           | 962 413        |
| 6520           | 892 735        | 6706           | 101 250        | 6856           | 962 810        |
| 6521           | 891 482        | 6802           | 961 796        | 6857           | 961 701        |
| 6522           | 892 843        | 6804           | 962 684        | 6900           | 982 857        |
| 6523           | 891 469        | 6805           | 962 517        | 6901           | 981 790        |
| 6524           | 891 477        | 6809           | 961 503        | 6902           | 981 814        |
| 6525           | 891 731        | 6810           | 962 776        | 6903           | 982 650        |
| 6526           | 891 869        | 6811           | 961 680        | 6904           | 982 764        |
| 6527           | 891 878        | 6812           | 961 883        | 6905           | 982 816        |
| 6528           | 892 872        | 6813           | 961 792        | 6907           | 981 742        |
| 6529           | 891 928        | 6815           | 962 682        | 6908           | 981 572        |
| 6530           | 892 929        | 6816           | 961 576        | 6908           | 982 749        |
| 6531           | 891 591        | 6817           | 962 760        | 6909           | 982 778        |
| 6600           | 601 440        | 6818           | 960 578        | 6910           | 982 766        |
| 6601           | 602 418        | 6819           | 962 718        | 6911           | 981 744        |
| 6602           | 601 828        | 6820           | 962 716        | 6912           | 982 373        |
| 6603           | 601 253        | 6821           | 960 702        | 6912           | 982 437        |
| 6603           | 602 416        | 6822           | 961 610        | 6914           | 981 747        |
| 6605           | 602 358        | 6823           | 960 578        | 6914           | 982 780        |
| 6606           | 602 815        | 6824           | 962 548        | 6915           | 190 256        |
| 6607           | 602 669        | 6825           | 961 765        | 6916           | 981 690        |
| 6608           | 601 434        | 6826           | 960 638        | 6917           | 981 447        |
| 6609           | 602 392        | 6827           | 962 703        | 6918           | 982 561        |
| 6610           | 601 502        | 6829           | 962 712        | 6919           | 981 744        |
| 6611           | 601 336        | 6830           | 961 648        | 6920           | 982 379        |
| 6613           | 600 308        | 6833           | 962 705        | 6921           | 980 614        |
| 6614           | 600 334        | 6834           | 962 714        | 6922           | 981 849        |
| 6615           | 602 322        | 6835           | 960 638        | 6923           | 981 683        |

## VERGLEICHNUMMERNLISTE

### CROSS REFERENCE GUIDE / LISTE DES ÉQUIVALENCES

| <b>RUVILLE</b> | <b>OPTIMAL</b> | <b>RUVILLE</b> | <b>OPTIMAL</b> | <b>RUVILLE</b> | <b>OPTIMAL</b> |
|----------------|----------------|----------------|----------------|----------------|----------------|
| 6924           | 981 851        | 7021           | 942 619        | 7403           | 911 513        |
| 6925           | 982 561        | 7022           | 941 700        | 7404           | 911 513        |
| 6926           | 981 407        | 7022           | 941 840        | 7405           | 911 621        |
| 6928           | 982 737        | 7023           | 942 569        | 7405           | 911 625        |
| 6929           | 981 938        | 7024           | 942 773        | 7406           | 911 782        |
| 6930           | 982 379        | 7025           | 941 842        | 7408           | 911 375        |
| 6930           | 982 939        | 7026           | 941 874        | 7409           | 912 515        |
| 6931           | 981 743        | 7027           | 941 784        | 7410           | 911 375        |
| 6932           | 981 745        | 7028           | 942 736        | 7411           | 911 375        |
| 6933           | 191 258        | 7030           | 942 381        | 7412           | 881 704        |
| 6934           | 982 431        | 7031           | 941 862        | 7413           | 911 600        |
| 6935           | 982 431        | 7032           | 940 371        | 7414           | 912 527        |
| 6936           | 981 475        | 7033           | 941 951        | 7415           | 912 530        |
| 6937           | 981 868        | 7035           | 942 177        | 7416           | 912 532        |
| 6938           | 981 856        | 7037           | 942 273        | 7417           | 912 473        |
| 6939           | 982 857        | 7200           | 802 454        | 7419           | 912 530        |
| 6940           | 982 857        | 7201           | 801 656        | 7420           | 912 471        |
| 6941           | 981 763        | 7202           | 802 590        | 7421           | 911 623        |
| 6942           | 982 762        | 7203           | 801 442        | 7423           | 912 530        |
| 6943           | 982 774        | 7204           | 802 658        | 7424           | 912 423        |
| 6944           | 982 581        | 7300           | 920 752        | 7425           | 911 377        |
| 6946           | 981 499        | 7301           | 952 832        | 7426           | 912 775        |
| 6947           | 981 533        | 7302           | 951 756        | 7428           | 911 385        |
| 6948           | 982 811        | 7303           | 951 519        | 7429           | 911 387        |
| 6949           | 982 813        | 7305           | 952 593        | 7430           | 911 777        |
| 6950           | 981 616        | 7306           | 951 722        | 7431           | 912 545        |
| 6951           | 982 195        | 7307           | 952 661        | 7432           | 912 403        |
| 7001           | 942 788        | 7307           | 952 936        | 7433           | 911 399        |
| 7002           | 941 497        | 7308           | 951 606        | 7434           | 911 383        |
| 7003           | 941 786        | 7309           | 952 710        | 7435           | 912 530        |
| 7004           | 941 634        | 7310           | 951 449        | 7436           | 911 385        |
| 7005           | 942 674        | 7311           | 952 679        | 7437           | 912 775        |
| 7006           | 942 501        | 7312           | 952 678        | 7438           | 912 803        |
| 7007           | 941 734        | 7313           | 952 676        | 7439           | 912 401        |
| 7008           | 942 566        | 7314           | 951 604        | 7440           | 911 647        |
| 7009           | 941 636        | 7315           | 951 606        | 7600           | 801 372        |
| 7010           | 942 570        | 7316           | 952 608        | 7600           | 802 620        |
| 7011           | 942 568        | 7317           | 952 415        | 7602           | 802 886        |
| 7012           | 942 770        | 7318           | 952 417        | 7606           | 802 331        |
| 7013           | 942 768        | 7319           | 952 769        | 7607           | 802 233        |
| 7014           | 940 632        | 7321           | 952 935        | 7701           | 972 573        |
| 7015           | 941 602        | 7322           | 951 409        | 7702           | 971 451        |
| 7016           | 942 672        | 7323           | 952 405        | 7703           | 972 717        |
| 7017           | 942 818        | 7324           | 952 551        | 7704           | 972 719        |
| 7018           | 942 820        | 7325           | 991 902        | 7704           | 972 721        |
| 7019           | 941 617        | 7326           | 992 894        | 7705           | 971 723        |
| 7020           | 942 738        | 7402           | 912 505        | 7706           | 971 575        |

**VERGLEICHSNUMMERNLISTE**
**CROSS REFERENCE GUIDE / LISTE DES ÉQUIVALENCES**

| <b>RUVILLE</b> | <b>OPTIMAL</b> | <b>RUVILLE</b> | <b>OPTIMAL</b> | <b>SKF</b> | <b>OPTIMAL</b> |
|----------------|----------------|----------------|----------------|------------|----------------|
| 7706           | 971 711        | 8300           | 881 564        | VKBA 544   | 301 232        |
| 7707           | 972 699        | 8301           | 882 666        | VKBA 546   | 602 859        |
| 7708           | 972 453        | 8302           | 882 491        | VKBA 547   | 602 541        |
| 7709           | 971 455        | 8303           | 881 489        | VKBA 548   | 702 817        |
| 7710           | 972 453        | 8304           | 880 493        | VKBA 551   | 600 410        |
| 7711           | 972 571        | 8400           | 922 439        | VKBA 559   | 800 408        |
| 7712           | 971 612        | 8401           | 922 441        | VKBA 562   | 802 464        |
| 7713           | 972 688        | 8402           | 922 781        | VKBA 568   | 882 861        |
| 7714           | 971 567        | 8403           | 922 783        | VKBA 571   | 892 460        |
| 7800           | 801 618        | 8404           | 922 882        | VKBA 575   | 100 014        |
| 7801           | 802 720        | 8405           | 951 962        | VKBA 576   | 101 147        |
| 7802           | 801 694        | 8406           | 951 282        | VKBA 577   | 101 044        |
| 7803           | 802 732        | 8410           | 922 979        | VKBA 580   | 882 819        |
| 7805           | 101 025        | 8411           | 922 921        | VKBA 581   | 882 863        |
| 7900           | 901 461        | 8450           | 971 391        | VKBA 583   | 502 134        |
| 7901           | 902 459        | 8452           | 972 918        | VKBA 586   | 802 646        |
| 7902           | 901 461        | 8453           | 971 917        | VKBA 592   | 102 266        |
| 7903           | 902 457        | 8600           | 992 943        | VKBA 593   | 101 010        |
| 7906           | 901 427        | 8601           | 991 898        | VKBA 594   | 801 238        |
| 7907           | 901 425        | 8602           | 991 946        | VKBA 596   | 401 028        |
| 7908           | 901 429        | 8602           | 991 998        | VKBA 597   | 802 662        |
| 7910           | 902 457        | 8701           | 401 300        | VKBA 598   | 802 660        |
| 7911           | 901 549        | 8702           | 402 301        | VKBA 599   | 892 804        |
| 7912           | 901 425        | 8930           | 922 825        | VKBA 600   | 801 746        |
| 7913           | 901 429        |                |                | VKBA 602   | 602 412        |
| 7914           | 902 443        |                |                | VKBA 607   | 802 480        |
| 7915           | 902 771        | <b>SKF</b>     | <b>OPTIMAL</b> | VKBA 611   | 601 654        |
| 7916           | 902 547        | VKBA 310       | 802 394        | VKBA 612   | 601 396        |
| 7917           | 902 855        | VKBA 502       | 891 822        | VKBA 613   | 100 036        |
| 7918           | 901 445        | VKBA 504       | 300 052        | VKBA 614   | 402 030        |
| 8000           | 880 812        | VKBA 505       | 301 280        | VKBA 617   | 602 821        |
| 8001           | 880 419        | VKBA 513       | 981 535        | VKBA 618   | 601 495        |
| 8002           | 880 421        | VKBA 515       | 501 184        | VKBA 622   | 602 406        |
| 8100           | 971 627        | VKBA 516       | 401 276        | VKBA 623   | 502 178        |
| 8101           | 971 615        | VKBA 517       | 401 222        | VKBA 624   | 302 234        |
| 8102           | 972 639        | VKBA 519       | 101 145        | VKBA 625   | 802 318        |
| 8103           | 972 465        | VKBA 523       | 300 062        | VKBA 636   | 701 374        |
| 8104           | 971 631        | VKBA 526       | 200 020        | VKBA 638   | 701 432        |
| 8105           | 971 635        | VKBA 527       | 981 814        | VKBA 639   | 701 826        |
| 8106           | 971 641        | VKBA 528       | 300 004        | VKBA 652   | 702 328        |
| 8107           | 972 637        | VKBA 529       | 100 002        | VKBA 654   | 702 350        |
| 8108           | 972 633        | VKBA 531       | 501 194        | VKBA 655   | 941 497        |
| 8109           | 971 707        | VKBA 532       | 802 652        | VKBA 657   | 942 788        |
| 8110           | 972 709        | VKBA 534       | 981 790        | VKBA 658   | 880 525        |
| 8111           | 971 285        | VKBA 539       | 301 151        | VKBA 661   | 941 786        |
| 8260           | 801 354        | VKBA 540       | 601 384        | VKBA 663   | 201 040        |
| 8261           | 102 079        | VKBA 541       | 602 815        | VKBA 665   | 602 358        |
|                |                | VKBA 542       | 102 008        |            |                |
|                |                | VKBA 543       | 301 230        |            |                |

## VERGLEICHNUMMERNLISTE

### CROSS REFERENCE GUIDE / LISTE DES ÉQUIVALENCES

| SKF      | OPTIMAL | SKF      | OPTIMAL | SKF      | OPTIMAL |
|----------|---------|----------|---------|----------|---------|
| VKBA 666 | 602 392 | VKBA 749 | 881 592 | VKBA 858 | 881 879 |
| VKBA 667 | 801 588 | VKBA 750 | 882 596 | VKBA 859 | 912 515 |
| VKBA 668 | 942 501 | VKBA 751 | 961 680 | VKBA 861 | 302 146 |
| VKBA 671 | 912 505 | VKBA 752 | 962 776 | VKBA 862 | 502 158 |
| VKBA 673 | 962 684 | VKBA 753 | 941 873 | VKBA 866 | 882 666 |
| VKBA 674 | 982 650 | VKBA 754 | 202 026 | VKBA 867 | 881 564 |
| VKBA 675 | 982 764 | VKBA 755 | 982 816 | VKBA 868 | 701 302 |
| VKBA 676 | 601 828 | VKBA 756 | 401 048 | VKBA 869 | 702 312 |
| VKBA 678 | 601 440 | VKBA 757 | 402 116 | VKBA 871 | 601 434 |
| VKBA 679 | 602 865 | VKBA 758 | 881 527 | VKBA 880 | 602 881 |
| VKBA 680 | 961 796 | VKBA 759 | 882 875 | VKBA 882 | 601 306 |
| VKBA 684 | 961 503 | VKBA 769 | 602 833 | VKBA 885 | 802 488 |
| VKBA 685 | 800 304 | VKBA 782 | 881 529 | VKBA 886 | 961 883 |
| VKBA 686 | 301 018 | VKBA 787 | 202 252 | VKBA 887 | 962 517 |
| VKBA 687 | 301 006 | VKBA 788 | 882 531 | VKBA 889 | 501 092 |
| VKBA 697 | 202 226 | VKBA 792 | 801 478 | VKBA 890 | 501 088 |
| VKBA 702 | 892 830 | VKBA 800 | 102 054 | VKBA 891 | 501 114 |
| VKBA 708 | 801 618 | VKBA 801 | 102 060 | VKBA 892 | 602 418 |
| VKBA 709 | 802 720 | VKBA 802 | 101 064 | VKBA 893 | 602 416 |
| VKBA 713 | 920 752 | VKBA 804 | 601 580 | VKBA 894 | 961 792 |
| VKBA 714 | 951 756 | VKBA 805 | 602 584 | VKBA 895 | 801 372 |
| VKBA 715 | 952 832 | VKBA 806 | 681 919 | VKBA 896 | 802 620 |
| VKBA 717 | 942 674 | VKBA 813 | 681 640 | VKBA 897 | 302 074 |
| VKBA 718 | 801 554 | VKBA 814 | 682 642 | VKBA 898 | 302 076 |
| VKBA 719 | 891 522 | VKBA 824 | 931 877 | VKBA 899 | 941 734 |
| VKBA 720 | 601 502 | VKBA 825 | 932 794 | VKBA 904 | 942 566 |
| VKBA 723 | 701 332 | VKBA 826 | 191 272 | VKBA 905 | 951 519 |
| VKBA 725 | 802 558 | VKBA 827 | 192 274 | VKBA 906 | 101 016 |
| VKBA 726 | 802 556 | VKBA 828 | 702 436 | VKBA 907 | 892 802 |
| VKBA 727 | 881 507 | VKBA 829 | 701 726 | VKBA 908 | 701 424 |
| VKBA 728 | 602 414 | VKBA 830 | 702 456 | VKBA 909 | 701 404 |
| VKBA 729 | 602 390 | VKBA 831 | 401 028 | VKBA 910 | 102 094 |
| VKBA 730 | 882 598 | VKBA 834 | 941 511 | VKBA 911 | 101 102 |
| VKBA 732 | 891 520 | VKBA 835 | 942 754 | VKBA 912 | 101 108 |
| VKBA 733 | 892 458 | VKBA 836 | 101 110 | VKBA 913 | 891 546 |
| VKBA 734 | 801 342 | VKBA 838 | 880 812 | VKBA 914 | 892 476 |
| VKBA 736 | 201 032 | VKBA 840 | 961 808 | VKBA 915 | 600 308 |
| VKBA 737 | 881 871 | VKBA 841 | 962 686 | VKBA 916 | 301 244 |
| VKBA 738 | 601 446 | VKBA 843 | 682 920 | VKBA 917 | 301 246 |
| VKBA 739 | 941 634 | VKBA 844 | 681 504 | VKBA 918 | 302 120 |
| VKBA 740 | 301 034 | VKBA 845 | 682 420 | VKBA 919 | 302 122 |
| VKBA 741 | 301 038 | VKBA 846 | 682 422 | VKBA 920 | 301 130 |
| VKBA 742 | 302 046 | VKBA 847 | 701 728 | VKBA 921 | 302 160 |
| VKBA 743 | 602 340 | VKBA 848 | 702 448 | VKBA 922 | 302 172 |
| VKBA 744 | 891 509 | VKBA 849 | 702 462 | VKBA 923 | 302 162 |
| VKBA 745 | 891 706 | VKBA 852 | 881 523 | VKBA 924 | 302 208 |
| VKBA 746 | 892 806 | VKBA 857 | 911 513 | VKBA 925 | 801 402 |



## VERGLEICHNUMMERNLISTE

### CROSS REFERENCE GUIDE / LISTE DES ÉQUIVALENCES

| SKF       | OPTIMAL | SKF       | OPTIMAL | SKF       | OPTIMAL |
|-----------|---------|-----------|---------|-----------|---------|
| VKBA 926  | 801 574 | VKBA 1303 | 802 368 | VKBA 1354 | 942 738 |
| VKBA 927  | 801 538 | VKBA 1304 | 802 370 | VKBA 1355 | 100 090 |
| VKBA 928  | 801 922 | VKBA 1306 | 801 442 | VKBA 1355 | 100 091 |
| VKBA 929  | 801 698 | VKBA 1307 | 802 658 | VKBA 1355 | 100 093 |
| VKBA 933  | 892 474 | VKBA 1308 | 700 310 | VKBA 1356 | 100 098 |
| VKBA 935  | 682 921 | VKBA 1309 | 892 668 | VKBA 1356 | 100 099 |
| VKBA 936  | 881 622 | VKBA 1310 | 962 682 | VKBA 1358 | 100 022 |
| VKBA 937  | 882 664 | VKBA 1311 | 602 539 | VKBA 1359 | 961 576 |
| VKBA 938  | 501 112 | VKBA 1312 | 602 430 | VKBA 1360 | 962 762 |
| VKBA 939  | 501 114 | VKBA 1313 | 891 482 | VKBA 1361 | 962 760 |
| VKBA 940  | 802 324 | VKBA 1314 | 892 468 | VKBA 1362 | 960 578 |
| VKBA 941  | 401 042 | VKBA 1315 | 891 484 | VKBA 1363 | 962 718 |
| VKBA 942  | 891 524 | VKBA 1317 | 502 068 | VKBA 1364 | 962 716 |
| VKBA 943  | 892 670 | VKBA 1318 | 502 066 | VKBA 1365 | 960 702 |
| VKBA 944  | 200 012 | VKBA 1319 | 502 070 | VKBA 1366 | 951 606 |
| VKBA 947  | 942 568 | VKBA 1320 | 502 072 | VKBA 1367 | 952 710 |
| VKBA 948  | 942 570 | VKBA 1321 | 942 768 | VKBA 1368 | 952 661 |
| VKBA 949  | 941 636 | VKBA 1322 | 942 770 | VKBA 1369 | 951 708 |
| VKBA 951  | 302 254 | VKBA 1323 | 302 240 | VKBA 1370 | 952 758 |
| VKBA 954  | 101 264 | VKBA 1324 | 801 656 | VKBA 1371 | 952 593 |
| VKBA 955  | 102 268 | VKBA 1325 | 802 590 | VKBA 1372 | 911 621 |
| VKBA 956  | 101 270 | VKBA 1326 | 202 168 | VKBA 1373 | 911 623 |
| VKBA 957  | 302 174 | VKBA 1327 | 600 334 | VKBA 1374 | 881 704 |
| VKBA 958  | 302 176 | VKBA 1328 | 602 322 | VKBA 1375 | 912 532 |
| VKBA 959  | 302 124 | VKBA 1329 | 601 582 | VKBA 1377 | 911 600 |
| VKBA 961  | 602 320 | VKBA 1330 | 602 512 | VKBA 1378 | 912 471 |
| VKBA 962  | 100 056 | VKBA 1331 | 602 388 | VKBA 1379 | 912 530 |
| VKBA 963  | 802 540 | VKBA 1332 | 301 180 | VKBA 1380 | 911 625 |
| VKBA 964  | 802 542 | VKBA 1333 | 302 058 | VKBA 1381 | 911 375 |
| VKBA 965  | 102 150 | VKBA 1336 | 601 336 | VKBA 1382 | 911 782 |
| VKBA 966  | 701 326 | VKBA 1337 | 401 126 | VKBA 1383 | 940 632 |
| VKBA 967  | 702 380 | VKBA 1338 | 501 170 | VKBA 1384 | 912 473 |
| VKBA 968  | 702 380 | VKBA 1339 | 401 096 | VKBA 1385 | 801 750 |
| VKBA 968  | 702 452 | VKBA 1340 | 981 616 | VKBA 1386 | 801 644 |
| VKBA 969  | 702 352 | VKBA 1341 | 981 572 | VKBA 1393 | 802 748 |
| VKBA 972  | 702 550 | VKBA 1342 | 981 744 | VKBA 1394 | 802 740 |
| VKBA 973  | 802 454 | VKBA 1343 | 981 742 | VKBA 1396 | 401 100 |
| VKBA 974  | 702 552 | VKBA 1344 | 982 766 | VKBA 1397 | 401 104 |
| VKBA 975  | 702 316 | VKBA 1345 | 982 778 | VKBA 1400 | 101 250 |
| VKBA 976  | 702 426 | VKBA 1346 | 982 780 | VKBA 1401 | 801 450 |
| VKBA 977  | 702 692 | VKBA 1347 | 402 080 | VKBA 1402 | 801 360 |
| VKBA 979  | 601 521 | VKBA 1348 | 941 602 | VKBA 1403 | 800 400 |
| VKBA 990  | 202 236 | VKBA 1349 | 942 672 | VKBA 1405 | 602 338 |
| VKBA 992  | 202 202 | VKBA 1350 | 941 617 | VKBA 1406 | 702 514 |
| VKBA 994  | 202 204 | VKBA 1351 | 942 619 | VKBA 1407 | 881 534 |
| VKBA 1301 | 201 084 | VKBA 1352 | 942 818 | VKBA 1408 | 891 496 |
| VKBA 1302 | 800 400 | VKBA 1353 | 942 820 | VKBA 1409 | 892 498 |

## VERGLEICHNUMMERNLISTE

### CROSS REFERENCE GUIDE / LISTE DES ÉQUIVALENCES

| SKF       | OPTIMAL | SKF       | OPTIMAL | SKF       | OPTIMAL |
|-----------|---------|-----------|---------|-----------|---------|
| VKBA 1410 | 801 354 | VKBA 1464 | 881 609 | VKBA 1917 | 941 647 |
| VKBA 1411 | 602 356 | VKBA 1465 | 301 118 | VKBA 1918 | 931 649 |
| VKBA 1412 | 601 348 | VKBA 1466 | 302 164 | VKBA 1919 | 942 651 |
| VKBA 1413 | 701 302 | VKBA 1467 | 302 166 | VKBA 1921 | 982 653 |
| VKBA 1414 | 800 366 | VKBA 1468 | 882 611 | VKBA 1922 | 981 655 |
| VKBA 1415 | 971 627 | VKBA 1469 | 882 613 | VKBA 1924 | 951 657 |
| VKBA 1416 | 911 629 | VKBA 1470 | 402 050 | VKBA 1925 | 951 659 |
| VKBA 1417 | 971 615 | VKBA 1471 | 202 140 | VKBA 1926 | 901 461 |
| VKBA 1418 | 971 631 | VKBA 1472 | 202 142 | VKBA 1927 | 902 459 |
| VKBA 1419 | 972 633 | VKBA 1474 | 682 911 | VKBA 1928 | 941 874 |
| VKBA 1420 | 972 465 | VKBA 1475 | 602 314 | VKBA 1929 | 902 457 |
| VKBA 1421 | 971 635 | VKBA 1476 | 802 526 | VKBA 1930 | 971 455 |
| VKBA 1422 | 972 637 | VKBA 1477 | 102 152 | VKBA 1931 | 972 453 |
| VKBA 1423 | 972 639 | VKBA 1478 | 301 198 | VKBA 1933 | 971 575 |
| VKBA 1424 | 971 641 | VKBA 1479 | 301 200 | VKBA 1936 | 951 807 |
| VKBA 1430 | 802 732 | VKBA 1480 | 301 182 | VKBA 1937 | 952 809 |
| VKBA 1431 | 301 180 | VKBA 1481 | 302 186 | VKBA 1938 | 952 577 |
| VKBA 1432 | 301 132 | VKBA 1482 | 302 188 | VKBA 1940 | 901 890 |
| VKBA 1433 | 302 248 | VKBA 1483 | 302 190 | VKBA 1941 | 902 891 |
| VKBA 1434 | 891 536 | VKBA 1484 | 302 192 | VKBA 1942 | 902 901 |
| VKBA 1435 | 891 466 | VKBA 1485 | 302 196 | VKBA 1943 | 901 895 |
| VKBA 1436 | 892 470 | VKBA 1486 | 802 528 | VKBA 1944 | 901 896 |
| VKBA 1437 | 892 472 | VKBA 1487 | 801 438 | VKBA 1945 | 902 897 |
| VKBA 1438 | 801 376 | VKBA 1488 | 801 500 | VKBA 1946 | 942 671 |
| VKBA 1439 | 800 398 | VKBA 1490 | 602 344 | VKBA 1947 | 941 673 |
| VKBA 1440 | 802 330 | VKBA 1491 | 101 024 | VKBA 1948 | 940 371 |
| VKBA 1441 | 802 378 | VKBA 1492 | 882 626 | VKBA 1949 | 942 569 |
| VKBA 1442 | 801 382 | VKBA 1493 | 882 624 | VKBA 1950 | 941 700 |
| VKBA 1443 | 802 444 | VKBA 1494 | 702 494 | VKBA 1951 | 191 258 |
| VKBA 1444 | 681 506 | VKBA 1495 | 891 486 | VKBA 1952 | 962 601 |
| VKBA 1445 | 682 508 | VKBA 1496 | 102 154 | VKBA 1953 | 962 899 |
| VKBA 1446 | 682 510 | VKBA 1497 | 102 156 | VKBA 1954 | 961 675 |
| VKBA 1447 | 801 428 | VKBA 1498 | 401 078 | VKBA 1955 | 961 677 |
| VKBA 1449 | 802 560 | VKBA 1499 | 401 082 | VKBA 1956 | 952 661 |
| VKBA 1450 | 802 562 | VKBA 1643 | 991 898 | VKBA 1957 | 962 603 |
| VKBA 1451 | 401 137 | VKBA 1903 | 931 663 | VKBA 1958 | 962 605 |
| VKBA 1452 | 881 594 | VKBA 1904 | 932 665 | VKBA 1959 | 952 679 |
| VKBA 1453 | 882 643 | VKBA 1905 | 982 581 | VKBA 1960 | 951 606 |
| VKBA 1454 | 882 463 | VKBA 1906 | 982 800 | VKBA 1961 | 952 676 |
| VKBA 1455 | 302 260 | VKBA 1907 | 981 798 | VKBA 1962 | 952 678 |
| VKBA 1456 | 501 170 | VKBA 1908 | 932 667 | VKBA 1963 | 931 681 |
| VKBA 1458 | 501 136 | VKBA 1909 | 190 256 | VKBA 1964 | 981 683 |
| VKBA 1459 | 502 138 | VKBA 1910 | 931 669 | VKBA 1965 | 981 447 |
| VKBA 1460 | 502 148 | VKBA 1911 | 981 690 | VKBA 1966 | 982 685 |
| VKBA 1461 | 202 065 | VKBA 1913 | 982 373 | VKBA 1967 | 961 724 |
| VKBA 1462 | 682 492 | VKBA 1914 | 981 579 | VKBA 1970 | 951 604 |
| VKBA 1463 | 682 490 | VKBA 1915 | 951 722 | VKBA 1971 | 972 571 |

**VERGLEICHNUMMERNLISTE**
**CROSS REFERENCE GUIDE / LISTE DES ÉQUIVALENCES**

| SKF       | OPTIMAL | SKF       | OPTIMAL | SKF       | OPTIMAL |
|-----------|---------|-----------|---------|-----------|---------|
| VKBA 1972 | 972 573 | VKBA 3229 | 942 381 | VKBA 3301 | 911 777 |
| VKBA 1973 | 951 449 | VKBA 3232 | 962 853 | VKBA 3302 | 911 399 |
| VKBA 1974 | 901 885 | VKBA 3234 | 982 379 | VKBA 3303 | 912 401 |
| VKBA 1976 | 902 900 | VKBA 3234 | 982 948 | VKBA 3304 | 912 403 |
| VKBA 1978 | 971 451 | VKBA 3235 | 971 707 | VKBA 3305 | 952 405 |
| VKBA 1979 | 971 567 | VKBA 3236 | 972 709 | VKBA 3306 | 992 894 |
| VKBA 1980 | 941 687 | VKBA 3237 | 981 475 | VKBA 3307 | 991 902 |
| VKBA 1981 | 941 689 | VKBA 3240 | 982 431 | VKBA 3308 | 981 407 |
| VKBA 1982 | 941 691 | VKBA 3241 | 982 431 | VKBA 3309 | 951 409 |
| VKBA 1983 | 942 693 | VKBA 3245 | 911 377 | VKBA 3310 | 961 751 |
| VKBA 1984 | 942 695 | VKBA 3246 | 911 383 | VKBA 3311 | 961 753 |
| VKBA 1985 | 201 262 | VKBA 3250 | 911 385 | VKBA 3312 | 962 755 |
| VKBA 1986 | 931 697 | VKBA 3251 | 911 387 | VKBA 3313 | 962 757 |
| VKBA 1988 | 972 699 | VKBA 3252 | 962 779 | VKBA 3314 | 961 759 |
| VKBA 1989 | 912 518 | VKBA 3252 | 962 807 | VKBA 3315 | 961 751 |
| VKBA 1990 | 901 445 | VKBA 3254 | 912 292 | VKBA 3316 | 961 903 |
| VKBA 1991 | 902 443 | VKBA 3255 | 972 389 | VKBA 3317 | 961 765 |
| VKBA 1992 | 922 441 | VKBA 3256 | 971 391 | VKBA 3318 | 962 767 |
| VKBA 1993 | 922 439 | VKBA 3257 | 971 393 | VKBA 3319 | 961 904 |
| VKBA 1994 | 922 797 | VKBA 3259 | 922 395 | VKBA 3320 | 962 913 |
| VKBA 1995 | 922 799 | VKBA 3263 | 922 217 | VKBA 3321 | 962 905 |
| VKBA 1996 | 982 437 | VKBA 3264 | 922 219 | VKBA 3322 | 901 549 |
| VKBA 1997 | 941 563 | VKBA 3265 | 922 221 | VKBA 3323 | 952 551 |
| VKBA 1998 | 941 565 | VKBA 3266 | 922 781 | VKBA 3324 | 992 894 |
| VKBA 1999 | 960 638 | VKBA 3267 | 922 783 | VKBA 3325 | 952 769 |
| VKBA 3200 | 962 810 | VKBA 3270 | 922 189 | VKBA 3326 | 952 415 |
| VKBA 3201 | 961 648 | VKBA 3271 | 922 697 | VKBA 3327 | 952 417 |
| VKBA 3202 | 962 712 | VKBA 3272 | 961 229 | VKBA 3328 | 912 545 |
| VKBA 3204 | 962 714 | VKBA 3277 | 921 553 | VKBA 3329 | 902 547 |
| VKBA 3205 | 961 801 | VKBA 3279 | 922 787 | VKBA 3330 | 962 841 |
| VKBA 3206 | 962 435 | VKBA 3280 | 922 789 | VKBA 3331 | 961 411 |
| VKBA 3207 | 962 847 | VKBA 3281 | 961 900 | VKBA 3332 | 962 413 |
| VKBA 3209 | 941 784 | VKBA 3282 | 912 292 | VKBA 3341 | 982 737 |
| VKBA 3210 | 942 736 | VKBA 3283 | 972 397 | VKBA 3342 | 982 379 |
| VKBA 3213 | 980 614 | VKBA 3284 | 921 555 | VKBA 3343 | 982 379 |
| VKBA 3214 | 981 849 | VKBA 3285 | 922 557 | VKBA 3344 | 981 743 |
| VKBA 3215 | 982 559 | VKBA 3286 | 971 791 | VKBA 3345 | 981 745 |
| VKBA 3216 | 981 851 | VKBA 3287 | 972 793 | VKBA 3346 | 981 747 |
| VKBA 3217 | 982 561 | VKBA 3288 | 971 795 | VKBA 3347 | 982 749 |
| VKBA 3218 | 952 608 | VKBA 3293 | 901 429 | VKBA 3348 | 911 969 |
| VKBA 3219 | 971 612 | VKBA 3294 | 901 427 | VKBA 3349 | 912 293 |
| VKBA 3220 | 972 688 | VKBA 3295 | 902 771 | VKBA 3349 | 912 992 |
| VKBA 3221 | 961 701 | VKBA 3296 | 902 855 | VKBA 3382 | 902 906 |
| VKBA 3222 | 962 703 | VKBA 3297 | 901 425 | VKBA 3400 | 402 242 |
| VKBA 3223 | 962 705 | VKBA 3298 | 942 773 | VKBA 3401 | 891 544 |
| VKBA 3224 | 961 610 | VKBA 3299 | 912 775 | VKBA 3402 | 892 733 |
| VKBA 3225 | 962 548 | VKBA 3300 | 912 423 | VKBA 3403 | 201 210 |

## VERGLEICHNUMMERNLISTE

### CROSS REFERENCE GUIDE / LISTE DES ÉQUIVALENCES

| SKF       | OPTIMAL | SKF       | OPTIMAL | SKF       | OPTIMAL |
|-----------|---------|-----------|---------|-----------|---------|
| VKBA 3404 | 401 214 | VKBA 3451 | 501 133 | VKBA 3498 | 882 607 |
| VKBA 3405 | 402 216 | VKBA 3452 | 502 135 | VKBA 3499 | 502 109 |
| VKBA 3406 | 100 206 | VKBA 3453 | 602 369 | VKBA 3500 | 701 860 |
| VKBA 3406 | 101 128 | VKBA 3454 | 602 367 | VKBA 3501 | 702 846 |
| VKBA 3406 | 101 209 | VKBA 3455 | 101 113 | VKBA 3502 | 801 970 |
| VKBA 3407 | 702 586 | VKBA 3456 | 102 115 | VKBA 3503 | 802 870 |
| VKBA 3408 | 701 346 | VKBA 3457 | 882 487 | VKBA 3504 | 701 852 |
| VKBA 3409 | 202 142 | VKBA 3458 | 892 843 | VKBA 3506 | 702 850 |
| VKBA 3410 | 201 228 | VKBA 3459 | 802 485 | VKBA 3508 | 681 909 |
| VKBA 3411 | 202 218 | VKBA 3460 | 882 483 | VKBA 3509 | 681 910 |
| VKBA 3412 | 891 630 | VKBA 3461 | 881 725 | VKBA 3510 | 201 033 |
| VKBA 3413 | 801 364 | VKBA 3462 | 882 727 | VKBA 3511 | 201 035 |
| VKBA 3414 | 801 362 | VKBA 3463 | 882 729 | VKBA 3512 | 201 031 |
| VKBA 3415 | 891 628 | VKBA 3464 | 702 359 | VKBA 3513 | 201 043 |
| VKBA 3416 | 801 730 | VKBA 3465 | 602 361 | VKBA 3514 | 202 059 |
| VKBA 3417 | 401 212 | VKBA 3466 | 702 351 | VKBA 3517 | 302 037 |
| VKBA 3418 | 892 735 | VKBA 3467 | 702 353 | VKBA 3518 | 400 061 |
| VKBA 3420 | 880 419 | VKBA 3468 | 702 355 | VKBA 3519 | 102 055 |
| VKBA 3421 | 880 421 | VKBA 3469 | 702 357 | VKBA 3520 | 401 047 |
| VKBA 3422 | 202 140 | VKBA 3470 | 702 363 | VKBA 3521 | 402 063 |
| VKBA 3423 | 681 303 | VKBA 3471 | 702 365 | VKBA 3522 | 400 051 |
| VKBA 3424 | 682 305 | VKBA 3472 | 881 489 | VKBA 3523 | 891 878 |
| VKBA 3425 | 891 333 | VKBA 3473 | 882 491 | VKBA 3524 | 892 872 |
| VKBA 3426 | 402 143 | VKBA 3474 | 880 493 | VKBA 3525 | 702 312 |
| VKBA 3427 | 101 111 | VKBA 3475 | 402 119 | VKBA 3526 | 891 869 |
| VKBA 3428 | 681 325 | VKBA 3476 | 602 343 | VKBA 3527 | 880 912 |
| VKBA 3429 | 682 327 | VKBA 3477 | 602 337 | VKBA 3528 | 801 880 |
| VKBA 3430 | 682 329 | VKBA 3478 | 602 339 | VKBA 3529 | 501 049 |
| VKBA 3431 | 301 139 | VKBA 3479 | 602 341 | VKBA 3530 | 301 039 |
| VKBA 3432 | 301 141 | VKBA 3480 | 602 347 | VKBA 3531 | 301 045 |
| VKBA 3433 | 802 331 | VKBA 3481 | 602 349 | VKBA 3532 | 302 057 |
| VKBA 3434 | 401 137 | VKBA 3482 | 602 345 | VKBA 3534 | 202 218 |
| VKBA 3435 | 402 117 | VKBA 3483 | 702 537 | VKBA 3535 | 102 041 |
| VKBA 3436 | 802 335 | VKBA 3484 | 202 218 | VKBA 3536 | 100 053 |
| VKBA 3437 | 701 307 | VKBA 3485 | 302 067 | VKBA 3538 | 801 836 |
| VKBA 3438 | 702 309 | VKBA 3486 | 400 107 | VKBA 3539 | 801 838 |
| VKBA 3439 | 702 311 | VKBA 3487 | 891 477 | VKBA 3540 | 802 839 |
| VKBA 3440 | 702 313 | VKBA 3488 | 891 469 | VKBA 3541 | 802 888 |
| VKBA 3441 | 801 543 | VKBA 3489 | 102 011 | VKBA 3542 | 702 958 |
| VKBA 3442 | 802 315 | VKBA 3490 | 601 323 | VKBA 3543 | 891 887 |
| VKBA 3443 | 891 731 | VKBA 3491 | 702 321 | VKBA 3544 | 802 886 |
| VKBA 3444 | 501 121 | VKBA 3492 | 701 914 | VKBA 3545 | 602 386 |
| VKBA 3445 | 502 123 | VKBA 3494 | 801 694 | VKBA 3546 | 602 645 |
| VKBA 3446 | 502 125 | VKBA 3495 | 701 307 | VKBA 3548 | 102 075 |
| VKBA 3447 | 502 135 | VKBA 3496 | 701 302 | VKBA 3549 | 102 069 |
| VKBA 3449 | 131 129 | VKBA 3496 | 701 319 | VKBA 3550 | 101 029 |
| VKBA 3450 | 132 131 | VKBA 3497 | 702 866 | VKBA 3551 | 681 923 |

**VERGLEICHNUMMERNLISTE**
**CROSS REFERENCE GUIDE / LISTE DES ÉQUIVALENCES**

| SKF       | OPTIMAL | SKF       | OPTIMAL | SKF       | OPTIMAL |
|-----------|---------|-----------|---------|-----------|---------|
| VKBA 3552 | 682 925 | VKBA 3604 | 882 235 | VKBA 3665 | 501 088 |
| VKBA 3553 | 681 924 | VKBA 3605 | 102 097 | VKBA 3665 | 501 112 |
| VKBA 3554 | 601 916 | VKBA 3606 | 102 071 | VKBA 3666 | 302 058 |
| VKBA 3555 | 202 218 | VKBA 3608 | 701 975 | VKBA 3667 | 501 136 |
| VKBA 3556 | 602 858 | VKBA 3610 | 882 896 | VKBA 3668 | 502 135 |
| VKBA 3557 | 602 926 | VKBA 3611 | 882 167 | VKBA 3670 | 501 653 |
| VKBA 3558 | 702 960 | VKBA 3613 | 701 860 | VKBA 3671 | 501 147 |
| VKBA 3559 | 702 959 | VKBA 3614 | 702 846 | VKBA 3673 | 502 163 |
| VKBA 3560 | 602 927 | VKBA 3615 | 700 245 | VKBA 3674 | 501 161 |
| VKBA 3561 | 702 957 | VKBA 3616 | 201 085 | VKBA 3675 | 502 252 |
| VKBA 3563 | 891 928 | VKBA 3617 | 202 101 | VKBA 3676 | 702 983 |
| VKBA 3564 | 602 249 | VKBA 3618 | 201 089 | VKBA 3681 | 501 513 |
| VKBA 3565 | 401 083 | VKBA 3620 | 201 517 | VKBA 3683 | 601 675 |
| VKBA 3566 | 402 081 | VKBA 3621 | 501 114 | VKBA 3684 | 601 834 |
| VKBA 3567 | 102 077 | VKBA 3624 | 202 519 | VKBA 3685 | 402 467 |
| VKBA 3568 | 101 025 | VKBA 3625 | 301 511 | VKBA 3693 | 602 681 |
| VKBA 3569 | 101 027 | VKBA 3626 | 891 591 | VKBA 3697 | 602 835 |
| VKBA 3570 | 102 079 | VKBA 3627 | 892 587 | VKBA 3700 | 901 876 |
| VKBA 3571 | 201 087 | VKBA 3628 | 402 243 | VKBA 3701 | 902 908 |
| VKBA 3572 | 202 224 | VKBA 3631 | 892 589 | VKBA 3703 | 961 479 |
| VKBA 3573 | 892 929 | VKBA 3632 | 892 929 | VKBA 3704 | 962 481 |
| VKBA 3574 | 501 158 | VKBA 3633 | 681 261 | VKBA 3710 | 951 971 |
| VKBA 3575 | 301 183 | VKBA 3635 | 682 263 | VKBA 3712 | 922 854 |
| VKBA 3576 | 302 197 | VKBA 3636 | 802 233 | VKBA 3713 | 972 715 |
| VKBA 3577 | 801 950 | VKBA 3637 | 701 977 | VKBA 3714 | 971 711 |
| VKBA 3578 | 801 972 | VKBA 3638 | 701 978 | VKBA 3715 | 972 717 |
| VKBA 3580 | 801 961 | VKBA 3639 | 702 982 | VKBA 3716 | 972 719 |
| VKBA 3582 | 802 271 | VKBA 3640 | 681 375 | VKBA 3717 | 972 721 |
| VKBA 3583 | 802 980 | VKBA 3641 | 681 471 | VKBA 3718 | 971 723 |
| VKBA 3584 | 601 953 | VKBA 3642 | 682 437 | VKBA 3724 | 952 995 |
| VKBA 3585 | 602 956 | VKBA 3643 | 101 017 | VKBA 3725 | 952 995 |
| VKBA 3587 | 602 337 | VKBA 3644 | 102 019 | VKBA 3726 | 981 499 |
| VKBA 3588 | 301 185 | VKBA 3645 | 100 003 | VKBA 3727 | 981 533 |
| VKBA 3589 | 302 255 | VKBA 3646 | 100 013 | VKBA 3728 | 982 762 |
| VKBA 3590 | 302 257 | VKBA 3647 | 891 477 | VKBA 3729 | 981 856 |
| VKBA 3592 | 602 345 | VKBA 3647 | 891 928 | VKBA 3730 | 981 868 |
| VKBA 3593 | 600 308 | VKBA 3648 | 701 247 | VKBA 3731 | 982 857 |
| VKBA 3594 | 602 955 | VKBA 3649 | 681 259 | VKBA 3732 | 982 857 |
| VKBA 3596 | 700 310 | VKBA 3650 | 201 621 | VKBA 3739 | 981 763 |
| VKBA 3597 | 802 826 | VKBA 3651 | 201 623 | VKBA 3740 | 982 774 |
| VKBA 3597 | 802 839 | VKBA 3652 | 202 625 | VKBA 3748 | 912 803 |
| VKBA 3598 | 801 974 | VKBA 3653 | 202 627 | VKBA 3756 | 982 884 |
| VKBA 3599 | 801 267 | VKBA 3656 | 102 213 | VKBA 3757 | 931 930 |
| VKBA 3600 | 201 095 | VKBA 3657 | 601 253 | VKBA 3758 | 932 933 |
| VKBA 3601 | 202 021 | VKBA 3658 | 602 669 | VKBA 3760 | 932 934 |
| VKBA 3602 | 202 023 | VKBA 3659 | 602 251 | VKBA 3761 | 931 931 |
| VKBA 3603 | 881 237 | VKBA 3660 | 301 667 | VKBA 3763 | 981 805 |

## VERGLEICHNUMMERNLISTE

### CROSS REFERENCE GUIDE / LISTE DES ÉQUIVALENCES

| SKF       | OPTIMAL |
|-----------|---------|
| VKBA 3764 | 982 811 |
| VKBA 3765 | 982 813 |
| VKBA 3770 | 922 882 |
| VKBA 3771 | 931 932 |
| VKBA 3772 | 942 845 |
| VKBA 3773 | 942 844 |
| VKBA 3774 | 952 935 |
| VKBA 3775 | 952 936 |
| VKBA 3779 | 941 842 |
| VKBA 3780 | 941 840 |
| VKBA 3781 | 941 862 |
| VKBA 3782 | 912 191 |
| VKBA 3784 | 932 864 |
| VKBA 3785 | 971 393 |
| VKBA 3786 | 971 391 |
| VKBA 3791 | 951 606 |
| VKBA 3792 | 922 187 |
| VKBA 3793 | 922 223 |
| VKBA 3794 | 922 921 |
| VKBA 3794 | 922 979 |
| VKBA 3795 | 922 979 |
| VKBA 3796 | 972 918 |
| VKBA 3797 | 971 455 |
| VKBA 3798 | 912 193 |
| VKBA 3901 | 971 917 |
| VKBA 3902 | 971 940 |
| VKBA 3906 | 951 282 |
| VKBA 3907 | 951 962 |
| VKBA 3909 | 921 215 |
| VKBA 3914 | 962 227 |
| VKBA 3922 | 971 612 |
| VKBA 3928 | 962 981 |
| VKBA 3929 | 981 938 |
| VKBA 3930 | 982 939 |
| VKBA 3931 | 982 195 |
| VKBA 3932 | 942 273 |
| VKBA 3933 | 922 179 |
| VKBA 3934 | 922 181 |
| VKBA 3935 | 941 941 |
| VKBA 3936 | 942 942 |
| VKBA 3945 | 981 475 |
| VKBA 3951 | 911 802 |
| VKBA 3952 | 912 804 |
| VKBA 3953 | 912 804 |
| VKBA 3959 | 981 199 |
| VKBA 3961 | 911 831 |
| VKBA 5240 | 681 907 |

| SKF       | OPTIMAL |
|-----------|---------|
| VKBA 5248 | 682 892 |
| VKBA 5274 | 682 593 |
| VKBA 6525 | 301 583 |
| VKBA 6526 | 301 585 |
| VKBA 6527 | 302 595 |
| VKBA 6528 | 302 597 |
| VKBA 6831 | 981 149 |

| SPIDAN   | OPTIMAL |
|----------|---------|
| 0.026302 | 681 640 |
| 0.026303 | 682 642 |
| 0.026318 | 601 580 |
| 0.026319 | 602 584 |
| 0.026323 | 701 726 |
| 0.026324 | 702 436 |
| 0.026325 | 702 456 |
| 0.026326 | 191 272 |
| 0.026327 | 192 274 |
| 0.026329 | 941 511 |
| 0.026330 | 942 754 |
| 0.026333 | 951 708 |
| 0.026334 | 952 758 |
| 0.026336 | 961 808 |
| 0.026337 | 962 686 |
| 0.026338 | 681 504 |
| 0.026339 | 682 420 |
| 0.026340 | 682 422 |
| 0.026341 | 701 424 |
| 0.026342 | 702 462 |
| 0.026343 | 702 448 |
| 0.026348 | 302 172 |
| 0.026349 | 302 160 |
| 0.026350 | 501 184 |
| 0.026352 | 501 194 |
| 0.026353 | 502 134 |
| 0.026355 | 502 178 |
| 0.026357 | 501 092 |
| 0.026358 | 502 070 |
| 0.026359 | 501 114 |
| 0.026360 | 502 066 |
| 0.026361 | 501 114 |
| 0.026362 | 502 158 |
| 0.026363 | 501 088 |
| 0.026364 | 502 068 |
| 0.026365 | 501 112 |
| 0.026367 | 502 072 |
| 0.026368 | 501 170 |
| 0.026371 | 401 276 |

| SPIDAN   | OPTIMAL |
|----------|---------|
| 0.026375 | 401 222 |
| 0.026377 | 402 030 |
| 0.026380 | 401 028 |
| 0.026384 | 402 116 |
| 0.026386 | 401 048 |
| 0.026387 | 401 104 |
| 0.026388 | 402 050 |
| 0.026389 | 401 100 |
| 0.026391 | 401 126 |
| 0.026392 | 402 116 |
| 0.026394 | 401 042 |
| 0.026395 | 402 080 |
| 0.026396 | 402 080 |
| 0.026399 | 300 062 |
| 0.026402 | 301 151 |
| 0.026405 | 301 280 |
| 0.026406 | 302 254 |
| 0.026407 | 302 146 |
| 0.026409 | 300 052 |
| 0.026410 | 302 234 |
| 0.026412 | 301 018 |
| 0.026413 | 300 004 |
| 0.026414 | 301 232 |
| 0.026415 | 301 006 |
| 0.026416 | 301 230 |
| 0.026417 | 301 034 |
| 0.026418 | 302 046 |
| 0.026419 | 302 074 |
| 0.026420 | 301 038 |
| 0.026421 | 301 244 |
| 0.026422 | 301 246 |
| 0.026423 | 302 120 |
| 0.026424 | 302 122 |
| 0.026425 | 302 076 |
| 0.026426 | 301 130 |
| 0.026430 | 202 252 |
| 0.026431 | 200 012 |
| 0.026432 | 202 202 |
| 0.026433 | 202 204 |
| 0.026434 | 202 236 |
| 0.026436 | 202 226 |
| 0.026437 | 201 040 |
| 0.026438 | 201 032 |
| 0.026438 | 202 026 |
| 0.026439 | 200 020 |
| 0.026441 | 201 084 |
| 0.026442 | 201 084 |

## VERGLEICHNUMMERNLISTE

### CROSS REFERENCE GUIDE / LISTE DES ÉQUIVALENCES

| SPIDAN   | OPTIMAL | SPIDAN   | OPTIMAL | SPIDAN   | OPTIMAL |
|----------|---------|----------|---------|----------|---------|
| 0.026443 | 202 168 | 0.026519 | 800 400 | 0.026581 | 601 440 |
| 0.026450 | 101 145 | 0.026520 | 802 370 | 0.026582 | 602 418 |
| 0.026452 | 102 094 | 0.026521 | 802 368 | 0.026583 | 601 828 |
| 0.026453 | 102 266 | 0.026524 | 602 412 | 0.026584 | 602 416 |
| 0.026456 | 101 044 | 0.026525 | 602 406 | 0.026586 | 602 358 |
| 0.026457 | 100 002 | 0.026526 | 602 541 | 0.026587 | 602 815 |
| 0.026458 | 101 010 | 0.026527 | 601 654 | 0.026588 | 601 434 |
| 0.026461 | 101 064 | 0.026528 | 602 815 | 0.026589 | 602 392 |
| 0.026462 | 102 060 | 0.026529 | 601 495 | 0.026590 | 601 502 |
| 0.026463 | 102 054 | 0.026530 | 601 384 | 0.026591 | 601 336 |
| 0.026464 | 101 102 | 0.026531 | 602 821 | 0.026593 | 600 308 |
| 0.026466 | 101 110 | 0.026532 | 601 396 | 0.026596 | 101 270 |
| 0.026467 | 101 016 | 0.026533 | 602 859 | 0.026597 | 102 268 |
| 0.026468 | 101 108 | 0.026534 | 602 414 | 0.026600 | 961 796 |
| 0.026470 | 100 014 | 0.026535 | 602 390 | 0.026602 | 962 684 |
| 0.026470 | 101 147 | 0.026536 | 601 306 | 0.026603 | 962 517 |
| 0.026473 | 701 826 | 0.026537 | 602 340 | 0.026604 | 961 503 |
| 0.026475 | 702 817 | 0.026538 | 601 336 | 0.026605 | 962 776 |
| 0.026478 | 702 328 | 0.026539 | 602 320 | 0.026606 | 961 680 |
| 0.026479 | 701 332 | 0.026540 | 801 238 | 0.026607 | 961 883 |
| 0.026480 | 701 404 | 0.026541 | 801 588 | 0.026608 | 961 792 |
| 0.026481 | 701 374 | 0.026542 | 802 652 | 0.026610 | 962 682 |
| 0.026482 | 701 326 | 0.026543 | 802 646 | 0.026612 | 981 790 |
| 0.026483 | 701 302 | 0.026544 | 981 535 | 0.026613 | 981 814 |
| 0.026484 | 702 312 | 0.026546 | 801 438 | 0.026614 | 982 650 |
| 0.026485 | 702 452 | 0.026547 | 802 556 | 0.026615 | 982 764 |
| 0.026486 | 700 310 | 0.026548 | 801 478 | 0.026616 | 982 816 |
| 0.026487 | 702 316 | 0.026549 | 802 488 | 0.026618 | 981 742 |
| 0.026488 | 702 452 | 0.026551 | 881 507 | 0.026619 | 981 572 |
| 0.026489 | 600 410 | 0.026552 | 882 598 | 0.026620 | 982 778 |
| 0.026493 | 601 446 | 0.026556 | 880 525 | 0.026622 | 942 788 |
| 0.026497 | 100 036 | 0.026558 | 891 822 | 0.026623 | 941 497 |
| 0.026499 | 100 056 | 0.026560 | 892 804 | 0.026624 | 941 786 |
| 0.026500 | 100 036 | 0.026564 | 891 509 | 0.026625 | 941 634 |
| 0.026501 | 801 574 | 0.026566 | 891 706 | 0.026626 | 942 674 |
| 0.026502 | 801 402 | 0.026567 | 892 830 | 0.026627 | 942 501 |
| 0.026503 | 801 538 | 0.026568 | 892 806 | 0.026628 | 941 734 |
| 0.026504 | 801 922 | 0.026569 | 891 524 | 0.026629 | 942 566 |
| 0.026505 | 802 464 | 0.026570 | 892 670 | 0.026633 | 802 454 |
| 0.026508 | 800 408 | 0.026571 | 891 546 | 0.026634 | 801 656 |
| 0.026509 | 801 698 | 0.026572 | 892 476 | 0.026635 | 802 590 |
| 0.026511 | 802 318 | 0.026575 | 892 460 | 0.026636 | 920 752 |
| 0.026512 | 802 480 | 0.026576 | 891 522 | 0.026637 | 952 832 |
| 0.026513 | 800 304 | 0.026577 | 892 458 | 0.026638 | 951 756 |
| 0.026514 | 801 342 | 0.026578 | 892 802 | 0.026639 | 951 519 |
| 0.026515 | 802 394 | 0.026579 | 891 520 | 0.026640 | 952 593 |
| 0.026518 | 802 324 | 0.026580 | 892 474 | 0.026643 | 912 505 |

## VERGLEICHNUMMERNLISTE

### CROSS REFERENCE GUIDE / LISTE DES ÉQUIVALENCES

| SPIDAN   | OPTIMAL | SPIDAN   | OPTIMAL | SPIDAN   | OPTIMAL |
|----------|---------|----------|---------|----------|---------|
| 0.026644 | 911 513 | 0.026711 | 882 664 | 0.026760 | 101 264 |
| 0.026645 | 911 513 | 0.026712 | 892 668 | 0.026765 | 702 312 |
| 0.026646 | 911 621 | 0.026713 | 892 468 | 0.026766 | 700 310 |
| 0.026647 | 911 782 | 0.026714 | 892 470 | 0.026768 | 971 627 |
| 0.026649 | 911 375 | 0.026715 | 891 484 | 0.026769 | 972 639 |
| 0.026650 | 912 515 | 0.026716 | 600 334 | 0.026770 | 971 615 |
| 0.026652 | 911 375 | 0.026717 | 602 322 | 0.026771 | 972 465 |
| 0.026653 | 881 704 | 0.026718 | 602 340 | 0.026774 | 971 575 |
| 0.026654 | 911 600 | 0.026719 | 961 576 | 0.026775 | 972 453 |
| 0.026656 | 912 530 | 0.026720 | 962 760 | 0.026776 | 972 453 |
| 0.026657 | 912 532 | 0.026721 | 982 766 | 0.026777 | 972 699 |
| 0.026658 | 912 473 | 0.026722 | 981 744 | 0.026778 | 971 451 |
| 0.026661 | 801 372 | 0.026723 | 941 636 | 0.026780 | 982 780 |
| 0.026661 | 802 620 | 0.026724 | 942 570 | 0.026782 | 982 373 |
| 0.026669 | 801 618 | 0.026725 | 942 568 | 0.026783 | 891 482 |
| 0.026670 | 802 720 | 0.026726 | 801 442 | 0.026787 | 302 240 |
| 0.026671 | 901 461 | 0.026727 | 802 658 | 0.026788 | 302 162 |
| 0.026672 | 902 459 | 0.026728 | 951 722 | 0.026789 | 302 176 |
| 0.026674 | 902 457 | 0.026729 | 952 661 | 0.026790 | 302 174 |
| 0.026675 | 961 808 | 0.026731 | 880 812 | 0.026791 | 801 750 |
| 0.026676 | 962 686 | 0.026732 | 601 582 | 0.026792 | 801 644 |
| 0.026677 | 702 692 | 0.026733 | 602 512 | 0.026798 | 802 748 |
| 0.026678 | 701 728 | 0.026734 | 401 096 | 0.026799 | 802 740 |
| 0.026679 | 100 022 | 0.026736 | 301 180 | 0.026800 | 401 214 |
| 0.026682 | 102 150 | 0.026737 | 302 058 | 0.026801 | 402 216 |
| 0.026684 | 702 352 | 0.026738 | 911 623 | 0.026802 | 401 137 |
| 0.026685 | 701 432 | 0.026738 | 911 629 | 0.026803 | 681 506 |
| 0.026686 | 702 350 | 0.026739 | 912 471 | 0.026804 | 682 508 |
| 0.026687 | 702 550 | 0.026740 | 912 530 | 0.026805 | 682 510 |
| 0.026688 | 702 514 | 0.026742 | 881 534 | 0.026806 | 801 500 |
| 0.026689 | 702 494 | 0.026743 | 940 632 | 0.026807 | 802 560 |
| 0.026690 | 702 494 | 0.026744 | 941 617 | 0.026808 | 802 562 |
| 0.026691 | 702 426 | 0.026745 | 942 738 | 0.026809 | 801 428 |
| 0.026692 | 702 552 | 0.026746 | 941 602 | 0.026810 | 501 136 |
| 0.026693 | 100 090 | 0.026747 | 942 672 | 0.026812 | 602 356 |
| 0.026696 | 802 378 | 0.026748 | 942 818 | 0.026813 | 602 865 |
| 0.026697 | 802 330 | 0.026749 | 942 820 | 0.026816 | 901 427 |
| 0.026698 | 802 330 | 0.026750 | 942 768 | 0.026817 | 800 366 |
| 0.026699 | 801 360 | 0.026751 | 942 770 | 0.026818 | 802 444 |
| 0.026700 | 801 450 | 0.026752 | 942 619 | 0.026819 | 801 382 |
| 0.026702 | 602 430 | 0.026753 | 951 606 | 0.026820 | 801 376 |
| 0.026703 | 602 539 | 0.026754 | 952 710 | 0.026821 | 800 398 |
| 0.026704 | 602 388 | 0.026755 | 960 578 | 0.026822 | 302 058 |
| 0.026707 | 802 558 | 0.026756 | 962 718 | 0.026823 | 301 132 |
| 0.026708 | 802 542 | 0.026757 | 962 716 | 0.026824 | 101 250 |
| 0.026709 | 802 540 | 0.026758 | 960 702 | 0.026825 | 971 631 |
| 0.026710 | 881 622 | 0.026759 | 602 338 | 0.026826 | 302 248 |



**VERGLEICHNUMMERNLISTE**
**CROSS REFERENCE GUIDE / LISTE DES ÉQUIVALENCES**

| SPIDAN   | OPTIMAL | SPIDAN   | OPTIMAL | SPIDAN        | OPTIMAL        |
|----------|---------|----------|---------|---------------|----------------|
| 0.026827 | 960 578 | 0.026881 | 952 679 | 0.027115      | 100 098        |
| 0.026828 | 961 610 | 0.026882 | 952 676 | 0.027166      | 101 128        |
| 0.026829 | 601 348 | 0.026883 | 952 608 | 0.027167      | 102 207        |
| 0.026830 | 602 344 | 0.026884 | 912 530 | 0.027177      | 102 075        |
| 0.026831 | 602 344 | 0.026885 | 912 423 | 0.027178      | 102 055        |
| 0.026832 | 881 592 | 0.026886 | 911 377 | 0.027187      | 102 041        |
| 0.026833 | 881 594 | 0.026887 | 971 635 | 0.027188      | 100 053        |
| 0.026834 | 882 643 | 0.026888 | 971 641 |               |                |
| 0.026835 | 891 496 | 0.026889 | 972 637 | <b>TIMKEN</b> | <b>OPTIMAL</b> |
| 0.026836 | 892 498 | 0.026890 | 301 118 | EK 73444      | 601 440        |
| 0.026837 | 801 354 | 0.026891 | 302 164 | EK 73444      | 602 418        |
| 0.026839 | 802 732 | 0.026892 | 302 166 | EK 73445      | 602 865        |
| 0.026840 | 190 256 | 0.026893 | 801 554 | EK 73446      | 601 828        |
| 0.026841 | 981 690 | 0.026894 | 802 526 | EK 73447      | 602 416        |
| 0.026843 | 101 128 | 0.026895 | 301 182 | EK 73448      | 602 358        |
| 0.026844 | 100 206 | 0.026896 | 302 188 | EK 73449      | 601 396        |
| 0.026845 | 891 536 | 0.026897 | 302 196 | EK 73450      | 602 815        |
| 0.026846 | 891 466 | 0.026898 | 302 190 | EK 73451      | 602 392        |
| 0.026847 | 892 472 | 0.026899 | 302 186 | EK 73452      | 601 434        |
| 0.026848 | 951 604 | 0.026900 | 301 198 | EK 73453      | 601 502        |
| 0.026849 | 952 678 | 0.026901 | 301 200 | EK 73454      | 602 340        |
| 0.026850 | 302 124 | 0.026902 | 402 143 | EK 73455      | 601 336        |
| 0.026851 | 702 586 | 0.026903 | 202 026 | EK 73456      | 602 414        |
| 0.026853 | 682 492 | 0.026904 | 201 210 | EK 73457      | 681 640        |
| 0.026854 | 682 490 | 0.026905 | 702 309 | EK 73458      | 682 642        |
| 0.026855 | 502 138 | 0.026906 | 702 311 | EK 73459      | 601 495        |
| 0.026856 | 502 148 | 0.026907 | 702 311 | EK 73461      | 601 384        |
| 0.026857 | 401 078 | 0.026908 | 702 313 | EK 73461      | 702 456        |
| 0.026858 | 402 116 | 0.026909 | 702 313 | EK 73462      | 602 859        |
| 0.026859 | 401 082 | 0.026910 | 982 685 | EK 73463      | 602 406        |
| 0.026860 | 402 242 | 0.026911 | 100 022 | EK 73464      | 602 412        |
| 0.026861 | 402 242 | 0.026912 | 302 192 | EK 73465      | 601 654        |
| 0.026862 | 302 260 | 0.026913 | 102 156 | EK 73466      | 602 390        |
| 0.026863 | 202 140 | 0.026914 | 701 307 | EK 73467      | 602 430        |
| 0.026864 | 202 142 | 0.026916 | 100 098 | EK 73468      | 602 539        |
| 0.026865 | 101 024 | 0.026917 | 891 486 | EK 73468      | 602 821        |
| 0.026867 | 102 152 | 0.026918 | 602 314 | EK 73469      | 601 306        |
| 0.026868 | 102 154 | 0.026919 | 981 447 | EK 73470      | 600 308        |
| 0.026870 | 701 307 | 0.026920 | 951 606 | EK 73471      | 601 580        |
| 0.026871 | 100 099 | 0.026976 | 101 111 | EK 73472      | 602 584        |
| 0.026872 | 102 008 | 0.026978 | 100 098 | EK 73474      | 702 817        |
| 0.026874 | 962 548 | 0.026981 | 101 016 | EK 73477      | 702 328        |
| 0.026876 | 960 638 | 0.026988 | 131 129 | EK 73478      | 701 826        |
| 0.026877 | 962 703 | 0.026989 | 132 131 | EK 73479      | 701 404        |
| 0.026878 | 941 700 | 0.027112 | 100 098 | EK 73480      | 702 350        |
| 0.026879 | 942 569 | 0.027113 | 101 113 | EK 73482      | 701 332        |
| 0.026880 | 942 773 | 0.027114 | 100 090 | EK 73483      | 701 432        |
|          |         |          |         | EK 73487      | 701 374        |

## VERGLEICHNUMMERNLISTE

### CROSS REFERENCE GUIDE / LISTE DES ÉQUIVALENCES

| TIMKEN   | OPTIMAL | TIMKEN   | OPTIMAL | TIMKEN   | OPTIMAL |
|----------|---------|----------|---------|----------|---------|
| EK 73490 | 701 302 | EK 73556 | 302 174 | EK 73628 | 802 318 |
| EK 73490 | 701 319 | EK 73556 | 302 176 | EK 73628 | 802 324 |
| EK 73491 | 602 320 | EK 73557 | 301 244 | EK 73630 | 800 304 |
| EK 73492 | 701 326 | EK 73557 | 301 246 | EK 73631 | 801 342 |
| EK 73493 | 701 726 | EK 73558 | 302 120 | EK 73632 | 802 394 |
| EK 73493 | 701 728 | EK 73558 | 302 122 | EK 73634 | 982 650 |
| EK 73494 | 702 436 | EK 73559 | 301 130 | EK 73635 | 982 764 |
| EK 73495 | 702 462 | EK 73561 | 401 028 | EK 73636 | 192 274 |
| EK 73496 | 702 448 | EK 73562 | 401 222 | EK 73637 | 981 790 |
| EK 73499 | 700 310 | EK 73564 | 402 030 | EK 73638 | 981 814 |
| EK 73499 | 701 346 | EK 73566 | 401 277 | EK 73639 | 922 439 |
| EK 73500 | 702 316 | EK 73567 | 401 048 | EK 73639 | 922 799 |
| EK 73501 | 702 380 | EK 73568 | 402 116 | EK 73639 | 952 593 |
| EK 73502 | 702 550 | EK 73577 | 202 252 | EK 73640 | 981 535 |
| EK 73508 | 600 410 | EK 73580 | 302 074 | EK 73644 | 100 056 |
| EK 73511 | 601 446 | EK 73580 | 302 076 | EK 73646 | 191 272 |
| EK 73512 | 501 194 | EK 73582 | 202 236 | EK 73648 | 982 373 |
| EK 73513 | 100 002 | EK 73583 | 202 226 | EK 73649 | 962 682 |
| EK 73514 | 101 147 | EK 73584 | 201 040 | EK 73650 | 982 816 |
| EK 73514 | 942 738 | EK 73586 | 102 103 | EK 73652 | 961 503 |
| EK 73517 | 102 008 | EK 73587 | 101 250 | EK 73652 | 961 792 |
| EK 73518 | 100 036 | EK 73592 | 101 010 | EK 73653 | 962 684 |
| EK 73519 | 501 184 | EK 73597 | 101 044 | EK 73657 | 961 796 |
| EK 73521 | 502 178 | EK 73600 | 102 094 | EK 73661 | 962 517 |
| EK 73522 | 502 134 | EK 73601 | 101 064 | EK 73662 | 962 762 |
| EK 73523 | 501 092 | EK 73602 | 102 054 | EK 73662 | 962 776 |
| EK 73524 | 502 178 | EK 73603 | 101 016 | EK 73663 | 961 883 |
| EK 73526 | 201 032 | EK 73604 | 101 102 | EK 73665 | 962 686 |
| EK 73526 | 971 393 | EK 73605 | 101 108 | EK 73666 | 961 680 |
| EK 73529 | 501 088 | EK 73606 | 102 060 | EK 73667 | 962 760 |
| EK 73529 | 501 112 | EK 73607 | 801 588 | EK 73671 | 912 505 |
| EK 73532 | 501 114 | EK 73608 | 802 652 | EK 73671 | 912 515 |
| EK 73533 | 502 066 | EK 73610 | 802 556 | EK 73673 | 881 879 |
| EK 73534 | 502 070 | EK 73610 | 802 558 | EK 73673 | 911 513 |
| EK 73539 | 301 280 | EK 73611 | 801 238 | EK 73674 | 911 600 |
| EK 73541 | 301 034 | EK 73614 | 801 438 | EK 73677 | 942 788 |
| EK 73541 | 301 038 | EK 73615 | 801 478 | EK 73678 | 941 634 |
| EK 73542 | 300 052 | EK 73616 | 801 372 | EK 73679 | 942 674 |
| EK 73544 | 302 234 | EK 73616 | 802 620 | EK 73680 | 941 786 |
| EK 73545 | 302 046 | EK 73619 | 800 408 | EK 73681 | 942 501 |
| EK 73546 | 300 062 | EK 73620 | 801 922 | EK 73683 | 941 497 |
| EK 73548 | 301 230 | EK 73621 | 801 574 | EK 73684 | 941 873 |
| EK 73549 | 301 232 | EK 73622 | 801 402 | EK 73685 | 941 511 |
| EK 73552 | 302 162 | EK 73623 | 801 698 | EK 73686 | 942 754 |
| EK 73553 | 301 018 | EK 73624 | 802 480 | EK 73687 | 952 832 |
| EK 73554 | 301 006 | EK 73625 | 802 464 | EK 73688 | 920 752 |
| EK 73556 | 302 172 | EK 73626 | 801 538 | EK 73689 | 951 756 |

**VERGLEICHNUMMERNLISTE**
**CROSS REFERENCE GUIDE / LISTE DES ÉQUIVALENCES**

| TIMKEN   | OPTIMAL | TIMKEN   | OPTIMAL | TIMKEN   | OPTIMAL |
|----------|---------|----------|---------|----------|---------|
| EK 73690 | 951 519 | EK 73797 | 200 012 | EK 74232 | 301 180 |
| EK 73691 | 952 679 | EK 73797 | 972 389 | EK 74234 | 302 240 |
| EK 73692 | 951 606 | EK 73800 | 682 920 | EK 74235 | 911 782 |
| EK 73702 | 892 830 | EK 73802 | 912 530 | EK 74236 | 801 656 |
| EK 73703 | 892 670 | EK 73803 | 881 489 | EK 74237 | 802 590 |
| EK 73703 | 892 806 | EK 73804 | 882 491 | EK 74238 | 801 442 |
| EK 73705 | 892 460 | EK 73805 | 882 611 | EK 74239 | 802 658 |
| EK 73706 | 891 822 | EK 73805 | 882 613 | EK 74240 | 941 636 |
| EK 73707 | 911 600 | EK 73807 | 891 546 | EK 74240 | 941 874 |
| EK 73708 | 892 804 | EK 73808 | 892 476 | EK 74242 | 201 084 |
| EK 73709 | 891 520 | EK 73809 | 981 742 | EK 74243 | 202 026 |
| EK 73709 | 891 522 | EK 73811 | 202 065 | EK 74244 | 202 168 |
| EK 73710 | 892 458 | EK 73812 | 971 567 | EK 74247 | 602 338 |
| EK 73711 | 802 454 | EK 73813 | 972 573 | EK 74248 | 891 484 |
| EK 73715 | 802 720 | EK 73814 | 102 008 | EK 74250 | 891 482 |
| EK 73716 | 801 618 | EK 73815 | 101 110 | EK 74251 | 892 468 |
| EK 73725 | 200 020 | EK 73816 | 882 643 | EK 74252 | 960 578 |
| EK 73726 | 882 819 | EK 73817 | 681 907 | EK 74253 | 962 718 |
| EK 73727 | 882 863 | EK 73818 | 961 808 | EK 74254 | 602 388 |
| EK 73728 | 880 525 | EK 73819 | 942 566 | EK 74255 | 100 022 |
| EK 73729 | 881 592 | EK 73820 | 681 504 | EK 74256 | 100 090 |
| EK 73731 | 881 527 | EK 73821 | 682 420 | EK 74256 | 100 091 |
| EK 73741 | 681 919 | EK 73821 | 682 422 | EK 74256 | 100 093 |
| EK 73743 | 880 525 | EK 73824 | 682 920 | EK 74256 | 102 041 |
| EK 73744 | 881 507 | EK 73831 | 300 004 | EK 74257 | 100 098 |
| EK 73745 | 882 598 | EK 73836 | 801 554 | EK 74258 | 502 072 |
| EK 73747 | 882 875 | EK 73837 | 300 062 | EK 74259 | 501 170 |
| EK 73748 | 881 622 | EK 73839 | 302 208 | EK 74261 | 922 395 |
| EK 73749 | 882 664 | EK 73840 | 881 594 | EK 74261 | 952 710 |
| EK 73750 | 881 609 | EK 73841 | 102 150 | EK 74262 | 922 557 |
| EK 73752 | 912 471 | EK 73842 | 302 160 | EK 74262 | 972 793 |
| EK 73758 | 882 666 | EK 74209 | 600 334 | EK 74265 | 401 042 |
| EK 73759 | 880 493 | EK 74210 | 602 322 | EK 74266 | 942 568 |
| EK 73759 | 881 564 | EK 74211 | 892 474 | EK 74266 | 942 570 |
| EK 73762 | 881 529 | EK 74212 | 892 802 | EK 74267 | 102 266 |
| EK 73763 | 882 531 | EK 74213 | 961 576 | EK 74267 | 102 268 |
| EK 73764 | 880 812 | EK 74214 | 881 594 | EK 74268 | 101 270 |
| EK 73767 | 881 871 | EK 74215 | 801 500 | EK 74269 | 101 264 |
| EK 73772 | 882 861 | EK 74219 | 802 560 | EK 74271 | 802 540 |
| EK 73776 | 881 523 | EK 74220 | 802 562 | EK 74271 | 802 542 |
| EK 73787 | 682 911 | EK 74221 | 800 400 | EK 74275 | 901 427 |
| EK 73787 | 682 921 | EK 74222 | 802 370 | EK 74275 | 901 461 |
| EK 73791 | 102 266 | EK 74223 | 802 368 | EK 74276 | 902 457 |
| EK 73792 | 802 488 | EK 74224 | 801 450 | EK 74278 | 942 768 |
| EK 73792 | 802 646 | EK 74225 | 801 360 | EK 74278 | 942 770 |
| EK 73795 | 202 202 | EK 74227 | 911 623 | EK 74279 | 401 126 |
| EK 73796 | 202 204 | EK 74231 | 702 692 | EK 74280 | 401 096 |

## VERGLEICHNUMMERNLISTE

### CROSS REFERENCE GUIDE / LISTE DES ÉQUIVALENCES

| TIMKEN   | OPTIMAL | TIMKEN   | OPTIMAL | TIMKEN   | OPTIMAL |
|----------|---------|----------|---------|----------|---------|
| EK 74281 | 981 616 | EK 74340 | 301 132 | EK 78584 | 941 647 |
| EK 74282 | 901 445 | EK 74341 | 302 058 | EK 78585 | 931 649 |
| EK 74283 | 941 565 | EK 74342 | 702 312 | EK 78586 | 942 651 |
| EK 74284 | 881 704 | EK 74343 | 302 248 | EK 78587 | 982 653 |
| EK 74285 | 912 532 | EK 74344 | 302 124 | EK 78588 | 981 655 |
| EK 74286 | 882 624 | EK 74345 | 912 471 | EK 78589 | 951 657 |
| EK 74287 | 951 708 | EK 74346 | 402 050 | EK 78590 | 951 659 |
| EK 74288 | 952 661 | EK 74347 | 801 354 | EK 78592 | 952 577 |
| EK 74289 | 911 375 | EK 74349 | 801 543 | EK 78593 | 901 890 |
| EK 74290 | 942 672 | EK 74349 | 801 694 | EK 78594 | 902 891 |
| EK 74291 | 601 348 | EK 74350 | 802 732 | EK 78595 | 902 901 |
| EK 74292 | 602 356 | EK 74354 | 801 376 | EK 78596 | 902 897 |
| EK 74293 | 960 702 | EK 74355 | 681 506 | EK 78597 | 191 258 |
| EK 74294 | 962 716 | EK 74356 | 801 428 | EK 78598 | 682 508 |
| EK 74298 | 912 473 | EK 74357 | 800 366 | EK 78599 | 682 510 |
| EK 74299 | 940 632 | EK 74358 | 802 444 | EK 78603 | 601 582 |
| EK 74300 | 931 877 | EK 74360 | 801 382 | EK 78604 | 602 512 |
| EK 74301 | 941 602 | EK 74362 | 802 740 | EK 78611 | 802 528 |
| EK 74302 | 942 818 | EK 74390 | 971 615 | EK 78613 | 501 136 |
| EK 74302 | 942 820 | EK 74391 | 972 633 | EK 78614 | 502 138 |
| EK 74303 | 202 205 | EK 74394 | 401 100 | EK 78615 | 502 148 |
| EK 74303 | 932 794 | EK 74395 | 401 104 | EK 78616 | 502 068 |
| EK 74307 | 702 352 | EK 74396 | 891 496 | EK 78617 | 602 314 |
| EK 74309 | 602 344 | EK 74397 | 892 498 | EK 78618 | 682 492 |
| EK 74310 | 702 514 | EK 74401 | 971 627 | EK 78619 | 682 490 |
| EK 74311 | 911 625 | EK 74402 | 911 629 | EK 78620 | 901 429 |
| EK 74312 | 952 758 | EK 78562 | 971 631 | EK 78621 | 901 425 |
| EK 74313 | 981 572 | EK 78563 | 972 465 | EK 78622 | 902 443 |
| EK 74315 | 941 617 | EK 78564 | 971 635 | EK 78623 | 922 441 |
| EK 74317 | 981 744 | EK 78565 | 972 637 | EK 78624 | 901 895 |
| EK 74318 | 902 459 | EK 78566 | 972 639 | EK 78624 | 901 896 |
| EK 74319 | 982 778 | EK 78567 | 971 641 | EK 78625 | 901 885 |
| EK 74320 | 982 780 | EK 78568 | 891 536 | EK 78626 | 901 549 |
| EK 74322 | 402 080 | EK 78569 | 891 466 | EK 78626 | 931 681 |
| EK 74323 | 702 452 | EK 78570 | 892 472 | EK 78627 | 931 697 |
| EK 74324 | 702 552 | EK 78571 | 401 137 | EK 78628 | 922 797 |
| EK 74326 | 801 644 | EK 78572 | 931 663 | EK 78629 | 902 900 |
| EK 74326 | 801 750 | EK 78573 | 932 665 | EK 78630 | 802 526 |
| EK 74327 | 802 748 | EK 78574 | 982 581 | EK 78631 | 941 700 |
| EK 74330 | 961 801 | EK 78575 | 982 800 | EK 78632 | 942 569 |
| EK 74331 | 961 765 | EK 78576 | 981 798 | EK 78633 | 301 198 |
| EK 74331 | 962 435 | EK 78577 | 932 667 | EK 78633 | 301 200 |
| EK 74332 | 962 601 | EK 78578 | 190 256 | EK 78634 | 301 182 |
| EK 74333 | 981 747 | EK 78579 | 931 669 | EK 78635 | 302 186 |
| EK 74334 | 982 749 | EK 78580 | 981 690 | EK 78636 | 302 188 |
| EK 74337 | 882 626 | EK 78581 | 981 579 | EK 78637 | 302 190 |
| EK 74339 | 802 378 | EK 78582 | 951 722 | EK 78638 | 302 037 |

## VERGLEICHNUMMERNLISTE

### CROSS REFERENCE GUIDE / LISTE DES ÉQUIVALENCES

| TIMKEN   | OPTIMAL | TIMKEN   | OPTIMAL | TIMKEN   | OPTIMAL |
|----------|---------|----------|---------|----------|---------|
| EK 78638 | 302 192 | EK 78682 | 102 154 | EK 78764 | 962 413 |
| EK 78639 | 302 196 | EK 78683 | 102 156 | EK 78765 | 891 706 |
| EK 78640 | 302 260 | EK 78684 | 891 486 | EK 78766 | 891 524 |
| EK 78641 | 301 118 | EK 78685 | 901 427 | EK 78767 | 201 228 |
| EK 78642 | 302 164 | EK 78688 | 961 724 | EK 78768 | 801 364 |
| EK 78643 | 302 166 | EK 78689 | 941 734 | EK 78769 | 801 362 |
| EK 78644 | 942 619 | EK 78689 | 942 738 | EK 78770 | 800 398 |
| EK 78645 | 952 676 | EK 78690 | 961 479 | EK 78771 | 802 330 |
| EK 78646 | 952 678 | EK 78691 | 962 481 | EK 78772 | 701 307 |
| EK 78647 | 891 731 | EK 78699 | 962 703 | EK 78773 | 702 357 |
| EK 78647 | 951 604 | EK 78700 | 962 705 | EK 78774 | 702 355 |
| EK 78647 | 991 902 | EK 78704 | 961 753 | EK 78775 | 702 353 |
| EK 78648 | 952 608 | EK 78705 | 962 949 | EK 78776 | 702 426 |
| EK 78651 | 951 449 | EK 78706 | 201 210 | EK 78777 | 882 729 |
| EK 78652 | 961 610 | EK 78708 | 702 311 | EK 78777 | 912 775 |
| EK 78653 | 962 548 | EK 78710 | 702 309 | EK 78778 | 702 537 |
| EK 78654 | 962 603 | EK 78712 | 702 313 | EK 78779 | 702 365 |
| EK 78654 | 962 841 | EK 78713 | 701 424 | EK 78780 | 892 733 |
| EK 78654 | 962 899 | EK 78714 | 882 463 | EK 78781 | 911 383 |
| EK 78654 | 962 905 | EK 78717 | 971 723 | EK 78782 | 101 016 |
| EK 78655 | 961 904 | EK 78718 | 972 453 | EK 78784 | 681 506 |
| EK 78656 | 961 411 | EK 78719 | 972 699 | EK 78785 | 682 327 |
| EK 78657 | 202 140 | EK 78720 | 982 431 | EK 78786 | 681 325 |
| EK 78658 | 202 142 | EK 78720 | 982 766 | EK 78787 | 682 329 |
| EK 78658 | 972 397 | EK 78723 | 981 407 | EK 78788 | 880 419 |
| EK 78659 | 201 262 | EK 78724 | 982 379 | EK 78790 | 942 381 |
| EK 78660 | 702 494 | EK 78729 | 981 475 | EK 78791 | 892 470 |
| EK 78662 | 702 363 | EK 78734 | 100 014 | EK 78792 | 972 709 |
| EK 78664 | 702 586 | EK 78735 | 682 892 | EK 78793 | 941 687 |
| EK 78667 | 971 455 | EK 78741 | 962 853 | EK 78794 | 401 212 |
| EK 78668 | 972 453 | EK 78742 | 401 214 | EK 78795 | 941 563 |
| EK 78668 | 972 719 | EK 78743 | 402 216 | EK 78796 | 891 630 |
| EK 78668 | 972 721 | EK 78744 | 401 078 | EK 78797 | 202 218 |
| EK 78669 | 971 455 | EK 78745 | 401 082 | EK 78798 | 961 648 |
| EK 78670 | 971 575 | EK 78746 | 101 128 | EK 78799 | 962 712 |
| EK 78670 | 971 711 | EK 78746 | 101 209 | EK 78800 | 962 714 |
| EK 78671 | 971 451 | EK 78747 | 100 206 | EK 78801 | 942 736 |
| EK 78672 | 972 571 | EK 78748 | 911 377 | EK 78802 | 891 544 |
| EK 78673 | 971 612 | EK 78748 | 911 777 | EK 78803 | 891 628 |
| EK 78674 | 972 688 | EK 78751 | 101 044 | EK 78804 | 681 303 |
| EK 78675 | 961 675 | EK 78752 | 960 638 | EK 78805 | 682 305 |
| EK 78676 | 962 605 | EK 78753 | 911 385 | EK 78806 | 981 849 |
| EK 78677 | 981 683 | EK 78754 | 911 387 | EK 78807 | 982 559 |
| EK 78678 | 981 447 | EK 78755 | 882 727 | EK 78808 | 981 851 |
| EK 78679 | 982 685 | EK 78757 | 911 621 | EK 78809 | 982 561 |
| EK 78680 | 101 024 | EK 78758 | 981 944 | EK 78810 | 982 437 |
| EK 78681 | 102 152 | EK 78762 | 941 862 | EK 78811 | 971 707 |

## VERGLEICHNUMMERNLISTE

### CROSS REFERENCE GUIDE / LISTE DES ÉQUIVALENCES

| TIMKEN   | OPTIMAL | TIMKEN   | OPTIMAL | TIMKEN   | OPTIMAL |
|----------|---------|----------|---------|----------|---------|
| EK 78813 | 971 391 | EK 78896 | 602 347 | EK 78966 | 982 762 |
| EK 78815 | 880 421 | EK 78897 | 602 349 | EK 78968 | 892 843 |
| EK 78816 | 941 673 | EK 78900 | 802 485 | EK 78969 | 982 737 |
| EK 78819 | 801 730 | EK 78901 | 802 335 | EK 78970 | 100 053 |
| EK 78820 | 892 735 | EK 78902 | 101 113 | EK 78971 | 802 886 |
| EK 78821 | 891 333 | EK 78903 | 102 115 | EK 78973 | 202 153 |
| EK 78822 | 101 111 | EK 78904 | 501 121 | EK 78976 | 202 155 |
| EK 78831 | 942 671 | EK 78905 | 502 123 | EK 78977 | 801 836 |
| EK 78832 | 402 143 | EK 78906 | 502 125 | EK 78978 | 400 051 |
| EK 78833 | 402 242 | EK 78907 | 971 791 | EK 78988 | 102 055 |
| EK 78835 | 982 431 | EK 78908 | 971 795 | EK 78990 | 982 774 |
| EK 78836 | 980 614 | EK 78909 | 902 771 | EK 78991 | 891 869 |
| EK 78838 | 941 784 | EK 78910 | 902 547 | EK 78992 | 991 946 |
| EK 78840 | 962 847 | EK 78911 | 902 855 | EK 78995 | 400 107 |
| EK 78842 | 941 689 | EK 78921 | 922 783 | EK 78996 | 891 477 |
| EK 78844 | 942 693 | EK 78922 | 922 781 | EK 78997 | 891 469 |
| EK 78845 | 942 695 | EK 78923 | 922 854 | EK 78998 | 102 011 |
| EK 78847 | 501 133 | EK 78924 | 921 553 | EK 78999 | 601 323 |
| EK 78848 | 502 135 | EK 78925 | 922 787 | EK 79000 | 702 321 |
| EK 78853 | 911 377 | EK 78926 | 922 789 | EK 79002 | 702 866 |
| EK 78855 | 912 401 | EK 78927 | 921 555 | EK 79003 | 981 499 |
| EK 78856 | 912 545 | EK 78929 | 802 331 | EK 79004 | 981 533 |
| EK 78857 | 911 399 | EK 78930 | 942 773 | EK 79005 | 981 868 |
| EK 78858 | 912 403 | EK 78933 | 402 117 | EK 79006 | 982 857 |
| EK 78861 | 941 951 | EK 78934 | 402 119 | EK 79007 | 981 763 |
| EK 78862 | 602 367 | EK 78935 | 952 405 | EK 79008 | 982 811 |
| EK 78864 | 961 701 | EK 78936 | 952 415 | EK 79009 | 982 813 |
| EK 78866 | 702 351 | EK 78937 | 952 551 | EK 79010 | 802 870 |
| EK 78868 | 702 359 | EK 78938 | 952 417 | EK 79011 | 502 109 |
| EK 78869 | 131 129 | EK 78939 | 952 769 | EK 79016 | 801 838 |
| EK 78870 | 132 131 | EK 78942 | 951 409 | EK 79017 | 941 840 |
| EK 78871 | 301 139 | EK 78943 | 962 757 | EK 79026 | 880 912 |
| EK 78871 | 301 141 | EK 78944 | 961 903 | EK 79033 | 981 856 |
| EK 78873 | 602 339 | EK 78945 | 961 759 | EK 79036 | 982 884 |
| EK 78873 | 602 341 | EK 78946 | 962 755 | EK 79039 | 971 917 |
| EK 78874 | 802 315 | EK 78947 | 961 751 | EK 79040 | 702 850 |
| EK 78875 | 602 337 | EK 78948 | 962 767 | EK 79041 | 972 918 |
| EK 78879 | 962 779 | EK 78949 | 602 369 | EK 79046 | 802 888 |
| EK 78880 | 981 805 | EK 78952 | 882 487 | EK 79050 | 932 864 |
| EK 78882 | 992 894 | EK 78953 | 881 725 | EK 79051 | 401 047 |
| EK 78886 | 912 423 | EK 78954 | 882 483 | EK 79052 | 402 063 |
| EK 78888 | 940 371 | EK 78956 | 972 717 | EK 79059 | 301 039 |
| EK 78889 | 962 810 | EK 78958 | 972 715 | EK 79060 | 302 057 |
| EK 78892 | 602 341 | EK 78962 | 981 743 | EK 79063 | 912 803 |
| EK 78893 | 602 345 | EK 78963 | 981 745 | EK 79065 | 981 947 |
| EK 78894 | 602 361 | EK 78964 | 982 379 | EK 79066 | 982 948 |
| EK 78895 | 602 343 | EK 78965 | 982 379 | EK 79067 | 981 938 |

**VERGLEICHNUMMERNLISTE**
**CROSS REFERENCE GUIDE / LISTE DES ÉQUIVALENCES**

| TIMKEN   | OPTIMAL | TIMKEN  | OPTIMAL | TIMKEN  | OPTIMAL |
|----------|---------|---------|---------|---------|---------|
| EK 79068 | 982 939 | K 80127 | 802 886 | K 80331 | 912 803 |
| EK 79072 | 702 312 | K 80128 | 802 870 | K 80332 | 912 423 |
| EK 79073 | 701 860 | K 80201 | 100 036 | K 80333 | 912 775 |
| EK 79074 | 702 846 | K 80202 | 102 008 | K 80350 | 681 919 |
| EK 79075 | 701 852 | K 80203 | 100 002 | K 80352 | 682 921 |
| EK 79078 | 801 950 | K 80204 | 100 014 | K 80353 | 682 920 |
| EK 79084 | 891 878 | K 80205 | 100 056 | K 80355 | 681 907 |
| EK 79085 | 892 872 | K 80207 | 100 090 | K 80401 | 971 391 |
| EK 79086 | 201 033 | K 80208 | 101 111 | K 80402 | 971 393 |
| EK 79087 | 201 035 | K 80211 | 101 147 | K 80403 | 972 389 |
| EK 79088 | 201 031 | K 80212 | 101 113 | K 80404 | 972 397 |
| EK 79089 | 201 043 | K 80213 | 102 115 | K 80501 | 501 194 |
| EK 79090 | 202 059 | K 80214 | 100 098 | K 80502 | 502 134 |
| EK 79091 | 400 061 | K 80214 | 100 099 | K 80503 | 501 184 |
| EK 79092 | 801 880 | K 80215 | 102 055 | K 80505 | 502 178 |
| EK 79093 | 601 916 | K 80216 | 102 041 | K 80506 | 501 088 |
| EK 79094 | 602 858 | K 80217 | 100 053 | K 80507 | 502 068 |
| EK 79100 | 301 045 | K 80301 | 881 507 | K 80508 | 501 114 |
| EK 79106 | 502 125 | K 80302 | 882 598 | K 80509 | 502 070 |
| EK 79107 | 991 898 | K 80303 | 881 622 | K 80510 | 501 112 |
| EK 79117 | 802 839 | K 80304 | 882 664 | K 80511 | 502 072 |
| EK 79127 | 302 067 | K 80306 | 880 525 | K 80512 | 502 158 |
| EK 79134 | 891 887 | K 80307 | 881 507 | K 80513 | 501 114 |
| EK 79139 | 701 914 | K 80308 | 881 534 | K 80514 | 502 066 |
| K 80101  | 801 588 | K 80308 | 881 594 | K 80515 | 501 170 |
| K 80102  | 802 652 | K 80309 | 911 600 | K 80516 | 501 136 |
| K 80103  | 981 535 | K 80310 | 881 704 | K 80517 | 502 138 |
| K 80104  | 801 438 | K 80311 | 912 471 | K 80518 | 502 148 |
| K 80105  | 802 556 | K 80312 | 912 530 | K 80519 | 501 092 |
| K 80106  | 801 478 | K 80313 | 912 532 | K 80520 | 501 121 |
| K 80107  | 962 776 | K 80314 | 882 626 | K 80521 | 502 123 |
| K 80108  | 802 542 | K 80315 | 882 624 | K 80522 | 502 125 |
| K 80112  | 802 560 | K 80316 | 881 609 | K 80523 | 502 135 |
| K 80113  | 801 554 | K 80317 | 882 611 | K 80524 | 501 133 |
| K 80114  | 802 558 | K 80318 | 882 613 | K 80525 | 502 135 |
| K 80115  | 802 540 | K 80319 | 882 643 | K 80526 | 502 109 |
| K 80116  | 801 428 | K 80320 | 882 463 | K 80601 | 901 461 |
| K 80117  | 802 528 | K 80321 | 882 487 | K 80602 | 902 459 |
| K 80118  | 802 488 | K 80322 | 882 483 | K 80603 | 902 457 |
| K 80119  | 801 500 | K 80323 | 881 725 | K 80604 | 901 429 |
| K 80120  | 802 562 | K 80324 | 882 727 | K 80605 | 901 425 |
| K 80121  | 802 335 | K 80325 | 882 729 | K 80606 | 901 427 |
| K 80122  | 802 485 | K 80326 | 911 385 | K 80607 | 901 549 |
| K 80123  | 801 836 | K 80327 | 911 387 | K 80608 | 902 443 |
| K 80124  | 801 838 | K 80328 | 911 377 | K 80609 | 901 445 |
| K 80125  | 802 839 | K 80329 | 911 383 | K 80610 | 902 855 |
| K 80126  | 802 888 | K 80330 | 882 607 | K 80611 | 902 906 |

## VERGLEICHNUMMERNLISTE

### CROSS REFERENCE GUIDE / LISTE DES ÉQUIVALENCES

| TIMKEN  | OPTIMAL | TIMKEN  | OPTIMAL | TIMKEN  | OPTIMAL |
|---------|---------|---------|---------|---------|---------|
| K 80701 | 601 440 | K 81106 | 302 234 | K 81158 | 302 164 |
| K 80702 | 602 418 | K 81107 | 301 280 | K 81159 | 302 166 |
| K 80703 | 602 865 | K 81108 | 302 254 | K 81201 | 951 606 |
| K 80705 | 601 828 | K 81109 | 301 034 | K 81202 | 922 441 |
| K 80706 | 602 416 | K 81110 | 302 046 | K 81203 | 922 783 |
| K 80708 | 602 414 | K 81110 | 302 074 | K 81204 | 922 781 |
| K 80709 | 601 502 | K 81111 | 301 006 | K 81205 | 922 439 |
| K 80710 | 601 336 | K 81112 | 301 232 | K 81206 | 920 752 |
| K 80712 | 602 320 | K 81113 | 302 146 | K 81207 | 951 722 |
| K 80716 | 602 358 | K 81114 | 301 244 | K 81208 | 952 661 |
| K 80717 | 601 434 | K 81114 | 301 246 | K 81209 | 951 708 |
| K 80718 | 600 334 | K 81115 | 302 120 | K 81210 | 952 758 |
| K 80719 | 602 322 | K 81115 | 302 122 | K 81211 | 952 710 |
| K 80720 | 601 348 | K 81116 | 301 180 | K 81212 | 952 678 |
| K 80721 | 602 356 | K 81117 | 302 058 | K 81213 | 951 409 |
| K 80722 | 602 314 | K 81118 | 301 038 | K 81214 | 952 405 |
| K 80723 | 602 388 | K 81119 | 302 076 | K 81215 | 952 676 |
| K 80724 | 681 303 | K 81120 | 301 132 | K 81216 | 952 551 |
| K 80725 | 682 305 | K 81121 | 302 248 | K 81217 | 952 769 |
| K 80727 | 602 392 | K 81122 | 301 130 | K 81218 | 951 449 |
| K 80728 | 602 337 | K 81123 | 302 260 | K 81219 | 951 604 |
| K 80729 | 602 345 | K 81124 | 301 198 | K 81220 | 952 415 |
| K 80730 | 602 339 | K 81124 | 301 200 | K 81221 | 952 417 |
| K 80731 | 602 341 | K 81125 | 301 182 | K 81222 | 952 608 |
| K 80732 | 602 347 | K 81126 | 302 186 | K 81223 | 952 593 |
| K 80733 | 602 349 | K 81127 | 302 188 | K 81701 | 801 372 |
| K 80734 | 601 323 | K 81128 | 302 190 | K 81701 | 802 620 |
| K 80735 | 602 386 | K 81129 | 302 192 | K 81702 | 802 331 |
| K 80737 | 602 858 | K 81130 | 302 196 | K 81801 | 801 442 |
| K 80738 | 602 926 | K 81131 | 302 208 | K 81802 | 802 454 |
| K 80750 | 681 504 | K 81132 | 302 240 | K 81803 | 802 658 |
| K 80751 | 682 420 | K 81133 | 301 139 | K 81850 | 801 656 |
| K 80751 | 682 422 | K 81134 | 301 141 | K 81851 | 802 590 |
| K 80752 | 681 640 | K 81135 | 131 129 | K 81901 | 942 768 |
| K 80753 | 682 642 | K 81136 | 132 131 | K 81902 | 942 770 |
| K 80754 | 681 506 | K 81137 | 302 067 | K 81903 | 941 636 |
| K 80755 | 681 325 | K 81138 | 302 037 | K 81904 | 940 632 |
| K 80756 | 682 327 | K 81139 | 301 039 | K 81905 | 941 700 |
| K 80757 | 682 329 | K 81140 | 301 045 | K 81906 | 940 371 |
| K 80758 | 681 923 | K 81141 | 302 057 | K 81907 | 942 569 |
| K 80759 | 682 925 | K 81150 | 300 062 | K 81908 | 942 773 |
| K 80760 | 681 924 | K 81151 | 302 172 | K 81909 | 942 381 |
| K 81101 | 301 230 | K 81153 | 302 162 | K 81910 | 941 602 |
| K 81102 | 300 052 | K 81154 | 302 174 | K 81911 | 942 672 |
| K 81103 | 301 018 | K 81155 | 302 124 | K 81912 | 941 842 |
| K 81104 | 300 004 | K 81156 | 302 176 | K 81912 | 941 951 |
| K 81105 | 300 004 | K 81157 | 301 118 | K 81913 | 941 840 |



## VERGLEICHNUMMERNLISTE

### CROSS REFERENCE GUIDE / LISTE DES ÉQUIVALENCES

| TIMKEN  | OPTIMAL | TIMKEN  | OPTIMAL | TIMKEN  | OPTIMAL |
|---------|---------|---------|---------|---------|---------|
| K 81914 | 941 862 | K 82350 | 961 904 | K 82613 | 601 306 |
| K 82001 | 401 222 | K 82351 | 962 899 | K 82615 | 600 308 |
| K 82002 | 402 030 | K 82352 | 961 503 | K 82616 | 602 340 |
| K 82003 | 401 028 | K 82352 | 961 724 | K 82617 | 602 338 |
| K 82004 | 401 277 | K 82352 | 961 792 | K 82618 | 602 344 |
| K 82005 | 402 116 | K 82353 | 962 684 | K 82619 | 601 916 |
| K 82006 | 401 042 | K 82361 | 961 411 | K 82620 | 602 645 |
| K 82007 | 402 080 | K 82362 | 962 413 | K 82621 | 602 927 |
| K 82008 | 401 126 | K 82363 | 962 841 | K 82650 | 601 580 |
| K 82009 | 401 048 | K 82364 | 962 905 | K 82652 | 602 369 |
| K 82010 | 401 096 | K 82365 | 962 913 | K 82653 | 602 367 |
| K 82011 | 401 078 | K 82501 | 201 040 | K 82654 | 602 361 |
| K 82012 | 401 082 | K 82502 | 200 012 | K 82655 | 602 343 |
| K 82013 | 402 242 | K 82503 | 202 252 | K 82903 | 701 826 |
| K 82014 | 400 061 | K 82504 | 200 020 | K 82904 | 702 350 |
| K 82015 | 401 047 | K 82506 | 201 032 | K 82904 | 702 817 |
| K 82016 | 402 063 | K 82506 | 202 026 | K 82907 | 701 374 |
| K 82017 | 400 051 | K 82507 | 202 226 | K 82908 | 701 332 |
| K 82050 | 401 100 | K 82508 | 202 236 | K 82909 | 702 328 |
| K 82051 | 401 137 | K 82509 | 202 202 | K 82910 | 701 432 |
| K 82053 | 402 050 | K 82510 | 201 084 | K 82911 | 701 302 |
| K 82057 | 402 216 | K 82511 | 202 204 | K 82912 | 702 312 |
| K 82058 | 401 214 | K 82512 | 202 168 | K 82913 | 701 326 |
| K 82063 | 402 143 | K 82513 | 202 140 | K 82914 | 701 404 |
| K 82064 | 401 212 | K 82516 | 201 210 | K 82915 | 702 316 |
| K 82065 | 402 119 | K 82517 | 202 142 | K 82916 | 702 380 |
| K 82066 | 401 137 | K 82518 | 201 228 | K 82917 | 700 310 |
| K 82067 | 402 117 | K 82519 | 202 218 | K 82918 | 702 426 |
| K 82068 | 400 107 | K 82520 | 201 262 | K 82920 | 702 514 |
| K 82301 | 961 610 | K 82521 | 972 573 | K 82921 | 701 302 |
| K 82302 | 962 548 | K 82522 | 971 567 | K 82921 | 701 319 |
| K 82304 | 962 481 | K 82523 | 201 033 | K 82923 | 702 352 |
| K 82305 | 961 796 | K 82524 | 201 035 | K 82925 | 702 552 |
| K 82306 | 962 682 | K 82525 | 201 031 | K 82926 | 702 494 |
| K 82307 | 960 638 | K 82526 | 201 043 | K 82927 | 701 346 |
| K 82308 | 962 703 | K 82527 | 202 059 | K 82930 | 702 311 |
| K 82309 | 962 705 | K 82528 | 202 218 | K 82931 | 701 307 |
| K 82310 | 961 701 | K 82529 | 201 087 | K 82932 | 702 452 |
| K 82311 | 960 578 | K 82530 | 202 224 | K 82933 | 702 550 |
| K 82312 | 962 718 | K 82602 | 602 815 | K 82934 | 702 313 |
| K 82313 | 962 716 | K 82604 | 601 495 | K 82936 | 702 357 |
| K 82314 | 960 702 | K 82605 | 602 541 | K 82937 | 702 355 |
| K 82315 | 961 648 | K 82606 | 602 859 | K 82938 | 702 353 |
| K 82317 | 962 714 | K 82609 | 602 412 | K 82939 | 702 351 |
| K 82318 | 962 712 | K 82610 | 601 384 | K 82940 | 702 915 |
| K 82319 | 961 479 | K 82611 | 602 406 | K 82941 | 702 359 |
| K 82320 | 961 680 | K 82612 | 602 390 | K 82942 | 702 363 |

## VERGLEICHNUMMERNLISTE

### CROSS REFERENCE GUIDE / LISTE DES ÉQUIVALENCES

| TIMKEN  | OPTIMAL | TIMKEN  | OPTIMAL | TIMKEN  | OPTIMAL |
|---------|---------|---------|---------|---------|---------|
| K 82943 | 702 365 | K 83215 | 802 394 | K 83605 | 601 654 |
| K 82945 | 701 852 | K 83216 | 800 400 | K 83703 | 982 379 |
| K 82946 | 702 537 | K 83217 | 802 330 | K 83705 | 982 766 |
| K 82947 | 702 866 | K 83219 | 802 368 | K 83706 | 980 614 |
| K 82949 | 702 321 | K 83220 | 801 450 | K 83707 | 981 475 |
| K 82950 | 701 726 | K 83221 | 801 360 | K 83708 | 982 431 |
| K 82951 | 702 436 | K 83222 | 802 370 | K 83709 | 982 431 |
| K 82952 | 701 424 | K 83223 | 802 330 | K 83710 | 981 790 |
| K 82953 | 702 462 | K 83224 | 802 378 | K 83711 | 982 650 |
| K 82954 | 702 448 | K 83225 | 800 366 | K 83712 | 982 373 |
| K 82955 | 702 456 | K 83226 | 801 376 | K 83713 | 982 437 |
| K 82956 | 702 692 | K 83227 | 800 398 | K 83714 | 982 737 |
| K 82957 | 701 728 | K 83228 | 802 324 | K 83715 | 981 745 |
| K 82958 | 702 586 | K 83229 | 802 444 | K 83716 | 981 743 |
| K 82959 | 701 860 | K 83231 | 802 526 | K 83717 | 982 379 |
| K 82960 | 702 846 | K 83234 | 801 730 | K 83718 | 982 379 |
| K 82961 | 702 309 | K 83235 | 801 364 | K 83719 | 982 778 |
| K 82962 | 701 307 | K 83236 | 801 362 | K 83720 | 982 780 |
| K 82964 | 702 850 | K 83237 | 802 315 | K 83721 | 981 690 |
| K 82965 | 702 312 | K 83238 | 801 880 | K 83722 | 981 747 |
| K 82966 | 701 914 | K 83252 | 801 644 | K 83724 | 981 744 |
| K 83050 | 880 812 | K 83252 | 801 750 | K 83725 | 982 816 |
| K 83053 | 880 419 | K 83253 | 802 748 | K 83726 | 982 561 |
| K 83054 | 880 421 | K 83257 | 682 508 | K 83727 | 981 742 |
| K 83055 | 880 912 | K 83257 | 682 510 | K 83728 | 981 851 |
| K 83101 | 801 618 | K 83259 | 682 490 | K 83729 | 981 856 |
| K 83102 | 802 720 | K 83259 | 682 492 | K 83730 | 981 868 |
| K 83103 | 801 694 | K 83261 | 802 740 | K 83731 | 982 857 |
| K 83104 | 802 732 | K 83263 | 681 909 | K 83733 | 982 762 |
| K 83105 | 102 266 | K 83264 | 681 910 | K 83734 | 981 763 |
| K 83105 | 801 543 | K 83401 | 971 455 | K 83750 | 190 256 |
| K 83106 | 801 694 | K 83402 | 972 453 | K 83751 | 982 581 |
| K 83107 | 102 077 | K 83403 | 971 575 | K 83752 | 981 579 |
| K 83108 | 101 025 | K 83404 | 971 711 | K 83753 | 981 814 |
| K 83109 | 101 027 | K 83405 | 972 719 | K 83754 | 981 447 |
| K 83201 | 801 538 | K 83406 | 972 721 | K 83755 | 981 683 |
| K 83202 | 802 464 | K 83407 | 972 717 | K 83756 | 982 764 |
| K 83204 | 801 574 | K 83408 | 971 723 | K 83757 | 982 685 |
| K 83205 | 801 402 | K 83409 | 972 715 | K 83758 | 982 800 |
| K 83206 | 801 698 | K 83412 | 972 699 | K 83759 | 981 499 |
| K 83207 | 802 480 | K 83450 | 971 451 | K 83760 | 981 533 |
| K 83210 | 800 304 | K 83451 | 972 571 | K 83761 | 982 774 |
| K 83210 | 801 354 | K 83452 | 971 612 | K 83762 | 982 884 |
| K 83212 | 800 408 | K 83453 | 972 688 | K 83763 | 982 811 |
| K 83213 | 802 318 | K 83601 | 601 446 | K 83764 | 982 813 |
| K 83213 | 802 324 | K 83602 | 600 410 | K 83801 | 891 546 |
| K 83214 | 801 342 | K 83605 | 601 396 | K 83802 | 892 476 |

**VERGLEICHNUMMERNLISTE**
**CROSS REFERENCE GUIDE / LISTE DES ÉQUIVALENCES**

| <b>TIMKEN</b> | <b>OPTIMAL</b> | <b>TIMKEN</b> | <b>OPTIMAL</b> |
|---------------|----------------|---------------|----------------|
| K 83803       | 891 524        | K 84111       | 102 069        |
| K 83804       | 892 668        | K 84150       | 102 008        |
| K 83805       | 891 496        | K 84150       | 191 272        |
| K 83806       | 892 498        | K 84151       | 101 064        |
| K 83807       | 891 630        | K 84152       | 101 110        |
| K 83808       | 892 830        | K 84153       | 102 060        |
| K 83809       | 892 806        | K 84154       | 102 150        |
| K 83810       | 892 670        | K 84155       | 101 102        |
| K 83811       | 891 706        | K 84156       | 101 108        |
| K 83812       | 202 218        | K 84157       | 102 094        |
| K 83813       | 202 218        | K 84158       | 191 258        |
| K 83814       | 891 887        | K 84159       | 192 274        |
| K 84001       | 891 822        | K 84160       | 100 206        |
| K 84004       | 892 474        | K 84160       | 101 128        |
| K 84005       | 891 520        | K 84160       | 101 209        |
| K 84006       | 892 458        | K 84161       | 102 154        |
| K 84007       | 891 522        | K 84162       | 102 156        |
| K 84008       | 892 460        |               |                |
| K 84009       | 891 484        |               |                |
| K 84010       | 891 486        |               |                |
| K 84011       | 892 470        |               |                |
| K 84012       | 892 472        |               |                |
| K 84013       | 891 482        |               |                |
| K 84014       | 892 468        |               |                |
| K 84016       | 891 466        |               |                |
| K 84017       | 891 544        |               |                |
| K 84018       | 891 628        |               |                |
| K 84019       | 891 333        |               |                |
| K 84020       | 891 731        |               |                |
| K 84021       | 892 843        |               |                |
| K 84022       | 892 733        |               |                |
| K 84023       | 892 735        |               |                |
| K 84024       | 891 477        |               |                |
| K 84025       | 891 469        |               |                |
| K 84026       | 891 878        |               |                |
| K 84027       | 892 872        |               |                |
| K 84028       | 891 869        |               |                |
| K 84029       | 892 929        |               |                |
| K 84101       | 101 010        |               |                |
| K 84102       | 100 002        |               |                |
| K 84103       | 101 044        |               |                |
| K 84105       | 101 016        |               |                |
| K 84106       | 100 022        |               |                |
| K 84107       | 101 024        |               |                |
| K 84108       | 102 011        |               |                |
| K 84109       | 102 079        |               |                |
| K 84110       | 101 029        |               |                |

## VERGLEICHNUMMERNLISTE

### CROSS REFERENCE GUIDE / LISTE DES ÉQUIVALENCES

| OPTIMAL | HK    | OPTIMAL | HK    | OPTIMAL | HK    |
|---------|-------|---------|-------|---------|-------|
| 100 002 | 10/23 | 102 054 | 11/56 | 202 023 | 44/23 |
| 100 007 | 10/48 | 102 055 | 10/37 | 202 026 | 44/17 |
| 100 013 | 10/65 | 102 060 | 11/57 | 202 059 | 44/02 |
| 100 013 | 10/76 | 102 069 | 10/20 | 202 065 | 44/51 |
| 100 014 | 10/16 | 102 071 | 10/70 | 202 101 | 44/14 |
| 100 014 | 10/27 | 102 075 | 10/21 | 202 140 | 44/55 |
| 100 022 | 10/10 | 102 075 | 10/32 | 202 142 | 44/56 |
| 100 036 | 10/15 | 102 077 | 10/49 | 202 168 | 44/65 |
| 100 053 | 10/38 | 102 079 | 10/66 | 202 202 | 44/62 |
| 100 053 | 10/39 | 102 094 | 11/55 | 202 204 | 44/63 |
| 100 053 | 10/43 | 102 097 | 10/71 | 202 218 | 44/57 |
| 100 056 | 10/26 | 102 103 | 12/21 | 202 224 | 44/11 |
| 100 090 | 10/17 | 102 115 | 10/22 | 202 226 | 44/64 |
| 100 091 | 10/08 | 102 150 | 11/58 | 202 236 | 44/20 |
| 100 093 | 10/29 | 102 152 | 11/47 | 202 252 | 16/91 |
| 100 098 | 10/03 | 102 154 | 11/59 | 202 519 | 44/26 |
| 100 098 | 10/09 | 102 156 | 11/50 | 202 625 | 44/34 |
| 100 098 | 10/41 | 102 207 | 10/33 | 202 627 | 44/33 |
| 100 098 | 10/42 | 102 213 | 10/69 | 300 004 | 78/15 |
| 100 099 | 10/05 | 102 266 | 11/53 | 300 052 | 78/25 |
| 100 206 | 10/40 | 102 268 | 12/23 | 300 062 | 78/30 |
| 101 010 | 10/14 | 131 129 | 10/45 | 301 006 | 78/09 |
| 101 016 | 10/18 | 132 131 | 10/46 | 301 018 | 78/19 |
| 101 016 | 10/31 | 190 256 | 18/14 | 301 034 | 78/08 |
| 101 017 | 10/61 | 191 258 | 18/03 | 301 038 | 78/08 |
| 101 024 | 10/04 | 191 272 | 18/30 | 301 039 | 78/11 |
| 101 025 | 10/57 | 192 274 | 18/40 | 301 045 | 78/10 |
| 101 029 | 10/01 | 200 012 | 44/51 | 301 118 | 78/50 |
| 101 044 | 10/13 | 200 020 | 44/52 | 301 130 | 78/06 |
| 101 064 | 11/48 | 201 031 | 44/03 | 301 132 | 78/04 |
| 101 102 | 11/43 | 201 032 | 44/17 | 301 139 | 78/47 |
| 101 105 | 10/19 | 201 033 | 44/04 | 301 141 | 78/47 |
| 101 108 | 11/41 | 201 035 | 44/07 | 301 151 | 78/12 |
| 101 110 | 11/49 | 201 040 | 44/16 | 301 180 | 78/02 |
| 101 111 | 10/07 | 201 043 | 44/06 | 301 182 | 78/05 |
| 101 113 | 10/02 | 201 084 | 44/54 | 301 183 | 78/41 |
| 101 128 | 10/30 | 201 085 | 44/13 | 301 185 | 78/65 |
| 101 145 | 11/40 | 201 087 | 44/10 | 301 198 | 78/48 |
| 101 147 | 10/12 | 201 089 | 44/12 | 301 200 | 78/48 |
| 101 209 | 10/34 | 201 095 | 44/08 | 301 230 | 78/17 |
| 101 250 | 12/11 | 201 210 | 44/15 | 301 232 | 78/18 |
| 101 264 | 12/12 | 201 228 | 44/19 | 301 244 | 78/07 |
| 101 270 | 12/13 | 201 262 | 44/01 | 301 246 | 78/07 |
| 102 008 | 10/24 | 201 517 | 44/09 | 301 280 | 78/14 |
| 102 011 | 10/25 | 201 621 | 44/31 | 301 511 | 78/44 |
| 102 019 | 10/62 | 201 623 | 44/32 | 301 667 | 78/79 |
| 102 041 | 10/36 | 202 021 | 44/22 | 302 046 | 78/27 |

## VERGLEICHNUMMERNLISTE

### CROSS REFERENCE GUIDE / LISTE DES ÉQUIVALENCES

| OPTIMAL | HK    | OPTIMAL | HK    | OPTIMAL | HK    |
|---------|-------|---------|-------|---------|-------|
| 302 057 | 78/03 | 401 222 | 67/40 | 502 163 | 49/37 |
| 302 058 | 78/32 | 401 276 | 67/49 | 502 178 | 49/21 |
| 302 067 | 78/01 | 401 277 | 67/44 | 502 252 | 40/01 |
| 302 074 | 78/28 | 401 300 | 67/33 | 600 308 | 40/18 |
| 302 076 | 78/28 | 401 501 | 67/80 | 600 334 | 40/19 |
| 302 120 | 78/29 | 402 030 | 67/52 | 600 410 | 80/11 |
| 302 122 | 78/29 | 402 050 | 67/56 | 601 253 | 40/31 |
| 302 124 | 78/42 | 402 063 | 67/32 | 601 306 | 50/16 |
| 302 146 | 78/22 | 402 080 | 67/55 | 601 323 | 30/06 |
| 302 160 | 78/38 | 402 080 | 67/58 | 601 336 | 40/17 |
| 302 162 | 78/37 | 402 081 | 67/75 | 601 348 | 40/08 |
| 302 164 | 78/60 | 402 116 | 67/53 | 601 384 | 50/14 |
| 302 166 | 78/61 | 402 116 | 67/72 | 601 396 | 50/15 |
| 302 172 | 78/38 | 402 117 | 67/03 | 601 434 | 40/16 |
| 302 174 | 78/40 | 402 119 | 67/04 | 601 440 | 40/10 |
| 302 176 | 78/40 | 402 143 | 67/02 | 601 446 | 80/16 |
| 302 186 | 78/34 | 402 159 | 67/83 | 601 495 | 50/11 |
| 302 188 | 78/35 | 402 216 | 67/57 | 601 580 | 50/30 |
| 302 190 | 78/46 | 402 242 | 67/59 | 601 654 | 30/14 |
| 302 192 | 78/36 | 402 242 | 67/71 | 601 916 | 50/06 |
| 302 196 | 78/45 | 402 301 | 67/34 | 601 953 | 30/76 |
| 302 197 | 78/43 | 501 088 | 67/14 | 602 249 | 50/04 |
| 302 234 | 78/24 | 501 092 | 67/11 | 602 314 | 40/25 |
| 302 248 | 78/33 | 501 112 | 67/14 | 602 320 | 50/07 |
| 302 254 | 78/21 | 501 114 | 67/16 | 602 320 | 50/29 |
| 302 255 | 78/67 | 501 121 | 67/22 | 602 322 | 40/28 |
| 302 257 | 78/66 | 501 121 | 67/24 | 602 337 | 30/53 |
| 302 260 | 78/31 | 501 133 | 67/19 | 602 338 | 50/19 |
| 400 051 | 67/74 | 501 136 | 67/06 | 602 339 | 30/19 |
| 400 061 | 67/54 | 501 136 | 67/18 | 602 340 | 40/26 |
| 400 107 | 67/05 | 501 161 | 49/35 | 602 341 | 30/11 |
| 401 028 | 67/43 | 501 170 | 67/17 | 602 343 | 50/25 |
| 401 042 | 67/37 | 501 184 | 67/10 | 602 344 | 50/51 |
| 401 047 | 67/31 | 501 194 | 49/12 | 602 345 | 30/07 |
| 401 048 | 67/45 | 502 066 | 49/25 | 602 347 | 30/09 |
| 401 078 | 67/36 | 502 066 | 49/29 | 602 349 | 30/08 |
| 401 078 | 67/47 | 502 068 | 49/24 | 602 356 | 40/30 |
| 401 082 | 67/35 | 502 070 | 49/26 | 602 358 | 40/23 |
| 401 083 | 67/76 | 502 072 | 49/27 | 602 361 | 30/54 |
| 401 096 | 67/48 | 502 109 | 67/23 | 602 367 | 50/02 |
| 401 100 | 67/38 | 502 123 | 49/34 | 602 369 | 50/01 |
| 401 104 | 67/39 | 502 125 | 49/33 | 602 388 | 50/25 |
| 401 126 | 67/42 | 502 134 | 49/20 | 602 390 | 50/26 |
| 401 137 | 67/60 | 502 135 | 49/28 | 602 392 | 40/27 |
| 401 157 | 67/82 | 502 135 | 49/31 | 602 406 | 50/24 |
| 401 212 | 67/01 | 502 138 | 49/32 | 602 412 | 50/22 |
| 401 214 | 67/30 | 502 148 | 49/30 | 602 414 | 50/27 |

## VERGLEICHNUMMERNLISTE

### CROSS REFERENCE GUIDE / LISTE DES ÉQUIVALENCES

| OPTIMAL | HK    | OPTIMAL | HK    | OPTIMAL | HK    |
|---------|-------|---------|-------|---------|-------|
| 602 418 | 40/10 | 701 424 | 30/37 | 702 958 | 30/87 |
| 602 430 | 50/28 | 701 432 | 30/16 | 702 959 | 30/89 |
| 602 430 | 50/49 | 701 726 | 30/33 | 702 960 | 30/86 |
| 602 539 | 50/49 | 701 728 | 30/36 | 800 304 | 90/17 |
| 602 541 | 50/21 | 701 826 | 30/12 | 800 366 | 90/05 |
| 602 584 | 50/40 | 701 860 | 30/80 | 800 398 | 90/04 |
| 602 815 | 40/24 | 701 975 | 30/90 | 800 398 | 90/51 |
| 602 821 | 50/20 | 701 977 | 30/84 | 800 400 | 90/07 |
| 602 859 | 50/21 | 701 978 | 30/85 | 800 408 | 90/16 |
| 602 865 | 40/11 | 702 309 | 30/38 | 801 238 | 06/11 |
| 602 926 | 50/09 | 702 311 | 30/42 | 801 267 | 90/81 |
| 602 937 | 50/50 | 702 312 | 30/30 | 801 342 | 90/01 |
| 602 956 | 30/82 | 702 312 | 30/68 | 801 354 | 96/10 |
| 681 259 | 40/04 | 702 316 | 30/26 | 801 360 | 90/06 |
| 681 261 | 40/02 | 702 321 | 30/65 | 801 362 | 90/50 |
| 681 303 | 30/58 | 702 328 | 30/22 | 801 364 | 90/52 |
| 681 325 | 50/33 | 702 350 | 30/21 | 801 372 | 95/10 |
| 681 471 | 40/40 | 702 351 | 30/62 | 801 376 | 90/50 |
| 681 504 | 90/33 | 702 352 | 30/25 | 801 382 | 90/16 |
| 681 506 | 50/31 | 702 353 | 30/67 | 801 402 | 90/13 |
| 681 640 | 90/32 | 702 355 | 30/63 | 801 428 | 06/16 |
| 681 909 | 90/44 | 702 357 | 30/64 | 801 438 | 06/14 |
| 681 910 | 90/44 | 702 359 | 30/61 | 801 442 | 91/01 |
| 681 923 | 90/83 | 702 365 | 30/50 | 801 450 | 90/08 |
| 682 263 | 40/01 | 702 380 | 30/24 | 801 478 | 06/15 |
| 682 305 | 30/57 | 702 380 | 30/38 | 801 500 | 90/54 |
| 682 327 | 50/42 | 702 426 | 30/27 | 801 538 | 90/11 |
| 682 329 | 50/43 | 702 436 | 30/43 | 801 543 | 14/03 |
| 682 420 | 90/43 | 702 448 | 30/46 | 801 554 | 06/05 |
| 682 422 | 90/43 | 702 452 | 30/39 | 801 574 | 90/12 |
| 682 490 | 90/49 | 702 456 | 30/44 | 801 588 | 06/10 |
| 682 492 | 90/49 | 702 462 | 30/47 | 801 618 | 14/01 |
| 682 508 | 50/41 | 702 494 | 30/31 | 801 644 | 90/38 |
| 682 510 | 50/41 | 702 494 | 30/51 | 801 656 | 90/09 |
| 682 642 | 90/42 | 702 514 | 30/35 | 801 694 | 14/02 |
| 700 245 | 30/92 | 702 537 | 30/49 | 801 698 | 90/15 |
| 700 310 | 30/02 | 702 550 | 30/29 | 801 730 | 90/61 |
| 700 310 | 30/03 | 702 550 | 30/40 | 801 750 | 90/38 |
| 701 247 | 44/29 | 702 552 | 30/41 | 801 836 | 90/50 |
| 701 302 | 30/18 | 702 586 | 30/55 | 801 838 | 90/30 |
| 701 307 | 30/05 | 702 692 | 30/48 | 801 838 | 90/35 |
| 701 319 | 30/66 | 702 817 | 30/21 | 801 880 | 90/67 |
| 701 326 | 30/17 | 702 846 | 30/78 | 801 922 | 90/10 |
| 701 332 | 30/15 | 702 846 | 30/81 | 801 950 | 90/68 |
| 701 346 | 30/02 | 702 850 | 30/69 | 801 961 | 06/30 |
| 701 374 | 30/13 | 702 866 | 30/73 | 801 970 | 90/76 |
| 701 404 | 30/34 | 702 957 | 30/88 | 801 972 | 90/70 |

## VERGLEICHSDATUMMERNLISTE

### CROSS REFERENCE GUIDE / LISTE DES ÉQUIVALENCES

| OPTIMAL | HK    | OPTIMAL | HK    | OPTIMAL | HK    |
|---------|-------|---------|-------|---------|-------|
| 801 974 | 90/80 | 881 594 | 20/18 | 892 806 | 65/23 |
| 802 271 | 90/72 | 881 622 | 20/15 | 892 830 | 65/22 |
| 802 315 | 90/55 | 881 704 | 17/09 | 892 843 | 60/12 |
| 802 318 | 90/24 | 882 167 | 17/42 | 892 872 | 60/28 |
| 802 324 | 90/24 | 882 235 | 20/32 | 901 425 | 16/11 |
| 802 330 | 90/23 | 882 598 | 20/20 | 901 427 | 16/02 |
| 802 331 | 90/64 | 882 624 | 20/28 | 901 427 | 16/03 |
| 802 335 | 06/03 | 882 664 | 20/23 | 901 429 | 16/07 |
| 802 368 | 90/29 | 882 727 | 20/30 | 901 445 | 16/05 |
| 802 370 | 90/34 | 882 729 | 20/29 | 901 461 | 16/01 |
| 802 378 | 90/60 | 882 875 | 20/25 | 902 443 | 16/06 |
| 802 394 | 90/26 | 891 333 | 60/09 | 902 457 | 16/21 |
| 802 444 | 90/36 | 891 466 | 60/02 | 902 459 | 16/22 |
| 802 454 | 90/19 | 891 469 | 60/04 | 902 771 | 16/09 |
| 802 464 | 90/21 | 891 477 | 60/13 | 902 855 | 16/10 |
| 802 480 | 90/20 | 891 482 | 60/18 | 911 375 | 17/18 |
| 802 485 | 06/06 | 891 484 | 60/19 | 911 377 | 17/03 |
| 802 488 | 06/25 | 891 486 | 60/05 | 911 377 | 17/04 |
| 802 526 | 90/53 | 891 496 | 65/16 | 911 385 | 17/07 |
| 802 528 | 06/01 | 891 509 | 65/12 | 911 387 | 17/06 |
| 802 540 | 06/26 | 891 520 | 60/17 | 911 399 | 17/19 |
| 802 542 | 06/26 | 891 522 | 60/16 | 911 513 | 17/13 |
| 802 556 | 06/22 | 891 524 | 65/14 | 911 600 | 17/16 |
| 802 558 | 06/22 | 891 536 | 60/01 | 911 621 | 17/14 |
| 802 560 | 06/27 | 891 544 | 60/03 | 911 623 | 17/15 |
| 802 562 | 06/28 | 891 546 | 65/15 | 911 625 | 17/14 |
| 802 590 | 90/18 | 891 628 | 60/04 | 911 629 | 17/01 |
| 802 620 | 95/10 | 891 630 | 65/02 | 911 777 | 17/12 |
| 802 646 | 06/24 | 891 706 | 65/14 | 911 782 | 17/17 |
| 802 652 | 06/20 | 891 731 | 60/10 | 912 401 | 17/28 |
| 802 658 | 91/10 | 891 822 | 60/11 | 912 403 | 17/29 |
| 802 720 | 14/20 | 891 869 | 60/31 | 912 423 | 17/11 |
| 802 732 | 14/21 | 891 878 | 60/21 | 912 471 | 17/25 |
| 802 748 | 90/47 | 892 458 | 60/26 | 912 473 | 17/23 |
| 802 839 | 90/31 | 892 460 | 60/23 | 912 505 | 17/21 |
| 802 839 | 90/71 | 892 468 | 60/29 | 912 515 | 17/22 |
| 802 870 | 06/04 | 892 470 | 60/27 | 912 518 | 17/31 |
| 802 954 | 90/03 | 892 472 | 60/27 | 912 530 | 17/26 |
| 802 980 | 90/73 | 892 474 | 60/25 | 912 532 | 17/27 |
| 880 419 | 20/01 | 892 476 | 65/25 | 912 545 | 17/30 |
| 880 421 | 20/02 | 892 498 | 65/27 | 912 775 | 17/08 |
| 880 525 | 20/21 | 892 668 | 65/26 | 912 803 | 17/32 |
| 880 812 | 20/14 | 892 670 | 65/24 | 920 752 | 19/10 |
| 880 912 | 20/03 | 892 733 | 60/06 | 921 555 | 26/06 |
| 881 507 | 20/12 | 892 735 | 60/08 | 922 439 | 19/02 |
| 881 534 | 20/16 | 892 802 | 60/24 | 922 441 | 19/01 |
| 881 592 | 20/13 | 892 804 | 60/20 | 922 557 | 26/07 |

## VERGLEICHNUMMERNLISTE

### CROSS REFERENCE GUIDE / LISTE DES ÉQUIVALENCES

| OPTIMAL | HK    | OPTIMAL | HK    | OPTIMAL | HK    |
|---------|-------|---------|-------|---------|-------|
| 922 781 | 19/05 | 951 409 | 19/09 | 962 517 | 13/24 |
| 922 783 | 19/06 | 951 449 | 19/15 | 962 548 | 13/64 |
| 922 787 | 26/04 | 951 519 | 19/11 | 962 601 | 13/06 |
| 922 789 | 26/05 | 951 604 | 19/17 | 962 682 | 13/28 |
| 922 797 | 19/03 | 951 606 | 19/13 | 962 684 | 13/22 |
| 922 799 | 19/04 | 951 708 | 19/30 | 962 684 | 13/42 |
| 922 854 | 19/07 | 951 722 | 19/14 | 962 686 | 13/40 |
| 922 882 | 19/01 | 951 756 | 19/12 | 962 703 | 13/05 |
| 940 371 | 15/09 | 952 405 | 19/08 | 962 705 | 13/44 |
| 940 632 | 15/06 | 952 415 | 19/41 | 962 712 | 13/34 |
| 941 497 | 15/10 | 952 417 | 19/42 | 962 714 | 13/37 |
| 941 565 | 15/31 | 952 551 | 19/16 | 962 716 | 13/31 |
| 941 602 | 15/07 | 952 593 | 19/21 | 962 718 | 13/21 |
| 941 617 | 15/16 | 952 608 | 19/28 | 962 755 | 13/51 |
| 941 634 | 15/13 | 952 661 | 19/24 | 962 757 | 13/65 |
| 941 636 | 15/15 | 952 676 | 19/26 | 962 760 | 13/27 |
| 941 647 | 15/17 | 952 678 | 19/25 | 962 767 | 13/56 |
| 941 700 | 15/03 | 952 679 | 19/22 | 962 776 | 13/23 |
| 941 734 | 15/14 | 952 710 | 19/23 | 962 779 | 13/47 |
| 941 786 | 15/12 | 952 758 | 19/40 | 962 810 | 13/33 |
| 941 840 | 15/03 | 952 769 | 19/29 | 962 841 | 13/60 |
| 941 842 | 15/29 | 952 832 | 19/20 | 962 853 | 13/46 |
| 941 842 | 15/58 | 960 578 | 13/09 | 962 899 | 13/07 |
| 941 862 | 15/55 | 960 638 | 13/02 | 962 905 | 13/59 |
| 941 873 | 15/08 | 960 702 | 13/32 | 962 913 | 13/58 |
| 941 874 | 15/13 | 961 411 | 13/08 | 962 949 | 13/68 |
| 942 381 | 15/54 | 961 479 | 13/63 | 971 391 | 44/16 |
| 942 501 | 15/25 | 961 503 | 13/13 | 971 393 | 44/17 |
| 942 566 | 15/21 | 961 576 | 13/17 | 971 451 | 23/02 |
| 942 568 | 15/24 | 961 610 | 13/03 | 971 455 | 23/05 |
| 942 569 | 15/51 | 961 648 | 13/04 | 971 567 | 23/04 |
| 942 569 | 15/56 | 961 677 | 13/35 | 971 575 | 23/06 |
| 942 570 | 15/24 | 961 680 | 13/14 | 971 612 | 23/03 |
| 942 619 | 15/27 | 961 701 | 13/43 | 971 615 | 22/01 |
| 942 672 | 15/26 | 961 724 | 13/36 | 971 627 | 22/02 |
| 942 674 | 15/22 | 961 751 | 13/48 | 971 631 | 22/03 |
| 942 695 | 15/40 | 961 753 | 13/49 | 971 635 | 22/02 |
| 942 738 | 15/19 | 961 759 | 13/52 | 971 641 | 22/05 |
| 942 754 | 15/40 | 961 765 | 13/55 | 971 707 | 22/14 |
| 942 768 | 15/23 | 961 792 | 13/18 | 971 791 | 25/07 |
| 942 770 | 15/23 | 961 796 | 13/10 | 971 795 | 25/09 |
| 942 773 | 15/53 | 961 808 | 13/30 | 972 389 | 44/51 |
| 942 788 | 19/20 | 961 883 | 13/15 | 972 397 | 44/56 |
| 942 818 | 15/28 | 961 904 | 13/16 | 972 453 | 23/12 |
| 942 820 | 15/28 | 962 413 | 13/62 | 972 453 | 23/30 |
| 942 844 | 15/56 | 962 435 | 13/41 | 972 465 | 22/10 |
| 942 845 | 15/57 | 962 481 | 13/45 | 972 571 | 23/09 |



**VERGLEICHNUMMERNLISTE**
**CROSS REFERENCE GUIDE / LISTE DES ÉQUIVALENCES**

| OPTIMAL | HK    | OPTIMAL        | HK          | OPTIMAL | KACO   |
|---------|-------|----------------|-------------|---------|--------|
| 972 573 | 23/10 | 982 813        | 18/46       | 102 041 | 0038.2 |
| 972 633 | 22/12 | 982 816        | 18/22       | 102 054 | 5032.2 |
| 972 637 | 22/13 | 982 857        | 18/57       | 102 060 | 5033.2 |
| 972 639 | 22/11 | 982 884        | 18/44       | 102 094 | 5028.2 |
| 972 688 | 23/15 | 991 898        | 70/02       | 102 150 | 5016.2 |
| 972 699 | 23/40 | 991 998        | 70/01       | 102 152 | 5050.2 |
| 972 709 | 22/15 | 992 943        | 70/20       | 102 154 | 5051.2 |
| 972 719 | 23/13 |                |             | 102 156 | 5053.2 |
| 972 793 | 25/08 | <b>OPTIMAL</b> | <b>KACO</b> | 102 266 | 5023.2 |
| 980 614 | 18/51 | 100 002        | 0015.2      | 102 268 | 4510.2 |
| 981 407 | 18/31 | 100 002        | 0016.2      | 131 129 | 5055.1 |
| 981 447 | 18/11 | 100 002        | 5015.2      | 132 131 | 5056.2 |
| 981 475 | 18/18 | 100 002        | 5022.1      | 190 256 | 4415.1 |
| 981 499 | 18/39 | 100 014        | 5030.1      | 191 272 | 5042.1 |
| 981 533 | 18/41 | 100 022        | 5011.1      | 192 274 | 5044.2 |
| 981 535 | 06/12 | 100 022        | 5033.2      | 200 012 | 4025.1 |
| 981 572 | 18/02 | 100 022        | 5052.0      | 200 020 | 4021.1 |
| 981 616 | 18/15 | 100 036        | 0018.1      | 201 032 | 4028.1 |
| 981 690 | 18/08 | 100 036        | 0021.1      | 201 040 | 4031.1 |
| 981 742 | 18/13 | 100 053        | 0039.1      | 201 084 | 4011.1 |
| 981 743 | 18/35 | 100 056        | 0019.1      | 201 084 | 4012.1 |
| 981 744 | 18/16 | 100 056        | 0022.1      | 201 210 | 4019.1 |
| 981 745 | 18/36 | 100 090        | 0020.1      | 201 228 | 4023.1 |
| 981 747 | 18/37 | 100 090        | 0030.1      | 202 026 | 4018.2 |
| 981 763 | 18/43 | 100 090        | 0036.1      | 202 140 | 4015.2 |
| 981 790 | 18/10 | 100 098        | 0029.1      | 202 142 | 4017.2 |
| 981 814 | 18/11 | 100 098        | 0034.1      | 202 168 | 4016.2 |
| 981 851 | 18/04 | 100 098        | 0037.1      | 202 202 | 4026.2 |
| 981 856 | 18/55 | 100 099        | 0013.1      | 202 204 | 4027.2 |
| 981 868 | 18/56 | 100 206        | 5047.2      | 202 218 | 4024.2 |
| 982 373 | 18/29 | 101 010        | 5029.1      | 202 226 | 4033.2 |
| 982 379 | 18/34 | 101 016        | 5034.1      | 202 236 | 4029.2 |
| 982 431 | 18/19 | 101 016        | 5054.1      | 202 252 | 4014.2 |
| 982 431 | 18/26 | 101 024        | 5049.1      | 300 004 | 3021.2 |
| 982 561 | 18/06 | 101 044        | 0016.1      | 300 052 | 3015.1 |
| 982 581 | 18/28 | 101 064        | 5031.1      | 300 062 | 3017.1 |
| 982 650 | 18/20 | 101 102        | 5038.1      | 301 006 | 3030.1 |
| 982 685 | 18/21 | 101 108        | 5041.1      | 301 018 | 3031.1 |
| 982 737 | 18/32 | 101 110        | 5039.1      | 301 034 | 3032.1 |
| 982 749 | 18/38 | 101 128        | 5046.1      | 301 038 | 3033.1 |
| 982 762 | 18/42 | 101 145        | 5019.1      | 301 118 | 3025.1 |
| 982 764 | 18/21 | 101 147        | 5030.1      | 301 130 | 3046.1 |
| 982 766 | 18/27 | 101 250        | 4512.1      | 301 132 | 3003.1 |
| 982 774 | 18/44 | 101 264        | 4511.1      | 301 151 | 3016.1 |
| 982 778 | 18/23 | 101 270        | 4509.1      | 301 180 | 3009.1 |
| 982 780 | 18/25 | 102 008        | 0012.2      | 301 182 | 2999.1 |
| 982 811 | 18/45 | 102 008        | 0023.2      | 301 198 | 2993.1 |
|         |       | 102 008        | 5024.2      |         |        |

## VERGLEICHNUMMERNLISTE

### CROSS REFERENCE GUIDE / LISTE DES ÉQUIVALENCES

| OPTIMAL | KACO   | OPTIMAL | KACO   | OPTIMAL | KACO   |
|---------|--------|---------|--------|---------|--------|
| 301 200 | 2992.1 | 401 214 | 2031.1 | 601 440 | 1050.1 |
| 301 230 | 3027.1 | 401 222 | 2012.0 | 601 446 | 3217.1 |
| 301 232 | 3040.1 | 401 222 | 2012.1 | 601 446 | 4217.1 |
| 301 244 | 3042.1 | 401 276 | 2010.0 | 601 495 | 4316.1 |
| 301 246 | 3043.1 | 401 276 | 2010.1 | 601 502 | 1068.1 |
| 301 280 | 3019.1 | 402 030 | 2013.0 | 601 521 | 3300.1 |
| 302 046 | 3049.2 | 402 030 | 2013.2 | 601 654 | 4301.1 |
| 302 058 | 3002.2 | 402 050 | 2030.0 | 601 828 | 1052   |
| 302 058 | 3008.2 | 402 050 | 2030.2 | 602 314 | 1075.2 |
| 302 074 | 3034.2 | 402 080 | 2026.2 | 602 314 | 4327.2 |
| 302 076 | 3048.2 | 402 080 | 2027.2 | 602 320 | 4318.2 |
| 302 120 | 3044.2 | 402 116 | 2029.2 | 602 322 | 1056.2 |
| 302 122 | 3045.2 | 402 116 | 2036.2 | 602 338 | 4322.2 |
| 302 146 | 3024.2 | 402 116 | 2058.0 | 602 340 | 1057.2 |
| 302 160 | 3011.2 | 402 116 | 2058.2 | 602 340 | 1064.2 |
| 302 162 | 3007.2 | 402 143 | 2034.2 | 602 340 | 4307.2 |
| 302 164 | 3018.2 | 402 216 | 2032.2 | 602 344 | 4325.2 |
| 302 166 | 3012.2 | 402 242 | 2038.2 | 602 356 | 1074.2 |
| 302 172 | 3022.2 | 402 242 | 2039.2 | 602 358 | 1061.2 |
| 302 174 | 3006.2 | 501 088 | 1025.1 | 602 388 | 4319.2 |
| 302 176 | 3005.2 | 501 092 | 1010.1 | 602 390 | 4320.2 |
| 302 186 | 2998.2 | 501 112 | 1031.1 | 602 392 | 1067.2 |
| 302 188 | 2997.1 | 501 114 | 1023.1 | 602 406 | 4313.2 |
| 302 190 | 2994.2 | 501 114 | 1027.1 | 602 412 | 4311.2 |
| 302 192 | 2996.2 | 501 136 | 1035.1 | 602 414 | 4223.2 |
| 302 196 | 2995.2 | 501 170 | 1033.1 | 602 414 | 4321.2 |
| 302 208 | 3029.2 | 501 184 | 1020.1 | 602 416 | 1053.2 |
| 302 234 | 3026.2 | 501 194 | 1017.1 | 602 418 | 1051.2 |
| 302 240 | 3004.2 | 502 066 | 1028.2 | 602 430 | 4306.2 |
| 302 248 | 3001.2 | 502 068 | 1026.2 | 602 512 | 1071.2 |
| 302 254 | 3023.2 | 502 070 | 1024.2 | 602 539 | 4309.2 |
| 302 260 | 3000.2 | 502 072 | 1034.2 | 602 541 | 4304.2 |
| 401 028 | 2020.0 | 502 134 | 1018.2 | 602 815 | 1059.2 |
| 401 028 | 2020.1 | 502 138 | 1036.2 | 602 815 | 4302.2 |
| 401 042 | 2028.0 | 502 148 | 1037.2 | 602 821 | 4312.2 |
| 401 042 | 2028.1 | 502 158 | 1021.2 | 602 833 | 3020.2 |
| 401 048 | 2057.0 | 502 178 | 1009.2 | 602 859 | 4317.2 |
| 401 048 | 2057.1 | 600 308 | 1069.1 | 602 865 | 1072.2 |
| 401 078 | 2035.1 | 600 334 | 1054.1 | 700 310 | 4116.1 |
| 401 082 | 2037.1 | 600 410 | 4210.1 | 701 302 | 4122.1 |
| 401 096 | 2060.1 | 601 306 | 4308.1 | 701 302 | 4142.1 |
| 401 100 | 2024.1 | 601 336 | 1063.1 | 701 307 | 4145.1 |
| 401 104 | 2025.1 | 601 336 | 4305.1 | 701 307 | 4151.1 |
| 401 126 | 2021.0 | 601 348 | 4323.1 | 701 326 | 4127.1 |
| 401 126 | 2021.1 | 601 384 | 4314.1 | 701 332 | 4125.1 |
| 401 137 | 2033.1 | 601 396 | 4315.1 | 701 374 | 4110.1 |
| 401 212 | 2040.1 | 601 434 | 1060.1 | 701 404 | 4124.1 |

## VERGLEICHSDATUMMERNLISTE

### CROSS REFERENCE GUIDE / LISTE DES ÉQUIVALENCES

| OPTIMAL | KACO   | OPTIMAL | KACO   | OPTIMAL | KACO   |
|---------|--------|---------|--------|---------|--------|
| 701 432 | 4129.1 | 801 500 | 0115.1 | 881 594 | 7002.1 |
| 701 432 | 4315.1 | 801 500 | 0120.1 | 881 622 | 3405.1 |
| 701 826 | 4111.1 | 801 538 | 2112.1 | 881 704 | 3123.1 |
| 702 309 | 4146.2 | 801 554 | 0119.1 | 882 598 | 3402.2 |
| 702 311 | 4147.2 | 801 574 | 2110.1 | 882 643 | 7003.2 |
| 702 311 | 4148.2 | 801 588 | 0104.1 | 882 664 | 3406.2 |
| 702 312 | 4123.1 | 801 618 | 4700.1 | 882 666 | 3701.2 |
| 702 312 | 4123.2 | 801 656 | 5100.1 | 882 819 | 3403.2 |
| 702 312 | 4137.1 | 801 698 | 2120.1 | 882 863 | 3403.2 |
| 702 312 | 4139.1 | 801 730 | 2150.1 | 891 466 | 6013.1 |
| 702 316 | 4119.2 | 801 922 | 2116.1 | 891 466 | 6014.1 |
| 702 328 | 4112.1 | 802 318 | 2126.2 | 891 482 | 6012.1 |
| 702 328 | 4118.2 | 802 324 | 2138.2 | 891 484 | 6011.1 |
| 702 350 | 4130.2 | 802 330 | 2118.2 | 891 486 | 6016.1 |
| 702 352 | 4120.2 | 802 330 | 2122.2 | 891 496 | 4613.1 |
| 702 426 | 4135.2 | 802 368 | 2135.2 | 891 509 | 4602.1 |
| 702 452 | 4126.2 | 802 368 | 3503.2 | 891 520 | 6002.1 |
| 702 452 | 4128.2 | 802 370 | 2136.2 | 891 522 | 6003.1 |
| 702 494 | 4133.2 | 802 370 | 3504.2 | 891 524 | 4603.1 |
| 702 494 | 4134.2 | 802 378 | 2115.2 | 891 546 | 4605.1 |
| 702 514 | 4132.2 | 802 394 | 2124.2 | 891 706 | 4604.1 |
| 702 550 | 4131.2 | 802 444 | 2141.2 | 891 822 | 1100.1 |
| 702 552 | 4136.2 | 802 454 | 5101.2 | 892 458 | 6006.2 |
| 702 817 | 4113.2 | 802 464 | 2117.2 | 892 460 | 6004.2 |
| 800 304 | 2131.1 | 802 480 | 2121.2 | 892 468 | 6001.2 |
| 800 366 | 2140.1 | 802 488 | 0111.2 | 892 470 | 6010.2 |
| 800 398 | 2144.1 | 802 526 | 2146.1 | 892 472 | 6015.2 |
| 800 398 | 2149.1 | 802 528 | 0121.2 | 892 474 | 6005.2 |
| 800 400 | 2132.1 | 802 540 | 0114.2 | 892 476 | 4611.2 |
| 800 400 | 3502.1 | 802 542 | 0109.2 | 892 498 | 4614.2 |
| 800 408 | 2114.1 | 802 556 | 0110.2 | 892 668 | 4612.2 |
| 801 238 | 0100.1 | 802 558 | 0107.2 | 892 670 | 4610.2 |
| 801 342 | 2108.1 | 802 560 | 0116.2 | 892 802 | 6009.2 |
| 801 342 | 2123.1 | 802 562 | 0117.2 | 892 804 | 1103.2 |
| 801 354 | 5200.1 | 802 590 | 5102.2 | 892 806 | 4609.2 |
| 801 360 | 2125.1 | 802 620 | 3500.1 | 892 830 | 4608.2 |
| 801 362 | 2148.1 | 802 646 | 0101.2 | 901 461 | 1500.1 |
| 801 364 | 2147.1 | 802 652 | 0105.2 | 901 461 | 1501.1 |
| 801 372 | 3501.1 | 802 658 | 5104.2 | 902 457 | 1503.2 |
| 801 376 | 2145.1 | 802 720 | 4701.2 | 902 459 | 1502.2 |
| 801 382 | 2142.1 | 802 732 | 4703.2 | 911 375 | 3118.1 |
| 801 402 | 2111.1 | 880 525 | 3401.1 | 911 375 | 3121.1 |
| 801 428 | 0118.1 | 880 812 | 7000.1 | 911 375 | 3122.1 |
| 801 438 | 0108.1 | 881 507 | 3400.1 | 911 385 | 3138.2 |
| 801 442 | 5103.1 | 881 534 | 3407.1 | 911 387 | 3139.1 |
| 801 450 | 2127.1 | 881 564 | 3700.1 | 911 513 | 3113.1 |
| 801 478 | 0106.1 | 881 592 | 7001.1 | 911 513 | 3117.1 |

## VERGLEICHNUMMERNLISTE

### CROSS REFERENCE GUIDE / LISTE DES ÉQUIVALENCES

| OPTIMAL | KACO   | OPTIMAL | KACO   | OPTIMAL        | KACO      |
|---------|--------|---------|--------|----------------|-----------|
| 911 600 | 3120.1 | 951 722 | 3200.1 | 972 637        | 8007.2    |
| 911 621 | 3119.1 | 951 756 | 3205.1 | 972 639        | 8003.2    |
| 911 623 | 3129.1 | 952 593 | 3203.2 | 972 699        | 4809.2    |
| 911 777 | 3140.2 | 952 608 | 3215.1 | 981 447        | 4417.1    |
| 911 782 | 3115.1 | 952 661 | 3206.2 | 981 535        | 0102.1    |
| 912 471 | 3132.2 | 952 676 | 3212.1 | 981 535        | 4400.1    |
| 912 473 | 3128.2 | 952 679 | 3210.1 | 981 572        | 4401.1    |
| 912 505 | 3112.2 | 952 710 | 3208.2 | 981 690        | 4416.1    |
| 912 515 | 3116.2 | 952 832 | 3202.2 | 981 742        | 4407.1    |
| 912 515 | 3126.2 | 960 578 | 2067.1 | 981 744        | 4411.1    |
| 912 530 | 3125.2 | 960 578 | 2069.1 | 981 790        | 4202.1    |
| 912 530 | 3130.2 | 960 578 | 3211.1 | 981 790        | 4402.1    |
| 912 530 | 3133.1 | 960 638 | 2072.1 | 981 814        | 4405.1    |
| 912 532 | 3127.2 | 960 638 | 2081.1 | 982 373        | 4412.2    |
| 912 545 | 3141.1 | 960 702 | 2066.2 | 982 650        | 4403.2    |
| 912 775 | 3136.1 | 961 503 | 2053.1 | 982 764        | 4404.2    |
| 920 752 | 3201.1 | 961 576 | 2063.1 | 982 766        | 4410.2    |
| 940 632 | 3062.1 | 961 610 | 2068.1 | 982 778        | 4409.2    |
| 941 497 | 3052.1 | 961 648 | 2076.1 | 982 780        | 4413.2    |
| 941 602 | 3063.1 | 961 680 | 2048.1 | 982 816        | 4408.2    |
| 941 617 | 3071.1 | 961 792 | 2049.1 |                |           |
| 941 634 | 3057.1 | 961 796 | 2052.1 | <b>OPTIMAL</b> | <b>QH</b> |
| 941 636 | 3054.1 | 961 883 | 2047.1 | 100 002        | QWB 201   |
| 941 700 | 3072.1 | 962 517 | 2061.2 | 100 002        | QWB 209   |
| 941 734 | 3059.1 | 962 548 | 2070.2 | 100 002        | QWB 796   |
| 941 784 | 3077.1 | 962 682 | 2046.2 | 100 014        | QWB 510   |
| 941 786 | 3053.1 | 962 682 | 2046.2 | 100 022        | QWB 698   |
| 942 501 | 3056.2 | 962 684 | 2055.2 | 100 022        | QWB 823   |
| 942 501 | 3070.2 | 962 703 | 2073.2 | 100 036        | QWB 511   |
| 942 566 | 3060.2 | 962 705 | 2079.2 | 100 056        | QWB 720   |
| 942 568 | 3061.2 | 962 712 | 2075.2 | 100 090        | QWB 683   |
| 942 569 | 3073.2 | 962 714 | 2080.2 | 100 090        | QWB 845   |
| 942 570 | 3055.2 | 962 716 | 2065.1 | 100 090        | QWB 955   |
| 942 619 | 3069.2 | 962 718 | 2056.1 | 100 098        | QWB 733   |
| 942 672 | 3068.2 | 962 760 | 2045.2 | 100 098        | QWB 945   |
| 942 674 | 3058.2 | 962 776 | 2062.2 | 100 099        | QWB 733   |
| 942 768 | 3064.2 | 971 451 | 4801.1 | 100 206        | QWB 997   |
| 942 770 | 3065.2 | 971 455 | 4806.1 | 101 010        | QWB 328   |
| 942 773 | 3074.2 | 971 615 | 8001.1 | 101 016        | QWB 512   |
| 942 788 | 3051.2 | 971 627 | 8000.1 | 101 024        | QWB 880   |
| 942 818 | 3066.2 | 971 631 | 8004.1 | 101 044        | QWB 200   |
| 942 820 | 3067.2 | 971 635 | 8005.1 | 101 044        | QWB 827   |
| 951 519 | 3204.1 | 971 641 | 8006.1 | 101 064        | QWB 407   |
| 951 604 | 3209.1 | 972 453 | 4805.1 | 101 102        | QWB 522   |
| 951 604 | 3213.2 | 972 453 | 4810.2 | 101 105        | QWB 932   |
| 951 606 | 3207.1 | 972 465 | 8002.2 | 101 108        | QWB 521   |
| 951 606 | 3214.2 | 972 573 | 4802.2 | 101 110        | QWB 544   |
|         |        | 972 573 | 4812.1 | 101 113        | QWB 1089  |

## VERGLEICHNUMMERNLISTE

### CROSS REFERENCE GUIDE / LISTE DES ÉQUIVALENCES

| OPTIMAL | QH       | OPTIMAL | QH       | OPTIMAL | QH       |
|---------|----------|---------|----------|---------|----------|
| 101 128 | QWB 997  | 202 026 | QWB 436  | 302 122 | QWB 533  |
| 101 145 | QWB 389  | 202 059 | QWB 1115 | 302 124 | QWB 756  |
| 101 147 | QWB 510  | 202 065 | QWB 590  | 302 146 | QWB 152C |
| 101 209 | QWB 997  | 202 140 | QWB 876  | 302 160 | QWB 193C |
| 101 250 | QWB 993  | 202 142 | QWB 877  | 302 162 | QWB 180C |
| 101 264 | QWB 992  | 202 168 | QWB 570  | 302 164 | QWB 864  |
| 101 270 | QWB 991  | 202 202 | QWB 281  | 302 166 | QWB 865  |
| 102 008 | QWB 429  | 202 204 | QWB 280  | 302 172 | QWB 194C |
| 102 008 | QWB 797  | 202 218 | QWB 879  | 302 174 | QWB 632  |
| 102 011 | QWB 1137 | 202 226 | QWB 495  | 302 176 | QWB 633  |
| 102 054 | QWB 546  | 202 236 | QWB 177C | 302 186 | QWB 860  |
| 102 060 | QWB 496  | 202 252 | QWB 283  | 302 188 | QWB 862  |
| 102 069 | QWB 1160 | 202 625 | QWB 1309 | 302 190 | QWB 867  |
| 102 071 | QWB 1319 | 202 627 | QWB 1310 | 302 192 | QWB 861  |
| 102 075 | QWB 1257 | 300 004 | QWB 416  | 302 196 | QWB 866  |
| 102 079 | QWB 1283 | 300 052 | QWB 113C | 302 208 | QWB 593  |
| 102 094 | QWB 406  | 300 062 | QWB 414  | 302 234 | QWB 140C |
| 102 115 | QWB 1055 | 301 006 | QWB 418  | 302 240 | QWB 686  |
| 102 115 | QWB 1095 | 301 018 | QWB 420  | 302 248 | QWB 852  |
| 102 150 | QWB 751  | 301 034 | QWB 569  | 302 254 | QWB 151C |
| 102 152 | QWB 494  | 301 038 | QWB 568  | 302 255 | QWB 1259 |
| 102 213 | QWB 1326 | 301 039 | QWB 1126 | 302 257 | QWB 1260 |
| 102 266 | QWB 333  | 301 045 | QWB 1127 | 302 260 | QWB 840  |
| 132 131 | QWB 1000 | 301 118 | QWB 863  | 400 107 | QWB 1057 |
| 190 256 | QWB 578  | 301 130 | QWB 543  | 401 028 | QWB 255  |
| 191 272 | QWB 693  | 301 132 | QWB 817  | 401 042 | QWB 654  |
| 192 274 | QWB 356  | 301 139 | QWB 1110 | 401 047 | QWB 1068 |
| 192 274 | QWB 694  | 301 141 | QWB 1111 | 401 048 | QWB 508  |
| 200 012 | QWB 155C | 301 151 | QWB 114C | 401 078 | QWB 1070 |
| 200 020 | QWB 596  | 301 180 | QWB 696  | 401 096 | QWB 758  |
| 201 031 | QWB 1117 | 301 182 | QWB 859  | 401 100 | QWB 773  |
| 201 032 | QWB 436  | 301 198 | QWB 912  | 401 104 | QWB 769  |
| 201 032 | QWB 832  | 301 200 | QWB 913  | 401 126 | QWB 659  |
| 201 033 | QWB 1112 | 301 230 | QWB 184C | 401 137 | QWB 752  |
| 201 035 | QWB 1113 | 301 232 | QWB 158C | 401 222 | QWB 256  |
| 201 040 | QWB 417  | 301 244 | QWB 530  | 401 300 | QWB 1288 |
| 201 040 | QWB 789  | 301 246 | QWB 531  | 402 030 | QWB 259  |
| 201 043 | QWB 1114 | 301 280 | QWB 115C | 402 050 | QWB 752  |
| 201 084 | QWB 603  | 301 767 | QWB 1293 | 402 050 | QWB 813  |
| 201 084 | QWB 903  | 302 046 | QWB 567  | 402 063 | QWB 1069 |
| 201 095 | QWB 1211 | 302 057 | QWB 1128 | 402 080 | QWB 754  |
| 201 210 | QWB 935  | 302 058 | QWB 697  | 402 116 | QWB 536  |
| 201 228 | QWB 878  | 302 058 | QWB 1082 | 402 301 | QWB 1289 |
| 201 262 | QWB 948  | 302 058 | QWB 1125 | 402 827 | QWB 1339 |
| 201 262 | QWB 963  | 302 074 | QWB 527  | 501 088 | QWB 576  |
| 201 621 | QWB 1307 | 302 076 | QWB 528  | 501 092 | QWB 517  |
| 201 623 | QWB 1308 | 302 120 | QWB 532  | 501 112 | QWB 534  |

## VERGLEICHNUMMERNLISTE

### CROSS REFERENCE GUIDE / LISTE DES ÉQUIVALENCES

| OPTIMAL | QH       | OPTIMAL | QH       | OPTIMAL | QH       |
|---------|----------|---------|----------|---------|----------|
| 501 114 | QWB 520  | 602 320 | QWB 782  | 681 303 | QWB 974  |
| 501 114 | QWB 537  | 602 320 | QWB 799  | 681 325 | QWB 1005 |
| 501 136 | QWB 786  | 602 320 | QWB 870  | 681 504 | QWB 481  |
| 501 161 | QWB 1268 | 602 322 | QWB 635  | 681 506 | QWB 828  |
| 501 170 | QWB 684  | 602 322 | QWB 825  | 681 640 | QWB 486  |
| 501 184 | QWB 217  | 602 337 | QWB 1049 | 681 907 | QWB 586  |
| 501 194 | QWB 216  | 602 338 | QWB 679  | 681 919 | QWB 199C |
| 502 066 | QWB 514  | 602 338 | QWB 830  | 681 919 | QWB 585  |
| 502 068 | QWB 436  | 602 339 | QWB 1050 | 682 305 | QWB 1001 |
| 502 068 | QWB 906  | 602 340 | QWB 488  | 682 327 | QWB 996  |
| 502 070 | QWB 513  | 602 340 | QWB 500  | 682 329 | QWB 995  |
| 502 072 | QWB 779  | 602 340 | QWB 524  | 682 420 | QWB 483  |
| 502 134 | QWB 203  | 602 340 | QWB 589  | 682 422 | QWB 545  |
| 502 138 | QWB 787  | 602 341 | QWB 858  | 682 490 | QWB 650  |
| 502 148 | QWB 831  | 602 343 | QWB 930  | 682 492 | QWB 650  |
| 502 158 | QWB 778  | 602 344 | QWB 790  | 682 508 | QWB 739  |
| 502 163 | QWB 1269 | 602 344 | QWB 829  | 682 510 | QWB 740  |
| 502 178 | QWB 218  | 602 356 | QWB 776  | 682 642 | QWB 482  |
| 600 308 | QWB 525  | 602 358 | QWB 450  | 682 911 | QWB 1054 |
| 600 308 | QWB 781  | 602 367 | QWB 1051 | 682 920 | QWB 607  |
| 600 308 | QWB 835  | 602 388 | QWB 678  | 682 920 | QWB 613  |
| 600 308 | QWB 857  | 602 388 | QWB 858  | 682 921 | QWB 612  |
| 600 334 | QWB 634  | 602 388 | QWB 932  | 700 310 | QWB 564  |
| 600 334 | QWB 824  | 602 390 | QWB 461  | 700 310 | QWB 950  |
| 600 334 | QWB 833  | 602 392 | QWB 451  | 700 310 | QWB 1084 |
| 600 410 | QWB 224  | 602 406 | QWB 291  | 701 247 | QWB 1313 |
| 601 306 | QWB 487  | 602 412 | QWB 292  | 701 302 | QWB 430  |
| 601 306 | QWB 798  | 602 414 | QWB 459  | 701 307 | QWB 871  |
| 601 336 | QWB 489  | 602 416 | QWB 455  | 701 307 | QWB 950  |
| 601 336 | QWB 501  | 602 418 | QWB 228  | 701 319 | QWB 1087 |
| 601 348 | QWB 775  | 602 430 | QWB 610  | 701 326 | QWB 467  |
| 601 384 | QWB 289  | 602 430 | QWB 650  | 701 332 | QWB 313  |
| 601 384 | QWB 611  | 602 430 | QWB 791  | 701 346 | QWB 430  |
| 601 396 | QWB 630  | 602 512 | QWB 738  | 701 374 | QWB 302  |
| 601 434 | QWB 491  | 602 539 | QWB 554  | 701 404 | QWB 479  |
| 601 440 | QWB 227  | 602 541 | QWB 446  | 701 424 | QWB 498  |
| 601 446 | QWB 231  | 602 584 | QWB 476  | 701 432 | QWB 309  |
| 601 495 | QWB 507  | 602 815 | QWB 272  | 701 726 | QWB 474  |
| 601 502 | QWB 458  | 602 821 | QWB 448  | 701 728 | QWB 648  |
| 601 521 | QWB 110C | 602 833 | QWB 143C | 701 826 | QWB 286  |
| 601 580 | QWB 478  | 602 833 | QWB 148C | 701 852 | QWB 1083 |
| 601 582 | QWB 737  | 602 833 | QWB 154C | 701 860 | QWB 1085 |
| 601 654 | QWB 630  | 602 859 | QWB 445  | 701 914 | QWB 1096 |
| 601 828 | QWB 454  | 602 865 | QWB 229  | 702 309 | QWB 953  |
| 602 314 | QWB 839  | 602 881 | QWB 142C | 702 311 | QWB 872  |
| 602 314 | QWB 908  | 602 956 | QWB 1228 | 702 312 | QWB 431  |
| 602 320 | QWB 503  | 681 259 | QWB 1333 | 702 312 | QWB 1088 |

## VERGLEICHNUMMERNLISTE

### CROSS REFERENCE GUIDE / LISTE DES ÉQUIVALENCES

| OPTIMAL | QH       | OPTIMAL | QH       | OPTIMAL | QH       |
|---------|----------|---------|----------|---------|----------|
| 702 313 | QWB 954  | 801 364 | QWB 854  | 802 542 | QWB 672  |
| 702 316 | QWB 566  | 801 372 | QWB 551  | 802 556 | QWB 213  |
| 702 321 | QWB 1131 | 801 376 | QWB 794  | 802 558 | QWB 213  |
| 702 328 | QWB 310  | 801 382 | QWB 792  | 802 560 | QWB 901  |
| 702 350 | QWB 629  | 801 402 | QWB 242  | 802 562 | QWB 774  |
| 702 352 | QWB 662  | 801 428 | QWB 944  | 802 590 | QWB 822  |
| 702 355 | QWB 952  | 801 442 | QWB 676  | 802 620 | QWB 260  |
| 702 357 | QWB 951  | 801 450 | QWB 682  | 802 620 | QWB 551  |
| 702 359 | QWB 1091 | 801 478 | QWB 604  | 802 646 | QWB 441  |
| 702 365 | QWB 874  | 801 500 | QWB 846  | 802 652 | QWB 211  |
| 702 380 | QWB 563  | 801 500 | QWB 1118 | 802 652 | QWB 605  |
| 702 426 | QWB 560  | 801 538 | QWB 249  | 802 658 | QWB 677  |
| 702 426 | QWB 907  | 801 543 | QWB 811  | 802 720 | QWB 647  |
| 702 426 | QWB 951  | 801 554 | QWB 691  | 802 732 | QWB 707  |
| 702 426 | QWB 952  | 801 574 | QWB 239  | 802 740 | QWB 760  |
| 702 436 | QWB 475  | 801 588 | QWB 210  | 802 748 | QWB 685  |
| 702 448 | QWB 649  | 801 618 | QWB 493  | 802 839 | QWB 1101 |
| 702 452 | QWB 680  | 801 644 | QWB 666  | 880 419 | QWB 519  |
| 702 456 | QWB 497  | 801 656 | QWB 725  | 880 419 | QWB 706  |
| 702 462 | QWB 480  | 801 694 | QWB 811  | 880 421 | QWB 706  |
| 702 494 | QWB 1133 | 801 698 | QWB 247  | 880 525 | QWB 191C |
| 702 514 | QWB 681  | 801 730 | QWB 853  | 880 525 | QWB 192C |
| 702 537 | QWB 1048 | 801 750 | QWB 666  | 880 812 | QWB 186C |
| 702 550 | QWB 565  | 801 836 | QWB 1102 | 880 812 | QWB 187C |
| 702 552 | QWB 687  | 801 838 | QWB 1097 | 880 812 | QWB 419  |
| 702 586 | QWB 942  | 801 922 | QWB 240  | 880 812 | QWB 519  |
| 702 692 | QWB 608  | 801 950 | QWB 1098 | 880 912 | QWB 1116 |
| 702 817 | QWB 629  | 801 961 | QWB 1320 | 881 489 | QWB 701  |
| 702 846 | QWB 1086 | 802 271 | QWB 1321 | 881 507 | QWB 425  |
| 702 850 | QWB 1092 | 802 315 | QWB 964  | 881 523 | QWB 157C |
| 702 866 | QWB 1132 | 802 318 | QWB 421  | 881 523 | QWB 170C |
| 702 957 | QWB 1277 | 802 324 | QWB 673  | 881 527 | QWB 126C |
| 702 983 | QWB 1332 | 802 330 | QWB 736  | 881 529 | QWB 129C |
| 800 304 | QWB 422  | 802 368 | QWB 574  | 881 534 | QWB 594  |
| 800 366 | QWB 422  | 802 368 | QWB 902  | 881 564 | QWB 197C |
| 800 398 | QWB 795  | 802 370 | QWB 575  | 881 592 | QWB 159C |
| 800 398 | QWB 853  | 802 370 | QWB 856  | 881 594 | QWB 661  |
| 800 398 | QWB 944  | 802 378 | QWB 734  | 881 609 | QWB 644  |
| 800 400 | QWB 735  | 802 394 | QWB 509  | 881 622 | QWB 562  |
| 800 400 | QWB 848  | 802 444 | QWB 844  | 881 704 | QWB 743  |
| 800 408 | QWB 243  | 802 454 | QWB 254  | 881 704 | QWB 819  |
| 801 238 | QWB 214  | 802 464 | QWB 241  | 881 871 | QWB 122C |
| 801 267 | QWB 1334 | 802 480 | QWB 238  | 881 879 | QWB 427  |
| 801 342 | QWB 515  | 802 485 | QWB 1071 | 882 463 | QWB 911  |
| 801 354 | QWB 422  | 802 488 | QWB 800  | 882 487 | QWB 1124 |
| 801 360 | QWB 674  | 802 528 | QWB 800  | 882 491 | QWB 708  |
| 801 362 | QWB 855  | 802 540 | QWB 671  | 882 531 | QWB 163C |

## VERGLEICHNUMMERNLISTE

### CROSS REFERENCE GUIDE / LISTE DES ÉQUIVALENCES

| OPTIMAL | QH       | OPTIMAL | QH       | OPTIMAL | QH       |
|---------|----------|---------|----------|---------|----------|
| 882 531 | QWB 541  | 901 461 | QWB 580  | 941 511 | QWB 601  |
| 882 598 | QWB 910  | 902 457 | QWB 641  | 941 565 | QWB 628  |
| 882 611 | QWB 643  | 902 459 | QWB 640  | 941 602 | QWB 780  |
| 882 613 | QWB 642  | 911 375 | QWB 886  | 941 617 | QWB 717  |
| 882 624 | QWB 804  | 911 375 | QWB 917  | 941 634 | QWB 469  |
| 882 626 | QWB 836  | 911 383 | QWB 887  | 941 636 | QWB 722  |
| 882 643 | QWB 499  | 911 385 | QWB 965  | 941 700 | QWB 890  |
| 882 664 | QWB 435  | 911 387 | QWB 966  | 941 700 | QWB 891  |
| 882 666 | QWB 137C | 911 399 | QWB 1023 | 941 734 | QWB 619  |
| 882 729 | QWB 973  | 911 513 | QWB 426  | 941 786 | QWB 449  |
| 882 819 | QWB 104C | 911 600 | QWB 490  | 941 873 | QWB 449  |
| 882 861 | QWB 133C | 911 600 | QWB 616  | 942 566 | QWB 602  |
| 882 863 | QWB 167C | 911 621 | QWB 462  | 942 568 | QWB 723  |
| 882 875 | QWB 440  | 911 623 | QWB 712  | 942 569 | QWB 891  |
| 891 466 | QWB 1120 | 911 625 | QWB 820  | 942 570 | QWB 724  |
| 891 482 | QWB 690  | 911 629 | QWB 841  | 942 619 | QWB 940  |
| 891 484 | QWB 759  | 911 782 | QWB 821  | 942 672 | QWB 745  |
| 891 509 | QWB 326  | 911 802 | QWB 1278 | 942 672 | QWB 851  |
| 891 520 | QWB 558  | 912 401 | QWB 1066 | 942 672 | QWB 918  |
| 891 520 | QWB 881  | 912 403 | QWB 1066 | 942 674 | QWB 470  |
| 891 522 | QWB 465  | 912 471 | QWB 591  | 942 738 | QWB 762  |
| 891 524 | QWB 689  | 912 505 | QWB 264  | 942 754 | QWB 727  |
| 891 536 | QWB 1119 | 912 515 | QWB 424  | 942 754 | QWB 730  |
| 891 546 | QWB 663  | 912 515 | QWB 535  | 942 768 | QWB 699  |
| 891 628 | QWB 1039 | 912 518 | QWB 967  | 942 770 | QWB 700  |
| 891 630 | QWB 878  | 912 530 | QWB 592  | 942 773 | QWB 921  |
| 891 706 | QWB 598  | 912 530 | QWB 618  | 942 788 | QWB 235  |
| 891 822 | QWB 516  | 912 530 | QWB 843  | 942 818 | QWB 809  |
| 892 458 | QWB 599  | 912 530 | QWB 850  | 942 820 | QWB 810  |
| 892 460 | QWB 337  | 912 532 | QWB 742  | 951 604 | QWB 957  |
| 892 468 | QWB 882  | 912 532 | QWB 805  | 951 604 | QWB 958  |
| 892 470 | QWB 726  | 912 532 | QWB 909  | 951 606 | QWB 746  |
| 892 472 | QWB 971  | 912 775 | QWB 966  | 951 606 | QWB 999  |
| 892 474 | QWB 651  | 912 803 | QWB 1094 | 951 708 | QWB 692  |
| 892 476 | QWB 688  | 912 804 | QWB 1165 | 951 722 | QWB 716  |
| 892 498 | QWB 849  | 920 752 | QWB 375  | 951 756 | QWB 695  |
| 892 668 | QWB 665  | 920 752 | QWB 638  | 952 405 | QWB 984  |
| 892 670 | QWB 664  | 922 439 | QWB 555  | 952 415 | QWB 988  |
| 892 733 | QWB 883  | 922 781 | QWB 1081 | 952 415 | QWB 989  |
| 892 735 | QWB 1039 | 922 783 | QWB 1079 | 952 593 | QWB 645  |
| 892 802 | QWB 655  | 922 797 | QWB 713  | 952 608 | QWB 842  |
| 892 804 | QWB 381  | 922 799 | QWB 711  | 952 608 | QWB 926  |
| 892 804 | QWB 615  | 931 877 | QWB 806  | 952 661 | QWB 747  |
| 892 830 | QWB 456  | 932 794 | QWB 709  | 952 676 | QWB 1073 |
| 901 425 | QWB 884  | 940 371 | QWB 889  | 952 678 | QWB 1072 |
| 901 429 | QWB 924  | 940 632 | QWB 721  | 952 679 | QWB 620  |
| 901 445 | QWB 617  | 941 497 | QWB 552  | 952 710 | QWB 803  |



## VERGLEICHNUMMERNLISTE

### CROSS REFERENCE GUIDE / LISTE DES ÉQUIVALENCES

| OPTIMAL | QH       | OPTIMAL | QH       | OPTIMAL | RUL - SNR |
|---------|----------|---------|----------|---------|-----------|
| 952 758 | QWB 748  | 972 633 | QWB 710  | 100 002 | R154.13   |
| 960 578 | QWB 931  | 972 688 | QWB 785  | 100 003 | R154.10   |
| 960 638 | QWB 956  | 972 709 | QWB 916  | 100 014 | R154.26   |
| 960 702 | QWB 727  | 981 447 | QWB 444  | 100 022 | R154.28   |
| 961 503 | QWB 347  | 981 475 | QWB 899  | 100 022 | R154.38   |
| 961 576 | QWB 557  | 981 475 | QWB 900  | 100 036 | R157.07   |
| 961 610 | QWB 938  | 981 535 | QWB 361  | 100 053 | R157.26   |
| 961 648 | QWB 928  | 981 572 | QWB 636  | 100 056 | R157.06   |
| 961 680 | QWB 538  | 981 572 | QWB 702  | 100 090 | R157.08   |
| 961 701 | QWB 956  | 981 616 | QWB 623  | 100 093 | R157.13   |
| 961 724 | QWB 344  | 981 616 | QWB 766  | 100 098 | R157.14   |
| 961 765 | QWB 656  | 981 616 | QWB 847  | 100 098 | R157.18   |
| 961 796 | QWB 355  | 981 690 | QWB 934  | 100 098 | R157.21   |
| 961 808 | QWB 579  | 981 742 | QWB 768  | 100 099 | R157.09   |
| 961 883 | QWB 614  | 981 744 | QWB 767  | 100 099 | R157.11   |
| 961 904 | QWB 815  | 981 790 | QWB 366  | 100 206 | R154.33   |
| 962 435 | QWB 658  | 981 790 | QWB 625  | 101 010 | R154.14   |
| 962 517 | QWB 349  | 981 798 | QWB 365  | 101 016 | R154.23   |
| 962 548 | QWB 939  | 981 814 | QWB 444  | 101 024 | R154.34   |
| 962 682 | QWB 539  | 981 814 | QWB 705  | 101 029 | R154.52   |
| 962 684 | QWB 354  | 981 944 | QWB 900  | 101 044 | R154.12   |
| 962 686 | QWB 600  | 981 947 | QWB 1129 | 101 064 | R154.17   |
| 962 703 | QWB 933  | 981 952 | QWB 1123 | 101 102 | R154.20   |
| 962 712 | QWB 1136 | 982 379 | QWB 883  | 101 108 | R154.24   |
| 962 716 | QWB 764  | 982 379 | QWB 897  | 101 110 | R154.22   |
| 962 718 | QWB 763  | 982 431 | QWB 898  | 101 111 | R157.16   |
| 962 760 | QWB 581  | 982 561 | QWB 1053 | 101 111 | R157.17   |
| 962 760 | QWB 582  | 982 650 | QWB 367  | 101 113 | R157.22   |
| 962 760 | QWB 732  | 982 737 | QWB 978  | 101 128 | R154.32   |
| 962 762 | QWB 731  | 982 764 | QWB 360  | 101 145 | R154.06   |
| 962 776 | QWB 492  | 982 766 | QWB 622  | 101 147 | R154.15   |
| 962 776 | QWB 556  | 982 766 | QWB 703  | 101 250 | R167.06   |
| 962 779 | QWB 922  | 982 778 | QWB 637  | 101 264 | R167.05   |
| 962 847 | QWB 656  | 982 780 | QWB 621  | 101 270 | R167.03   |
| 962 853 | QWB 922  | 982 780 | QWB 704  | 102 008 | R157.05   |
| 962 899 | QWB 816  | 982 816 | QWB 597  | 102 011 | R154.44   |
| 962 905 | QWB 816  | 982 857 | QWB 1052 | 102 019 | R154.55   |
| 962 949 | QWB 354  | 982 945 | QWB 360  | 102 041 | R157.25   |
| 971 451 | QWB 915  | 991 655 | QWB 1172 | 102 054 | R154.19   |
| 971 455 | QWB 896  | 991 657 | QWB 1173 | 102 055 | R154.50   |
| 971 567 | QWB 962  | 991 749 | QWB 1174 | 102 060 | R154.18   |
| 971 612 | QWB 812  | 991 902 | QWB 892  | 102 069 | R154.51   |
| 971 615 | QWB 714  | 992 659 | QWB 1175 | 102 071 | R157.27   |
| 971 627 | QWB 977  | 992 663 | QWB 1176 | 102 077 | R157.31   |
| 971 707 | QWB 943  | 992 689 | QWB 1178 | 102 079 | R182.61   |
| 972 465 | QWB 814  | 992 894 | QWB 893  | 102 094 | R154.08   |
| 972 573 | QWB 904  | 992 922 | QWB 1177 | 102 097 | R157.28   |

## VERGLEICHNUMMERNLISTE

### CROSS REFERENCE GUIDE / LISTE DES ÉQUIVALENCES

| OPTIMAL | RUL - SNR | OPTIMAL | RUL - SNR | OPTIMAL | RUL - SNR |
|---------|-----------|---------|-----------|---------|-----------|
| 102 115 | R157.20   | 202 252 | R153.06   | 302 174 | R140.69   |
| 102 150 | R154.31   | 202 519 | R153.41   | 302 176 | R140.70   |
| 102 152 | R154.36   | 202 625 | R153.50   | 302 186 | R152.43   |
| 102 154 | R154.37   | 202 627 | R153.49   | 302 188 | R152.44   |
| 102 156 | R154.39   | 300 004 | R152.17   | 302 190 | R152.47   |
| 102 213 | R154.54   | 300 052 | R152.12   | 302 192 | R152.45   |
| 102 266 | R154.09   | 300 062 | R152.02   | 302 196 | R152.46   |
| 102 268 | R167.04   | 301 006 | R152.19   | 302 197 | R152.24   |
| 131 129 | R154.41   | 301 018 | R152.16   | 302 234 | R152.13   |
| 132 131 | R154.42   | 301 034 | R152.21   | 302 240 | R140.67   |
| 190 256 | R169.15   | 301 038 | R152.29   | 302 248 | R152.40   |
| 191 258 | R169.33   | 301 039 | R152.54   | 302 254 | R152.09   |
| 191 272 | R140.26   | 301 045 | R152.55   | 302 255 | R152.58   |
| 192 274 | R140.27   | 301 118 | R140.87   | 302 257 | R152.59   |
| 200 012 | R153.07   | 301 130 | R152.35   | 302 260 | R152.41   |
| 200 020 | R153.16   | 301 132 | R152.39   | 400 051 | R151.26   |
| 201 031 | R153.30   | 301 139 | R152.50   | 400 061 | R151.33   |
| 201 032 | R153.15   | 301 141 | R152.51   | 400 107 | R151.27   |
| 201 033 | R153.31   | 301 151 | R152.05   | 401 028 | R151.05   |
| 201 035 | R153.32   | 301 180 | R152.36   | 401 042 | R151.14   |
| 201 040 | R153.14   | 301 182 | R152.42   | 401 047 | R151.31   |
| 201 043 | R153.33   | 301 185 | R152.60   | 401 048 | R151.08   |
| 201 084 | R153.19   | 301 198 | R152.48   | 401 078 | R151.18   |
| 201 087 | R153.35   | 301 200 | R152.49   | 401 078 | R151.24   |
| 201 089 | R155.69   | 301 230 | R152.20   | 401 082 | R151.20   |
| 201 095 | R153.39   | 301 232 | R152.18   | 401 083 | R151.35   |
| 201 210 | R153.25   | 301 244 | R152.30   | 401 096 | R151.17   |
| 201 228 | R153.26   | 301 246 | R152.31   | 401 100 | R151.11   |
| 201 262 | R153.28   | 301 280 | R152.08   | 401 104 | R151.09   |
| 201 262 | R153.28   | 301 511 | R152.61   | 401 126 | R151.12   |
| 201 621 | R153.47   | 301 667 | R152.62   | 401 137 | R140.76   |
| 201 623 | R153.48   | 302 037 | R152.53   | 401 157 | R151.36   |
| 202 021 | R153.37   | 302 046 | R152.22   | 401 212 | R151.23   |
| 202 023 | R153.38   | 302 057 | R152.56   | 401 214 | R140.72   |
| 202 026 | R153.24   | 302 058 | R152.37   | 401 222 | R151.02   |
| 202 059 | R153.34   | 302 067 | R152.52   | 401 276 | R151.00   |
| 202 101 | R155.70   | 302 074 | R152.28   | 401 277 | R151.06   |
| 202 140 | R153.22   | 302 076 | R152.34   | 401 501 | R151.38   |
| 202 142 | R153.23   | 302 120 | R152.32   | 402 030 | R151.03   |
| 202 168 | R153.20   | 302 122 | R152.33   | 402 050 | R151.10   |
| 202 202 | R153.08   | 302 124 | R140.80   | 402 063 | R151.32   |
| 202 204 | R153.09   | 302 146 | R152.10   | 402 080 | R151.15   |
| 202 218 | R153.27   | 302 160 | R140.53   | 402 080 | R151.16   |
| 202 218 | R164.16   | 302 162 | R140.68   | 402 116 | R151.07   |
| 202 218 | R164.17   | 302 164 | R140.86   | 402 116 | R151.13   |
| 202 226 | R153.13   | 302 166 | R140.85   | 402 116 | R151.19   |
| 202 236 | R153.10   | 302 172 | R140.52   | 402 117 | R154.46   |

## VERGLEICHNUMMERNLISTE

### CROSS REFERENCE GUIDE / LISTE DES ÉQUIVALENCES

| OPTIMAL | RUL - SNR | OPTIMAL | RUL - SNR | OPTIMAL | RUL - SNR |
|---------|-----------|---------|-----------|---------|-----------|
| 402 119 | R154.47   | 601 495 | R159.07   | 602 865 | R166.19   |
| 402 143 | R140.88   | 601 502 | R166.10   | 602 937 | R159.26   |
| 402 159 | R151.41   | 601 580 | R140.18   | 602 956 | R159.42   |
| 402 216 | R140.73   | 601 582 | R166.17   | 681 259 | R158.15   |
| 402 242 | R151.21   | 601 654 | R159.05   | 681 261 | R159.45   |
| 402 242 | R151.22   | 601 675 | R159.47   | 681 303 | R159.31   |
| 501 088 | R150.15   | 601 828 | R166.02   | 681 325 | R140.94   |
| 501 088 | R150.17   | 601 916 | R159.17   | 681 471 | R140.38   |
| 501 092 | R150.09   | 602 249 | R159.39   | 681 504 | R140.42   |
| 501 112 | R150.17   | 602 251 | R166.32   | 681 506 | R140.77   |
| 501 114 | R150.11   | 602 314 | R159.29   | 681 640 | R140.02   |
| 501 121 | R150.30   | 602 320 | R159.19   | 682 263 | R159.46   |
| 501 133 | R150.26   | 602 322 | R166.15   | 682 305 | R159.32   |
| 501 136 | R150.22   | 602 337 | R166.24   | 682 327 | R140.95   |
| 501 158 | R150.33   | 602 338 | R159.23   | 682 329 | R140.96   |
| 501 161 | R162.50   | 602 339 | R166.23   | 682 420 | R140.43   |
| 501 170 | R150.20   | 602 340 | R159.15   | 682 422 | R140.44   |
| 501 184 | R150.00   | 602 341 | R166.25   | 682 490 | R140.84   |
| 501 194 | R150.02   | 602 343 | R159.34   | 682 492 | R140.83   |
| 501 513 | R150.40   | 602 344 | R159.26   | 682 508 | R140.78   |
| 502 066 | R150.12   | 602 345 | R159.33   | 682 510 | R140.79   |
| 502 068 | R150.16   | 602 347 | R166.26   | 682 642 | R140.03   |
| 502 070 | R150.10   | 602 349 | R166.27   | 700 245 | R155.72   |
| 502 072 | R150.19   | 602 356 | R166.21   | 700 310 | R155.16   |
| 502 109 | R150.31   | 602 358 | R166.05   | 701 247 | R155.74   |
| 502 123 | R150.29   | 602 361 | R159.30   | 701 302 | R155.12   |
| 502 125 | R150.28   | 602 367 | R159.36   | 701 302 | R155.32   |
| 502 134 | R150.03   | 602 369 | R159.35   | 701 307 | R155.38   |
| 502 135 | R150.27   | 602 388 | R159.22   | 701 307 | R155.44   |
| 502 138 | R150.23   | 602 390 | R159.13   | 701 319 | R155.12   |
| 502 148 | R150.24   | 602 392 | R166.09   | 701 326 | R155.11   |
| 502 158 | R150.14   | 602 406 | R159.03   | 701 332 | R155.08   |
| 502 163 | R162.51   | 602 412 | R159.02   | 701 346 | R155.16   |
| 502 178 | R150.07   | 602 414 | R159.12   | 701 374 | R155.10   |
| 600 308 | R166.13   | 602 416 | R166.03   | 701 404 | R155.09   |
| 600 334 | R166.14   | 602 418 | R166.01   | 701 424 | R155.14   |
| 600 410 | R156.00   | 602 430 | R159.20   | 701 432 | R155.21   |
| 601 253 | R166.03   | 602 512 | R166.18   | 701 726 | R140.23   |
| 601 306 | R159.14   | 602 539 | R159.21   | 701 728 | R140.57   |
| 601 323 | R166.28   | 602 541 | R159.04   | 701 826 | R155.01   |
| 601 336 | R166.11   | 602 584 | R140.19   | 701 852 | R155.52   |
| 601 348 | R159.24   | 602 681 | R159.49   | 701 860 | R155.64   |
| 601 384 | R159.08   | 602 815 | R166.06   | 701 914 | R155.61   |
| 601 396 | R159.10   | 602 821 | R159.09   | 701 975 | R155.07   |
| 601 434 | R166.08   | 602 833 | R152.06   | 701 977 | R155.75   |
| 601 440 | R166.00   | 602 858 | R159.38   | 701 978 | R155.76   |
| 601 446 | R156.04   | 602 859 | R159.11   | 702 309 | R155.39   |

## VERGLEICHNUMMERNLISTE

### CROSS REFERENCE GUIDE / LISTE DES ÉQUIVALENCES

| OPTIMAL | RUL - SNR | OPTIMAL | RUL - SNR | OPTIMAL | RUL - SNR |
|---------|-----------|---------|-----------|---------|-----------|
| 702 311 | R155.41   | 800 408 | R158.07   | 802 368 | R158.20   |
| 702 311 | R155.43   | 801 238 | R160.00   | 802 370 | R158.19   |
| 702 312 | R155.13   | 801 267 | R158.55   | 802 378 | R158.21   |
| 702 312 | R155.63   | 801 342 | R158.13   | 802 394 | R158.14   |
| 702 313 | R155.42   | 801 354 | R182.60   | 802 444 | R158.29   |
| 702 316 | R155.17   | 801 360 | R158.24   | 802 454 | R172.00   |
| 702 321 | R155.56   | 801 362 | R158.35   | 802 464 | R158.04   |
| 702 328 | R155.06   | 801 364 | R158.34   | 802 480 | R158.11   |
| 702 350 | R155.22   | 801 372 | R176.00   | 802 485 | R160.23   |
| 702 351 | R155.50   | 801 376 | R158.31   | 802 488 | R160.09   |
| 702 352 | R155.19   | 801 382 | R158.30   | 802 526 | R158.33   |
| 702 353 | R155.49   | 801 402 | R158.01   | 802 528 | R160.21   |
| 702 355 | R155.47   | 801 428 | R160.18   | 802 540 | R160.14   |
| 702 357 | R155.46   | 801 438 | R160.06   | 802 542 | R160.13   |
| 702 359 | R155.51   | 801 442 | R172.03   | 802 556 | R160.07   |
| 702 363 | R155.45   | 801 450 | R158.25   | 802 558 | R160.12   |
| 702 365 | R155.48   | 801 478 | R160.08   | 802 560 | R160.16   |
| 702 380 | R155.15   | 801 500 | R160.20   | 802 562 | R160.17   |
| 702 380 | R155.25   | 801 538 | R158.02   | 802 590 | R172.02   |
| 702 426 | R155.27   | 801 543 | R154.49   | 802 620 | R176.00   |
| 702 436 | R140.24   | 801 554 | R160.19   | 802 646 | R160.03   |
| 702 448 | R140.47   | 801 574 | R158.00   | 802 652 | R160.02   |
| 702 452 | R155.18   | 801 588 | R160.01   | 802 658 | R172.04   |
| 702 456 | R140.25   | 801 618 | R178.00   | 802 660 | R140.33   |
| 702 462 | R140.46   | 801 644 | R140.59   | 802 662 | R140.32   |
| 702 494 | R155.26   | 801 656 | R172.01   | 802 720 | R178.01   |
| 702 514 | R155.24   | 801 694 | R178.02   | 802 732 | R178.03   |
| 702 537 | R155.53   | 801 698 | R158.08   | 802 740 | R140.66   |
| 702 550 | R155.23   | 801 730 | R158.37   | 802 748 | R140.65   |
| 702 552 | R155.28   | 801 746 | R140.29   | 802 839 | R158.46   |
| 702 586 | R140.81   | 801 750 | R140.58   | 802 870 | R160.26   |
| 702 603 | KF155.73  | 801 836 | R158.44   | 802 886 | R176.02   |
| 702 692 | R140.56   | 801 838 | R158.43   | 802 888 | R160.27   |
| 702 817 | R155.03   | 801 880 | R158.41   | 880 419 | R180.01   |
| 702 846 | R155.65   | 801 922 | R158.03   | 880 421 | R180.02   |
| 702 850 | R155.60   | 801 961 | R160.30   | 880 525 | R161.05   |
| 702 866 | R155.54   | 801 970 | R160.25   | 880 812 | R180.00   |
| 702 915 | R155.98   | 801 972 | R158.45   | 880 912 | R161.03   |
| 702 957 | R155.67   | 801 974 | R158.54   | 881 489 | R183.03   |
| 702 958 | R155.66   | 802 271 | R158.52   | 881 507 | R161.00   |
| 702 960 | R155.55   | 802 315 | R158.39   | 881 534 | R161.08   |
| 702 976 | KF155.81S | 802 318 | R158.10   | 881 564 | R183.00   |
| 702 982 | R155.77   | 802 324 | R158.17   | 881 592 | R161.09   |
| 800 304 | R158.12   | 802 330 | R158.22   | 881 594 | R161.10   |
| 800 366 | R158.28   | 802 330 | R158.23   | 881 622 | R161.06   |
| 800 398 | R158.36   | 802 331 | R176.06   | 881 704 | R174.12   |
| 800 400 | R158.18   | 802 335 | R160.22   | 881 725 | R161.23   |

## VERGLEICHSDATENLISTE

### CROSS REFERENCE GUIDE / LISTE DES ÉQUIVALENCES

| OPTIMAL | RUL - SNR | OPTIMAL | RUL - SNR | OPTIMAL | RUL - SNR |
|---------|-----------|---------|-----------|---------|-----------|
| 882 463 | R161.01   | 892 733 | R165.19   | 912 775 | R174.26   |
| 882 483 | R161.19   | 892 735 | R165.20   | 912 803 | R174.38   |
| 882 487 | R161.22   | 892 802 | R165.06   | 920 752 | R173.00   |
| 882 491 | R183.02   | 892 804 | R163.02   | 922 439 | R184.00   |
| 882 598 | R161.01   | 892 806 | R164.07   | 922 441 | R184.01   |
| 882 607 | R161.16   | 892 830 | R164.06   | 922 781 | R184.02   |
| 882 624 | R161.20   | 892 843 | R165.22   | 922 783 | R184.03   |
| 882 626 | R161.21   | 892 872 | R165.28   | 922 882 | R184.04   |
| 882 643 | R161.11   | 901 425 | R179.07   | 940 371 | R170.32   |
| 882 664 | R161.07   | 901 425 | R179.12   | 940 632 | R170.14   |
| 882 666 | R183.01   | 901 427 | R179.06   | 941 497 | R170.02   |
| 882 727 | R161.18   | 901 429 | R179.08   | 941 511 | R140.30   |
| 882 729 | R161.17   | 901 429 | R179.13   | 941 565 | R140.82   |
| 882 819 | R161.02   | 901 461 | R179.00   | 941 602 | R170.15   |
| 891 333 | R165.21   | 901 549 | R179.11   | 941 617 | R170.19   |
| 891 466 | R165.14   | 902 443 | R179.14   | 941 634 | R170.04   |
| 891 469 | R165.23   | 902 457 | R179.03   | 941 636 | R170.09   |
| 891 477 | R165.24   | 902 459 | R179.01   | 941 700 | R170.22   |
| 891 482 | R165.21   | 902 547 | R179.16   | 941 734 | R170.07   |
| 891 484 | R165.11   | 902 771 | R179.15   | 941 784 | R170.27   |
| 891 486 | R165.16   | 902 855 | R179.17   | 941 786 | R170.03   |
| 891 496 | R164.13   | 911 375 | R174.08   | 941 842 | R170.25   |
| 891 509 | R164.03   | 911 375 | R174.10   | 941 862 | R170.31   |
| 891 520 | R165.07   | 911 377 | R174.25   | 941 874 | R170.26   |
| 891 522 | R165.04   | 911 383 | R174.34   | 941 951 | R170.33   |
| 891 524 | R164.08   | 911 385 | R174.28   | 942 381 | R170.30   |
| 891 536 | R165.13   | 911 387 | R174.29   | 942 501 | R170.06   |
| 891 544 | R165.18   | 911 399 | R174.33   | 942 566 | R170.08   |
| 891 546 | R164.10   | 911 513 | R174.03   | 942 568 | R170.11   |
| 891 628 | R165.17   | 911 513 | R174.04   | 942 569 | R170.23   |
| 891 630 | R164.15   | 911 600 | R174.13   | 942 570 | R170.10   |
| 891 706 | R164.05   | 911 621 | R174.05   | 942 619 | R170.21   |
| 891 731 | R165.25   | 911 623 | R174.21   | 942 672 | R170.16   |
| 891 822 | R163.00   | 911 625 | R174.05   | 942 674 | R170.05   |
| 891 869 | R165.26   | 911 777 | R174.30   | 942 736 | R170.28   |
| 891 878 | R165.27   | 911 782 | R174.06   | 942 738 | R170.20   |
| 891 887 | R164.18   | 912 401 | R174.39   | 942 754 | R140.31   |
| 892 458 | R165.05   | 912 403 | R174.32   | 942 768 | R170.13   |
| 892 460 | R165.03   | 912 423 | R174.24   | 942 770 | R170.12   |
| 892 468 | R165.09   | 912 471 | R174.20   | 942 773 | R170.24   |
| 892 470 | R165.10   | 912 473 | R174.17   | 942 788 | R170.01   |
| 892 472 | R165.15   | 912 505 | R174.02   | 942 818 | R170.17   |
| 892 474 | R165.08   | 912 515 | R174.09   | 942 820 | R170.18   |
| 892 476 | R164.11   | 912 527 | R174.14   | 951 449 | R173.10   |
| 892 498 | R164.14   | 912 530 | R174.19   | 951 519 | R173.03   |
| 892 668 | R164.12   | 912 532 | R174.16   | 951 604 | R173.14   |
| 892 670 | R164.09   | 912 545 | R174.31   | 951 606 | R173.08   |



## VERGLEICHSDATUMMERNLISTE

### CROSS REFERENCE GUIDE / LISTE DES ÉQUIVALENCES

| OPTIMAL | RUVILLE | OPTIMAL | RUVILLE | OPTIMAL | RUVILLE |
|---------|---------|---------|---------|---------|---------|
| 100 013 | 5458    | 101 145 | 5406    | 201 043 | 5333    |
| 100 013 | 5459    | 101 147 | 5415    | 201 084 | 5318    |
| 100 013 | 5462    | 101 209 | 4097    | 201 084 | 5319    |
| 100 014 | 5416    | 101 250 | 6706    | 201 085 | 4099    |
| 100 014 | 5426    | 101 264 | 6705    | 201 085 | 5571    |
| 100 022 | 5428    | 101 270 | 6703    | 201 087 | 5335    |
| 100 022 | 5429    | 102 008 | 5705    | 201 089 | 5569    |
| 100 022 | 5438    | 102 008 | 5712    | 201 095 | 5339    |
| 100 036 | 5704    | 102 008 | 5715    | 201 210 | 5325    |
| 100 036 | 5707    | 102 011 | 5444    | 201 228 | 5326    |
| 100 053 | 5726    | 102 019 | 5455    | 201 262 | 5328    |
| 100 056 | 5706    | 102 041 | 5725    | 201 262 | 5342    |
| 100 056 | 5710    | 102 054 | 5419    | 201 517 | 5340    |
| 100 090 | 5708    | 102 055 | 5450    | 201 621 | 5347    |
| 100 091 | 5719    | 102 060 | 5418    | 201 623 | 5348    |
| 100 091 | 5723    | 102 069 | 5451    | 202 021 | 5337    |
| 100 093 | 5713    | 102 071 | 5727    | 202 023 | 5338    |
| 100 098 | 5443    | 102 075 | 5445    | 202 026 | 5324    |
| 100 098 | 5714    | 102 075 | 5461    | 202 059 | 5334    |
| 100 098 | 5718    | 102 077 | 5731    | 202 101 | 5570    |
| 100 098 | 5721    | 102 079 | 8261    | 202 140 | 5322    |
| 100 098 | 5724    | 102 094 | 5408    | 202 142 | 5323    |
| 100 098 | 5730    | 102 097 | 5728    | 202 168 | 5320    |
| 100 099 | 5709    | 102 103 | 6702    | 202 202 | 5308    |
| 100 099 | 5711    | 102 115 | 5448    | 202 204 | 5309    |
| 100 206 | 5433    | 102 115 | 5720    | 202 205 | 5329    |
| 101 010 | 5414    | 102 150 | 5431    | 202 218 | 5327    |
| 101 016 | 5423    | 102 152 | 5436    | 202 218 | 6416    |
| 101 016 | 5440    | 102 154 | 5437    | 202 218 | 6417    |
| 101 017 | 5456    | 102 156 | 5439    | 202 224 | 5336    |
| 101 024 | 5434    | 102 207 | 4098    | 202 226 | 5313    |
| 101 024 | 5435    | 102 213 | 5454    | 202 236 | 5310    |
| 101 025 | 7805    | 102 266 | 5409    | 202 252 | 5306    |
| 101 027 | 5732    | 102 268 | 6704    | 202 519 | 5341    |
| 101 029 | 5452    | 131 129 | 5441    | 202 625 | 5350    |
| 101 029 | 5733    | 132 131 | 5442    | 202 627 | 5349    |
| 101 044 | 5412    | 190 256 | 6915    | 300 004 | 5217    |
| 101 064 | 5417    | 191 258 | 6933    | 300 052 | 5212    |
| 101 102 | 5420    | 191 272 | 4026    | 300 062 | 5202    |
| 101 105 | 5427    | 192 274 | 4027    | 301 006 | 5219    |
| 101 108 | 5424    | 200 012 | 5307    | 301 018 | 5216    |
| 101 110 | 5422    | 200 020 | 5316    | 301 034 | 5221    |
| 101 111 | 5716    | 201 031 | 5330    | 301 038 | 5229    |
| 101 111 | 5717    | 201 032 | 5315    | 301 039 | 5254    |
| 101 113 | 5401    | 201 033 | 5331    | 301 045 | 5255    |
| 101 113 | 5722    | 201 035 | 5332    | 301 118 | 4087    |
| 101 128 | 5432    | 201 040 | 5314    | 301 130 | 5235    |

## VERGLEICHNUMMERNLISTE

### CROSS REFERENCE GUIDE / LISTE DES ÉQUIVALENCES

| OPTIMAL | RUVILLE | OPTIMAL | RUVILLE | OPTIMAL | RUVILLE |
|---------|---------|---------|---------|---------|---------|
| 301 132 | 5239    | 302 254 | 5209    | 402 116 | 5119    |
| 301 132 | 5257    | 302 255 | 5258    | 402 116 | 5129    |
| 301 139 | 5250    | 302 257 | 5259    | 402 117 | 5446    |
| 301 141 | 5251    | 302 260 | 5241    | 402 119 | 5447    |
| 301 151 | 5205    | 400 051 | 5126    | 402 143 | 4088    |
| 301 180 | 5236    | 400 061 | 5133    | 402 159 | 5141    |
| 301 182 | 5242    | 400 107 | 5127    | 402 216 | 4073    |
| 301 183 | 5223    | 401 028 | 5105    | 402 242 | 5121    |
| 301 185 | 5260    | 401 028 | 5105S   | 402 242 | 5122    |
| 301 198 | 5248    | 401 042 | 5114    | 402 242 | 5125    |
| 301 200 | 5249    | 401 042 | 5114S   | 402 243 | 5128    |
| 301 230 | 5220    | 401 047 | 5131    | 402 243 | 5130    |
| 301 232 | 5218    | 401 048 | 5108    | 402 301 | 8702    |
| 301 244 | 5230    | 401 048 | 5108S   | 402 505 | 5137    |
| 301 246 | 5231    | 401 078 | 5118    | 402 827 | 5145    |
| 301 280 | 5208    | 401 078 | 5124    | 501 088 | 5015    |
| 301 511 | 5261    | 401 082 | 5120    | 501 088 | 5017    |
| 301 667 | 5262    | 401 083 | 5135    | 501 092 | 5009    |
| 302 037 | 5253    | 401 096 | 5117    | 501 112 | 5017    |
| 302 046 | 5222    | 401 100 | 5111    | 501 114 | 5011    |
| 302 057 | 5256    | 401 104 | 5109    | 501 114 | 5013    |
| 302 058 | 5237    | 401 126 | 5112    | 501 121 | 5030    |
| 302 058 | 5237S   | 401 126 | 5112S   | 501 121 | 5036    |
| 302 058 | 5238    | 401 137 | 4076    | 501 133 | 5026    |
| 302 067 | 5252    | 401 157 | 5136    | 501 136 | 5022    |
| 302 074 | 5228    | 401 212 | 5123    | 501 147 | 5034    |
| 302 076 | 5234    | 401 214 | 4072    | 501 158 | 5033    |
| 302 120 | 5232    | 401 214 | 4072S   | 501 161 | 6250    |
| 302 122 | 5233    | 401 222 | 5102    | 501 170 | 5020    |
| 302 124 | 4080    | 401 222 | 5102S   | 501 184 | 5000    |
| 302 146 | 5210    | 401 276 | 5100    | 501 194 | 5002    |
| 302 160 | 4053    | 401 276 | 5100S   | 501 513 | 5040    |
| 302 162 | 4068    | 401 277 | 5106    | 502 066 | 5012    |
| 302 164 | 4086    | 401 277 | 5106S   | 502 068 | 5016    |
| 302 166 | 4085    | 401 300 | 8701    | 502 070 | 5010    |
| 302 172 | 4052    | 401 501 | 5138    | 502 072 | 5019    |
| 302 174 | 4069    | 402 030 | 5103    | 502 109 | 5031    |
| 302 176 | 4070    | 402 030 | 5103S   | 502 123 | 5029    |
| 302 186 | 5243    | 402 050 | 5110    | 502 125 | 5028    |
| 302 188 | 5244    | 402 050 | 5110S   | 502 134 | 5003    |
| 302 190 | 5247    | 402 063 | 5132    | 502 135 | 5025    |
| 302 192 | 5245    | 402 080 | 5115    | 502 135 | 5027    |
| 302 196 | 5246    | 402 080 | 5116    | 502 138 | 5023    |
| 302 197 | 5224    | 402 081 | 5134    | 502 148 | 5024    |
| 302 234 | 5213    | 402 116 | 5107    | 502 158 | 5014    |
| 302 240 | 4067    | 402 116 | 5107S   | 502 163 | 6251    |
| 302 248 | 5240    | 402 116 | 5113S   | 502 178 | 5007    |



## VERGLEICHSDATENLISTE

### CROSS REFERENCE GUIDE / LISTE DES ÉQUIVALENCES

| OPTIMAL | RUVILLE | OPTIMAL | RUVILLE | OPTIMAL | RUVILLE |
|---------|---------|---------|---------|---------|---------|
| 502 252 | 5032    | 602 361 | 5930    | 682 327 | 4095    |
| 600 308 | 6613    | 602 367 | 5936    | 682 329 | 4096    |
| 600 334 | 6614    | 602 369 | 5935    | 682 420 | 4043    |
| 600 410 | 5600    | 602 386 | 6630    | 682 422 | 4044    |
| 601 253 | 6603    | 602 388 | 5922    | 682 437 | 4037    |
| 601 306 | 5914    | 602 390 | 5913    | 682 490 | 4084    |
| 601 323 | 6628    | 602 392 | 6609    | 682 492 | 4083    |
| 601 336 | 5916    | 602 406 | 5903    | 682 508 | 4078    |
| 601 336 | 6611    | 602 412 | 5902    | 682 510 | 4079    |
| 601 348 | 5924    | 602 414 | 5912    | 682 593 | 4016    |
| 601 384 | 5908    | 602 416 | 6603    | 682 642 | 4003    |
| 601 396 | 5910    | 602 418 | 6601    | 682 925 | 4014    |
| 601 434 | 6608    | 602 430 | 5920    | 700 245 | 5572    |
| 601 440 | 6600    | 602 512 | 6618    | 700 310 | 5516    |
| 601 446 | 5604    | 602 539 | 5921    | 700 310 | 5534    |
| 601 495 | 5907    | 602 541 | 5904    | 700 310 | 5557    |
| 601 502 | 6610    | 602 584 | 4019    | 701 247 | 5574    |
| 601 521 | 6200    | 602 645 | 5940    | 701 302 | 5529    |
| 601 580 | 4018    | 602 669 | 6607    | 701 302 | 5531    |
| 601 582 | 6617    | 602 681 | 5949    | 701 302 | 5532    |
| 601 654 | 5905    | 602 815 | 5906    | 701 302 | 5562    |
| 601 675 | 5947    | 602 815 | 6606    | 701 307 | 5538    |
| 601 828 | 6602    | 602 821 | 5909    | 701 307 | 5544    |
| 601 916 | 5917    | 602 833 | 5206    | 701 307 | 5559    |
| 601 953 | 5944    | 602 858 | 5938    | 701 319 | 5512    |
| 602 249 | 5939    | 602 859 | 5911    | 701 326 | 5511    |
| 602 251 | 6632    | 602 865 | 6619    | 701 332 | 5508    |
| 602 314 | 5929    | 602 926 | 6615    | 701 346 | 5516    |
| 602 314 | 6622    | 602 927 | 5941    | 701 374 | 5510    |
| 602 320 | 5919    | 602 937 | 5926    | 701 404 | 5509    |
| 602 322 | 6615    | 602 955 | 6631    | 701 424 | 5514    |
| 602 337 | 5937    | 602 956 | 5942    | 701 432 | 5521    |
| 602 337 | 6624    | 681 259 | 5815    | 701 726 | 4023    |
| 602 338 | 5923    | 681 261 | 5945    | 701 728 | 4057    |
| 602 339 | 5943    | 681 303 | 5931    | 701 826 | 5501    |
| 602 339 | 6623    | 681 325 | 4094    | 701 852 | 5502    |
| 602 340 | 5915    | 681 375 | 4017    | 701 852 | 5552    |
| 602 341 | 6625    | 681 471 | 4038    | 701 860 | 4006    |
| 602 343 | 5934    | 681 504 | 4042    | 701 860 | 5564    |
| 602 344 | 5925    | 681 506 | 4077    | 701 914 | 5561    |
| 602 344 | 5926    | 681 640 | 4002    | 701 975 | 5507    |
| 602 345 | 5933    | 681 923 | 4013    | 701 977 | 5575    |
| 602 345 | 6629    | 681 924 | 4015    | 701 978 | 5576    |
| 602 347 | 6626    | 682 263 | 5946    | 702 309 | 5539    |
| 602 349 | 6627    | 682 305 | 5838    | 702 311 | 5541    |
| 602 356 | 6621    | 682 305 | 5932    | 702 312 | 5513    |
| 602 358 | 6605    | 682 305 | 5999    | 702 312 | 5535    |

## VERGLEICHNUMMERNLISTE

### CROSS REFERENCE GUIDE / LISTE DES ÉQUIVALENCES

| OPTIMAL | RUVILLE | OPTIMAL | RUVILLE | OPTIMAL | RUVILLE |
|---------|---------|---------|---------|---------|---------|
| 702 312 | 5563    | 800 366 | 5828    | 802 265 | 5856    |
| 702 313 | 5542    | 800 398 | 5832    | 802 271 | 5852    |
| 702 316 | 5517    | 800 398 | 5836    | 802 315 | 5839    |
| 702 316 | 5536    | 800 400 | 5818    | 802 318 | 5810    |
| 702 321 | 5556    | 800 408 | 5807    | 802 324 | 5817    |
| 702 328 | 5506    | 801 238 | 6000    | 802 330 | 5822    |
| 702 350 | 5522    | 801 267 | 5855    | 802 330 | 5823    |
| 702 351 | 5550    | 801 269 | 5840    | 802 331 | 7606    |
| 702 352 | 5519    | 801 342 | 5813    | 802 335 | 6022    |
| 702 353 | 5549    | 801 354 | 8260    | 802 368 | 5820    |
| 702 355 | 5547    | 801 360 | 5824    | 802 370 | 5819    |
| 702 357 | 5546    | 801 362 | 5835    | 802 378 | 5821    |
| 702 359 | 5551    | 801 364 | 5834    | 802 394 | 5814    |
| 702 363 | 5545    | 801 372 | 7600    | 802 444 | 5829    |
| 702 365 | 5548    | 801 376 | 5831    | 802 454 | 7200    |
| 702 380 | 5515    | 801 382 | 5830    | 802 464 | 5804    |
| 702 380 | 5525    | 801 402 | 5801    | 802 464 | 5804S   |
| 702 380 | 5539    | 801 428 | 6018    | 802 480 | 5811    |
| 702 426 | 5527    | 801 438 | 6006    | 802 485 | 6023    |
| 702 426 | 5558    | 801 442 | 7203    | 802 488 | 6009    |
| 702 436 | 4024    | 801 450 | 5825    | 802 526 | 5833    |
| 702 448 | 4047    | 801 478 | 6008    | 802 528 | 6021    |
| 702 452 | 5518    | 801 500 | 6015    | 802 540 | 6014    |
| 702 452 | 5540    | 801 500 | 6020    | 802 542 | 6013    |
| 702 456 | 4025    | 801 538 | 5802    | 802 556 | 6007    |
| 702 462 | 4046    | 801 543 | 5449    | 802 558 | 6012    |
| 702 494 | 5526    | 801 554 | 6019    | 802 560 | 6016    |
| 702 514 | 5524    | 801 574 | 5800    | 802 562 | 6017    |
| 702 537 | 5553    | 801 588 | 6001    | 802 590 | 7202    |
| 702 550 | 5523    | 801 618 | 7800    | 802 601 | 5848    |
| 702 550 | 5543    | 801 644 | 4059    | 802 605 | 5847    |
| 702 552 | 5528    | 801 656 | 7201    | 802 620 | 7600    |
| 702 586 | 4081    | 801 694 | 7802    | 802 646 | 6003    |
| 702 692 | 4056    | 801 698 | 5808    | 802 652 | 6002    |
| 702 765 | 5537    | 801 730 | 5837    | 802 658 | 7204    |
| 702 817 | 5503    | 801 746 | 4029    | 802 660 | 4033    |
| 702 846 | 4001    | 801 750 | 4058    | 802 662 | 4032    |
| 702 846 | 5565    | 801 836 | 5844    | 802 720 | 7801    |
| 702 850 | 5560    | 801 838 | 5843    | 802 732 | 7803    |
| 702 866 | 5554    | 801 880 | 5841    | 802 740 | 4066    |
| 702 915 | 5598    | 801 922 | 5803    | 802 748 | 4065    |
| 702 957 | 5567    | 801 950 | 5842    | 802 839 | 5846    |
| 702 958 | 5566    | 801 961 | 6030    | 802 870 | 6026    |
| 702 959 | 5568    | 801 970 | 6025    | 802 886 | 7602    |
| 702 960 | 5555    | 801 972 | 5845    | 802 888 | 6027    |
| 702 982 | 5577    | 801 974 | 5854    | 802 954 | 5816    |
| 800 304 | 5812    | 802 233 | 7607    | 802 980 | 5853    |

## VERGLEICHSDATENLISTE

### CROSS REFERENCE GUIDE / LISTE DES ÉQUIVALENCES

| OPTIMAL | RUVILLE | OPTIMAL | RUVILLE | OPTIMAL | RUVILLE |
|---------|---------|---------|---------|---------|---------|
| 880 419 | 8001    | 891 524 | 6408    | 902 771 | 7915    |
| 880 421 | 8002    | 891 536 | 6513    | 902 855 | 7917    |
| 880 493 | 8304    | 891 544 | 6518    | 911 375 | 7408    |
| 880 525 | 6105    | 891 546 | 6410    | 911 375 | 7410    |
| 880 812 | 8000    | 891 591 | 6531    | 911 375 | 7411    |
| 880 912 | 6103    | 891 628 | 6517    | 911 377 | 7425    |
| 881 237 | 6126    | 891 630 | 6415    | 911 383 | 7434    |
| 881 489 | 8303    | 891 706 | 6405    | 911 385 | 7428    |
| 881 507 | 6100    | 891 731 | 6525    | 911 385 | 7436    |
| 881 534 | 6108    | 891 822 | 6300    | 911 387 | 7429    |
| 881 564 | 8300    | 891 869 | 6526    | 911 399 | 7433    |
| 881 592 | 6109    | 891 878 | 6527    | 911 513 | 7403    |
| 881 594 | 6110    | 891 887 | 6418    | 911 513 | 7404    |
| 881 609 | 6112    | 891 928 | 6529    | 911 600 | 7413    |
| 881 622 | 6106    | 892 458 | 6505    | 911 621 | 7405    |
| 881 704 | 7412    | 892 460 | 6503    | 911 623 | 7421    |
| 881 725 | 6123    | 892 468 | 6509    | 911 625 | 7405    |
| 882 167 | 6128    | 892 470 | 6510    | 911 647 | 7440    |
| 882 235 | 6127    | 892 472 | 6515    | 911 777 | 7430    |
| 882 463 | 6101    | 892 474 | 6508    | 911 782 | 7406    |
| 882 463 | 6115    | 892 476 | 6411    | 912 401 | 7439    |
| 882 483 | 6119    | 892 498 | 6414    | 912 403 | 7432    |
| 882 487 | 6122    | 892 668 | 6412    | 912 423 | 7424    |
| 882 491 | 8302    | 892 670 | 6409    | 912 471 | 7420    |
| 882 598 | 6101    | 892 733 | 6519    | 912 473 | 7417    |
| 882 607 | 6116    | 892 735 | 6520    | 912 505 | 7402    |
| 882 611 | 6113    | 892 802 | 6506    | 912 515 | 7409    |
| 882 613 | 6114    | 892 804 | 6302    | 912 527 | 7414    |
| 882 624 | 6120    | 892 806 | 6407    | 912 530 | 7415    |
| 882 626 | 6121    | 892 830 | 6406    | 912 530 | 7419    |
| 882 643 | 6111    | 892 843 | 6522    | 912 530 | 7423    |
| 882 664 | 6107    | 892 872 | 6528    | 912 530 | 7435    |
| 882 666 | 8301    | 892 929 | 6530    | 912 532 | 7416    |
| 882 727 | 6118    | 901 425 | 7907    | 912 545 | 7431    |
| 882 729 | 6117    | 901 425 | 7912    | 912 775 | 7426    |
| 882 819 | 6102    | 901 427 | 7906    | 912 775 | 7437    |
| 891 333 | 6512    | 901 429 | 7908    | 912 803 | 7438    |
| 891 466 | 6514    | 901 429 | 7913    | 920 752 | 7300    |
| 891 469 | 6523    | 901 445 | 7918    | 922 439 | 8400    |
| 891 477 | 6524    | 901 461 | 7900    | 922 441 | 8401    |
| 891 482 | 6521    | 901 461 | 7902    | 922 781 | 8402    |
| 891 484 | 6511    | 901 549 | 7911    | 922 783 | 8403    |
| 891 486 | 6516    | 902 443 | 7914    | 922 825 | 8930    |
| 891 496 | 6413    | 902 457 | 7903    | 922 882 | 8404    |
| 891 509 | 6403    | 902 457 | 7910    | 922 921 | 8411    |
| 891 520 | 6507    | 902 459 | 7901    | 922 979 | 8410    |
| 891 522 | 6504    | 902 547 | 7916    | 940 371 | 7032    |

## VERGLEICHNUMMERNLISTE

### CROSS REFERENCE GUIDE / LISTE DES ÉQUIVALENCES

| OPTIMAL | RUVILLE | OPTIMAL | RUVILLE | OPTIMAL | RUVILLE |
|---------|---------|---------|---------|---------|---------|
| 940 632 | 7014    | 951 962 | 8405    | 962 481 | 6838    |
| 941 497 | 7002    | 952 405 | 7323    | 962 517 | 6805    |
| 941 511 | 4030    | 952 415 | 7317    | 962 548 | 6824    |
| 941 565 | 4082    | 952 417 | 7318    | 962 548 | 6837    |
| 941 602 | 7015    | 952 551 | 7324    | 962 682 | 6815    |
| 941 617 | 7019    | 952 593 | 7305    | 962 684 | 6804    |
| 941 634 | 7004    | 952 608 | 7316    | 962 686 | 4041    |
| 941 636 | 7009    | 952 661 | 7307    | 962 686 | 4055    |
| 941 700 | 7022    | 952 676 | 7313    | 962 703 | 6827    |
| 941 734 | 7007    | 952 678 | 7312    | 962 705 | 6833    |
| 941 784 | 7027    | 952 679 | 7311    | 962 712 | 6829    |
| 941 786 | 7003    | 952 710 | 7309    | 962 714 | 6834    |
| 941 840 | 7022    | 952 758 | 4035    | 962 716 | 6820    |
| 941 842 | 7025    | 952 769 | 7319    | 962 718 | 6819    |
| 941 862 | 7031    | 952 832 | 7301    | 962 755 | 6843    |
| 941 874 | 7026    | 952 935 | 7321    | 962 757 | 6844    |
| 941 951 | 7033    | 952 936 | 7307    | 962 760 | 6817    |
| 942 177 | 7035    | 960 578 | 6818    | 962 767 | 6849    |
| 942 273 | 7037    | 960 578 | 6823    | 962 776 | 6810    |
| 942 381 | 7030    | 960 638 | 6826    | 962 810 | 6856    |
| 942 501 | 7006    | 960 638 | 6835    | 962 841 | 6853    |
| 942 566 | 7008    | 960 702 | 6821    | 962 899 | 6841    |
| 942 568 | 7011    | 961 411 | 6854    | 962 905 | 6852    |
| 942 569 | 7023    | 961 479 | 6840    | 962 913 | 6851    |
| 942 570 | 7010    | 961 503 | 6809    | 962 949 | 6836    |
| 942 619 | 7021    | 961 576 | 6816    | 971 285 | 8111    |
| 942 672 | 7016    | 961 610 | 6822    | 971 391 | 5314    |
| 942 674 | 7005    | 961 648 | 6830    | 971 391 | 8450    |
| 942 736 | 7028    | 961 677 | 4090    | 971 393 | 5315    |
| 942 738 | 7020    | 961 680 | 6811    | 971 451 | 7702    |
| 942 754 | 4031    | 961 701 | 6857    | 971 455 | 7709    |
| 942 768 | 7013    | 961 724 | 4092    | 971 567 | 7714    |
| 942 770 | 7012    | 961 751 | 6846    | 971 575 | 7706    |
| 942 773 | 7024    | 961 753 | 6839    | 971 612 | 7712    |
| 942 788 | 7001    | 961 753 | 6842    | 971 615 | 8101    |
| 942 818 | 7017    | 961 759 | 6845    | 971 627 | 8100    |
| 942 820 | 7018    | 961 765 | 6825    | 971 631 | 8104    |
| 951 282 | 8406    | 961 765 | 6848    | 971 635 | 8105    |
| 951 409 | 7322    | 961 792 | 6813    | 971 641 | 8106    |
| 951 449 | 7310    | 961 796 | 6802    | 971 707 | 8109    |
| 951 519 | 7303    | 961 808 | 4039    | 971 711 | 7706    |
| 951 604 | 7314    | 961 808 | 4054    | 971 723 | 7705    |
| 951 606 | 7308    | 961 883 | 6812    | 971 917 | 8453    |
| 951 606 | 7315    | 961 903 | 6847    | 972 389 | 5307    |
| 951 708 | 4034    | 961 904 | 6850    | 972 453 | 7708    |
| 951 722 | 7306    | 962 413 | 6855    | 972 453 | 7710    |
| 951 756 | 7302    | 962 435 | 4091    | 972 465 | 8103    |

## VERGLEICHNUMMERNLISTE

### CROSS REFERENCE GUIDE / LISTE DES ÉQUIVALENCES

| OPTIMAL | RUVILLE | OPTIMAL        | RUVILLE    | OPTIMAL | SKF       |
|---------|---------|----------------|------------|---------|-----------|
| 972 571 | 7711    | 982 650        | 6903       | 101 064 | VKBA 802  |
| 972 573 | 7701    | 982 685        | 4089       | 101 102 | VKBA 911  |
| 972 633 | 8108    | 982 737        | 6928       | 101 108 | VKBA 912  |
| 972 637 | 8107    | 982 749        | 6908       | 101 110 | VKBA 836  |
| 972 639 | 8102    | 982 762        | 6942       | 101 111 | VKBA 3427 |
| 972 688 | 7713    | 982 764        | 6904       | 101 113 | VKBA 3455 |
| 972 699 | 7707    | 982 766        | 6910       | 101 128 | VKBA 3406 |
| 972 709 | 8110    | 982 774        | 6943       | 101 145 | VKBA 519  |
| 972 717 | 7703    | 982 778        | 6909       | 101 147 | VKBA 576  |
| 972 719 | 7704    | 982 780        | 6914       | 101 209 | VKBA 3406 |
| 972 721 | 7704    | 982 811        | 6948       | 101 250 | VKBA 1400 |
| 972 918 | 8452    | 982 813        | 6949       | 101 264 | VKBA 954  |
| 980 614 | 6921    | 982 816        | 6905       | 101 270 | VKBA 956  |
| 981 407 | 6926    | 982 857        | 6900       | 102 008 | VKBA 542  |
| 981 447 | 6917    | 982 857        | 6939       | 102 011 | VKBA 3489 |
| 981 475 | 6936    | 982 857        | 6940       | 102 019 | VKBA 3644 |
| 981 499 | 6946    | 982 884        | 4000       | 102 041 | VKBA 3535 |
| 981 533 | 6947    | 982 939        | 6930       | 102 054 | VKBA 800  |
| 981 535 | 6004    | 991 898        | 8601       | 102 055 | VKBA 3519 |
| 981 572 | 6908    | 991 902        | 7325       | 102 060 | VKBA 801  |
| 981 616 | 6950    | 991 946        | 8602       | 102 069 | VKBA 3549 |
| 981 683 | 6923    | 991 998        | 8602       | 102 071 | VKBA 3606 |
| 981 690 | 6916    | 992 894        | 7326       | 102 075 | VKBA 3548 |
| 981 742 | 6907    | 992 943        | 8600       | 102 077 | VKBA 3567 |
| 981 743 | 6931    |                |            | 102 079 | VKBA 3570 |
| 981 744 | 6911    |                |            | 102 094 | VKBA 910  |
| 981 744 | 6919    |                |            | 102 097 | VKBA 3605 |
| 981 745 | 6932    |                |            | 102 115 | VKBA 3456 |
| 981 747 | 6914    |                |            | 102 150 | VKBA 965  |
| 981 763 | 6941    |                |            | 102 152 | VKBA 1477 |
| 981 790 | 6901    |                |            | 102 154 | VKBA 1496 |
| 981 814 | 6902    |                |            | 102 156 | VKBA 1497 |
| 981 849 | 6922    |                |            | 102 213 | VKBA 3656 |
| 981 851 | 6924    |                |            | 102 266 | VKBA 592  |
| 981 856 | 6938    |                |            | 102 268 | VKBA 955  |
| 981 868 | 6937    |                |            | 131 129 | VKBA 3449 |
| 981 938 | 6929    |                |            | 132 131 | VKBA 3450 |
| 982 195 | 6951    |                |            | 190 256 | VKBA 1909 |
| 982 373 | 6912    |                |            | 191 258 | VKBA 1951 |
| 982 379 | 6920    |                |            | 191 272 | VKBA 826  |
| 982 379 | 6930    |                |            | 192 274 | VKBA 827  |
| 982 431 | 6934    |                |            | 200 012 | VKBA 944  |
| 982 431 | 6935    |                |            | 200 020 | VKBA 526  |
| 982 437 | 6912    |                |            | 201 031 | VKBA 3512 |
| 982 561 | 6918    |                |            | 201 032 | VKBA 736  |
| 982 561 | 6925    |                |            | 201 033 | VKBA 3510 |
| 982 581 | 6944    |                |            | 201 035 | VKBA 3511 |
|         |         |                |            |         |           |
|         |         | <b>OPTIMAL</b> | <b>SKF</b> |         |           |
|         |         | 100 002        | VKBA 529   |         |           |
|         |         | 100 003        | VKBA 3645  |         |           |
|         |         | 100 013        | VKBA 3646  |         |           |
|         |         | 100 014        | VKBA 575   |         |           |
|         |         | 100 022        | VKBA 1358  |         |           |
|         |         | 100 036        | VKBA 613   |         |           |
|         |         | 100 053        | VKBA 3536  |         |           |
|         |         | 100 056        | VKBA 962   |         |           |
|         |         | 100 090        | VKBA 1355  |         |           |
|         |         | 100 091        | VKBA 1355  |         |           |
|         |         | 100 093        | VKBA 1355  |         |           |
|         |         | 100 098        | VKBA 1356  |         |           |
|         |         | 100 099        | VKBA 1356  |         |           |
|         |         | 100 206        | VKBA 3406  |         |           |
|         |         | 101 010        | VKBA 593   |         |           |
|         |         | 101 016        | VKBA 906   |         |           |
|         |         | 101 017        | VKBA 3643  |         |           |
|         |         | 101 024        | VKBA 1491  |         |           |
|         |         | 101 025        | VKBA 3568  |         |           |
|         |         | 101 027        | VKBA 3569  |         |           |
|         |         | 101 029        | VKBA 3550  |         |           |
|         |         | 101 044        | VKBA 577   |         |           |

## VERGLEICHNUMMERNLISTE

### CROSS REFERENCE GUIDE / LISTE DES ÉQUIVALENCES

| OPTIMAL | SKF       | OPTIMAL | SKF       | OPTIMAL | SKF       |
|---------|-----------|---------|-----------|---------|-----------|
| 201 040 | VKBA 663  | 301 130 | VKBA 920  | 302 234 | VKBA 624  |
| 201 043 | VKBA 3513 | 301 132 | VKBA 1432 | 302 240 | VKBA 1323 |
| 201 084 | VKBA 1301 | 301 139 | VKBA 3431 | 302 248 | VKBA 1433 |
| 201 085 | VKBA 3616 | 301 141 | VKBA 3432 | 302 254 | VKBA 951  |
| 201 087 | VKBA 3571 | 301 151 | VKBA 539  | 302 255 | VKBA 3589 |
| 201 089 | VKBA 3618 | 301 180 | VKBA 1332 | 302 257 | VKBA 3590 |
| 201 095 | VKBA 3600 | 301 180 | VKBA 1431 | 302 260 | VKBA 1455 |
| 201 210 | VKBA 3403 | 301 182 | VKBA 1480 | 302 595 | VKBA 6527 |
| 201 228 | VKBA 3410 | 301 183 | VKBA 3575 | 302 597 | VKBA 6528 |
| 201 262 | VKBA 1985 | 301 185 | VKBA 3588 | 400 051 | VKBA 3522 |
| 201 517 | VKBA 3620 | 301 198 | VKBA 1478 | 400 061 | VKBA 3518 |
| 201 621 | VKBA 3650 | 301 200 | VKBA 1479 | 400 107 | VKBA 3486 |
| 201 623 | VKBA 3651 | 301 230 | VKBA 543  | 401 028 | VKBA 596  |
| 202 021 | VKBA 3601 | 301 232 | VKBA 544  | 401 028 | VKBA 831  |
| 202 023 | VKBA 3602 | 301 244 | VKBA 916  | 401 042 | VKBA 941  |
| 202 026 | VKBA 754  | 301 246 | VKBA 917  | 401 047 | VKBA 3520 |
| 202 059 | VKBA 3514 | 301 280 | VKBA 505  | 401 048 | VKBA 756  |
| 202 065 | VKBA 1461 | 301 511 | VKBA 3625 | 401 078 | VKBA 1498 |
| 202 101 | VKBA 3617 | 301 583 | VKBA 6525 | 401 082 | VKBA 1499 |
| 202 140 | VKBA 1471 | 301 585 | VKBA 6526 | 401 083 | VKBA 3565 |
| 202 140 | VKBA 3422 | 301 667 | VKBA 3660 | 401 096 | VKBA 1339 |
| 202 142 | VKBA 1472 | 302 037 | VKBA 3517 | 401 100 | VKBA 1396 |
| 202 142 | VKBA 3409 | 302 046 | VKBA 742  | 401 104 | VKBA 1397 |
| 202 168 | VKBA 1326 | 302 057 | VKBA 3532 | 401 126 | VKBA 1337 |
| 202 202 | VKBA 992  | 302 058 | VKBA 1333 | 401 137 | VKBA 1451 |
| 202 204 | VKBA 994  | 302 058 | VKBA 3666 | 401 137 | VKBA 3434 |
| 202 218 | VKBA 3411 | 302 067 | VKBA 3485 | 401 212 | VKBA 3417 |
| 202 218 | VKBA 3484 | 302 074 | VKBA 897  | 401 214 | VKBA 3404 |
| 202 218 | VKBA 3534 | 302 076 | VKBA 898  | 401 222 | VKBA 517  |
| 202 218 | VKBA 3555 | 302 120 | VKBA 918  | 401 276 | VKBA 516  |
| 202 224 | VKBA 3572 | 302 122 | VKBA 919  | 402 030 | VKBA 614  |
| 202 226 | VKBA 697  | 302 124 | VKBA 959  | 402 050 | VKBA 1470 |
| 202 236 | VKBA 990  | 302 146 | VKBA 861  | 402 063 | VKBA 3521 |
| 202 252 | VKBA 787  | 302 160 | VKBA 921  | 402 080 | VKBA 1347 |
| 202 519 | VKBA 3624 | 302 162 | VKBA 923  | 402 081 | VKBA 3566 |
| 202 625 | VKBA 3652 | 302 164 | VKBA 1466 | 402 116 | VKBA 757  |
| 202 627 | VKBA 3653 | 302 166 | VKBA 1467 | 402 117 | VKBA 3435 |
| 300 004 | VKBA 528  | 302 172 | VKBA 922  | 402 119 | VKBA 3475 |
| 300 052 | VKBA 504  | 302 174 | VKBA 957  | 402 143 | VKBA 3426 |
| 300 062 | VKBA 523  | 302 176 | VKBA 958  | 402 216 | VKBA 3405 |
| 301 006 | VKBA 687  | 302 186 | VKBA 1481 | 402 242 | VKBA 3400 |
| 301 018 | VKBA 686  | 302 188 | VKBA 1482 | 402 243 | VKBA 3628 |
| 301 034 | VKBA 740  | 302 190 | VKBA 1483 | 402 467 | VKBA 3685 |
| 301 038 | VKBA 741  | 302 192 | VKBA 1484 | 501 049 | VKBA 3529 |
| 301 039 | VKBA 3530 | 302 196 | VKBA 1485 | 501 088 | VKBA 890  |
| 301 045 | VKBA 3531 | 302 197 | VKBA 3576 | 501 088 | VKBA 3665 |
| 301 118 | VKBA 1465 | 302 208 | VKBA 924  | 501 092 | VKBA 889  |

## VERGLEICHNUMMERNLISTE

### CROSS REFERENCE GUIDE / LISTE DES ÉQUIVALENCES

| OPTIMAL | SKF       | OPTIMAL | SKF       | OPTIMAL | SKF       |
|---------|-----------|---------|-----------|---------|-----------|
| 501 112 | VKBA 938  | 601 440 | VKBA 678  | 602 541 | VKBA 547  |
| 501 112 | VKBA 3665 | 601 446 | VKBA 738  | 602 584 | VKBA 805  |
| 501 114 | VKBA 891  | 601 495 | VKBA 618  | 602 645 | VKBA 3546 |
| 501 114 | VKBA 939  | 601 502 | VKBA 720  | 602 669 | VKBA 3658 |
| 501 114 | VKBA 3621 | 601 521 | VKBA 979  | 602 681 | VKBA 3693 |
| 501 121 | VKBA 3444 | 601 580 | VKBA 804  | 602 815 | VKBA 541  |
| 501 133 | VKBA 3451 | 601 582 | VKBA 1329 | 602 821 | VKBA 617  |
| 501 136 | VKBA 1458 | 601 654 | VKBA 611  | 602 833 | VKBA 769  |
| 501 136 | VKBA 3667 | 601 675 | VKBA 3683 | 602 835 | VKBA 3697 |
| 501 147 | VKBA 3671 | 601 828 | VKBA 676  | 602 858 | VKBA 3556 |
| 501 158 | VKBA 3574 | 601 834 | VKBA 3684 | 602 859 | VKBA 546  |
| 501 161 | VKBA 3674 | 601 916 | VKBA 3554 | 602 865 | VKBA 679  |
| 501 170 | VKBA 1338 | 601 953 | VKBA 3584 | 602 881 | VKBA 880  |
| 501 170 | VKBA 1456 | 602 249 | VKBA 3564 | 602 926 | VKBA 3557 |
| 501 184 | VKBA 515  | 602 251 | VKBA 3659 | 602 927 | VKBA 3560 |
| 501 194 | VKBA 531  | 602 314 | VKBA 1475 | 602 955 | VKBA 3594 |
| 501 513 | VKBA 3681 | 602 320 | VKBA 961  | 602 956 | VKBA 3585 |
| 501 653 | VKBA 3670 | 602 322 | VKBA 1328 | 681 259 | VKBA 3649 |
| 502 066 | VKBA 1318 | 602 337 | VKBA 3477 | 681 261 | VKBA 3633 |
| 502 068 | VKBA 1317 | 602 337 | VKBA 3587 | 681 303 | VKBA 3423 |
| 502 070 | VKBA 1319 | 602 338 | VKBA 1405 | 681 325 | VKBA 3428 |
| 502 072 | VKBA 1320 | 602 339 | VKBA 3478 | 681 375 | VKBA 3640 |
| 502 109 | VKBA 3499 | 602 340 | VKBA 743  | 681 471 | VKBA 3641 |
| 502 123 | VKBA 3445 | 602 341 | VKBA 3479 | 681 504 | VKBA 844  |
| 502 125 | VKBA 3446 | 602 343 | VKBA 3476 | 681 506 | VKBA 1444 |
| 502 134 | VKBA 583  | 602 344 | VKBA 1490 | 681 640 | VKBA 813  |
| 502 135 | VKBA 3447 | 602 345 | VKBA 3482 | 681 907 | VKBA 5240 |
| 502 135 | VKBA 3452 | 602 345 | VKBA 3592 | 681 909 | VKBA 3508 |
| 502 135 | VKBA 3668 | 602 347 | VKBA 3480 | 681 910 | VKBA 3509 |
| 502 138 | VKBA 1459 | 602 349 | VKBA 3481 | 681 919 | VKBA 806  |
| 502 148 | VKBA 1460 | 602 356 | VKBA 1411 | 681 923 | VKBA 3551 |
| 502 158 | VKBA 862  | 602 358 | VKBA 665  | 681 924 | VKBA 3553 |
| 502 163 | VKBA 3673 | 602 361 | VKBA 3465 | 682 263 | VKBA 3635 |
| 502 178 | VKBA 623  | 602 367 | VKBA 3454 | 682 305 | VKBA 3424 |
| 502 252 | VKBA 3675 | 602 369 | VKBA 3453 | 682 327 | VKBA 3429 |
| 600 308 | VKBA 915  | 602 386 | VKBA 3545 | 682 329 | VKBA 3430 |
| 600 308 | VKBA 3593 | 602 388 | VKBA 1331 | 682 420 | VKBA 845  |
| 600 334 | VKBA 1327 | 602 390 | VKBA 729  | 682 422 | VKBA 846  |
| 600 410 | VKBA 551  | 602 392 | VKBA 666  | 682 437 | VKBA 3642 |
| 601 253 | VKBA 3657 | 602 406 | VKBA 622  | 682 490 | VKBA 1463 |
| 601 306 | VKBA 882  | 602 412 | VKBA 602  | 682 492 | VKBA 1462 |
| 601 323 | VKBA 3490 | 602 414 | VKBA 728  | 682 508 | VKBA 1445 |
| 601 336 | VKBA 1336 | 602 416 | VKBA 893  | 682 510 | VKBA 1446 |
| 601 348 | VKBA 1412 | 602 418 | VKBA 892  | 682 593 | VKBA 5274 |
| 601 384 | VKBA 540  | 602 430 | VKBA 1312 | 682 642 | VKBA 814  |
| 601 396 | VKBA 612  | 602 512 | VKBA 1330 | 682 892 | VKBA 5248 |
| 601 434 | VKBA 871  | 602 539 | VKBA 1311 | 682 911 | VKBA 1474 |

## VERGLEICHNUMMERNLISTE

### CROSS REFERENCE GUIDE / LISTE DES ÉQUIVALENCES

| OPTIMAL | SKF       | OPTIMAL | SKF       | OPTIMAL | SKF       |
|---------|-----------|---------|-----------|---------|-----------|
| 682 920 | VKBA 843  | 702 380 | VKBA 967  | 801 478 | VKBA 792  |
| 682 921 | VKBA 935  | 702 380 | VKBA 968  | 801 500 | VKBA 1488 |
| 682 925 | VKBA 3552 | 702 426 | VKBA 976  | 801 538 | VKBA 927  |
| 700 245 | VKBA 3615 | 702 436 | VKBA 828  | 801 543 | VKBA 3441 |
| 700 310 | VKBA 1308 | 702 448 | VKBA 848  | 801 554 | VKBA 718  |
| 700 310 | VKBA 3596 | 702 452 | VKBA 968  | 801 574 | VKBA 926  |
| 701 247 | VKBA 3648 | 702 456 | VKBA 830  | 801 588 | VKBA 667  |
| 701 302 | VKBA 868  | 702 462 | VKBA 849  | 801 618 | VKBA 708  |
| 701 302 | VKBA 1413 | 702 494 | VKBA 1494 | 801 644 | VKBA 1386 |
| 701 302 | VKBA 3496 | 702 514 | VKBA 1406 | 801 656 | VKBA 1324 |
| 701 307 | VKBA 3437 | 702 537 | VKBA 3483 | 801 694 | VKBA 3494 |
| 701 307 | VKBA 3495 | 702 550 | VKBA 972  | 801 698 | VKBA 929  |
| 701 319 | VKBA 3496 | 702 552 | VKBA 974  | 801 730 | VKBA 3416 |
| 701 326 | VKBA 966  | 702 586 | VKBA 3407 | 801 746 | VKBA 600  |
| 701 332 | VKBA 723  | 702 692 | VKBA 977  | 801 750 | VKBA 1385 |
| 701 346 | VKBA 3408 | 702 817 | VKBA 548  | 801 836 | VKBA 3538 |
| 701 374 | VKBA 636  | 702 846 | VKBA 3501 | 801 838 | VKBA 3539 |
| 701 404 | VKBA 909  | 702 846 | VKBA 3614 | 801 880 | VKBA 3528 |
| 701 424 | VKBA 908  | 702 850 | VKBA 3506 | 801 922 | VKBA 928  |
| 701 432 | VKBA 638  | 702 866 | VKBA 3497 | 801 950 | VKBA 3577 |
| 701 726 | VKBA 829  | 702 957 | VKBA 3561 | 801 961 | VKBA 3580 |
| 701 728 | VKBA 847  | 702 958 | VKBA 3542 | 801 970 | VKBA 3502 |
| 701 826 | VKBA 639  | 702 959 | VKBA 3559 | 801 972 | VKBA 3578 |
| 701 852 | VKBA 3504 | 702 960 | VKBA 3558 | 801 974 | VKBA 3598 |
| 701 860 | VKBA 3500 | 702 982 | VKBA 3639 | 802 233 | VKBA 3636 |
| 701 860 | VKBA 3613 | 702 983 | VKBA 3676 | 802 271 | VKBA 3582 |
| 701 914 | VKBA 3492 | 800 304 | VKBA 685  | 802 315 | VKBA 3442 |
| 701 975 | VKBA 3608 | 800 366 | VKBA 1414 | 802 318 | VKBA 625  |
| 701 977 | VKBA 3637 | 800 398 | VKBA 1439 | 802 324 | VKBA 940  |
| 701 978 | VKBA 3638 | 800 400 | VKBA 1302 | 802 330 | VKBA 1440 |
| 702 309 | VKBA 3438 | 800 400 | VKBA 1403 | 802 331 | VKBA 3433 |
| 702 311 | VKBA 3439 | 800 408 | VKBA 559  | 802 335 | VKBA 3436 |
| 702 312 | VKBA 869  | 801 238 | VKBA 594  | 802 368 | VKBA 1303 |
| 702 312 | VKBA 3525 | 801 267 | VKBA 3599 | 802 370 | VKBA 1304 |
| 702 313 | VKBA 3440 | 801 342 | VKBA 734  | 802 378 | VKBA 1441 |
| 702 316 | VKBA 975  | 801 354 | VKBA 1410 | 802 394 | VKBA 310  |
| 702 321 | VKBA 3491 | 801 360 | VKBA 1402 | 802 444 | VKBA 1443 |
| 702 328 | VKBA 652  | 801 362 | VKBA 3414 | 802 454 | VKBA 973  |
| 702 350 | VKBA 654  | 801 364 | VKBA 3413 | 802 464 | VKBA 562  |
| 702 351 | VKBA 3466 | 801 372 | VKBA 895  | 802 480 | VKBA 607  |
| 702 352 | VKBA 969  | 801 376 | VKBA 1438 | 802 485 | VKBA 3459 |
| 702 353 | VKBA 3467 | 801 382 | VKBA 1442 | 802 488 | VKBA 885  |
| 702 355 | VKBA 3468 | 801 402 | VKBA 925  | 802 526 | VKBA 1476 |
| 702 357 | VKBA 3469 | 801 428 | VKBA 1447 | 802 528 | VKBA 1486 |
| 702 359 | VKBA 3464 | 801 438 | VKBA 1487 | 802 540 | VKBA 963  |
| 702 363 | VKBA 3470 | 801 442 | VKBA 1306 | 802 542 | VKBA 964  |
| 702 365 | VKBA 3471 | 801 450 | VKBA 1401 | 802 556 | VKBA 726  |



## VERGLEICHNUMMERNLISTE

### CROSS REFERENCE GUIDE / LISTE DES ÉQUIVALENCES

| OPTIMAL | SKF       | OPTIMAL | SKF       | OPTIMAL | SKF       |
|---------|-----------|---------|-----------|---------|-----------|
| 802 558 | VKBA 725  | 882 487 | VKBA 3457 | 892 458 | VKBA 733  |
| 802 560 | VKBA 1449 | 882 491 | VKBA 3473 | 892 460 | VKBA 571  |
| 802 562 | VKBA 1450 | 882 531 | VKBA 788  | 892 468 | VKBA 1314 |
| 802 590 | VKBA 1325 | 882 596 | VKBA 750  | 892 470 | VKBA 1436 |
| 802 620 | VKBA 896  | 882 598 | VKBA 730  | 892 472 | VKBA 1437 |
| 802 646 | VKBA 586  | 882 607 | VKBA 3498 | 892 474 | VKBA 933  |
| 802 652 | VKBA 532  | 882 611 | VKBA 1468 | 892 476 | VKBA 914  |
| 802 658 | VKBA 1307 | 882 613 | VKBA 1469 | 892 498 | VKBA 1409 |
| 802 660 | VKBA 598  | 882 624 | VKBA 1493 | 892 587 | VKBA 3627 |
| 802 662 | VKBA 597  | 882 626 | VKBA 1492 | 892 589 | VKBA 3631 |
| 802 720 | VKBA 709  | 882 643 | VKBA 1453 | 892 668 | VKBA 1309 |
| 802 732 | VKBA 1430 | 882 664 | VKBA 937  | 892 670 | VKBA 943  |
| 802 740 | VKBA 1394 | 882 666 | VKBA 866  | 892 733 | VKBA 3402 |
| 802 748 | VKBA 1393 | 882 727 | VKBA 3462 | 892 735 | VKBA 3418 |
| 802 826 | VKBA 3597 | 882 729 | VKBA 3463 | 892 802 | VKBA 907  |
| 802 839 | VKBA 3540 | 882 819 | VKBA 580  | 892 804 | VKBA 599  |
| 802 839 | VKBA 3597 | 882 861 | VKBA 568  | 892 806 | VKBA 746  |
| 802 870 | VKBA 3503 | 882 863 | VKBA 581  | 892 830 | VKBA 702  |
| 802 886 | VKBA 3544 | 882 875 | VKBA 759  | 892 843 | VKBA 3458 |
| 802 888 | VKBA 3541 | 882 896 | VKBA 3610 | 892 872 | VKBA 3524 |
| 802 980 | VKBA 3583 | 891 333 | VKBA 3425 | 892 929 | VKBA 3573 |
| 880 419 | VKBA 3420 | 891 466 | VKBA 1435 | 892 929 | VKBA 3632 |
| 880 421 | VKBA 3421 | 891 469 | VKBA 3488 | 901 425 | VKBA 3297 |
| 880 493 | VKBA 3474 | 891 477 | VKBA 3487 | 901 427 | VKBA 3294 |
| 880 525 | VKBA 658  | 891 477 | VKBA 3647 | 901 429 | VKBA 3293 |
| 880 812 | VKBA 838  | 891 482 | VKBA 1313 | 901 445 | VKBA 1990 |
| 880 912 | VKBA 3527 | 891 484 | VKBA 1315 | 901 461 | VKBA 1926 |
| 881 237 | VKBA 3603 | 891 486 | VKBA 1495 | 901 549 | VKBA 3322 |
| 881 489 | VKBA 3472 | 891 496 | VKBA 1408 | 901 876 | VKBA 3700 |
| 881 507 | VKBA 727  | 891 509 | VKBA 744  | 901 885 | VKBA 1974 |
| 881 523 | VKBA 852  | 891 520 | VKBA 732  | 901 890 | VKBA 1940 |
| 881 527 | VKBA 758  | 891 522 | VKBA 719  | 901 895 | VKBA 1943 |
| 881 529 | VKBA 782  | 891 524 | VKBA 942  | 901 896 | VKBA 1944 |
| 881 534 | VKBA 1407 | 891 536 | VKBA 1434 | 902 443 | VKBA 1991 |
| 881 564 | VKBA 867  | 891 544 | VKBA 3401 | 902 457 | VKBA 1929 |
| 881 592 | VKBA 749  | 891 546 | VKBA 913  | 902 459 | VKBA 1927 |
| 881 594 | VKBA 1452 | 891 591 | VKBA 3626 | 902 547 | VKBA 3329 |
| 881 609 | VKBA 1464 | 891 628 | VKBA 3415 | 902 771 | VKBA 3295 |
| 881 622 | VKBA 936  | 891 630 | VKBA 3412 | 902 855 | VKBA 3296 |
| 881 704 | VKBA 1374 | 891 706 | VKBA 745  | 902 891 | VKBA 1941 |
| 881 725 | VKBA 3461 | 891 731 | VKBA 3443 | 902 897 | VKBA 1945 |
| 881 871 | VKBA 737  | 891 822 | VKBA 502  | 902 900 | VKBA 1976 |
| 881 879 | VKBA 858  | 891 869 | VKBA 3526 | 902 901 | VKBA 1942 |
| 882 167 | VKBA 3611 | 891 878 | VKBA 3523 | 902 906 | VKBA 3382 |
| 882 235 | VKBA 3604 | 891 887 | VKBA 3543 | 902 908 | VKBA 3701 |
| 882 463 | VKBA 1454 | 891 928 | VKBA 3563 | 911 375 | VKBA 1381 |
| 882 483 | VKBA 3460 | 891 928 | VKBA 3647 | 911 377 | VKBA 3245 |

## VERGLEICHNUMMERNLISTE

### CROSS REFERENCE GUIDE / LISTE DES ÉQUIVALENCES

| OPTIMAL | SKF       | OPTIMAL | SKF       | OPTIMAL | SKF       |
|---------|-----------|---------|-----------|---------|-----------|
| 911 383 | VKBA 3246 | 922 223 | VKBA 3793 | 941 700 | VKBA 1950 |
| 911 385 | VKBA 3250 | 922 395 | VKBA 3259 | 941 734 | VKBA 899  |
| 911 387 | VKBA 3251 | 922 439 | VKBA 1993 | 941 784 | VKBA 3209 |
| 911 399 | VKBA 3302 | 922 441 | VKBA 1992 | 941 786 | VKBA 661  |
| 911 513 | VKBA 857  | 922 557 | VKBA 3285 | 941 840 | VKBA 3780 |
| 911 600 | VKBA 1377 | 922 697 | VKBA 3271 | 941 842 | VKBA 3779 |
| 911 621 | VKBA 1372 | 922 781 | VKBA 3266 | 941 862 | VKBA 3781 |
| 911 623 | VKBA 1373 | 922 783 | VKBA 3267 | 941 873 | VKBA 753  |
| 911 625 | VKBA 1380 | 922 787 | VKBA 3279 | 941 874 | VKBA 1928 |
| 911 629 | VKBA 1416 | 922 789 | VKBA 3280 | 941 941 | VKBA 3935 |
| 911 777 | VKBA 3301 | 922 797 | VKBA 1994 | 942 273 | VKBA 3932 |
| 911 782 | VKBA 1382 | 922 799 | VKBA 1995 | 942 381 | VKBA 3229 |
| 911 802 | VKBA 3951 | 922 854 | VKBA 3712 | 942 501 | VKBA 668  |
| 911 831 | VKBA 3961 | 922 882 | VKBA 3770 | 942 566 | VKBA 904  |
| 911 969 | VKBA 3348 | 922 921 | VKBA 3794 | 942 568 | VKBA 947  |
| 912 191 | VKBA 3782 | 922 979 | VKBA 3794 | 942 569 | VKBA 1949 |
| 912 193 | VKBA 3798 | 922 979 | VKBA 3795 | 942 570 | VKBA 948  |
| 912 292 | VKBA 3254 | 931 649 | VKBA 1918 | 942 619 | VKBA 1351 |
| 912 292 | VKBA 3282 | 931 663 | VKBA 1903 | 942 651 | VKBA 1919 |
| 912 293 | VKBA 3349 | 931 669 | VKBA 1910 | 942 671 | VKBA 1946 |
| 912 401 | VKBA 3303 | 931 681 | VKBA 1963 | 942 672 | VKBA 1349 |
| 912 403 | VKBA 3304 | 931 697 | VKBA 1986 | 942 674 | VKBA 717  |
| 912 423 | VKBA 3300 | 931 877 | VKBA 824  | 942 693 | VKBA 1983 |
| 912 471 | VKBA 1378 | 931 930 | VKBA 3757 | 942 695 | VKBA 1984 |
| 912 473 | VKBA 1384 | 931 931 | VKBA 3761 | 942 736 | VKBA 3210 |
| 912 505 | VKBA 671  | 931 932 | VKBA 3771 | 942 738 | VKBA 1354 |
| 912 515 | VKBA 859  | 932 665 | VKBA 1904 | 942 754 | VKBA 835  |
| 912 518 | VKBA 1989 | 932 667 | VKBA 1908 | 942 768 | VKBA 1321 |
| 912 530 | VKBA 1379 | 932 794 | VKBA 825  | 942 770 | VKBA 1322 |
| 912 532 | VKBA 1375 | 932 864 | VKBA 3784 | 942 773 | VKBA 3298 |
| 912 545 | VKBA 3328 | 932 933 | VKBA 3758 | 942 788 | VKBA 657  |
| 912 775 | VKBA 3299 | 932 934 | VKBA 3760 | 942 818 | VKBA 1352 |
| 912 803 | VKBA 3748 | 940 371 | VKBA 1948 | 942 820 | VKBA 1353 |
| 912 804 | VKBA 3952 | 940 632 | VKBA 1383 | 942 844 | VKBA 3773 |
| 912 804 | VKBA 3953 | 941 497 | VKBA 655  | 942 845 | VKBA 3772 |
| 912 992 | VKBA 3349 | 941 511 | VKBA 834  | 942 942 | VKBA 3936 |
| 920 752 | VKBA 713  | 941 563 | VKBA 1997 | 951 282 | VKBA 3906 |
| 921 215 | VKBA 3909 | 941 565 | VKBA 1998 | 951 409 | VKBA 3309 |
| 921 553 | VKBA 3277 | 941 602 | VKBA 1348 | 951 449 | VKBA 1973 |
| 921 555 | VKBA 3284 | 941 617 | VKBA 1350 | 951 519 | VKBA 905  |
| 922 179 | VKBA 3933 | 941 634 | VKBA 739  | 951 604 | VKBA 1970 |
| 922 181 | VKBA 3934 | 941 636 | VKBA 949  | 951 606 | VKBA 1366 |
| 922 187 | VKBA 3792 | 941 647 | VKBA 1917 | 951 606 | VKBA 1960 |
| 922 189 | VKBA 3270 | 941 673 | VKBA 1947 | 951 606 | VKBA 3791 |
| 922 217 | VKBA 3263 | 941 687 | VKBA 1980 | 951 657 | VKBA 1924 |
| 922 219 | VKBA 3264 | 941 689 | VKBA 1981 | 951 659 | VKBA 1925 |
| 922 221 | VKBA 3265 | 941 691 | VKBA 1982 | 951 708 | VKBA 1369 |

## VERGLEICHNUMMERNLISTE

### CROSS REFERENCE GUIDE / LISTE DES ÉQUIVALENCES

| OPTIMAL | SKF       | OPTIMAL | SKF       | OPTIMAL | SKF       |
|---------|-----------|---------|-----------|---------|-----------|
| 951 722 | VKBA 1915 | 961 796 | VKBA 680  | 971 455 | VKBA 3797 |
| 951 756 | VKBA 714  | 961 801 | VKBA 3205 | 971 567 | VKBA 1979 |
| 951 807 | VKBA 1936 | 961 808 | VKBA 840  | 971 575 | VKBA 1933 |
| 951 962 | VKBA 3907 | 961 883 | VKBA 886  | 971 612 | VKBA 3219 |
| 951 971 | VKBA 3710 | 961 900 | VKBA 3281 | 971 612 | VKBA 3922 |
| 952 405 | VKBA 3305 | 961 903 | VKBA 3316 | 971 615 | VKBA 1417 |
| 952 415 | VKBA 3326 | 961 904 | VKBA 3319 | 971 627 | VKBA 1415 |
| 952 417 | VKBA 3327 | 962 227 | VKBA 3914 | 971 631 | VKBA 1418 |
| 952 551 | VKBA 3323 | 962 413 | VKBA 3332 | 971 635 | VKBA 1421 |
| 952 577 | VKBA 1938 | 962 435 | VKBA 3206 | 971 641 | VKBA 1424 |
| 952 593 | VKBA 1371 | 962 481 | VKBA 3704 | 971 707 | VKBA 3235 |
| 952 608 | VKBA 3218 | 962 517 | VKBA 887  | 971 711 | VKBA 3714 |
| 952 661 | VKBA 1368 | 962 548 | VKBA 3225 | 971 723 | VKBA 3718 |
| 952 661 | VKBA 1956 | 962 601 | VKBA 1952 | 971 791 | VKBA 3286 |
| 952 676 | VKBA 1961 | 962 603 | VKBA 1957 | 971 795 | VKBA 3288 |
| 952 678 | VKBA 1962 | 962 605 | VKBA 1958 | 971 917 | VKBA 3901 |
| 952 679 | VKBA 1959 | 962 682 | VKBA 1310 | 971 940 | VKBA 3902 |
| 952 710 | VKBA 1367 | 962 684 | VKBA 673  | 972 389 | VKBA 3255 |
| 952 758 | VKBA 1370 | 962 686 | VKBA 841  | 972 397 | VKBA 3283 |
| 952 769 | VKBA 3325 | 962 703 | VKBA 3222 | 972 453 | VKBA 1931 |
| 952 809 | VKBA 1937 | 962 705 | VKBA 3223 | 972 465 | VKBA 1420 |
| 952 832 | VKBA 715  | 962 712 | VKBA 3202 | 972 571 | VKBA 1971 |
| 952 935 | VKBA 3774 | 962 714 | VKBA 3204 | 972 573 | VKBA 1972 |
| 952 936 | VKBA 3775 | 962 716 | VKBA 1364 | 972 633 | VKBA 1419 |
| 952 995 | VKBA 3724 | 962 718 | VKBA 1363 | 972 637 | VKBA 1422 |
| 952 995 | VKBA 3725 | 962 755 | VKBA 3312 | 972 639 | VKBA 1423 |
| 960 578 | VKBA 1362 | 962 757 | VKBA 3313 | 972 688 | VKBA 3220 |
| 960 638 | VKBA 1999 | 962 760 | VKBA 1361 | 972 699 | VKBA 1988 |
| 960 702 | VKBA 1365 | 962 762 | VKBA 1360 | 972 709 | VKBA 3236 |
| 961 229 | VKBA 3272 | 962 767 | VKBA 3318 | 972 715 | VKBA 3713 |
| 961 411 | VKBA 3331 | 962 776 | VKBA 752  | 972 717 | VKBA 3715 |
| 961 479 | VKBA 3703 | 962 779 | VKBA 3252 | 972 719 | VKBA 3716 |
| 961 503 | VKBA 684  | 962 807 | VKBA 3252 | 972 721 | VKBA 3717 |
| 961 576 | VKBA 1359 | 962 810 | VKBA 3200 | 972 793 | VKBA 3287 |
| 961 610 | VKBA 3224 | 962 841 | VKBA 3330 | 972 918 | VKBA 3796 |
| 961 648 | VKBA 3201 | 962 847 | VKBA 3207 | 980 614 | VKBA 3213 |
| 961 675 | VKBA 1954 | 962 853 | VKBA 3232 | 981 149 | VKBA 6831 |
| 961 677 | VKBA 1955 | 962 899 | VKBA 1953 | 981 199 | VKBA 3959 |
| 961 680 | VKBA 751  | 962 905 | VKBA 3321 | 981 407 | VKBA 3308 |
| 961 701 | VKBA 3221 | 962 913 | VKBA 3320 | 981 447 | VKBA 1965 |
| 961 724 | VKBA 1967 | 962 981 | VKBA 3928 | 981 475 | VKBA 3237 |
| 961 751 | VKBA 3310 | 971 391 | VKBA 3256 | 981 475 | VKBA 3945 |
| 961 751 | VKBA 3315 | 971 391 | VKBA 3786 | 981 499 | VKBA 3726 |
| 961 753 | VKBA 3311 | 971 393 | VKBA 3257 | 981 533 | VKBA 3727 |
| 961 759 | VKBA 3314 | 971 393 | VKBA 3785 | 981 535 | VKBA 513  |
| 961 765 | VKBA 3317 | 971 451 | VKBA 1978 | 981 572 | VKBA 1341 |
| 961 792 | VKBA 894  | 971 455 | VKBA 1930 | 981 579 | VKBA 1914 |

## VERGLEICHNUMMERNLISTE

### CROSS REFERENCE GUIDE / LISTE DES ÉQUIVALENCES

| OPTIMAL | SKF       | OPTIMAL | SKF       | OPTIMAL | SPIDAN   |
|---------|-----------|---------|-----------|---------|----------|
| 981 616 | VKBA 1340 | 982 884 | VKBA 3756 | 102 075 | 0.027177 |
| 981 655 | VKBA 1922 | 982 939 | VKBA 3930 | 102 094 | 0.026452 |
| 981 683 | VKBA 1964 | 982 948 | VKBA 3234 | 102 150 | 0.026682 |
| 981 690 | VKBA 1911 | 991 898 | VKBA 1643 | 102 152 | 0.026867 |
| 981 742 | VKBA 1343 | 991 902 | VKBA 3307 | 102 154 | 0.026868 |
| 981 743 | VKBA 3344 | 992 894 | VKBA 3306 | 102 156 | 0.026913 |
| 981 744 | VKBA 1342 | 992 894 | VKBA 3324 | 102 207 | 0.027167 |
| 981 745 | VKBA 3345 |         |           | 102 266 | 0.026453 |
| 981 747 | VKBA 3346 |         |           | 102 268 | 0.026597 |
| 981 763 | VKBA 3739 |         |           | 131 129 | 0.026988 |
| 981 790 | VKBA 534  |         |           | 132 131 | 0.026989 |
| 981 798 | VKBA 1907 |         |           | 190 256 | 0.026840 |
| 981 805 | VKBA 3763 |         |           | 191 272 | 0.026326 |
| 981 814 | VKBA 527  |         |           | 192 274 | 0.026327 |
| 981 849 | VKBA 3214 |         |           | 200 012 | 0.026431 |
| 981 851 | VKBA 3216 |         |           | 200 020 | 0.026439 |
| 981 856 | VKBA 3729 |         |           | 201 032 | 0.026438 |
| 981 868 | VKBA 3730 |         |           | 201 040 | 0.026437 |
| 981 938 | VKBA 3929 |         |           | 201 084 | 0.026441 |
| 982 195 | VKBA 3931 |         |           | 201 084 | 0.026442 |
| 982 373 | VKBA 1913 |         |           | 201 210 | 0.026904 |
| 982 379 | VKBA 3234 |         |           | 202 026 | 0.026438 |
| 982 379 | VKBA 3342 |         |           | 202 026 | 0.026903 |
| 982 379 | VKBA 3343 |         |           | 202 140 | 0.026863 |
| 982 431 | VKBA 3240 |         |           | 202 142 | 0.026864 |
| 982 431 | VKBA 3241 |         |           | 202 168 | 0.026443 |
| 982 437 | VKBA 1996 |         |           | 202 202 | 0.026432 |
| 982 559 | VKBA 3215 |         |           | 202 204 | 0.026433 |
| 982 561 | VKBA 3217 |         |           | 202 226 | 0.026436 |
| 982 581 | VKBA 1905 |         |           | 202 236 | 0.026434 |
| 982 650 | VKBA 674  |         |           | 202 252 | 0.026430 |
| 982 653 | VKBA 1921 |         |           | 300 004 | 0.026413 |
| 982 685 | VKBA 1966 |         |           | 300 052 | 0.026409 |
| 982 737 | VKBA 3341 |         |           | 300 062 | 0.026399 |
| 982 749 | VKBA 3347 |         |           | 301 006 | 0.026415 |
| 982 762 | VKBA 3728 |         |           | 301 018 | 0.026412 |
| 982 764 | VKBA 675  |         |           | 301 034 | 0.026417 |
| 982 766 | VKBA 1344 |         |           | 301 038 | 0.026420 |
| 982 774 | VKBA 3740 |         |           | 301 118 | 0.026890 |
| 982 778 | VKBA 1345 |         |           | 301 130 | 0.026426 |
| 982 780 | VKBA 1346 |         |           | 301 132 | 0.026823 |
| 982 800 | VKBA 1906 |         |           | 301 151 | 0.026402 |
| 982 811 | VKBA 3764 |         |           | 301 180 | 0.026736 |
| 982 813 | VKBA 3765 |         |           | 301 182 | 0.026895 |
| 982 816 | VKBA 755  |         |           | 301 198 | 0.026900 |
| 982 857 | VKBA 3731 |         |           | 301 200 | 0.026901 |
| 982 857 | VKBA 3732 |         |           | 301 230 | 0.026416 |

| OPTIMAL | SPIDAN   |
|---------|----------|
| 100 002 | 0.026457 |
| 100 014 | 0.026470 |
| 100 022 | 0.026679 |
| 100 022 | 0.026911 |
| 100 036 | 0.026497 |
| 100 036 | 0.026500 |
| 100 053 | 0.027188 |
| 100 056 | 0.026499 |
| 100 090 | 0.026693 |
| 100 090 | 0.027114 |
| 100 098 | 0.026916 |
| 100 098 | 0.026978 |
| 100 098 | 0.027112 |
| 100 098 | 0.027115 |
| 100 099 | 0.026871 |
| 100 206 | 0.026844 |
| 101 010 | 0.026458 |
| 101 016 | 0.026467 |
| 101 016 | 0.026981 |
| 101 024 | 0.026865 |
| 101 044 | 0.026456 |
| 101 064 | 0.026461 |
| 101 102 | 0.026464 |
| 101 108 | 0.026468 |
| 101 110 | 0.026466 |
| 101 111 | 0.026976 |
| 101 113 | 0.027113 |
| 101 128 | 0.026843 |
| 101 128 | 0.027166 |
| 101 145 | 0.026450 |
| 101 147 | 0.026470 |
| 101 250 | 0.026824 |
| 101 264 | 0.026760 |
| 101 270 | 0.026596 |
| 102 008 | 0.026872 |
| 102 041 | 0.027187 |
| 102 054 | 0.026463 |
| 102 055 | 0.027178 |
| 102 060 | 0.026462 |

## VERGLEICHNUMMERNLISTE

### CROSS REFERENCE GUIDE / LISTE DES ÉQUIVALENCES

| OPTIMAL | SPIDAN   | OPTIMAL | SPIDAN   | OPTIMAL | SPIDAN   |
|---------|----------|---------|----------|---------|----------|
| 301 232 | 0.026414 | 402 116 | 0.026384 | 602 340 | 0.026537 |
| 301 244 | 0.026421 | 402 116 | 0.026392 | 602 340 | 0.026718 |
| 301 246 | 0.026422 | 402 116 | 0.026858 | 602 344 | 0.026830 |
| 301 280 | 0.026405 | 402 143 | 0.026902 | 602 344 | 0.026831 |
| 302 046 | 0.026418 | 402 216 | 0.026801 | 602 356 | 0.026812 |
| 302 058 | 0.026737 | 402 242 | 0.026860 | 602 358 | 0.026586 |
| 302 058 | 0.026822 | 402 242 | 0.026861 | 602 388 | 0.026704 |
| 302 074 | 0.026419 | 501 088 | 0.026363 | 602 390 | 0.026535 |
| 302 076 | 0.026425 | 501 092 | 0.026357 | 602 392 | 0.026589 |
| 302 120 | 0.026423 | 501 112 | 0.026365 | 602 406 | 0.026525 |
| 302 122 | 0.026424 | 501 114 | 0.026359 | 602 412 | 0.026524 |
| 302 124 | 0.026850 | 501 114 | 0.026361 | 602 414 | 0.026534 |
| 302 146 | 0.026407 | 501 136 | 0.026810 | 602 416 | 0.026584 |
| 302 160 | 0.026349 | 501 170 | 0.026368 | 602 418 | 0.026582 |
| 302 162 | 0.026788 | 501 184 | 0.026350 | 602 430 | 0.026702 |
| 302 164 | 0.026891 | 501 194 | 0.026352 | 602 512 | 0.026733 |
| 302 166 | 0.026892 | 502 066 | 0.026360 | 602 539 | 0.026703 |
| 302 172 | 0.026348 | 502 068 | 0.026364 | 602 541 | 0.026526 |
| 302 174 | 0.026790 | 502 070 | 0.026358 | 602 584 | 0.026319 |
| 302 176 | 0.026789 | 502 072 | 0.026367 | 602 815 | 0.026528 |
| 302 186 | 0.026899 | 502 134 | 0.026353 | 602 815 | 0.026587 |
| 302 188 | 0.026896 | 502 138 | 0.026855 | 602 821 | 0.026531 |
| 302 190 | 0.026898 | 502 148 | 0.026856 | 602 859 | 0.026533 |
| 302 192 | 0.026912 | 502 158 | 0.026362 | 602 865 | 0.026813 |
| 302 196 | 0.026897 | 502 178 | 0.026355 | 681 504 | 0.026338 |
| 302 234 | 0.026410 | 600 308 | 0.026593 | 681 506 | 0.026803 |
| 302 240 | 0.026787 | 600 334 | 0.026716 | 681 640 | 0.026302 |
| 302 248 | 0.026826 | 600 410 | 0.026489 | 682 420 | 0.026339 |
| 302 254 | 0.026406 | 601 306 | 0.026536 | 682 422 | 0.026340 |
| 302 260 | 0.026862 | 601 336 | 0.026538 | 682 490 | 0.026854 |
| 401 028 | 0.026380 | 601 336 | 0.026591 | 682 492 | 0.026853 |
| 401 042 | 0.026394 | 601 348 | 0.026829 | 682 508 | 0.026804 |
| 401 048 | 0.026386 | 601 384 | 0.026530 | 682 510 | 0.026805 |
| 401 078 | 0.026857 | 601 396 | 0.026532 | 682 642 | 0.026303 |
| 401 082 | 0.026859 | 601 434 | 0.026588 | 700 310 | 0.026486 |
| 401 096 | 0.026734 | 601 440 | 0.026581 | 700 310 | 0.026766 |
| 401 100 | 0.026389 | 601 446 | 0.026493 | 701 302 | 0.026483 |
| 401 104 | 0.026387 | 601 495 | 0.026529 | 701 307 | 0.026870 |
| 401 126 | 0.026391 | 601 502 | 0.026590 | 701 307 | 0.026914 |
| 401 137 | 0.026802 | 601 580 | 0.026318 | 701 326 | 0.026482 |
| 401 214 | 0.026800 | 601 582 | 0.026732 | 701 332 | 0.026479 |
| 401 222 | 0.026375 | 601 654 | 0.026527 | 701 374 | 0.026481 |
| 401 276 | 0.026371 | 601 828 | 0.026583 | 701 404 | 0.026480 |
| 402 030 | 0.026377 | 602 314 | 0.026918 | 701 424 | 0.026341 |
| 402 050 | 0.026388 | 602 320 | 0.026539 | 701 432 | 0.026685 |
| 402 080 | 0.026395 | 602 322 | 0.026717 | 701 726 | 0.026323 |
| 402 080 | 0.026396 | 602 338 | 0.026759 | 701 728 | 0.026678 |

## VERGLEICHNUMMERNLISTE

### CROSS REFERENCE GUIDE / LISTE DES ÉQUIVALENCES

| OPTIMAL | SPIDAN   | OPTIMAL | SPIDAN   | OPTIMAL | SPIDAN   |
|---------|----------|---------|----------|---------|----------|
| 701 826 | 0.026473 | 801 554 | 0.026893 | 882 643 | 0.026834 |
| 702 309 | 0.026905 | 801 574 | 0.026501 | 882 664 | 0.026711 |
| 702 311 | 0.026906 | 801 588 | 0.026541 | 891 466 | 0.026846 |
| 702 311 | 0.026907 | 801 618 | 0.026669 | 891 482 | 0.026783 |
| 702 312 | 0.026484 | 801 644 | 0.026792 | 891 484 | 0.026715 |
| 702 312 | 0.026765 | 801 656 | 0.026634 | 891 486 | 0.026917 |
| 702 313 | 0.026908 | 801 698 | 0.026509 | 891 496 | 0.026835 |
| 702 313 | 0.026909 | 801 750 | 0.026791 | 891 509 | 0.026564 |
| 702 316 | 0.026487 | 801 922 | 0.026504 | 891 520 | 0.026579 |
| 702 328 | 0.026478 | 802 318 | 0.026511 | 891 522 | 0.026576 |
| 702 350 | 0.026686 | 802 324 | 0.026518 | 891 524 | 0.026569 |
| 702 352 | 0.026684 | 802 330 | 0.026697 | 891 536 | 0.026845 |
| 702 426 | 0.026691 | 802 330 | 0.026698 | 891 546 | 0.026571 |
| 702 436 | 0.026324 | 802 368 | 0.026521 | 891 706 | 0.026566 |
| 702 448 | 0.026343 | 802 370 | 0.026520 | 891 822 | 0.026558 |
| 702 452 | 0.026485 | 802 378 | 0.026696 | 892 458 | 0.026577 |
| 702 452 | 0.026488 | 802 394 | 0.026515 | 892 460 | 0.026575 |
| 702 456 | 0.026325 | 802 444 | 0.026818 | 892 468 | 0.026713 |
| 702 462 | 0.026342 | 802 454 | 0.026633 | 892 470 | 0.026714 |
| 702 494 | 0.026689 | 802 464 | 0.026505 | 892 472 | 0.026847 |
| 702 494 | 0.026690 | 802 480 | 0.026512 | 892 474 | 0.026580 |
| 702 514 | 0.026688 | 802 488 | 0.026549 | 892 476 | 0.026572 |
| 702 550 | 0.026687 | 802 526 | 0.026894 | 892 498 | 0.026836 |
| 702 552 | 0.026692 | 802 540 | 0.026709 | 892 668 | 0.026712 |
| 702 586 | 0.026851 | 802 542 | 0.026708 | 892 670 | 0.026570 |
| 702 692 | 0.026677 | 802 556 | 0.026547 | 892 802 | 0.026578 |
| 702 817 | 0.026475 | 802 558 | 0.026707 | 892 804 | 0.026560 |
| 800 304 | 0.026513 | 802 560 | 0.026807 | 892 806 | 0.026568 |
| 800 366 | 0.026817 | 802 562 | 0.026808 | 892 830 | 0.026567 |
| 800 398 | 0.026821 | 802 590 | 0.026635 | 901 427 | 0.026816 |
| 800 400 | 0.026519 | 802 620 | 0.026661 | 901 461 | 0.026671 |
| 800 408 | 0.026508 | 802 646 | 0.026543 | 902 457 | 0.026674 |
| 801 238 | 0.026540 | 802 652 | 0.026542 | 902 459 | 0.026672 |
| 801 342 | 0.026514 | 802 658 | 0.026727 | 911 375 | 0.026649 |
| 801 354 | 0.026837 | 802 720 | 0.026670 | 911 375 | 0.026652 |
| 801 360 | 0.026699 | 802 732 | 0.026839 | 911 377 | 0.026886 |
| 801 372 | 0.026661 | 802 740 | 0.026799 | 911 513 | 0.026644 |
| 801 376 | 0.026820 | 802 748 | 0.026798 | 911 513 | 0.026645 |
| 801 382 | 0.026819 | 880 525 | 0.026556 | 911 600 | 0.026654 |
| 801 402 | 0.026502 | 880 812 | 0.026731 | 911 621 | 0.026646 |
| 801 428 | 0.026809 | 881 507 | 0.026551 | 911 623 | 0.026738 |
| 801 438 | 0.026546 | 881 534 | 0.026742 | 911 629 | 0.026738 |
| 801 442 | 0.026726 | 881 592 | 0.026832 | 911 782 | 0.026647 |
| 801 450 | 0.026700 | 881 594 | 0.026833 | 912 423 | 0.026885 |
| 801 478 | 0.026548 | 881 622 | 0.026710 | 912 471 | 0.026739 |
| 801 500 | 0.026806 | 881 704 | 0.026653 | 912 473 | 0.026658 |
| 801 538 | 0.026503 | 882 598 | 0.026552 | 912 505 | 0.026643 |

**VERGLEICHNUMMERNLISTE**
**CROSS REFERENCE GUIDE / LISTE DES ÉQUIVALENCES**

| <b>OPTIMAL</b> | <b>SPIDAN</b> | <b>OPTIMAL</b> | <b>SPIDAN</b> | <b>OPTIMAL</b> | <b>SPIDAN</b> |
|----------------|---------------|----------------|---------------|----------------|---------------|
| 912 515        | 0.026650      | 952 832        | 0.026637      | 982 650        | 0.026614      |
| 912 530        | 0.026656      | 960 578        | 0.026755      | 982 685        | 0.026910      |
| 912 530        | 0.026740      | 960 578        | 0.026827      | 982 764        | 0.026615      |
| 912 530        | 0.026884      | 960 638        | 0.026876      | 982 766        | 0.026721      |
| 912 532        | 0.026657      | 960 702        | 0.026758      | 982 778        | 0.026620      |
| 920 752        | 0.026636      | 961 503        | 0.026604      | 982 780        | 0.026780      |
| 940 632        | 0.026743      | 961 576        | 0.026719      | 982 816        | 0.026616      |
| 941 497        | 0.026623      | 961 610        | 0.026828      |                |               |
| 941 511        | 0.026329      | 961 680        | 0.026606      | <b>OPTIMAL</b> | <b>TIMKEN</b> |
| 941 602        | 0.026746      | 961 792        | 0.026608      | 100 002        | EK 73513      |
| 941 617        | 0.026744      | 961 796        | 0.026600      | 100 002        | K 80203       |
| 941 634        | 0.026625      | 961 808        | 0.026336      | 100 002        | K 84102       |
| 941 636        | 0.026723      | 961 808        | 0.026675      | 100 014        | EK 78734      |
| 941 700        | 0.026878      | 961 883        | 0.026607      | 100 014        | K 80204       |
| 941 734        | 0.026628      | 962 517        | 0.026603      | 100 022        | EK 74255      |
| 941 786        | 0.026624      | 962 548        | 0.026874      | 100 022        | K 84106       |
| 942 501        | 0.026627      | 962 682        | 0.026610      | 100 036        | EK 73518      |
| 942 566        | 0.026629      | 962 684        | 0.026602      | 100 036        | K 80201       |
| 942 568        | 0.026725      | 962 686        | 0.026337      | 100 053        | EK 78970      |
| 942 569        | 0.026879      | 962 686        | 0.026676      | 100 053        | K 80217       |
| 942 570        | 0.026724      | 962 703        | 0.026877      | 100 056        | EK 73644      |
| 942 619        | 0.026752      | 962 716        | 0.026757      | 100 056        | K 80205       |
| 942 672        | 0.026747      | 962 718        | 0.026756      | 100 090        | EK 74256      |
| 942 674        | 0.026626      | 962 760        | 0.026720      | 100 090        | K 80207       |
| 942 738        | 0.026745      | 962 776        | 0.026605      | 100 091        | EK 74256      |
| 942 754        | 0.026330      | 971 451        | 0.026778      | 100 093        | EK 74256      |
| 942 768        | 0.026750      | 971 575        | 0.026774      | 100 098        | EK 74257      |
| 942 770        | 0.026751      | 971 615        | 0.026770      | 100 098        | K 80214       |
| 942 773        | 0.026880      | 971 627        | 0.026768      | 100 099        | K 80214       |
| 942 788        | 0.026622      | 971 631        | 0.026825      | 100 206        | EK 78747      |
| 942 818        | 0.026748      | 971 635        | 0.026887      | 100 206        | K 84160       |
| 942 820        | 0.026749      | 971 641        | 0.026888      | 101 010        | EK 73592      |
| 951 519        | 0.026639      | 972 453        | 0.026775      | 101 010        | K 84101       |
| 951 604        | 0.026848      | 972 453        | 0.026776      | 101 016        | EK 73603      |
| 951 606        | 0.026753      | 972 465        | 0.026771      | 101 016        | EK 78782      |
| 951 606        | 0.026920      | 972 637        | 0.026889      | 101 016        | K 84105       |
| 951 708        | 0.026333      | 972 639        | 0.026769      | 101 024        | EK 78680      |
| 951 722        | 0.026728      | 972 699        | 0.026777      | 101 024        | K 84107       |
| 951 756        | 0.026638      | 981 447        | 0.026919      | 101 025        | K 83108       |
| 952 593        | 0.026640      | 981 535        | 0.026544      | 101 027        | K 83109       |
| 952 608        | 0.026883      | 981 572        | 0.026619      | 101 029        | K 84110       |
| 952 661        | 0.026729      | 981 690        | 0.026841      | 101 044        | EK 73597      |
| 952 676        | 0.026882      | 981 742        | 0.026618      | 101 044        | EK 78751      |
| 952 678        | 0.026849      | 981 744        | 0.026722      | 101 044        | K 84103       |
| 952 679        | 0.026881      | 981 790        | 0.026612      | 101 064        | EK 73601      |
| 952 710        | 0.026754      | 981 814        | 0.026613      | 101 064        | K 84151       |
| 952 758        | 0.026334      | 982 373        | 0.026782      | 101 102        | EK 73604      |
|                |               |                |               | 101 102        | K 84155       |

## VERGLEICHNUMMERNLISTE

### CROSS REFERENCE GUIDE / LISTE DES ÉQUIVALENCES

| OPTIMAL | TIMKEN   | OPTIMAL | TIMKEN   | OPTIMAL | TIMKEN   |
|---------|----------|---------|----------|---------|----------|
| 101 108 | EK 73605 | 102 266 | K 83105  | 202 142 | K 82517  |
| 101 108 | K 84156  | 102 268 | EK 74267 | 202 153 | EK 78973 |
| 101 110 | EK 73815 | 131 129 | EK 78869 | 202 155 | EK 78976 |
| 101 110 | K 84152  | 131 129 | K 81135  | 202 168 | EK 74244 |
| 101 111 | EK 78822 | 132 131 | EK 78870 | 202 168 | K 82512  |
| 101 111 | K 80208  | 132 131 | K 81136  | 202 202 | EK 73795 |
| 101 113 | EK 78902 | 190 256 | EK 78578 | 202 202 | K 82509  |
| 101 113 | K 80212  | 190 256 | K 83750  | 202 204 | EK 73796 |
| 101 128 | EK 78746 | 191 258 | EK 78597 | 202 204 | K 82511  |
| 101 128 | K 84160  | 191 258 | K 84158  | 202 205 | EK 74303 |
| 101 147 | EK 73514 | 191 272 | EK 73646 | 202 218 | EK 78797 |
| 101 147 | K 80211  | 191 272 | K 84150  | 202 218 | K 82519  |
| 101 209 | EK 78746 | 192 274 | EK 73636 | 202 218 | K 82528  |
| 101 209 | K 84160  | 192 274 | K 84159  | 202 218 | K 83812  |
| 101 250 | EK 73587 | 200 012 | EK 73797 | 202 218 | K 83813  |
| 101 264 | EK 74269 | 200 012 | K 82502  | 202 224 | K 82530  |
| 101 270 | EK 74268 | 200 020 | EK 73725 | 202 226 | EK 73583 |
| 102 008 | EK 73517 | 200 020 | K 82504  | 202 226 | K 82507  |
| 102 008 | EK 73814 | 201 031 | EK 79088 | 202 236 | EK 73582 |
| 102 008 | K 80202  | 201 031 | K 82525  | 202 236 | K 82508  |
| 102 008 | K 84150  | 201 032 | EK 73526 | 202 252 | EK 73577 |
| 102 011 | EK 78998 | 201 032 | K 82506  | 202 252 | K 82503  |
| 102 011 | K 84108  | 201 033 | EK 79086 | 300 004 | EK 73831 |
| 102 041 | EK 74256 | 201 033 | K 82523  | 300 004 | K 81104  |
| 102 041 | K 80216  | 201 035 | EK 79087 | 300 004 | K 81105  |
| 102 054 | EK 73602 | 201 035 | K 82524  | 300 052 | EK 73542 |
| 102 055 | EK 78988 | 201 040 | EK 73584 | 300 052 | K 81102  |
| 102 055 | K 80215  | 201 040 | K 82501  | 300 062 | EK 73546 |
| 102 060 | EK 73606 | 201 043 | EK 79089 | 300 062 | EK 73837 |
| 102 060 | K 84153  | 201 043 | K 82526  | 300 062 | K 81150  |
| 102 069 | K 84111  | 201 084 | EK 74242 | 301 006 | EK 73554 |
| 102 077 | K 83107  | 201 084 | K 82510  | 301 006 | K 81111  |
| 102 079 | K 84109  | 201 087 | K 82529  | 301 018 | EK 73553 |
| 102 094 | EK 73600 | 201 210 | EK 78706 | 301 018 | K 81103  |
| 102 094 | K 84157  | 201 210 | K 82516  | 301 034 | EK 73541 |
| 102 103 | EK 73586 | 201 228 | EK 78767 | 301 034 | K 81109  |
| 102 115 | EK 78903 | 201 228 | K 82518  | 301 038 | EK 73541 |
| 102 115 | K 80213  | 201 262 | EK 78659 | 301 038 | K 81118  |
| 102 150 | EK 73841 | 201 262 | K 82520  | 301 039 | EK 79059 |
| 102 150 | K 84154  | 202 026 | EK 74243 | 301 039 | K 81139  |
| 102 152 | EK 78681 | 202 026 | K 82506  | 301 045 | EK 79100 |
| 102 154 | EK 78682 | 202 059 | EK 79090 | 301 045 | K 81140  |
| 102 154 | K 84161  | 202 059 | K 82527  | 301 118 | EK 78641 |
| 102 156 | EK 78683 | 202 065 | EK 73811 | 301 118 | K 81157  |
| 102 156 | K 84162  | 202 140 | EK 78657 | 301 130 | EK 73559 |
| 102 266 | EK 73791 | 202 140 | K 82513  | 301 130 | K 81122  |
| 102 266 | EK 74267 | 202 142 | EK 78658 | 301 132 | EK 74340 |



## VERGLEICHNUMMERNLISTE

### CROSS REFERENCE GUIDE / LISTE DES ÉQUIVALENCES

| OPTIMAL | TIMKEN   | OPTIMAL | TIMKEN   | OPTIMAL | TIMKEN   |
|---------|----------|---------|----------|---------|----------|
| 301 132 | K 81120  | 302 164 | EK 78642 | 401 082 | EK 78745 |
| 301 139 | EK 78871 | 302 164 | K 81158  | 401 082 | K 82012  |
| 301 139 | K 81133  | 302 166 | EK 78643 | 401 096 | EK 74280 |
| 301 141 | EK 78871 | 302 166 | K 81159  | 401 096 | K 82010  |
| 301 141 | K 81134  | 302 172 | EK 73556 | 401 100 | EK 74394 |
| 301 180 | EK 74232 | 302 172 | K 81151  | 401 100 | K 82050  |
| 301 180 | K 81116  | 302 174 | EK 73556 | 401 104 | EK 74395 |
| 301 182 | EK 78634 | 302 174 | K 81154  | 401 126 | EK 74279 |
| 301 182 | K 81125  | 302 176 | EK 73556 | 401 126 | K 82008  |
| 301 198 | EK 78633 | 302 176 | K 81156  | 401 137 | EK 78571 |
| 301 198 | K 81124  | 302 186 | EK 78635 | 401 137 | K 82051  |
| 301 200 | EK 78633 | 302 186 | K 81126  | 401 137 | K 82066  |
| 301 200 | K 81124  | 302 188 | EK 78636 | 401 212 | EK 78794 |
| 301 230 | EK 73548 | 302 188 | K 81127  | 401 212 | K 82064  |
| 301 230 | K 81101  | 302 190 | EK 78637 | 401 214 | EK 78742 |
| 301 232 | EK 73549 | 302 190 | K 81128  | 401 214 | K 82058  |
| 301 232 | K 81112  | 302 192 | EK 78638 | 401 222 | EK 73562 |
| 301 244 | EK 73557 | 302 192 | K 81129  | 401 222 | K 82001  |
| 301 244 | K 81114  | 302 196 | EK 78639 | 401 277 | EK 73566 |
| 301 246 | EK 73557 | 302 196 | K 81130  | 401 277 | K 82004  |
| 301 246 | K 81114  | 302 208 | EK 73839 | 402 030 | EK 73564 |
| 301 280 | EK 73539 | 302 208 | K 81131  | 402 030 | K 82002  |
| 301 280 | K 81107  | 302 234 | EK 73544 | 402 050 | EK 74346 |
| 302 037 | EK 78638 | 302 234 | K 81106  | 402 050 | K 82053  |
| 302 037 | K 81138  | 302 240 | EK 74234 | 402 063 | EK 79052 |
| 302 046 | EK 73545 | 302 240 | K 81132  | 402 063 | K 82016  |
| 302 046 | K 81110  | 302 248 | EK 74343 | 402 080 | EK 74322 |
| 302 057 | EK 79060 | 302 248 | K 81121  | 402 080 | K 82007  |
| 302 057 | K 81141  | 302 254 | K 81108  | 402 116 | EK 73568 |
| 302 058 | EK 74341 | 302 260 | EK 78640 | 402 116 | K 82005  |
| 302 058 | K 81117  | 302 260 | K 81123  | 402 117 | EK 78933 |
| 302 067 | EK 79127 | 400 051 | EK 78978 | 402 117 | K 82067  |
| 302 067 | K 81137  | 400 051 | K 82017  | 402 119 | EK 78934 |
| 302 074 | EK 73580 | 400 061 | EK 79091 | 402 119 | K 82065  |
| 302 074 | K 81110  | 400 061 | K 82014  | 402 143 | EK 78832 |
| 302 076 | EK 73580 | 400 107 | EK 78995 | 402 143 | K 82063  |
| 302 076 | K 81119  | 400 107 | K 82068  | 402 216 | EK 78743 |
| 302 120 | EK 73558 | 401 028 | EK 73561 | 402 216 | K 82057  |
| 302 120 | K 81115  | 401 028 | K 82003  | 402 242 | EK 78833 |
| 302 122 | EK 73558 | 401 042 | EK 74265 | 402 242 | K 82013  |
| 302 122 | K 81115  | 401 042 | K 82006  | 501 088 | EK 73529 |
| 302 124 | EK 74344 | 401 047 | EK 79051 | 501 088 | K 80506  |
| 302 124 | K 81155  | 401 047 | K 82015  | 501 092 | EK 73523 |
| 302 146 | K 81113  | 401 048 | EK 73567 | 501 092 | K 80519  |
| 302 160 | EK 73842 | 401 048 | K 82009  | 501 112 | EK 73529 |
| 302 162 | EK 73552 | 401 078 | EK 78744 | 501 112 | K 80510  |
| 302 162 | K 81153  | 401 078 | K 82011  | 501 114 | EK 73532 |

## VERGLEICHNUMMERNLISTE

### CROSS REFERENCE GUIDE / LISTE DES ÉQUIVALENCES

| OPTIMAL | TIMKEN   | OPTIMAL | TIMKEN   | OPTIMAL | TIMKEN   |
|---------|----------|---------|----------|---------|----------|
| 501 114 | K 80508  | 600 410 | K 83602  | 602 341 | EK 78892 |
| 501 114 | K 80513  | 601 306 | EK 73469 | 602 341 | K 80731  |
| 501 121 | EK 78904 | 601 306 | K 82613  | 602 343 | EK 78895 |
| 501 121 | K 80520  | 601 323 | EK 78999 | 602 343 | K 82655  |
| 501 133 | EK 78847 | 601 323 | K 80734  | 602 344 | EK 74309 |
| 501 133 | K 80524  | 601 336 | EK 73455 | 602 344 | K 82618  |
| 501 136 | EK 78613 | 601 336 | K 80710  | 602 345 | EK 78893 |
| 501 136 | K 80516  | 601 348 | EK 74291 | 602 345 | K 80729  |
| 501 170 | EK 74259 | 601 348 | K 80720  | 602 347 | EK 78896 |
| 501 170 | K 80515  | 601 384 | EK 73461 | 602 347 | K 80732  |
| 501 184 | EK 73519 | 601 384 | K 82610  | 602 349 | EK 78897 |
| 501 184 | K 80503  | 601 396 | EK 73449 | 602 349 | K 80733  |
| 501 194 | EK 73512 | 601 396 | K 83605  | 602 356 | EK 74292 |
| 501 194 | K 80501  | 601 434 | EK 73452 | 602 356 | K 80721  |
| 502 066 | EK 73533 | 601 434 | K 80717  | 602 358 | EK 73448 |
| 502 066 | K 80514  | 601 440 | EK 73444 | 602 358 | K 80716  |
| 502 068 | EK 78616 | 601 440 | K 80701  | 602 361 | EK 78894 |
| 502 068 | K 80507  | 601 446 | EK 73511 | 602 361 | K 82654  |
| 502 070 | EK 73534 | 601 446 | K 83601  | 602 367 | EK 78862 |
| 502 070 | K 80509  | 601 495 | EK 73459 | 602 367 | K 82653  |
| 502 072 | EK 74258 | 601 495 | K 82604  | 602 369 | EK 78949 |
| 502 072 | K 80511  | 601 502 | EK 73453 | 602 369 | K 82652  |
| 502 109 | EK 79011 | 601 502 | K 80709  | 602 386 | K 80735  |
| 502 109 | K 80526  | 601 580 | EK 73471 | 602 388 | EK 74254 |
| 502 123 | EK 78905 | 601 580 | K 82650  | 602 388 | K 80723  |
| 502 123 | K 80521  | 601 582 | EK 78603 | 602 390 | EK 73466 |
| 502 125 | EK 78906 | 601 654 | EK 73465 | 602 390 | K 82612  |
| 502 125 | EK 79106 | 601 654 | K 83605  | 602 392 | EK 73451 |
| 502 125 | K 80522  | 601 828 | EK 73446 | 602 392 | K 80727  |
| 502 134 | EK 73522 | 601 828 | K 80705  | 602 406 | EK 73463 |
| 502 134 | K 80502  | 601 916 | EK 79093 | 602 406 | K 82611  |
| 502 135 | EK 78848 | 601 916 | K 82619  | 602 412 | EK 73464 |
| 502 135 | K 80523  | 602 314 | EK 78617 | 602 412 | K 82609  |
| 502 135 | K 80525  | 602 314 | K 80722  | 602 414 | EK 73456 |
| 502 138 | EK 78614 | 602 320 | EK 73491 | 602 414 | K 80708  |
| 502 138 | K 80517  | 602 320 | K 80712  | 602 416 | EK 73447 |
| 502 148 | EK 78615 | 602 322 | EK 74210 | 602 416 | K 80706  |
| 502 148 | K 80518  | 602 322 | K 80719  | 602 418 | EK 73444 |
| 502 158 | K 80512  | 602 337 | EK 78875 | 602 418 | K 80702  |
| 502 178 | EK 73521 | 602 337 | K 80728  | 602 430 | EK 73467 |
| 502 178 | EK 73524 | 602 338 | EK 74247 | 602 512 | EK 78604 |
| 502 178 | K 80505  | 602 338 | K 82617  | 602 539 | EK 73468 |
| 600 308 | EK 73470 | 602 339 | EK 78873 | 602 541 | K 82605  |
| 600 308 | K 82615  | 602 339 | K 80730  | 602 584 | EK 73472 |
| 600 334 | EK 74209 | 602 340 | EK 73454 | 602 645 | K 82620  |
| 600 334 | K 80718  | 602 340 | K 82616  | 602 815 | EK 73450 |
| 600 410 | EK 73508 | 602 341 | EK 78873 | 602 815 | K 82602  |

## VERGLEICHSDATENLISTE

### CROSS REFERENCE GUIDE / LISTE DES ÉQUIVALENCES

| OPTIMAL | TIMKEN   | OPTIMAL | TIMKEN   | OPTIMAL | TIMKEN   |
|---------|----------|---------|----------|---------|----------|
| 602 821 | EK 73468 | 682 642 | K 80753  | 702 311 | EK 78708 |
| 602 858 | EK 79094 | 682 892 | EK 78735 | 702 311 | K 82930  |
| 602 858 | K 80737  | 682 911 | EK 73787 | 702 312 | EK 74342 |
| 602 859 | EK 73462 | 682 920 | EK 73800 | 702 312 | EK 79072 |
| 602 859 | K 82606  | 682 920 | EK 73824 | 702 312 | K 82912  |
| 602 865 | EK 73445 | 682 920 | K 80353  | 702 312 | K 82965  |
| 602 865 | K 80703  | 682 921 | EK 73787 | 702 313 | EK 78712 |
| 602 926 | K 80738  | 682 921 | K 80352  | 702 313 | K 82934  |
| 602 927 | K 82621  | 682 925 | K 80759  | 702 316 | EK 73500 |
| 681 303 | EK 78804 | 700 310 | EK 73499 | 702 316 | K 82915  |
| 681 303 | K 80724  | 700 310 | K 82917  | 702 321 | EK 79000 |
| 681 325 | EK 78786 | 701 302 | EK 73490 | 702 321 | K 82949  |
| 681 325 | K 80755  | 701 302 | K 82911  | 702 328 | EK 73477 |
| 681 504 | EK 73820 | 701 302 | K 82921  | 702 328 | K 82909  |
| 681 504 | K 80750  | 701 307 | EK 78772 | 702 350 | EK 73480 |
| 681 506 | EK 74355 | 701 307 | K 82931  | 702 350 | K 82904  |
| 681 506 | EK 78784 | 701 307 | K 82962  | 702 351 | EK 78866 |
| 681 506 | K 80754  | 701 319 | EK 73490 | 702 351 | K 82939  |
| 681 640 | EK 73457 | 701 319 | K 82921  | 702 352 | EK 74307 |
| 681 640 | K 80752  | 701 326 | EK 73492 | 702 352 | K 82923  |
| 681 907 | EK 73817 | 701 326 | K 82913  | 702 353 | EK 78775 |
| 681 907 | K 80355  | 701 332 | EK 73482 | 702 353 | K 82938  |
| 681 909 | K 83263  | 701 332 | K 82908  | 702 355 | EK 78774 |
| 681 910 | K 83264  | 701 346 | EK 73499 | 702 355 | K 82937  |
| 681 919 | EK 73741 | 701 346 | K 82927  | 702 357 | EK 78773 |
| 681 919 | K 80350  | 701 374 | EK 73487 | 702 357 | K 82936  |
| 681 923 | K 80758  | 701 374 | K 82907  | 702 359 | EK 78868 |
| 681 924 | K 80760  | 701 404 | EK 73479 | 702 359 | K 82941  |
| 682 305 | EK 78805 | 701 404 | K 82914  | 702 363 | EK 78662 |
| 682 305 | K 80725  | 701 424 | EK 78713 | 702 363 | K 82942  |
| 682 327 | EK 78785 | 701 424 | K 82952  | 702 365 | EK 78779 |
| 682 327 | K 80756  | 701 432 | EK 73483 | 702 365 | K 82943  |
| 682 329 | EK 78787 | 701 432 | K 82910  | 702 380 | EK 73501 |
| 682 329 | K 80757  | 701 726 | EK 73493 | 702 380 | K 82916  |
| 682 420 | EK 73821 | 701 726 | K 82950  | 702 426 | EK 78776 |
| 682 420 | K 80751  | 701 728 | EK 73493 | 702 426 | K 82918  |
| 682 422 | EK 73821 | 701 728 | K 82957  | 702 436 | EK 73494 |
| 682 422 | K 80751  | 701 826 | EK 73478 | 702 436 | K 82951  |
| 682 490 | EK 78619 | 701 826 | K 82903  | 702 448 | EK 73496 |
| 682 490 | K 83259  | 701 852 | EK 79075 | 702 448 | K 82954  |
| 682 492 | EK 78618 | 701 852 | K 82945  | 702 452 | EK 74323 |
| 682 492 | K 83259  | 701 860 | EK 79073 | 702 452 | K 82932  |
| 682 508 | EK 78598 | 701 860 | K 82959  | 702 456 | EK 73461 |
| 682 508 | K 83257  | 701 914 | EK 79139 | 702 456 | K 82955  |
| 682 510 | EK 78599 | 701 914 | K 82966  | 702 462 | EK 73495 |
| 682 510 | K 83257  | 702 309 | EK 78710 | 702 462 | K 82953  |
| 682 642 | EK 73458 | 702 309 | K 82961  | 702 494 | EK 78660 |

## VERGLEICHNUMMERNLISTE

### CROSS REFERENCE GUIDE / LISTE DES ÉQUIVALENCES

| OPTIMAL | TIMKEN   | OPTIMAL | TIMKEN   | OPTIMAL | TIMKEN   |
|---------|----------|---------|----------|---------|----------|
| 702 494 | K 82926  | 801 382 | EK 74360 | 801 950 | EK 79078 |
| 702 514 | EK 74310 | 801 402 | EK 73622 | 802 315 | EK 78874 |
| 702 514 | K 82920  | 801 402 | K 83205  | 802 315 | K 83237  |
| 702 537 | EK 78778 | 801 428 | EK 74356 | 802 318 | EK 73628 |
| 702 537 | K 82946  | 801 428 | K 80116  | 802 318 | K 83213  |
| 702 550 | EK 73502 | 801 438 | EK 73614 | 802 324 | EK 73628 |
| 702 550 | K 82933  | 801 438 | K 80104  | 802 324 | K 83213  |
| 702 552 | EK 74324 | 801 442 | EK 74238 | 802 324 | K 83228  |
| 702 552 | K 82925  | 801 442 | K 81801  | 802 330 | EK 78771 |
| 702 586 | EK 78664 | 801 450 | EK 74224 | 802 330 | K 83217  |
| 702 586 | K 82958  | 801 450 | K 83220  | 802 330 | K 83223  |
| 702 692 | EK 74231 | 801 478 | EK 73615 | 802 331 | EK 78929 |
| 702 692 | K 82956  | 801 478 | K 80106  | 802 331 | K 81702  |
| 702 817 | EK 73474 | 801 500 | EK 74215 | 802 335 | EK 78901 |
| 702 817 | K 82904  | 801 500 | K 80119  | 802 335 | K 80121  |
| 702 846 | EK 79074 | 801 538 | EK 73626 | 802 368 | EK 74223 |
| 702 846 | K 82960  | 801 538 | K 83201  | 802 368 | K 83219  |
| 702 850 | EK 79040 | 801 543 | EK 74349 | 802 370 | EK 74222 |
| 702 850 | K 82964  | 801 543 | K 83105  | 802 370 | K 83222  |
| 702 866 | EK 79002 | 801 554 | EK 73836 | 802 378 | EK 74339 |
| 702 866 | K 82947  | 801 554 | K 80113  | 802 378 | K 83224  |
| 702 915 | K 82940  | 801 574 | EK 73621 | 802 394 | EK 73632 |
| 800 304 | EK 73630 | 801 574 | K 83204  | 802 394 | K 83215  |
| 800 304 | K 83210  | 801 588 | EK 73607 | 802 444 | EK 74358 |
| 800 366 | EK 74357 | 801 588 | K 80101  | 802 444 | K 83229  |
| 800 366 | K 83225  | 801 618 | EK 73716 | 802 454 | EK 73711 |
| 800 398 | EK 78770 | 801 618 | K 83101  | 802 454 | K 81802  |
| 800 398 | K 83227  | 801 644 | EK 74326 | 802 464 | EK 73625 |
| 800 400 | EK 74221 | 801 644 | K 83252  | 802 464 | K 83202  |
| 800 400 | K 83216  | 801 656 | EK 74236 | 802 480 | EK 73624 |
| 800 408 | EK 73619 | 801 656 | K 81850  | 802 480 | K 83207  |
| 800 408 | K 83212  | 801 694 | EK 74349 | 802 485 | EK 78900 |
| 801 238 | EK 73611 | 801 694 | K 83103  | 802 485 | K 80122  |
| 801 342 | EK 73631 | 801 694 | K 83106  | 802 488 | EK 73792 |
| 801 342 | K 83214  | 801 698 | EK 73623 | 802 488 | K 80118  |
| 801 354 | EK 74347 | 801 698 | K 83206  | 802 526 | EK 78630 |
| 801 354 | K 83210  | 801 730 | EK 78819 | 802 526 | K 83231  |
| 801 360 | EK 74225 | 801 730 | K 83234  | 802 528 | EK 78611 |
| 801 360 | K 83221  | 801 750 | EK 74326 | 802 528 | K 80117  |
| 801 362 | EK 78769 | 801 750 | K 83252  | 802 540 | EK 74271 |
| 801 362 | K 83236  | 801 836 | EK 78977 | 802 540 | K 80115  |
| 801 364 | EK 78768 | 801 836 | K 80123  | 802 542 | EK 74271 |
| 801 364 | K 83235  | 801 838 | EK 79016 | 802 542 | K 80108  |
| 801 372 | EK 73616 | 801 838 | K 80124  | 802 556 | EK 73610 |
| 801 372 | K 81701  | 801 880 | EK 79092 | 802 556 | K 80105  |
| 801 376 | EK 74354 | 801 880 | K 83238  | 802 558 | EK 73610 |
| 801 376 | K 83226  | 801 922 | EK 73620 | 802 558 | K 80114  |

## VERGLEICHNUMMERNLISTE

### CROSS REFERENCE GUIDE / LISTE DES ÉQUIVALENCES

| OPTIMAL | TIMKEN   | OPTIMAL | TIMKEN   | OPTIMAL | TIMKEN   |
|---------|----------|---------|----------|---------|----------|
| 802 560 | EK 74219 | 881 529 | EK 73762 | 882 863 | EK 73727 |
| 802 560 | K 80112  | 881 534 | K 80308  | 882 875 | EK 73747 |
| 802 562 | EK 74220 | 881 564 | EK 73759 | 891 333 | EK 78821 |
| 802 562 | K 80120  | 881 592 | EK 73729 | 891 333 | K 84019  |
| 802 590 | EK 74237 | 881 594 | EK 73840 | 891 466 | EK 78569 |
| 802 590 | K 81851  | 881 594 | EK 74214 | 891 466 | K 84016  |
| 802 620 | EK 73616 | 881 594 | K 80308  | 891 469 | EK 78997 |
| 802 620 | K 81701  | 881 609 | EK 73750 | 891 469 | K 84025  |
| 802 646 | EK 73792 | 881 609 | K 80316  | 891 477 | EK 78996 |
| 802 652 | EK 73608 | 881 622 | EK 73748 | 891 477 | K 84024  |
| 802 652 | K 80102  | 881 622 | K 80303  | 891 482 | EK 74250 |
| 802 658 | EK 74239 | 881 704 | EK 74284 | 891 482 | K 84013  |
| 802 658 | K 81803  | 881 704 | K 80310  | 891 484 | EK 74248 |
| 802 720 | EK 73715 | 881 725 | EK 78953 | 891 484 | K 84009  |
| 802 720 | K 83102  | 881 725 | K 80323  | 891 486 | EK 78684 |
| 802 732 | EK 74350 | 881 871 | EK 73767 | 891 486 | K 84010  |
| 802 732 | K 83104  | 881 879 | EK 73673 | 891 496 | EK 74396 |
| 802 740 | EK 74362 | 882 463 | EK 78714 | 891 496 | K 83805  |
| 802 740 | K 83261  | 882 463 | K 80320  | 891 520 | EK 73709 |
| 802 748 | EK 74327 | 882 483 | EK 78954 | 891 520 | K 84005  |
| 802 748 | K 83253  | 882 483 | K 80322  | 891 522 | EK 73709 |
| 802 839 | EK 79117 | 882 487 | EK 78952 | 891 522 | K 84007  |
| 802 839 | K 80125  | 882 487 | K 80321  | 891 524 | EK 78766 |
| 802 870 | EK 79010 | 882 491 | EK 73804 | 891 524 | K 83803  |
| 802 870 | K 80128  | 882 531 | EK 73763 | 891 536 | EK 78568 |
| 802 886 | EK 78971 | 882 598 | EK 73745 | 891 544 | EK 78802 |
| 802 886 | K 80127  | 882 598 | K 80302  | 891 544 | K 84017  |
| 802 888 | EK 79046 | 882 607 | K 80330  | 891 546 | EK 73807 |
| 802 888 | K 80126  | 882 611 | EK 73805 | 891 546 | K 83801  |
| 880 419 | EK 78788 | 882 611 | K 80317  | 891 628 | EK 78803 |
| 880 419 | K 83053  | 882 613 | EK 73805 | 891 628 | K 84018  |
| 880 421 | EK 78815 | 882 613 | K 80318  | 891 630 | EK 78796 |
| 880 421 | K 83054  | 882 624 | EK 74286 | 891 630 | K 83807  |
| 880 493 | EK 73759 | 882 624 | K 80315  | 891 706 | EK 78765 |
| 880 525 | EK 73728 | 882 626 | EK 74337 | 891 706 | K 83811  |
| 880 525 | EK 73743 | 882 626 | K 80314  | 891 731 | EK 78647 |
| 880 525 | K 80306  | 882 643 | EK 73816 | 891 731 | K 84020  |
| 880 812 | EK 73764 | 882 643 | K 80319  | 891 822 | EK 73706 |
| 880 812 | K 83050  | 882 664 | EK 73749 | 891 822 | K 84001  |
| 880 912 | EK 79026 | 882 664 | K 80304  | 891 869 | EK 78991 |
| 880 912 | K 83055  | 882 666 | EK 73758 | 891 869 | K 84028  |
| 881 489 | EK 73803 | 882 727 | EK 78755 | 891 878 | EK 79084 |
| 881 507 | EK 73744 | 882 727 | K 80324  | 891 878 | K 84026  |
| 881 507 | K 80301  | 882 729 | EK 78777 | 891 887 | EK 79134 |
| 881 507 | K 80307  | 882 729 | K 80325  | 891 887 | K 83814  |
| 881 523 | EK 73776 | 882 819 | EK 73726 | 892 458 | EK 73710 |
| 881 527 | EK 73731 | 882 861 | EK 73772 | 892 458 | K 84006  |

## VERGLEICHNUMMERNLISTE

### CROSS REFERENCE GUIDE / LISTE DES ÉQUIVALENCES

| OPTIMAL | TIMKEN   | OPTIMAL | TIMKEN   | OPTIMAL | TIMKEN   |
|---------|----------|---------|----------|---------|----------|
| 892 460 | EK 73705 | 901 895 | EK 78624 | 912 515 | EK 73671 |
| 892 460 | K 84008  | 901 896 | EK 78624 | 912 530 | EK 73802 |
| 892 468 | EK 74251 | 902 443 | EK 78622 | 912 530 | K 80312  |
| 892 468 | K 84014  | 902 443 | K 80608  | 912 532 | EK 74285 |
| 892 470 | EK 78791 | 902 457 | EK 74276 | 912 532 | K 80313  |
| 892 470 | K 84011  | 902 457 | K 80603  | 912 545 | EK 78856 |
| 892 472 | EK 78570 | 902 459 | EK 74318 | 912 775 | EK 78777 |
| 892 472 | K 84012  | 902 459 | K 80602  | 912 775 | K 80333  |
| 892 474 | EK 74211 | 902 547 | EK 78910 | 912 803 | EK 79063 |
| 892 474 | K 84004  | 902 771 | EK 78909 | 912 803 | K 80331  |
| 892 476 | EK 73808 | 902 855 | EK 78911 | 920 752 | EK 73688 |
| 892 476 | K 83802  | 902 855 | K 80610  | 920 752 | K 81206  |
| 892 498 | EK 74397 | 902 891 | EK 78594 | 921 553 | EK 78924 |
| 892 498 | K 83806  | 902 897 | EK 78596 | 921 555 | EK 78927 |
| 892 668 | K 83804  | 902 900 | EK 78629 | 922 395 | EK 74261 |
| 892 670 | EK 73703 | 902 901 | EK 78595 | 922 439 | EK 73639 |
| 892 670 | K 83810  | 902 906 | K 80611  | 922 439 | K 81205  |
| 892 733 | EK 78780 | 911 375 | EK 74289 | 922 441 | EK 78623 |
| 892 733 | K 84022  | 911 377 | EK 78748 | 922 441 | K 81202  |
| 892 735 | EK 78820 | 911 377 | EK 78853 | 922 557 | EK 74262 |
| 892 735 | K 84023  | 911 377 | K 80328  | 922 781 | EK 78922 |
| 892 802 | EK 74212 | 911 383 | EK 78781 | 922 781 | K 81204  |
| 892 804 | EK 73708 | 911 383 | K 80329  | 922 783 | EK 78921 |
| 892 806 | EK 73703 | 911 385 | EK 78753 | 922 783 | K 81203  |
| 892 806 | K 83809  | 911 385 | K 80326  | 922 787 | EK 78925 |
| 892 830 | EK 73702 | 911 387 | EK 78754 | 922 789 | EK 78926 |
| 892 830 | K 83808  | 911 387 | K 80327  | 922 797 | EK 78628 |
| 892 843 | EK 78968 | 911 399 | EK 78857 | 922 799 | EK 73639 |
| 892 843 | K 84021  | 911 513 | EK 73673 | 922 854 | EK 78923 |
| 892 872 | EK 79085 | 911 600 | EK 73674 | 931 649 | EK 78585 |
| 892 872 | K 84027  | 911 600 | EK 73707 | 931 663 | EK 78572 |
| 892 929 | K 84029  | 911 600 | K 80309  | 931 669 | EK 78579 |
| 901 425 | EK 78621 | 911 621 | EK 78757 | 931 681 | EK 78626 |
| 901 425 | K 80605  | 911 623 | EK 74227 | 931 697 | EK 78627 |
| 901 427 | EK 74275 | 911 625 | EK 74311 | 931 877 | EK 74300 |
| 901 427 | EK 78685 | 911 629 | EK 74402 | 932 665 | EK 78573 |
| 901 427 | K 80606  | 911 777 | EK 78748 | 932 667 | EK 78577 |
| 901 429 | EK 78620 | 911 782 | EK 74235 | 932 794 | EK 74303 |
| 901 429 | K 80604  | 912 401 | EK 78855 | 932 864 | EK 79050 |
| 901 445 | EK 74282 | 912 403 | EK 78858 | 940 371 | EK 78888 |
| 901 445 | K 80609  | 912 423 | EK 78886 | 940 371 | K 81906  |
| 901 461 | EK 74275 | 912 423 | K 80332  | 940 632 | EK 74299 |
| 901 461 | K 80601  | 912 471 | EK 73752 | 940 632 | K 81904  |
| 901 549 | EK 78626 | 912 471 | EK 74345 | 941 497 | EK 73683 |
| 901 549 | K 80607  | 912 471 | K 80311  | 941 511 | EK 73685 |
| 901 885 | EK 78625 | 912 473 | EK 74298 | 941 563 | EK 78795 |
| 901 890 | EK 78593 | 912 505 | EK 73671 | 941 565 | EK 74283 |

## VERGLEICHNUMMERNLISTE

### CROSS REFERENCE GUIDE / LISTE DES ÉQUIVALENCES

| OPTIMAL | TIMKEN   | OPTIMAL | TIMKEN   | OPTIMAL | TIMKEN   |
|---------|----------|---------|----------|---------|----------|
| 941 602 | EK 74301 | 942 770 | K 81902  | 952 769 | K 81217  |
| 941 602 | K 81910  | 942 773 | EK 78930 | 952 832 | EK 73687 |
| 941 617 | EK 74315 | 942 773 | K 81908  | 960 578 | EK 74252 |
| 941 634 | EK 73678 | 942 788 | EK 73677 | 960 578 | K 82311  |
| 941 636 | EK 74240 | 942 818 | EK 74302 | 960 638 | EK 78752 |
| 941 636 | K 81903  | 942 820 | EK 74302 | 960 638 | K 82307  |
| 941 647 | EK 78584 | 951 409 | EK 78942 | 960 702 | EK 74293 |
| 941 673 | EK 78816 | 951 409 | K 81213  | 960 702 | K 82314  |
| 941 687 | EK 78793 | 951 449 | EK 78651 | 961 411 | EK 78656 |
| 941 689 | EK 78842 | 951 449 | K 81218  | 961 411 | K 82361  |
| 941 700 | EK 78631 | 951 519 | EK 73690 | 961 479 | EK 78690 |
| 941 700 | K 81905  | 951 604 | EK 78647 | 961 479 | K 82319  |
| 941 734 | EK 78689 | 951 604 | K 81219  | 961 503 | EK 73652 |
| 941 784 | EK 78838 | 951 606 | EK 73692 | 961 503 | K 82352  |
| 941 786 | EK 73680 | 951 606 | K 81201  | 961 576 | EK 74213 |
| 941 840 | EK 79017 | 951 657 | EK 78589 | 961 610 | EK 78652 |
| 941 840 | K 81913  | 951 659 | EK 78590 | 961 610 | K 82301  |
| 941 842 | K 81912  | 951 708 | EK 74287 | 961 648 | EK 78798 |
| 941 862 | EK 78762 | 951 708 | K 81209  | 961 648 | K 82315  |
| 941 862 | K 81914  | 951 722 | EK 78582 | 961 675 | EK 78675 |
| 941 873 | EK 73684 | 951 722 | K 81207  | 961 680 | EK 73666 |
| 941 874 | EK 74240 | 951 756 | EK 73689 | 961 680 | K 82320  |
| 941 951 | EK 78861 | 952 405 | EK 78935 | 961 701 | EK 78864 |
| 941 951 | K 81912  | 952 405 | K 81214  | 961 701 | K 82310  |
| 942 381 | EK 78790 | 952 415 | EK 78936 | 961 724 | EK 78688 |
| 942 381 | K 81909  | 952 415 | K 81220  | 961 724 | K 82352  |
| 942 501 | EK 73681 | 952 417 | EK 78938 | 961 751 | EK 78947 |
| 942 566 | EK 73819 | 952 417 | K 81221  | 961 753 | EK 78704 |
| 942 568 | EK 74266 | 952 551 | EK 78937 | 961 759 | EK 78945 |
| 942 569 | EK 78632 | 952 551 | K 81216  | 961 765 | EK 74331 |
| 942 569 | K 81907  | 952 577 | EK 78592 | 961 792 | EK 73652 |
| 942 570 | EK 74266 | 952 593 | EK 73639 | 961 792 | K 82352  |
| 942 619 | EK 78644 | 952 593 | K 81223  | 961 796 | EK 73657 |
| 942 651 | EK 78586 | 952 608 | EK 78648 | 961 796 | K 82305  |
| 942 671 | EK 78831 | 952 608 | K 81222  | 961 801 | EK 74330 |
| 942 672 | EK 74290 | 952 661 | EK 74288 | 961 808 | EK 73818 |
| 942 672 | K 81911  | 952 661 | K 81208  | 961 883 | EK 73663 |
| 942 674 | EK 73679 | 952 676 | EK 78645 | 961 903 | EK 78944 |
| 942 693 | EK 78844 | 952 676 | K 81215  | 961 904 | EK 78655 |
| 942 695 | EK 78845 | 952 678 | EK 78646 | 961 904 | K 82350  |
| 942 736 | EK 78801 | 952 678 | K 81212  | 962 413 | EK 78764 |
| 942 738 | EK 73514 | 952 679 | EK 73691 | 962 413 | K 82362  |
| 942 738 | EK 78689 | 952 710 | EK 74261 | 962 435 | EK 74331 |
| 942 754 | EK 73686 | 952 710 | K 81211  | 962 481 | EK 78691 |
| 942 768 | EK 74278 | 952 758 | EK 74312 | 962 481 | K 82304  |
| 942 768 | K 81901  | 952 758 | K 81210  | 962 517 | EK 73661 |
| 942 770 | EK 74278 | 952 769 | EK 78939 | 962 548 | EK 78653 |

## VERGLEICHNUMMERNLISTE

### CROSS REFERENCE GUIDE / LISTE DES ÉQUIVALENCES

| OPTIMAL | TIMKEN   | OPTIMAL | TIMKEN   | OPTIMAL | TIMKEN   |
|---------|----------|---------|----------|---------|----------|
| 962 548 | K 82302  | 971 455 | EK 78669 | 972 721 | EK 78668 |
| 962 601 | EK 74332 | 971 455 | K 83401  | 972 721 | K 83406  |
| 962 603 | EK 78654 | 971 567 | EK 73812 | 972 793 | EK 74262 |
| 962 605 | EK 78676 | 971 567 | K 82522  | 972 918 | EK 79041 |
| 962 682 | EK 73649 | 971 575 | EK 78670 | 980 614 | EK 78836 |
| 962 682 | K 82306  | 971 575 | K 83403  | 980 614 | K 83706  |
| 962 684 | EK 73653 | 971 612 | EK 78673 | 981 407 | EK 78723 |
| 962 684 | K 82353  | 971 612 | K 83452  | 981 447 | EK 78678 |
| 962 686 | EK 73665 | 971 615 | EK 74390 | 981 447 | K 83754  |
| 962 703 | EK 78699 | 971 627 | EK 74401 | 981 475 | EK 78729 |
| 962 703 | K 82308  | 971 631 | EK 78562 | 981 475 | K 83707  |
| 962 705 | EK 78700 | 971 635 | EK 78564 | 981 499 | EK 79003 |
| 962 705 | K 82309  | 971 641 | EK 78567 | 981 499 | K 83759  |
| 962 712 | EK 78799 | 971 707 | EK 78811 | 981 533 | EK 79004 |
| 962 712 | K 82318  | 971 711 | EK 78670 | 981 533 | K 83760  |
| 962 714 | EK 78800 | 971 711 | K 83404  | 981 535 | EK 73640 |
| 962 714 | K 82317  | 971 723 | EK 78717 | 981 535 | K 80103  |
| 962 716 | EK 74294 | 971 723 | K 83408  | 981 572 | EK 74313 |
| 962 716 | K 82313  | 971 791 | EK 78907 | 981 579 | EK 78581 |
| 962 718 | EK 74253 | 971 795 | EK 78908 | 981 579 | K 83752  |
| 962 718 | K 82312  | 971 917 | EK 79039 | 981 616 | EK 74281 |
| 962 755 | EK 78946 | 972 389 | EK 73797 | 981 655 | EK 78588 |
| 962 757 | EK 78943 | 972 389 | K 80403  | 981 683 | EK 78677 |
| 962 760 | EK 73667 | 972 397 | EK 78658 | 981 683 | K 83755  |
| 962 762 | EK 73662 | 972 397 | K 80404  | 981 690 | EK 78580 |
| 962 767 | EK 78948 | 972 453 | EK 78668 | 981 690 | K 83721  |
| 962 776 | EK 73662 | 972 453 | EK 78718 | 981 742 | EK 73809 |
| 962 776 | K 80107  | 972 453 | K 83402  | 981 742 | K 83727  |
| 962 779 | EK 78879 | 972 465 | EK 78563 | 981 743 | EK 78962 |
| 962 810 | EK 78889 | 972 571 | EK 78672 | 981 743 | K 83716  |
| 962 841 | EK 78654 | 972 571 | K 83451  | 981 744 | EK 74317 |
| 962 841 | K 82363  | 972 573 | EK 73813 | 981 744 | K 83724  |
| 962 847 | EK 78840 | 972 573 | K 82521  | 981 745 | EK 78963 |
| 962 853 | EK 78741 | 972 633 | EK 74391 | 981 745 | K 83715  |
| 962 899 | EK 78654 | 972 637 | EK 78565 | 981 747 | EK 74333 |
| 962 899 | K 82351  | 972 639 | EK 78566 | 981 747 | K 83722  |
| 962 905 | EK 78654 | 972 688 | EK 78674 | 981 763 | EK 79007 |
| 962 905 | K 82364  | 972 688 | K 83453  | 981 763 | K 83734  |
| 962 913 | K 82365  | 972 699 | EK 78719 | 981 790 | EK 73637 |
| 962 949 | EK 78705 | 972 699 | K 83412  | 981 790 | K 83710  |
| 971 391 | EK 78813 | 972 709 | EK 78792 | 981 798 | EK 78576 |
| 971 391 | K 80401  | 972 715 | EK 78958 | 981 805 | EK 78880 |
| 971 393 | EK 73526 | 972 715 | K 83409  | 981 814 | EK 73638 |
| 971 393 | K 80402  | 972 717 | EK 78956 | 981 814 | K 83753  |
| 971 451 | EK 78671 | 972 717 | K 83407  | 981 849 | EK 78806 |
| 971 451 | K 83450  | 972 719 | EK 78668 | 981 851 | EK 78808 |
| 971 455 | EK 78667 | 972 719 | K 83405  | 981 851 | K 83728  |



## VERGLEICHSDATENLISTE

### CROSS REFERENCE GUIDE / LISTE DES ÉQUIVALENCES

| OPTIMAL | TIMKEN   | OPTIMAL | TIMKEN   |
|---------|----------|---------|----------|
| 981 856 | EK 79033 | 982 800 | K 83758  |
| 981 856 | K 83729  | 982 811 | EK 79008 |
| 981 868 | EK 79005 | 982 811 | K 83763  |
| 981 868 | K 83730  | 982 813 | EK 79009 |
| 981 938 | EK 79067 | 982 813 | K 83764  |
| 981 944 | EK 78758 | 982 816 | EK 73650 |
| 981 947 | EK 79065 | 982 816 | K 83725  |
| 982 373 | EK 73648 | 982 857 | EK 79006 |
| 982 373 | K 83712  | 982 857 | K 83731  |
| 982 379 | EK 78724 | 982 884 | EK 79036 |
| 982 379 | EK 78964 | 982 884 | K 83762  |
| 982 379 | EK 78965 | 982 939 | EK 79068 |
| 982 379 | K 83703  | 982 948 | EK 79066 |
| 982 379 | K 83717  | 991 898 | EK 79107 |
| 982 379 | K 83718  | 991 902 | EK 78647 |
| 982 431 | EK 78720 | 991 946 | EK 78992 |
| 982 431 | EK 78835 | 992 894 | EK 78882 |
| 982 431 | K 83708  |         |          |
| 982 431 | K 83709  |         |          |
| 982 437 | EK 78810 |         |          |
| 982 437 | K 83713  |         |          |
| 982 559 | EK 78807 |         |          |
| 982 561 | EK 78809 |         |          |
| 982 561 | K 83726  |         |          |
| 982 581 | EK 78574 |         |          |
| 982 581 | K 83751  |         |          |
| 982 650 | EK 73634 |         |          |
| 982 650 | K 83711  |         |          |
| 982 653 | EK 78587 |         |          |
| 982 685 | EK 78679 |         |          |
| 982 685 | K 83757  |         |          |
| 982 737 | EK 78969 |         |          |
| 982 737 | K 83714  |         |          |
| 982 749 | EK 74334 |         |          |
| 982 762 | EK 78966 |         |          |
| 982 762 | K 83733  |         |          |
| 982 764 | EK 73635 |         |          |
| 982 764 | K 83756  |         |          |
| 982 766 | EK 78720 |         |          |
| 982 766 | K 83705  |         |          |
| 982 774 | EK 78990 |         |          |
| 982 774 | K 83761  |         |          |
| 982 778 | EK 74319 |         |          |
| 982 778 | K 83719  |         |          |
| 982 780 | EK 74320 |         |          |
| 982 780 | K 83720  |         |          |
| 982 800 | EK 78575 |         |          |



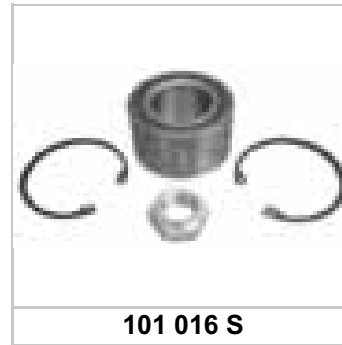



**102 103**

**102 115**

**102 150**

**102 152**

**102 154**

**102 156**

**102 158**

**102 207**

**102 213**

**102 266**

**102 268**

**131 129**

**132 131**

**190 256**

**191 258**

**191 272**

**192 274**

**200 012**

**200 020**

**201 031**



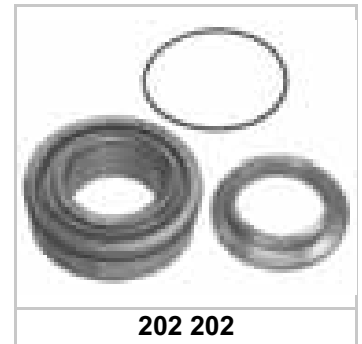







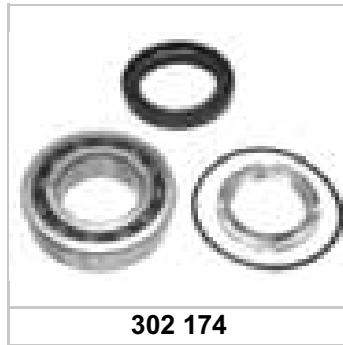











**502 252**

**600 308**

**600 334**

**600 410**

**601 253**

**601 306**

**601 323**

**601 336**

**601 348**

**601 384**

**601 396**

**601 434**

**601 440**

**601 446**

**601 495**

**601 502**

**601 580**

**601 582**

**601 654**

**601 675**









**681 923**

**681 924**

**682 175**

**682 263**

**682 305**

**682 327**

**682 329**

**682 420**

**682 422**

**682 437**

**682 490**

**682 492**

**682 508**

**682 510**

**682 642**

**682 920**

**682 925**

**700 245**

**700 310**

**701 247**





















**881 529**



**881 534**



**881 564**



**881 592**



**881 594**



**881 609**



**881 622**



**881 704**



**881 725**



**881 879**



**882 167**



**882 235**



**882 463**



**882 483**



**882 487**



**882 491**



**882 531**



**882 596**



**882 598**



**882 607**















922 179



922 181



922 187



922 189



922 217



922 219



922 221



922 223



922 395



922 439



922 441



922 557



922 697



922 781



922 783



922 787



922 789



922 854



922 875



922 877









951 722



951 756



951 962



951 971



952 279



952 297



952 405



952 415



952 417



952 551



952 608



952 661



952 676



952 678



952 679



952 710



952 758



952 769



952 832



952 935































|   | (D)                   | (GB)               | (F)                     |
|---|-----------------------|--------------------|-------------------------|
|  | Radnabe               | Wheel hub          | Moyeu Roue              |
|  | Achszapfe             | Wheel swivel       | Fusee Roue              |
|  | Trommelbremsen        | Drum brakes        | Freins à tambour        |
|  | Scheibenbremsen       | Disc brakes        | Freins à disques        |
|  | Räder mit x Löcher    | Wheel with x holes | Roues avec x trous      |
|  | Anzahl der Zahnzacken | Numbers of teeth   | Nombre de dents         |
|  | Linkes Rad            | Left wheel         | Roue gauche             |
|  | Rechtes Rad           | Right wheel        | Roue droite             |
| <b>ABS</b>  | Antiblockiersystem    | Anti block system  | Système d'anti-patinage |
| <b>Ch.</b>  | Fahrgestellnummer     | Chassis No.        | No. de chassis          |
|  | Ohne                  | Without            | Sans                    |





# OPTIMAL

**SYMBOLE**  
**SYMBOLS**  
**SYMBOLES**

|   | <b>PL</b>            | <b>CZ</b>       | <b>E</b>          |
|---|----------------------|-----------------|-------------------|
|  | Piasta koła          | náboj kola      | buje              |
|  | Czop koła            | čep kola        | mangueta          |
|  | Hamulce bębnowe      | bubnové brzdy   | frenos de tambor  |
|  | Hamulce tarczowe     | kotoučové brzdy | frenos de disco   |
|  | Otwory mocujące      | kola s x otvory | ruedas x taleros  |
|  | Lewe koło            | levé kolo       | rueda izquierda   |
|  | Prawe koło           | pravé kolo      | rueda derecha     |
| <b>ABS</b>  | Modele z układem ABS | antibloksystém  | ABS               |
| <b>Ch.</b>  | Numer nadwozia       | Číslo karoserie | números de chasis |
|  | Z wyjątkiem          | kromě           | sin               |



## MODELL/MODEL/MODELE

BEMERKUNGEN/REMARKS/  
REMARQUES

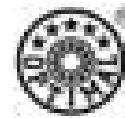

|                             |       |            |  |         |   |
|-----------------------------|-------|------------|--|---------|---|
| Alfa 33                     |       | 88 → 12/89 |  | 04-P209 | - |
| Alfa 33                     |       | 12/89 → -  |  | 04-P215 | - |
| Alfa 33 1.4, 1.7 i.e. 8/16V |       | 91 → 94    |  | 04-P215 | - |
| Alfa 145                    |       | 94 → -     |  | 04-P197 | - |
| Alfa 146                    |       | 94 → -     |  | 04-P197 | - |
| Alfa 155 1.9 TD             | M1    | 93 → 97    |  | 04-P197 | - |
| Alfa 164 2.0, 2.0 TS        | M1,M2 | 87 → 92    |  | 04-P197 | - |
| Alfasud Sprint              |       | 76 → 89    |  | 04-P209 | - |

| MODELL/MODEL/MODELE |  | BEMERKUNGEN/REMARKS/<br>REMARQUES   |  |  |
|---------------------|---|---|---|---|
| 50                  | 74 → 78   |                  | 04-P107   | -   |
| 100, 100 Avant      | 77 → 84   |   | 04-P171   | -   |
| 100, 100 Avant      | 85 → 86   | 4/108   | 04-P171   | -   |
| 100, 100 Avant      | 87 → -  | 4/108, 6 Cyl.   | 04-P171   | -   |
| 100, 100 Avant      | 87 → -  | 4/108, 4 Cyl.   | 04-P171   | -   |
| 100, 100 Avant      | 88 → 91   | 4/108, AT, Ch.44-J-100100 - 44-M-050000   | 04-P171   | -   |
| 100, 100 Avant      | 88 → -  | 4/108, 6 Cyl., Ch.-->44-J-200099  | 04-P171   | -   |
| 100, 100 Avant      | 88 → -  | 4/108, 4 Cyl., Ch.-->44-J-200099  | 04-P171   | -   |
| 100, 100 Avant      | 91 → 94   | 5/112, Ch.4A-M-000001-->  | 04-P157   | -   |
| 80, 90              | 74 → 84   |                  | 04-P105   | -   |
| 80, 90              | 83 → 91   | Avant Quattro   | -   | 04-P171   |
| 80, 90              | 85 → 87   |  Cyl 4           | 04-P105   | -   |
| 80, 90              | 87 → 89   | Ch.89-J-373599-->   | 04-P175   | -   |
| 80, 90              | 87 → 89   | Ch.-->89-J-373598   | 04-P173   | -   |
| 80, 90              | 90 → 91   |   | 04-P175   | -   |
| Coupe Quattro       | 85 → 88   |  Cyl 4           | 04-P105   | -   |
| 80, 90              | 90 → 92   |  Ch.-->8AN200000 | -   | 04-P010   |
| 80, 90              | 92 → -  | <del>AAH, ABC, ACZ</del> , Ch.8C-N-000001 - 8C-N-300000   | 04-P177   | -   |
| 80, 90              | 92 → -  | Ch.8A-N-000001 - 8A-N-200000  | 04-P175   | -   |
| 80, 90              | 93 → 96   | <del>AAH, ABC, ACZ</del>  | 04-P177   | -   |
| A4, A4 Avant        | AAH,ABC,AC...,AF...,AL..  | 95 → -  | 5/112   | 04-P157   |
| A4, A4 Avant        | AD...,AEB,AF...,AH...,1Z  | 95 → -  | 5/112   | 04-P179   |
| A6, A6 Avant        |   | 95 → 01   |   | 04-P157   |
| A6, A6 Avant        | AEB   | 98 → 01   | A.T.  | 04-P157   |
| A6, A6 Avant        | AEB   | 98 → 01   | M.T.  | 04-P179   |
| Quattro             |   | 88 → 91   | 4 Cyl.  | 04-P171   |





| MODELL/MODEL/MODELE                  |               | BEMERKUNGEN/REMARKS/<br>REMARQUES |         |   |
|--------------------------------------|---------------|-----------------------------------|---------|---|
| AX                                   | 07/86 → 12/98 |                                   | 04-P189 | - |
| C 15 Diesel                          | 07/86 → 12/97 |                                   | 04-P187 | - |
| C 15 1124ccm                         | 07/88 → 12/96 |                                   | 04-P187 | - |
| C 15 1360ccm                         | 05/91 → 12/96 |                                   | 04-P187 | - |
| Evasion                              | 06/94 → 02    |                                   | 04-P193 | - |
| Saxo                                 | 05/96 → -     | Ch.-->8093                        | 04-P187 | - |
| Saxo                                 | 05/96 → -     | Ch.8094-->                        | 04-P195 | - |
| Visa                                 | 78 → 91       |                                   | 04-P187 | - |
| Xsara Break 1.4, 1.6, Coupe 1.4, 1.6 | 97 → -        |                                   | 04-P195 | - |
| ZX 1.4                               | 03/91 → 97    |                                   | 04-P187 | - |
| ZX 1.6, 1.7, 1.8, 1.9                | 03/91 → 97    | ABS                               | 04-P191 | - |
| C 25 serie I                         | - → 85        |                                   | 04-P207 | - |
| C 25 serie II                        | 85 → 89       |                                   | 04-P183 | - |
| C 25 serie III                       | 89 → -        |                                   | 04-P205 | - |
| C 25                                 | 94 → -        | 1000 - 1400 kg                    | 04-P185 | - |
| Jumper 1800 kg                       | 89 → -        |                                   | 04-P181 | - |
| Jumper                               | 94 → -        | 1000 -1400 kg                     | 04-P185 | - |



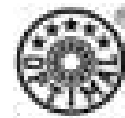

| MODELL/MODEL/MODELE                            |           |           | BEMERKUNGEN/REMARKS/<br>REMARQUES |  |  |  |
|--|-----------|-----------|-----------------------------------|--|---|---|
| Ducato   | serie I   | - → 85    |                                   |  | 04-P207   | -   |
| Ducato   | serie II  | 85 → 89   |                                   |  | 04-P183   | -   |
| Marea  |           | 99 → 02   |                                   |  | 04-P183   | -   |
| Multipla                                       |           | 98 → -    |                                   |  | 04-P183   | -   |
| Punto  |           | 99 → -    |                                   |  | 04-P183   | -   |
| Ducato   |           | 89 → -    | 1800 kg                           |  | 04-P181   | -   |
| Ducato   | serie III | 89 → -    |                                   |  | 04-P205   | -   |
| Ducato   |           | 94 → -    | 1000 -1400 kg                     |  | 04-P185   | -   |
| Scudo  |           | 02/96 → - |                                   |  | 04-P193   | -   |
| Talento  |           | 89 → -    |                                   |  | 04-P205   | -   |
| Ulysse 1.8, 1.9 TD, 2.0, 2.0 16V, 2.0 JTD, 2.0 |           | 94 → 02   |                                   |  | 04-P193   | -   |





| MODELL/MODEL/MODELE                  |  | BEMERKUNGEN/REMARKS/<br>REMARQUES |  |
|--------------------------------------|---|-----------------------------------|---|
| Cougar 2.0 16V                       | 08/98 → -   |                                   | 04-P141 -   |
| Escort                               | 80 → 08/90  |                                   | 04-P135 -   |
| Escort 1.4, 1.6, 1.8, 2.0, 1.8 D     | 09/90 → 01/95   |                                   | 04-P139 -   |
| Escort V, VI, VII 1.6 4x4            | 07/94 → 01/95   |                                   | 04-P137 -   |
| Escort 2.0 EFI 16V 4x4               | 01/95 → 09/01   |                                   | 04-P137 -   |
| Fiesta                               | 01/87 → 88  |                                   | 04-P135 -   |
| Fiesta                               | 89 → 01/94  |                                   | 04-P137 -   |
| Fiesta                               | 01/94 → 08/96   |                                   | 04-P139 -   |
| Galaxy                               | 96 → -  |                                   | 04-P143 -   |
| Ka                                   | 09/96 → -   |                                   | 04-P139 -   |
| Mondeo                               | 93 → 11/00  |                                   | 04-P141 -   |
| Orion                                | 80 → 08/80  |                                   | 04-P135 -   |
| Orion 1.4, 1.6, 1.8, 2.0, 1.8 Diesel | 09/90 → 01/95   |                                   | 04-P139 -   |
| Puma                                 | 11/97 → -   |                                   | 04-P139 -   |



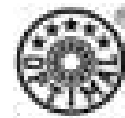

| MODELL/MODEL/MODELE |  | BEMERKUNGEN/REMARKS/<br>REMARQUES |  |
|---------------------|---|-----------------------------------|---|
| Niva                | 76 → -  |                                   | 04-P213 -   |
| Samara              | 86 → -  |                                   | 04-P211 -   |



| MODELL/MODEL/MODELE |  | BEMERKUNGEN/REMARKS/<br>REMARQUES |  |
|---------------------|---|-----------------------------------|---|
| Zeta                | 98 → 02   |                                   | 04-P193 -   |





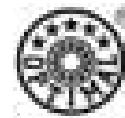

| MODELL/MODEL/MODELE             |  | BEMERKUNGEN/REMARKS/<br>REMARQUES                    |  |           |
|---------------------------------|---|--|---|-----------|
| Ascona C 2.0                    | 82 → 88   |  | 04-P145 -   |           |
| Ascona C 1.6, 1.8               | 82 → 88   |  | 04-P145 -   |           |
| Ascona C 1.3                    | 82 → 88   |  | 04-P149 -   |           |
| Astra F 1.4, 1.6                | 92 → 98   | Ch.-->R2..... R3..., R4....., R5....., R6..... R8..  | 04-P199 -   |           |
| Astra F 1.4, 1.6                | 92 → 98   | Ch.R2....., R3....., R4..... R5....., R6.....R8....- | 04-P149 -   |           |
| Astra F 1.4, 1.6                | 92 → 98   |  | 04-P153 -   |           |
| Astra F 1.6, 1.7 TD             | 92 → 98   |  | 04-P153 -   |           |
| Astra F 1.7D, 1.7 TD            | 92 → 98   |  | 04-P199 -   |           |
| Astra F 1.7D, 1.7 TD            | 92 → 98   |  | 04-P153 -   |           |
| Astra F 1.8                     | 92 → 98   |  | 04-P145 -   |           |
| Astra F 1.8                     | 92 → 98   |  | 04-P147 -   |           |
| Astra F 1.8, 2.0                | 92 → 98   |  | 04-P145 -   |           |
| Astra F 1.8, 2.0                | 92 → 98   |  | 04-P147 -   |           |
| Astra F 1.7                     | 92 → 98   |  | 04-P145 -   |           |
| Astra F 1.7                     | 92 → 98   |  | 04-P147 -   |           |
| Calibra 2.0                     | 89 → 97   | Ch.T1,T9-->  | 04-P147 -   |           |
| Calibra 2.0                     | 89 → 97   | Ch.-->S1, S9   | 04-P145 -   |           |
| Calibra 2.5                     | 89 → 97   | P1000001-->, P9000001-->                             | 04-P151 -   |           |
| Corsa                           | 83 → 92   |  | 04-P149 -   |           |
| Kadett E 1.2, 1.3               | 85 → 93   |  | 04-P149 -   |           |
| Kadett E 1.4, 1.6               | 85 → 93   |  | 04-P149 -   |           |
| Kadett E 1.6, 1.8               | 85 → 93   |  | 04-P145 -   |           |
| Kadett E 1.6, 1.8, 2.0          | 85 → 93   |  | 04-P145 -   |           |
| Kadett E 2.0                    | 85 → 93   |  | 04-P145 -   |           |
| Tigra                           | 93 → -  |  | 04-P149 -   |           |
| Vectra A 1.4                    | 14NV.16SV   | 89 → 95  | M.T.  | 04-P149 - |
| Vectra A 1.6                    | 16SV  | 89 → 95  | A.T.  | 04-P199 - |
| Vectra A 1.6                    | E16NZ,C16NZ,X16SZ   | 89 → 95  |   | 04-P149 - |
| Vectra A 1.6                    |   | 89 → 95  | Ch.-->P1....., P5....., P7....  | 04-P145 - |
| Vectra A 1.6                    |   | 89 → 95  | Ch.R1..... R5..., R75....-->  | 04-P149 - |
| Vectra A 1.8, 2.0               |   | 89 → 95  |   | 04-P145 - |
| Vectra A 1.7D, 1.7TD            |   | 89 → 95  |   | 04-P145 - |
| Vectra B 1.6                    | X16ZR.X16XEL  | 96 → -   |   | 04-P153 - |
| Vectra B 1.6, 2.0, 1.7TD, 2.0TD |   | 96 → -   | Ch.-->W1.....W5..., W7.....   | 04-P147 - |
| Vectra B 1.6, 2.0, 1.7TD, 2.0TD |   | 96 → -   | Ch.X..... X7....-->   | 04-P151 - |
| Vectra B 1.8                    |   | 96 → -   | Ch.-->W1....., W5....., W7....  | 04-P147 - |
| Vectra B 1.8                    |   | 96 → -   | Ch.X1000001-->,X7000001-->  | 04-P151 - |
| Vectra B 2.0                    |   | 96 → -   |   | 04-P151 - |
| Vectra B 2.0 TD                 |   | 96 → -   | Ch.X1000001-->,X7000001-->  | 04-P151 - |





| MODELL/MODEL/MODELE |                 | BEMERKUNGEN/REMARKS/<br>REMARQUES |              |         |   |
|---------------------|-----------------|-----------------------------------|--------------|---------|---|
| 106                 | TU32,TU3M,TU3FJ | 91 →                              | - 4          | 04-P187 | - |
| 106 1.0, 1.1        | TU9,TU1,TU1M    | 91 →                              | - 3          | 04-P189 | - |
| 205                 |                 | 83 →                              | 98 ABS       | 04-P191 | - |
| 205                 |                 | 83 →                              | 98           | 04-P187 | - |
| 206                 |                 | 98 →                              | -            | 04-P195 | - |
| 306                 |                 | 93 →                              | - ABS        | 04-P191 | - |
| 306                 |                 | 93 →                              | - ABS        | 04-P187 | - |
| 309 1.1-1.4         |                 | 85 →                              | - ABS 4 [11] | 04-P187 | - |
| 309 1.4-1.9         |                 | 85 →                              | - ABS        | 04-P191 | - |
| 405                 |                 | 87 →                              | - ABS        | 04-P191 | - |
| 406 I               |                 | 95 →                              | - ABS        | 04-P191 | - |
| 806                 |                 | 94 →                              | -            | 04-P193 | - |
| Boxer 1800 kg       |                 | 89 →                              | -            | 04-P181 | - |
| Boxer 1400 kg       |                 | 94 →                              | -            | 04-P185 | - |
| J 5                 | Serie I         | - →                               | 85           | 04-P207 | - |
| J 5                 | Serie II        | 85 →                              | 89           | 04-P183 | - |
| J 5                 | Serie III       | 89 →                              | -            | 04-P205 | - |

















































































| MODELL/MODEL/MODELE                         |  | BEMERKUNGEN/REMARKS/<br>REMARQUES |  |  |
|---|---|-----------------------------------|---|---|
| Clio 1.1, 1.2, 1.4                          | - → 03/94   |                                   | 04-P161   | -   |
| Clio 1.8, 1.9                               | - → 03/94   |                                   | 04-P163   | -   |
| Clio 1.2, 1.4                               | 04/94 → 03/98   |                                   | 04-P161   | -   |
| Clio 1.2 Ice, 1.2 RL, 1.2 RN                | 04/96 → 03/98   |                                   | 04-P161   | -   |
| Clio 1.2                                    | 04/98 → -   |                                   | 04-P161   | -   |
| Clio 1.4                                    | 04/94 → 03/98   | ABS                               | 04-P163   | -   |
| Clio 1.4, 1.6                               | 04/98 → -   |                                   | 04-P163   | -   |
| Clio 1.4, 1.8                               | 04/96 → 03/98   |                                   | 04-P163   | -   |
| Clio 1.8                                    | 91 → -  | ABS                               | 04-P161   | -   |
| Clio 1.8,1.9 D                              | 04/94 → 03/98   |                                   | 04-P163   | -   |
| Espace                                      | 84 → -  | V6                                | 04-P165   | -   |
| Kangoo                                      | 98 → -  |                                   | 04-P163   | -   |
| Laguna                                      | 93 → -  |                                   | 04-P167   | -   |
| Megane 1.4, 1.6                             | 04/99 → -   |                                   | 04-P163   | -   |
| Megane 1.4, 1.6, 1.9 D, 1.9 TD              | - → 03/99   |                                   | 04-P163   | -   |
| Megane Scenic 1.6 RXT, 1.6 RXE 1.9, 2.0     | 04/99 → -   |                                   | 04-P169   | -   |
| Megane 2.0 Classic RT, 2.0 Coach RT, 2.0 RT | - → 03/99   |                                   | 04-P163   | -   |
| Megane 2.0 Coach RT 16V, 1.9 dt Scenic RT   | - → 03/99   |                                   | 04-P167   | -   |
| R 4   | - → -   |                                   | 04-P203   | -   |
| R 5   | 62 → 93   |                                   | 04-P203   | -   |
| R 5 super                                   | 72 → 85   |                                   | 04-P161   | -   |
| R 6   | 69 → 87   |                                   | 04-P203   | -   |
| R 9   | 81 → 89   |                                   | 04-P161   | -   |
| R 11  | 83 → 89   |                                   | 04-P161   | -   |
| R 19 1.2                                    | - → 05/92   |                                   | 04-P161   | -   |
| R 19 Chamade1.2                             | - → 05/92   |                                   | 04-P161   | -   |
| R 19 1.4, 1.7, 1.8, 1.9 TD                  | - → 05/92   |                                   | 04-P163   | -   |
| R 19 Chamade 1.4, 1.7, 1.8, 1.9 TD          | - → 05/92   |                                   | 04-P163   | -   |
| R 19 1.4, 1.8, 1.9D                         | 06/92 → -   |                                   | 04-P163   | -   |
| R 21 1.4, 1.7                               | 89 → 94   |                                   | 04-P163   | -   |
| R 21 Diesel                                 | 89 → 94   |                                   | 04-P165   | -   |
| R 25  | 84 → 93   | ABS                               | 04-P165   | -   |
| Twingo                                      | - → -   |                                   | 04-P161   | -   |









































































| MODELL/MODEL/MODELE |         | BEMERKUNGEN/REMARKS/<br>REMARQUES |         |         |
|---------------------|---------|-----------------------------------|---------|---------|
| Alhambra            | 96 → 00 |                                   | 04-P201 | -       |
| Alhambra            | 96 → 00 |                                   | -       | 04-P201 |
| Arosa               | 97 → 00 | Ch.→6HX027500  ABS                | -       | 04-P010 |
| Arosa               | 97 → 00 | Ch.→6HX027500  ABS                | -       | 04-P006 |
| Arosa               | - → 03  | with ABS ring                     | 04-P155 | -       |
| Arosa               | 97 → 00 | Ch.→6HX027500  ABS                | -       | 04-P008 |
| Cordoba             | 93 → 01 | ABS                               | 04-P101 | -       |
| Cordoba             | 93 → 01 | ABS                               | 04-P109 | -       |
| Cordoba             | 93 → 99 | Ch.→6KX399999  ABS                | -       | 04-P010 |
| Cordoba             | 93 → 99 | Ch.→6KX399999  ABS                | -       | 04-P006 |
| Cordoba             | 93 → 99 | Ch.→6KX399999  ABS                | -       | 04-P008 |
| Cordoba             | 93 → 99 | Ch.→6KX399999  ABS                | -       | 04-P002 |
| Cordoba             | 93 → 99 | Ch.→6KX399999  ABS                | -       | 04-P004 |
| Ibiza               | - → 92  |                                   | 04-P101 | -       |
| Ibiza               | 93 → 01 | ABS                               | 04-P101 | -       |
| Ibiza               | 93 → 01 | ABS                               | 04-P109 | -       |
| Ibiza               | 93 → 99 | Ch.→6KX399999  ABS                | -       | 04-P010 |
| Ibiza               | 93 → 99 | Ch.→6KX399999  ABS                | -       | 04-P006 |
| Ibiza               | 93 → 99 | Ch.→6KX399999  ABS                | -       | 04-P008 |
| Ibiza               | 93 → 99 | Ch.→6KX399999  ABS                | -       | 04-P002 |
| Ibiza               | 93 → 99 | Ch.→6KX399999  ABS                | -       | 04-P004 |
| Inca                | 97 → 01 | ABS                               | 04-P101 | -       |
| Inca                | 97 → 01 | ABS                               | 04-P109 | -       |
| Toledo              | - → 91  | ABS                               | 04-P101 | -       |
| Toledo              | 92 → 99 | ABS  x4                           | 04-P109 | -       |
| Toledo 2.0 16V      | 92 → 99 | ABS  x5                           | 04-P111 | -       |
| Toledo              | 92 → 99 | ABS                               | 04-P101 | -       |
| Toledo              | 93 → 98 | ABS                               | -       | 04-P010 |
| Toledo              | 93 → 98 | ABS                               | -       | 04-P006 |
| Toledo              | 93 → 98 | ABS                               | -       | 04-P008 |
| Toledo              | 93 → 98 | ABS                               | -       | 04-P002 |
| Toledo              | 93 → 98 | ABS                               | -       | 04-P004 |



| MODELL/MODEL/MODELE   |  | BEMERKUNGEN/REMARKS/<br>REMARQUES |  |  |
|-----------------------|---|-----------------------------------|---|---|
| Favorit 115, 135, 136 | - → 12/93   |                                   | 04-P217   | -   |
| Forman                | - → 12/93   |                                   | 04-P217   | -   |

| MODELL/MODEL/MODELE       |  | BEMERKUNGEN/REMARKS/<br>REMARQUES  |  |  |
|---------------------------|---|--|---|---|
| Bora                      | 99 → 02   |  | 04-P159   | -   |
| Bora 4 Motion             | 99 → 02   |  | 04-P159   | -   |
| Bora                      | 99 → 02   |  | 04-P159   | -   |
| Caddy                     | 83 → 92   |   | 04-P103   | -   |
| Caddy                     | 95 → 01   |  ABS  | 04-P101   | -   |
| Caddy                     | 95 → 01   |  ABS  | 04-P109   | -   |
| Corrado                   | 89 → 95   |  ABS  | 04-P101   | -   |
| Corrado                   | 89 → 95   |  ABS  x4   | 04-P109   | -   |
| Corrado 2.9 VR6           | 89 → 95   |  ABS  x5   | 04-P111   | -   |
| Derby                     | 77 → 90   |   | 04-P107   | -   |
| Golf I                    | 77 → 84   |  Ch.→E29999   | 04-P103   | -   |
| Golf II, III              | 88 → 97   |  ABS  | 04-P101   | -   |
| Golf II, III              | 88 → 97   |  ABS  x4   | 04-P109   | -   |
| Golf III 2.0 GTI, 2.8 VR6 | 92 → 97   |  ABS  x5   | 04-P111   | -   |
| Golf II, III              | 84 → 97   |   ABS  | -   | 04-P010   |
| Golf III                  | 92 → 97   |   ABS                       | -   | 04-P006   |
| Golf III                  | 92 → 97   |   ABS                       | -   | 04-P008   |
| Golf III                  | 92 → 97   |   ABS                    | -   | 04-P002   |
| Golf III                  | 92 → 97   |   ABS                 | -   | 04-P004   |
| Golf Cabriolet            | 79 → 08/93  |   | 04-P103   | -   |
| Golf Cabriolet            | 09/93 → 01  |   | 04-P109   | -   |
| Golf Cabriolet            | 94 → 98   |   ABS  | -   | 04-P010   |
| Golf Cabriolet            | 94 → 98   |   ABS                 | -   | 04-P006   |
| Golf Cabriolet            | 94 → 98   |   ABS                 | -   | 04-P008   |
| Golf Cabriolet            | 94 → 01   |   ABS                 | -   | 04-P002   |
| Golf Cabriolet            | 94 → 01   |   ABS                 | -   | 04-P004   |
| Golf Syncro               | 88 → 91   |  ABS  | 04-P101   | -   |
| Golf Syncro               | 88 → 91   |  ABS  | 04-P109   | -   |
| Golf Syncro               | 93 → 98   |  ABS  x4   | 04-P109   | -   |
| Golf Syncro 2.9 VR6       | 93 → 98   |  ABS  x5   | 04-P111   | -   |
| Golf Syncro               | 86 → 91   |   | -   | 04-P105   |
| Golf Syncro               | 93 → 98   |  Cyl 4  | -   | 04-P105   |
| Golf Variant              | 92 → 99   |  ABS  | 04-P101   | -   |
| Golf Variant              | 92 → 99   |  ABS  | 04-P109   | -   |
| Golf Variant              | 94 → 98   |   ABS  | -   | 04-P010   |
| Golf Variant              | 94 → 98   |   ABS                 | -   | 04-P006   |
| Golf Variant              | 94 → 98   |   ABS                 | -   | 04-P008   |
| Golf Variant              | 94 → 98   |   ABS                 | -   | 04-P002   |
| Golf Variant              | 94 → 98   |   ABS                 | -   | 04-P004   |
| Golf/Variant/4 Motion     | 98 → 02   |  | 04-P159   | -   |
| Jetta                     | 79 → 84   |  Ch.→16E29999   | 04-P103   | -   |
| Jetta                     | 88 → 92   |  ABS  | 04-P101   | -   |
| Jetta                     | 88 → 92   |  ABS  | 04-P109   | -   |
| Jetta                     | 87 → 92   |   ABS  | -   | 04-P010   |
| Jetta Syncro              | 88 → 91   |  ABS  | 04-P101   | -   |
| Jetta Syncro              | 88 → 91   |  ABS  | 04-P109   | -   |
| Jetta Syncro              | 88 → 91   |   | -   | 04-P105   |
| Passat                    | 74 → 03/88  |  Ch.→32J299999  | 04-P105   | -   |
| Passat                    | 04/88 → 02/92   |  ABS  | 04-P101   | -   |
| Passat                    | 04/88 → 02/92   |  ABS  x4   | 04-P109   | -   |
| Passat                    | 88 → 97   |  Ch.→3AV300000  ABS  | -   | 04-P010   |
| Passat                    | 88 → 97   |  Ch.→3AV300000  ABS  | -   | 04-P008   |
| Passat                    | 88 → 97   |  Ch.→3AV300000  ABS  | -   | 04-P002   |
| Passat                    | 88 → 97   |  Ch.→3AV300000  ABS  | -   | 04-P004   |

| MODELL/MODEL/MODELE            |            | BEMERKUNGEN/REMARKS/<br>REMARQUES   |  |  |
|--------------------------------|------------|---|---|---|
| Passat                         | 03/92 → 97 |  ABS  x4 Ch.→3AV300000  | 04-P109   | -   |
| Passat                         | 88 → 97    |  Ch.→3AV300000  ABS        | -   | 04-P006   |
| Passat AD...,AEB,AFY,AGZ,AH..  | 97 → 00    | Ch.3B-V-000001-->, 5 [11]   | 04-P179   | -   |
| Passat ACK,AFN,AGE,AGZ         | 97 → 00    | Ch.3B-V-000001-->, 5 [11]   | 04-P157   | -   |
| Passat ALT,ALZ,AVB,AZM         | 01 → 04    |   | 04-P179   | -   |
| Passat 2.0 16V 110 kW, 2.8 VR6 | 03/92 → 97 |  ABS  x5 Ch.31N255990→3AV300000   | 04-P111   | -   |
| Passat 1.9 TDI 81kW            | 03/92 → 97 |  ABS  x5 Ch.31N255990→3AV300000   | 04-P111   | -   |
| Passat Syncro                  | 85 → 06/91 |  ABS Ch.→31M367757   | -   | 04-P105   |
| Passat Syncro 2.0              | 89 → 97    |  Ch.31M36758→4AV012704   | -   | 04-P101   |
| Passat Syncro 2.0              | 89 → 93    |  ABS   | 04-P109   | -   |
| Passat Syncro 2.0              | 94 → 05/97 |  ABS  x4 Ch.→3AV012704  | 04-P109   | -   |
| Passat Syncro 2.9 VR6          | 94 → 97    |  ABS  x5 Ch.→3AV012704  | 04-P111   | -   |
| Polo                           | 75 → 07/94 |    | 04-P107   | -   |
| Polo                           | 91 → 99    |  Ch.→6NXY37991  ABS   | -   | 04-P010   |
| Polo                           | 95 → 99    |  Ch.→6NXY37991  ABS        | -   | 04-P006   |
| Polo                           | 95 → 99    |  Ch.→6NXY37991  ABS        | -   | 04-P008   |
| Polo                           | 95 → 99    |  Ch.→6NXY37991  ABS        | -   | 04-P002   |
| Polo                           | 95 → 99    |  Ch.→6NXY37991  ABS        | -   | 04-P004   |
| Polo Classic/Variant           | 96 → 01    |  ABS   | 04-P101   | -   |
| Polo Classic/Variant           | 96 → 01    |  ABS   | 04-P109   | -   |
| Polo Classic/Variant           | 96 → 99    |  Ch.→6KX610000  ABS   | -   | 04-P010   |
| Polo Classic/Variant           | 96 → 99    |  Ch.→6KX610000  ABS        | -   | 04-P006   |
| Polo Classic/Variant           | 96 → 99    |  Ch.→6KX610000  ABS     | -   | 04-P008   |
| Polo Classic/Variant           | 97 → 99    |  Ch.→6KX610000  ABS  | -   | 04-P002   |
| Polo Classic/Variant           | 97 → 99    |  Ch.→6KX610000  ABS  | -   | 04-P004   |
| Santana                        | 82 → 85    |    | 04-P105   | -   |
| Scirocco                       | 77 → 92    |    | 04-P103   | -   |
| Vento                          | 92 → 98    |  ABS   | 04-P101   | -   |
| New Beetle                     | 99 → 02    | with ABS ring, 3.2 RSI  | 04-P159   | -   |
| Vento                          | 92 → 98    |  ABS  x4  | 04-P109   | -   |
| Vento 2.0 GTI, 2.8 VR6         | 92 → 98    |  ABS  x5  | 04-P111   | -   |
| Vento                          | 92 → 98    |   ABS   | -   | 04-P010   |
| Vento                          | 92 → 98    |   ABS                | -   | 04-P006   |
| Vento                          | 92 → 98    |   ABS                | -   | 04-P008   |
| Vento                          | 92 → 98    |   ABS                | -   | 04-P002   |
| Vento                          | 92 → 98    |   ABS                | -   | 04-P004   |
| Sharan                         | 96 → 00    |   | 04-P201   | -   |
| Sharan                         | 96 → 00    |   | -   | 04-P201   |

**04-P002**



|            |                      |    |    |   |
|------------|----------------------|----|----|---|
| SEAT       | Cordoba              | 93 | 99 | ✓ |
| SEAT       | Ibiza                | 93 | 99 | ✓ |
| SEAT       | Toledo               | 93 | 98 | ✓ |
| VOLKSWAGEN | Golf III             | 92 | 97 | ✓ |
| VOLKSWAGEN | Golf Cabriolet       | 94 | 01 | ✓ |
| VOLKSWAGEN | Golf Variant         | 94 | 98 | ✓ |
| VOLKSWAGEN | Passat               | 88 | 97 | ✓ |
| VOLKSWAGEN | Polo                 | 95 | 99 | ✓ |
| VOLKSWAGEN | Polo Classic/Variant | 97 | 99 | ✓ |
| VOLKSWAGEN | Vento                | 92 | 98 | ✓ |

**04-P004**



|            |                      |    |    |   |
|------------|----------------------|----|----|---|
| SEAT       | Cordoba              | 93 | 99 | ✓ |
| SEAT       | Ibiza                | 93 | 99 | ✓ |
| SEAT       | Toledo               | 93 | 98 | ✓ |
| VOLKSWAGEN | Golf III             | 92 | 97 | ✓ |
| VOLKSWAGEN | Golf Cabriolet       | 94 | 01 | ✓ |
| VOLKSWAGEN | Golf Variant         | 94 | 98 | ✓ |
| VOLKSWAGEN | Passat               | 88 | 97 | ✓ |
| VOLKSWAGEN | Polo                 | 95 | 99 | ✓ |
| VOLKSWAGEN | Polo Classic/Variant | 97 | 99 | ✓ |
| VOLKSWAGEN | Vento                | 92 | 98 | ✓ |

**04-P006**



|            |                      |    |    |   |
|------------|----------------------|----|----|---|
| SEAT       | Arosa                | 97 | 00 | ✓ |
| SEAT       | Cordoba              | 93 | 99 | ✓ |
| SEAT       | Ibiza                | 93 | 99 | ✓ |
| SEAT       | Toledo               | 93 | 98 | ✓ |
| VOLKSWAGEN | Golf III             | 92 | 97 | ✓ |
| VOLKSWAGEN | Golf Cabriolet       | 94 | 98 | ✓ |
| VOLKSWAGEN | Golf Variant         | 94 | 98 | ✓ |
| VOLKSWAGEN | Passat               | 88 | 97 | ✓ |
| VOLKSWAGEN | Polo                 | 95 | 99 | ✓ |
| VOLKSWAGEN | Polo Classic/Variant | 96 | 99 | ✓ |
| VOLKSWAGEN | Vento                | 92 | 98 | ✓ |

**04-P008**



|            |                      |    |    |   |
|------------|----------------------|----|----|---|
| SEAT       | Arosa                | 97 | 00 | ✓ |
| SEAT       | Cordoba              | 93 | 99 | ✓ |
| SEAT       | Ibiza                | 93 | 99 | ✓ |
| SEAT       | Toledo               | 93 | 98 | ✓ |
| VOLKSWAGEN | Golf III             | 92 | 97 | ✓ |
| VOLKSWAGEN | Golf Cabriolet       | 94 | 98 | ✓ |
| VOLKSWAGEN | Golf Variant         | 94 | 98 | ✓ |
| VOLKSWAGEN | Passat               | 88 | 97 | ✓ |
| VOLKSWAGEN | Polo                 | 95 | 99 | ✓ |
| VOLKSWAGEN | Polo Classic/Variant | 96 | 99 | ✓ |
| VOLKSWAGEN | Vento                | 92 | 98 | ✓ |

**04-P010**



|            |                      |    |    |   |
|------------|----------------------|----|----|---|
| AUDI       | 80, 90               | 90 | 92 | ✓ |
| SEAT       | Arosa                | 97 | 00 | ✓ |
| SEAT       | Cordoba              | 93 | 99 | ✓ |
| SEAT       | Ibiza                | 93 | 99 | ✓ |
| SEAT       | Toledo               | 93 | 98 | ✓ |
| VOLKSWAGEN | Golf II, III         | 84 | 97 | ✓ |
| VOLKSWAGEN | Golf Cabriolet       | 94 | 98 | ✓ |
| VOLKSWAGEN | Golf Variant         | 94 | 98 | ✓ |
| VOLKSWAGEN | Jetta                | 87 | 92 | ✓ |
| VOLKSWAGEN | Passat               | 88 | 97 | ✓ |
| VOLKSWAGEN | Polo                 | 91 | 99 | ✓ |
| VOLKSWAGEN | Polo Classic/Variant | 96 | 99 | ✓ |
| VOLKSWAGEN | Vento                | 92 | 98 | ✓ |

**04-P101**



|      |         |    |    |   |
|------|---------|----|----|---|
| SEAT | Cordoba | 93 | 01 | ✓ |
| SEAT | Ibiza   | -  | 92 | ✓ |
| SEAT | Ibiza   | 93 | 01 | ✓ |
| SEAT | Inca    | 97 | 01 | ✓ |

**04-P101**



|            |                      |       |       |   |
|------------|----------------------|-------|-------|---|
| SEAT       | Toledo               | -     | 91    | ✓ |
| SEAT       | Toledo               | 92    | 99    | ✓ |
| VOLKSWAGEN | Caddy                | 95    | 01    | ✓ |
| VOLKSWAGEN | Corrado              | 89    | 95    | ✓ |
| VOLKSWAGEN | Golf II, III         | 88    | 97    | ✓ |
| VOLKSWAGEN | Golf Syncro          | 88    | 91    | ✓ |
| VOLKSWAGEN | Golf Variant         | 92    | 99    | ✓ |
| VOLKSWAGEN | Jetta                | 88    | 92    | ✓ |
| VOLKSWAGEN | Jetta Syncro         | 88    | 91    | ✓ |
| VOLKSWAGEN | Passat               | 04/88 | 02/92 | ✓ |
| VOLKSWAGEN | Passat Syncro 2.0    | 89    | 97    | ✓ |
| VOLKSWAGEN | Polo Classic/Variant | 96    | 01    | ✓ |
| VOLKSWAGEN | Vento                | 92    | 98    | ✓ |

**04-P103**



|            |                |    |       |   |
|------------|----------------|----|-------|---|
| VOLKSWAGEN | Caddy          | 83 | 92    | ✓ |
| VOLKSWAGEN | Golf I         | 77 | 84    | ✓ |
| VOLKSWAGEN | Golf Cabriolet | 79 | 08/93 | ✓ |
| VOLKSWAGEN | Jetta          | 79 | 84    | ✓ |
| VOLKSWAGEN | Scirocco       | 77 | 92    | ✓ |

**04-P105**

|            |               |    |       |   |
|------------|---------------|----|-------|---|
| AUDI       | 80, 90        | 74 | 84    | ✓ |
| AUDI       | 80, 90        | 85 | 87    | ✓ |
| AUDI       | Coupe Quattro | 85 | 88    | ✓ |
| VOLKSWAGEN | Golf Syncro   | 86 | 91    | ✓ |
| VOLKSWAGEN | Golf Syncro   | 93 | 98    | ✓ |
| VOLKSWAGEN | Jetta Syncro  | 88 | 91    | ✓ |
| VOLKSWAGEN | Passat        | 74 | 03/88 | ✓ |
| VOLKSWAGEN | Passat Syncro | 85 | 06/91 | ✓ |
| VOLKSWAGEN | Santana       | 82 | 85    | ✓ |

**04-P107**

|            |       |    |       |   |
|------------|-------|----|-------|---|
| AUDI       | 50    | 74 | 78    | ✓ |
| VOLKSWAGEN | Derby | 77 | 90    | ✓ |
| VOLKSWAGEN | Polo  | 75 | 07/94 | ✓ |

**04-P109**

|            |                      |       |       |   |
|------------|----------------------|-------|-------|---|
| SEAT       | Cordoba              | 93    | 01    | ✓ |
| SEAT       | Ibiza                | 93    | 01    | ✓ |
| SEAT       | Inca                 | 97    | 01    | ✓ |
| SEAT       | Toledo               | 92    | 99    | ✓ |
| VOLKSWAGEN | Caddy                | 95    | 01    | ✓ |
| VOLKSWAGEN | Corrado              | 89    | 95    | ✓ |
| VOLKSWAGEN | Golf II, III         | 88    | 97    | ✓ |
| VOLKSWAGEN | Golf Cabriolet       | 09/93 | 01    | ✓ |
| VOLKSWAGEN | Golf Syncro          | 88    | 91    | ✓ |
| VOLKSWAGEN | Golf Syncro          | 93    | 98    | ✓ |
| VOLKSWAGEN | Golf Variant         | 92    | 99    | ✓ |
| VOLKSWAGEN | Jetta                | 88    | 92    | ✓ |
| VOLKSWAGEN | Jetta Syncro         | 88    | 91    | ✓ |
| VOLKSWAGEN | Passat               | 04/88 | 02/92 | ✓ |
| VOLKSWAGEN | Passat               | 03/92 | 97    | ✓ |
| VOLKSWAGEN | Passat Syncro 2.0    | 89    | 93    | ✓ |
| VOLKSWAGEN | Passat Syncro 2.0    | 94    | 05/97 | ✓ |
| VOLKSWAGEN | Polo Classic/Variant | 96    | 01    | ✓ |
| VOLKSWAGEN | Vento                | 92    | 98    | ✓ |

**04-P111**

|            |                                |       |    |   |
|------------|--------------------------------|-------|----|---|
| SEAT       | Toledo 2.0 16V                 | 92    | 99 | ✓ |
| VOLKSWAGEN | Corrado 2.9 VR6                | 89    | 95 | ✓ |
| VOLKSWAGEN | Golf III 2.0 GTI, 2.8 VR6      | 92    | 97 | ✓ |
| VOLKSWAGEN | Golf Syncro 2.9 VR6            | 93    | 98 | ✓ |
| VOLKSWAGEN | Passat 2.0 16V 110 kW, 2.8 VR6 | 03/92 | 97 | ✓ |
| VOLKSWAGEN | Passat 1.9 TDI 81kW            | 03/92 | 97 | ✓ |
| VOLKSWAGEN | Passat Syncro 2.9 VR6          | 94    | 97 | ✓ |
| VOLKSWAGEN | Vento 2.0 GTI, 2.8 VR6         | 92    | 98 | ✓ |



**04-P135**

|      |        |       |       |   |  |
|------|--------|-------|-------|---|--|
| FORD | Escort | 80    | 08/90 | ✓ |  |
| FORD | Fiesta | 01/87 | 88    | ✓ |  |
| FORD | Orion  | 80    | 08/80 | ✓ |  |

**04-P137**

|      |                           |       |       |   |  |
|------|---------------------------|-------|-------|---|--|
| FORD | Escort V, VI, VII 1.6 4x4 | 07/94 | 01/95 | ✓ |  |
| FORD | Escort 2.0 EFI 16V 4x4    | 01/95 | 09/01 | ✓ |  |
| FORD | Fiesta                    | 89    | 01/94 | ✓ |  |

**04-P139**

|      |                                      |       |       |   |  |
|------|--------------------------------------|-------|-------|---|--|
| FORD | Escort 1.4, 1.6, 1.8, 2.0, 1.8 D     | 09/90 | 01/95 | ✓ |  |
| FORD | Fiesta                               | 01/94 | 08/96 | ✓ |  |
| FORD | Ka                                   | 09/96 | -     | ✓ |  |
| FORD | Orion 1.4, 1.6, 1.8, 2.0, 1.8 Diesel | 09/90 | 01/95 | ✓ |  |
| FORD | Puma                                 | 11/97 | -     | ✓ |  |

**04-P141**

|      |                |       |       |   |  |
|------|----------------|-------|-------|---|--|
| FORD | Cougar 2.0 16V | 08/98 | -     | ✓ |  |
| FORD | Mondeo         | 93    | 11/00 | ✓ |  |

**04-P143**

|      |        |    |   |   |  |
|------|--------|----|---|---|--|
| FORD | Galaxy | 96 | - | ✓ |  |
|------|--------|----|---|---|--|

**04-P145**

|      |                        |    |    |   |  |
|------|------------------------|----|----|---|--|
| OPEL | Ascona C 2.0           | 82 | 88 | ✓ |  |
| OPEL | Ascona C 1.6, 1.8      | 82 | 88 | ✓ |  |
| OPEL | Astra F 1.8            | 92 | 98 | ✓ |  |
| OPEL | Astra F 1.8, 2.0       | 92 | 98 | ✓ |  |
| OPEL | Astra F 1.7            | 92 | 98 | ✓ |  |
| OPEL | Calibra 2.0            | 89 | 97 | ✓ |  |
| OPEL | Kadett E 1.6, 1.8      | 85 | 93 | ✓ |  |
| OPEL | Kadett E 1.6, 1.8, 2.0 | 85 | 93 | ✓ |  |
| OPEL | Kadett E 2.0           | 85 | 93 | ✓ |  |
| OPEL | Vectra A 1.6           | 89 | 95 | ✓ |  |
| OPEL | Vectra A 1.8, 2.0      | 89 | 95 | ✓ |  |
| OPEL | Vectra A 1.7D, 1.7TD   | 89 | 95 | ✓ |  |

**04-P147**

|      |                                 |    |    |   |  |
|------|---------------------------------|----|----|---|--|
| OPEL | Astra F 1.8                     | 92 | 98 | ✓ |  |
| OPEL | Astra F 1.8, 2.0                | 92 | 98 | ✓ |  |
| OPEL | Astra F 1.7                     | 92 | 98 | ✓ |  |
| OPEL | Calibra 2.0                     | 89 | 97 | ✓ |  |
| OPEL | Vectra B 1.6, 2.0, 1.7TD, 2.0TD | 96 | -  | ✓ |  |
| OPEL | Vectra B 1.8                    | 96 | -  | ✓ |  |

**04-P149**

|      |                   |                   |    |    |   |
|------|-------------------|-------------------|----|----|---|
| OPEL | Ascona C 1.3      | 82                | 88 | ✓  |   |
| OPEL | Astra F 1.4, 1.6  | 92                | 98 | ✓  |   |
| OPEL | Corsa             | 83                | 92 | ✓  |   |
| OPEL | Kadett E 1.2, 1.3 | 85                | 93 | ✓  |   |
| OPEL | Kadett E 1.4, 1.6 | 85                | 93 | ✓  |   |
| OPEL | Tigra             | 93                | -  | ✓  |   |
| OPEL | Vectra A 1.4      | 14NV.16SV         | 89 | 95 | ✓ |
| OPEL | Vectra A 1.6      | E16NZ,C16NZ,X16SZ | 89 | 95 | ✓ |
| OPEL | Vectra A 1.6      |                   | 89 | 95 | ✓ |

**04-P151**

|      |                                 |    |    |   |  |
|------|---------------------------------|----|----|---|--|
| OPEL | Calibra 2.5                     | 89 | 97 | ✓ |  |
| OPEL | Vectra B 1.6, 2.0, 1.7TD, 2.0TD | 96 | -  | ✓ |  |
| OPEL | Vectra B 1.8                    | 96 | -  | ✓ |  |
| OPEL | Vectra B 2.0                    | 96 | -  | ✓ |  |
| OPEL | Vectra B 2.0 TD                 | 96 | -  | ✓ |  |

**04-P153**

|      |                      |              |    |   |   |
|------|----------------------|--------------|----|---|---|
| OPEL | Astra F 1.4, 1.6     | 92           | 98 | ✓ |   |
| OPEL | Astra F 1.6, 1.7 TD  | 92           | 98 | ✓ |   |
| OPEL | Astra F 1.7D, 1.7 TD | 92           | 98 | ✓ |   |
| OPEL | Vectra B 1.6         | X16ZR.X16XEL | 96 | - | ✓ |

**04-P155**

|      |       |   |    |   |  |
|------|-------|---|----|---|--|
| SEAT | Arosa | - | 03 | ✓ |  |
|------|-------|---|----|---|--|

**04-P157**

|            |  |     |    |    |   |
|------------|--|-----|----|----|---|
| AUDI       | 100, 100 Avant                         | 91  | 94 | ✓  |   |
| AUDI       | A4, A4 Avant AAH,ABC,AC...,AF...,AL... | 95  | -  | ✓  |   |
| AUDI       | A6, A6 Avant                           | 95  | 01 | ✓  |   |
| AUDI       | A6, A6 Avant                           | AEB | 98 | 01 | ✓ |
| VOLKSWAGEN | Passat ACK,AFN,AGE,AGZ                 | 97  | 00 | ✓  |   |

**04-P159**

|            |                       |    |    |   |  |
|------------|-----------------------|----|----|---|--|
| VOLKSWAGEN | Bora                  | 99 | 02 | ✓ |  |
| VOLKSWAGEN | Bora 4 Motion         | 99 | 02 | ✓ |  |
| VOLKSWAGEN | Bora                  | 99 | 02 | ✓ |  |
| VOLKSWAGEN | Golf/Variant/4 Motion | 98 | 02 | ✓ |  |
| VOLKSWAGEN | New Beetle            | 99 | 02 | ✓ |  |

**04-P161**

|         |                              |       |       |   |  |
|---------|------------------------------|-------|-------|---|--|
| RENAULT | Clio 1.1, 1.2, 1.4           | -     | 03/94 | ✓ |  |
| RENAULT | Clio 1.2, 1.4                | 04/94 | 03/98 | ✓ |  |
| RENAULT | Clio 1.2 Ice, 1.2 RL, 1.2 RN | 04/96 | 03/98 | ✓ |  |
| RENAULT | Clio 1.2                     | 04/98 | -     | ✓ |  |
| RENAULT | Clio 1.8                     | 91    | -     | ✓ |  |
| RENAULT | R 5 super                    | 72    | 85    | ✓ |  |
| RENAULT | R 9                          | 81    | 89    | ✓ |  |
| RENAULT | R 11                         | 83    | 89    | ✓ |  |
| RENAULT | R 19 1.2                     | -     | 05/92 | ✓ |  |
| RENAULT | R 19 Chamade 1.2             | -     | 05/92 | ✓ |  |
| RENAULT | Twingo                       | -     | -     | ✓ |  |

**04-P163**

|         |                                     |       |       |   |  |
|---------|-------------------------------------|-------|-------|---|--|
| RENAULT | Clio 1.8, 1.9                       | -     | 03/94 | ✓ |  |
| RENAULT | Clio 1.4                            | 04/94 | 03/98 | ✓ |  |
| RENAULT | Clio 1.4, 1.6                       | 04/98 | -     | ✓ |  |
| RENAULT | Clio 1.4, 1.8                       | 04/96 | 03/98 | ✓ |  |
| RENAULT | Clio 1.8, 1.9 D                     | 04/94 | 03/98 | ✓ |  |
| RENAULT | Kangoo                              | 98    | -     | ✓ |  |
| RENAULT | Megane 1.4, 1.6                     | 04/99 | -     | ✓ |  |
| RENAULT | Megane 1.4, 1.6, 1.9 D, 1.9 TD      | -     | 03/99 | ✓ |  |
| RENAULT | Megane 2.0 Classic RT, 2.0 Coach RT | -     | 03/99 | ✓ |  |
| RENAULT | R 19 1.4, 1.7, 1.8, 1.9 TD          | -     | 05/92 | ✓ |  |
| RENAULT | R 19 Chamade 1.4, 1.7, 1.8, 1.9 TD  | -     | 05/92 | ✓ |  |
| RENAULT | R 19 1.4, 1.8, 1.9D                 | 06/92 | -     | ✓ |  |
| RENAULT | R 21 1.4, 1.7                       | 89    | 94    | ✓ |  |

**04-P165**

|         |             |    |    |   |  |
|---------|-------------|----|----|---|--|
| RENAULT | Espace      | 84 | -  | ✓ |  |
| RENAULT | R 21 Diesel | 89 | 94 | ✓ |  |
| RENAULT | R 25        | 84 | 93 | ✓ |  |

**04-P167**

|         |                                    |    |       |   |  |
|---------|------------------------------------|----|-------|---|--|
| RENAULT | Laguna                             | 93 | -     | ✓ |  |
| RENAULT | Megane 2.0 Coach RT 16v, 1.9 dt RT | -  | 03/99 | ✓ |  |

**04-P169**

|         |   |       |   |   |  |
|---------|---|-------|---|---|--|
| RENAULT | Megane Scenic 1.6 RXT, 1.6 RXE 1.9, 2.0 | 04/99 | - | ✓ |  |
|---------|---|-------|---|---|--|

**04-P171**

|      |                |    |    |   |   |
|------|----------------|----|----|---|---|
| AUDI | 100, 100 Avant | 77 | 84 | ✓ |   |
| AUDI | 100, 100 Avant | 85 | 86 | ✓ |   |
| AUDI | 100, 100 Avant | 87 | -  | ✓ |   |
| AUDI | 100, 100 Avant | 87 | -  | ✓ |   |
| AUDI | 100, 100 Avant | 88 | 91 | ✓ |   |
| AUDI | 100, 100 Avant | 88 | -  | ✓ |   |
| AUDI | 100, 100 Avant | 88 | -  | ✓ |   |
| AUDI | 80, 90         | 83 | 91 |   | ✓ |
| AUDI | Quattro        | 88 | 91 | ✓ |   |

**04-P173**

|      |        |    |    |   |  |
|------|--------|----|----|---|--|
| AUDI | 80, 90 | 87 | 89 | ✓ |  |
|------|--------|----|----|---|--|

**04-P175**

|      |        |    |    |   |  |
|------|--------|----|----|---|--|
| AUDI | 80, 90 | 87 | 89 | ✓ |  |
| AUDI | 80, 90 | 90 | 91 | ✓ |  |
| AUDI | 80, 90 | 92 | -  | ✓ |  |

**04-P177**

|      |        |    |    |   |  |
|------|--------|----|----|---|--|
| AUDI | 80, 90 | 92 | -  | ✓ |  |
| AUDI | 80, 90 | 93 | 96 | ✓ |  |

**04-P179**

|            |              |                       |    |    |   |  |
|------------|--------------|-----------------------|----|----|---|--|
| AUDI       | A4, A4 Avant | AD...AEB,AF...AH...1Z | 95 | -  | ✓ |  |
| AUDI       | A6, A6 Avant | AEB                   | 98 | 01 | ✓ |  |
| VOLKSWAGEN | Passat       | AD...AEB,AFY,AGZ,AH.. | 97 | 00 | ✓ |  |
| VOLKSWAGEN | Passat       | ALT,ALZ,AVB,AZM       | 01 | 04 | ✓ |  |

**04-P181**

|         |                |    |   |   |  |
|---------|----------------|----|---|---|--|
| CITROËN | Jumper 1800 kg | 89 | - | ✓ |  |
| FIAT    | Ducato         | 89 | - | ✓ |  |
| PEUGEOT | Boxer 1800 kg  | 89 | - | ✓ |  |

**04-P183**

|         |          |          |    |    |   |  |
|---------|----------|----------|----|----|---|--|
| CITROËN | C 25     | serie II | 85 | 89 | ✓ |  |
| FIAT    | Ducato   | serie II | 85 | 89 | ✓ |  |
| FIAT    | Marea    |          | 99 | 02 | ✓ |  |
| FIAT    | Multipla |          | 98 | -  | ✓ |  |
| FIAT    | Punto    |          | 99 | -  | ✓ |  |
| PEUGEOT | J 5      | Serie II | 85 | 89 | ✓ |  |

**04-P185**

|         |               |  |    |   |   |  |
|---------|---------------|--|----|---|---|--|
| CITROËN | C 25          |  | 94 | - | ✓ |  |
| CITROËN | Jumper        |  | 94 | - | ✓ |  |
| FIAT    | Ducato        |  | 94 | - | ✓ |  |
| PEUGEOT | Boxer 1400 kg |  | 94 | - | ✓ |  |

**04-P187**

|         |              |                 |       |       |   |  |
|---------|--------------|-----------------|-------|-------|---|--|
| CITROËN | C 15 Diesel  |                 | 07/86 | 12/97 | ✓ |  |
| CITROËN | C 15 1124ccm |                 | 07/88 | 12/96 | ✓ |  |
| CITROËN | C 15 1360ccm |                 | 05/91 | 12/96 | ✓ |  |
| CITROËN | Saxo         |                 | 05/96 | -     | ✓ |  |
| CITROËN | Visa         |                 | 78    | 91    | ✓ |  |
| CITROËN | ZX 1.4       |                 | 03/91 | 97    | ✓ |  |
| PEUGEOT | 106          | TU32,TU3M,TU3FJ | 91    | -     | ✓ |  |
| PEUGEOT | 205          |                 | 83    | 98    | ✓ |  |
| PEUGEOT | 306          |                 | 93    | -     | ✓ |  |
| PEUGEOT | 309 1.1-1.4  |                 | 85    | -     | ✓ |  |

**04-P189**

|         |              |              |       |       |   |  |
|---------|--------------|--------------|-------|-------|---|--|
| CITROËN | AX           |              | 07/86 | 12/98 | ✓ |  |
| PEUGEOT | 106 1.0, 1.1 | TU9,TU1,TU1M | 91    | -     | ✓ |  |

**04-P191**

|         |                       |  |       |    |   |  |
|---------|-----------------------|--|-------|----|---|--|
| CITROËN | ZX 1.6, 1.7, 1.8, 1.9 |  | 03/91 | 97 | ✓ |  |
| PEUGEOT | 205                   |  | 83    | 98 | ✓ |  |
| PEUGEOT | 306                   |  | 93    | -  | ✓ |  |
| PEUGEOT | 309 1.4-1.9           |  | 85    | -  | ✓ |  |
| PEUGEOT | 405                   |  | 87    | -  | ✓ |  |
| PEUGEOT | 406 I                 |  | 95    | -  | ✓ |  |

**04-P193**

|         |                                      |  |       |    |   |  |
|---------|--------------------------------------|--|-------|----|---|--|
| CITROËN | Evasion                              |  | 06/94 | 02 | ✓ |  |
| FIAT    | Scudo                                |  | 02/96 | -  | ✓ |  |
| FIAT    | Ulysse 1.8, 1.9 TD, 2.0 16v, 2.0 JTD |  | 94    | 02 | ✓ |  |
| LANCIA  | Zeta                                 |  | 98    | 02 | ✓ |  |
| PEUGEOT | 806                                  |  | 94    | -  | ✓ |  |

**04-P195**

|         |                                      |  |       |   |   |  |
|---------|--------------------------------------|--|-------|---|---|--|
| CITROËN | Saxo                                 |  | 05/96 | - | ✓ |  |
| CITROËN | Xsara Break 1.4, 1.6, Coupe 1.4, 1.6 |  | 97    | - | ✓ |  |
| PEUGEOT | 206                                  |  | 98    | - | ✓ |  |

**04-P197**

|            |                           |       |    |    |   |  |
|------------|---------------------------|-------|----|----|---|--|
| ALFA ROMEO | Alfa 145                  |       | 94 | -  | ✓ |  |
| ALFA ROMEO | Alfa 146                  |       | 94 | -  | ✓ |  |
| ALFA ROMEO | Alfa 155 1.9 Turbo Diesel | M1    | 93 | 97 | ✓ |  |
| ALFA ROMEO | Alfa 164 2.0, 2.0 TS      | M1,M2 | 87 | 92 | ✓ |  |

**04-P199**

|      |                      |      |    |    |   |  |
|------|----------------------|------|----|----|---|--|
| OPEL | Astra F 1.4, 1.6     |      | 92 | 98 | ✓ |  |
| OPEL | Astra F 1.7D, 1.7 TD |      | 92 | 98 | ✓ |  |
| OPEL | Vectra A 1.6         | 16SV | 89 | 95 | ✓ |  |

**04-P201**

|            |          |  |    |    |   |   |
|------------|----------|--|----|----|---|---|
| SEAT       | Alhambra |  | 96 | 00 | ✓ |   |
| SEAT       | Alhambra |  | 96 | 00 |   | ✓ |
| VOLKSWAGEN | Sharan   |  | 96 | 00 | ✓ |   |
| VOLKSWAGEN | Sharan   |  | 96 | 00 |   | ✓ |

**04-P203**

|         |     |  |    |    |   |  |
|---------|-----|--|----|----|---|--|
| RENAULT | R 4 |  | -  | -  | ✓ |  |
| RENAULT | R 5 |  | 62 | 93 | ✓ |  |
| RENAULT | R 6 |  | 69 | 87 | ✓ |  |

**04-P205**

|         |         |           |    |   |   |  |
|---------|---------|-----------|----|---|---|--|
| CITROËN | C 25    | serie III | 89 | - | ✓ |  |
| FIAT    | Ducato  | serie III | 89 | - | ✓ |  |
| FIAT    | Talento |           | 89 | - | ✓ |  |
| PEUGEOT | J 5     | Serie III | 89 | - | ✓ |  |

**04-P207**

|         |        |         |   |    |   |  |
|---------|--------|---------|---|----|---|--|
| CITROËN | C 25   | serie I | - | 85 | ✓ |  |
| FIAT    | Ducato | serie I | - | 85 | ✓ |  |
| PEUGEOT | J 5    | Serie I | - | 85 | ✓ |  |

**04-P209**

|            |                |  |    |       |   |  |
|------------|----------------|--|----|-------|---|--|
| ALFA ROMEO | Alfa 33        |  | 88 | 12/89 | ✓ |  |
| ALFA ROMEO | Alfasud Sprint |  | 76 | 89    | ✓ |  |

**04-P211**

|            |        |  |    |   |   |  |
|------------|--------|--|----|---|---|--|
| LADA (VAZ) | Samara |  | 86 | - | ✓ |  |
|------------|--------|--|----|---|---|--|

**04-P213**

|            |      |  |    |   |   |  |
|------------|------|--|----|---|---|--|
| LADA (VAZ) | Niva |  | 76 | - | ✓ |  |
|------------|------|--|----|---|---|--|

**04-P215**

|            |                             |  |       |    |   |  |
|------------|-----------------------------|--|-------|----|---|--|
| ALFA ROMEO | Alfa 33                     |  | 12/89 | -  | ✓ |  |
| ALFA ROMEO | Alfa 33 1.4, 1.7 i.e. 8/16V |  | 91    | 94 | ✓ |  |

**04-P217**

|       |                       |  |   |       |   |  |
|-------|-----------------------|--|---|-------|---|--|
| SKODA | Favorit 115, 135, 136 |  | - | 12/93 | ✓ |  |
| SKODA | Forman                |  | - | 12/93 | ✓ |  |

**VERGLEICHNUMMERNLISTE**
**CROSS REFERENCE GUIDE / LISTE DES ÉQUIVALENCES**
**ALFA ROMEO**

|          |         |
|----------|---------|
| 60501373 | 04-P209 |
| 60559321 | 04-P215 |
| 82390272 | 04-P197 |

**FIAT**

|            |         |
|------------|---------|
| 1300472080 | 04-P185 |
| 1307355080 | 04-P181 |
| 4470075    | 04-P207 |
| 7569715    | 04-P205 |
| 7657422    | 04-P183 |

**FORD**

|         |         |
|---------|---------|
| 1121342 | 04-P143 |
| 1591164 | 04-P135 |
| 3903036 | 04-P139 |
| 6203660 | 04-P137 |
| 7346525 | 04-P141 |

**LADA**

|             |         |
|-------------|---------|
| 21083103012 | 04-P211 |
| 21213103012 | 04-P213 |

**LANCIA**

|            |         |
|------------|---------|
| 1311508080 | 04-P193 |
|------------|---------|

**OPEL**

|          |         |
|----------|---------|
| 90095270 | 04-P145 |
| 90157724 | 04-P149 |
| 90304027 | 04-P199 |
| 90468645 | 04-P153 |
| 90468646 | 04-P147 |
| 90496444 | 04-P151 |

**PSA**

|         |         |
|---------|---------|
| 3307 49 | 04-P187 |
| 3307 62 | 04-P189 |
| 3307 69 | 04-P191 |
| 3307 76 | 04-P195 |

**RENAULT**

|            |         |
|------------|---------|
| 7700415121 | 04-P169 |
| 7700628767 | 04-P203 |
| 7700715149 | 04-P165 |
| 7700719140 | 04-P161 |
| 7700768318 | 04-P163 |
| 7700830220 | 04-P167 |

**VAG**

|               |         |
|---------------|---------|
| 115 407 615 A | 04-P217 |
| 175 407 615   | 04-P103 |
| 1H0 407 613 B | 04-P111 |
| 1J0 407 613 C | 04-P159 |
| 333 501 117   | 04-P002 |
| 333 501 117 A | 04-P006 |

**VAG**

|               |         |
|---------------|---------|
| 333 501 118   | 04-P004 |
| 333 501 118 A | 04-P008 |
| 357 407 613 B | 04-P109 |
| 357 501 117   | 04-P010 |
| 357407615     | 04-P101 |
| 443 407 615A  | 04-P171 |
| 4A0 407 615 D | 04-P157 |
| 6N0 407 613   | 04-P155 |
| 7M0 501 655   | 04-P201 |
| 823 407 615 A | 04-P105 |
| 861 407 615 A | 04-P107 |
| 893 407 615 A | 04-P173 |
| 8A0 407 615   | 04-P175 |
| 8A0 407 615 C | 04-P177 |
| 8D0 407 615 E | 04-P179 |

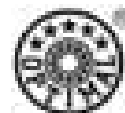

## VERGLEICHSDATENLISTE

### CROSS REFERENCE GUIDE / LISTE DES ÉQUIVALENCES

#### ALFA ROMEO

|         |          |
|---------|----------|
| 04-P197 | 82390272 |
| 04-P209 | 60501373 |
| 04-P215 | 60559321 |

#### FIAT

|         |            |
|---------|------------|
| 04-P181 | 1307355080 |
| 04-P183 | 7657422    |
| 04-P185 | 1300472080 |
| 04-P205 | 7569715    |
| 04-P207 | 4470075    |

#### FORD

|         |         |
|---------|---------|
| 04-P135 | 1591164 |
| 04-P137 | 6203660 |
| 04-P139 | 3903036 |
| 04-P141 | 7346525 |
| 04-P143 | 1121342 |

#### LADA

|         |             |
|---------|-------------|
| 04-P211 | 21083103012 |
| 04-P213 | 21213103012 |

#### LANCIA

|         |            |
|---------|------------|
| 04-P193 | 1311508080 |
|---------|------------|

#### OPEL

|         |          |
|---------|----------|
| 04-P145 | 90095270 |
| 04-P147 | 90468646 |
| 04-P149 | 90157724 |
| 04-P151 | 90496444 |
| 04-P153 | 90468645 |
| 04-P199 | 90304027 |

#### PSA

|         |         |
|---------|---------|
| 04-P187 | 3307 49 |
| 04-P189 | 3307 62 |
| 04-P191 | 3307 69 |
| 04-P195 | 3307 76 |

#### RENAULT

|         |            |
|---------|------------|
| 04-P161 | 7700719140 |
| 04-P163 | 7700768318 |
| 04-P165 | 7700715149 |
| 04-P167 | 7700830220 |
| 04-P169 | 7700415121 |
| 04-P203 | 7700628767 |

#### VAG

|         |               |
|---------|---------------|
| 04-P002 | 333 501 117   |
| 04-P004 | 333 501 118   |
| 04-P006 | 333 501 117 A |
| 04-P008 | 333 501 118 A |
| 04-P010 | 357 501 117   |
| 04-P101 | 357407615     |

#### VAG

|         |               |
|---------|---------------|
| 04-P103 | 175 407 615   |
| 04-P105 | 823 407 615 A |
| 04-P107 | 861 407 615 A |
| 04-P109 | 357 407 613 B |
| 04-P111 | 1H0 407 613 B |
| 04-P155 | 6N0 407 613   |
| 04-P157 | 4A0 407 615 D |
| 04-P159 | 1J0 407 613 C |
| 04-P171 | 443 407 615A  |
| 04-P173 | 893 407 615 A |
| 04-P175 | 8A0 407 615   |
| 04-P177 | 8A0 407 615 C |
| 04-P179 | 8D0 407 615 E |
| 04-P201 | 7M0 501 655   |
| 04-P217 | 115 407 615 A |

**VERGLEICHNUMMERNLISTE**
**CROSS REFERENCE GUIDE / LISTE DES ÉQUIVALENCES**

| <b>RUVILLE</b> | <b>OPTIMAL</b> |
|----------------|----------------|
| 485200         | 04-P135        |
| 485201         | 04-P137        |
| 485202         | 04-P139        |
| 485203         | 04-P141        |
| 485204         | 04-P143        |
| 485301         | 04-P145        |
| 485302         | 04-P147        |
| 485303         | 04-P199        |
| 485304         | 04-P149        |
| 485305         | 04-P151        |
| 485306         | 04-P153        |
| 485401         | 04-P103        |
| 485404         | 04-P101        |
| 485406         | 04-P010        |
| 485407         | 04-P107        |
| 485409         | 04-P155        |
| 485410         | 04-P111        |
| 485412         | 04-P004        |
| 485413         | 04-P002        |
| 485414         | 04-P008        |
| 485415         | 04-P006        |
| 485420         | 04-P109        |
| 485421         | 04-P157        |
| 485422         | 04-P201        |
| 485423         | 04-P159        |
| 485500         | 04-P203        |
| 485501         | 04-P161        |
| 485502         | 04-P163        |
| 485503         | 04-P165        |
| 485510         | 04-P167        |
| 485511         | 04-P169        |
| 485700         | 04-P171        |
| 485701         | 04-P105        |
| 485702         | 04-P173        |
| 485703         | 04-P175        |
| 485704         | 04-P177        |
| 485705         | 04-P179        |
| 485805         | 04-P205        |
| 485806         | 04-P181        |
| 485807         | 04-P207        |
| 485809         | 04-P183        |
| 485810         | 04-P185        |
| 485900         | 04-P187        |
| 485901         | 04-P189        |
| 485902         | 04-P191        |
| 485904         | 04-P193        |
| 485905         | 04-P195        |

|        |         |
|--------|---------|
| 486000 | 04-P209 |
| 486001 | 04-P215 |
| 486002 | 04-P197 |
| 487000 | 04-P211 |
| 487002 | 04-P213 |
| 487801 | 04-P217 |

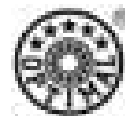

## VERGLEICHNUMMERNLISTE

### CROSS REFERENCE GUIDE / LISTE DES ÉQUIVALENCES

| OPTIMAL | RUVILLE |
|---------|---------|
| 04-P002 | 485413  |
| 04-P004 | 485412  |
| 04-P006 | 485415  |
| 04-P008 | 485414  |
| 04-P010 | 485406  |
| 04-P101 | 485404  |
| 04-P103 | 485401  |
| 04-P105 | 485701  |
| 04-P107 | 485407  |
| 04-P109 | 485420  |
| 04-P111 | 485410  |
| 04-P135 | 485200  |
| 04-P137 | 485201  |
| 04-P139 | 485202  |
| 04-P141 | 485203  |
| 04-P143 | 485204  |
| 04-P145 | 485301  |
| 04-P147 | 485302  |
| 04-P149 | 485304  |
| 04-P151 | 485305  |
| 04-P153 | 485306  |
| 04-P155 | 485409  |
| 04-P157 | 485421  |
| 04-P159 | 485423  |
| 04-P161 | 485501  |
| 04-P163 | 485502  |
| 04-P165 | 485503  |
| 04-P167 | 485510  |
| 04-P169 | 485511  |
| 04-P171 | 485700  |
| 04-P173 | 485702  |
| 04-P175 | 485703  |
| 04-P177 | 485704  |
| 04-P179 | 485705  |
| 04-P181 | 485806  |
| 04-P183 | 485809  |
| 04-P185 | 485810  |
| 04-P187 | 485900  |
| 04-P189 | 485901  |
| 04-P191 | 485902  |
| 04-P193 | 485904  |
| 04-P195 | 485905  |
| 04-P197 | 486002  |
| 04-P199 | 485303  |
| 04-P201 | 485422  |
| 04-P203 | 485500  |
| 04-P205 | 485805  |

| OPTIMAL | RUVILLE |
|---------|---------|
| 04-P207 | 485807  |
| 04-P209 | 486000  |
| 04-P211 | 487000  |
| 04-P213 | 487002  |
| 04-P215 | 486001  |
| 04-P217 | 487801  |







**04-P193****04-P195****04-P197****04-P199****04-P201****04-P205**

**Radlagersätze - Übersicht - Spezialwerkzeuge / Wheel bearing kits - Overview - Special tools / Kits de roulements - Vue d'ensemble - Outils spéciaux**

| OPTIMAL Referenz   | Spezial Werkzeug |                  |
|--|------------------|------------------|
| 100 206, 101 128, 101 209  | <b>WKZ-1099S</b> | <b>WKZ-1089S</b> |
| 100 091, 100 093, 100 098, 101 111, 101 113, 102 041, 131 129, 132 131                   | <b>WKZ-1090S</b> | <b>WKZ-1089S</b> |
| 101 025, 101 027, 101 029, 102 015, 102 069, 102 075, 102 077                            | <b>WKZ-1106S</b> | <b>WKZ-1089S</b> |
| 100 013  | <b>WKZ-1101S</b> | <b>WKZ-1089S</b> |
| 201 032, 201 040, 201 210, 202 026, 202 168, 971 393                                     | <b>WKZ-1108S</b> | <b>WKZ-1092S</b> |
| 301 039, 301 045, 301 132, 301 182, 301 183, 301 511                                     | <b>WKZ-1102S</b> | <b>WKZ-1092S</b> |
| 302 164  | <b>WKZ-1095S</b> | <b>WKZ-1089S</b> |
| 400 061, 400 107, 402 116, 402 159, 601 323, 601 348, 892 468                            | <b>WKZ-1103S</b> | <b>WKZ-1092S</b> |
| 600 308, 600 334, 601 306, 601 336, 602 322, 700 310, 701 346, 701 914, 701 975, 702 765 | <b>WKZ-1105S</b> | <b>WKZ-1092S</b> |
| 501 158, 502 066, 502 068, 502 070, 502 072, 502 109, 502 125, 502 135, 502 138, 502 148 | <b>WKZ-1104S</b> | <b>WKZ-1092S</b> |
| 201 228, 891 630, 891 887, 971 940   | <b>WKZ-1107S</b> | <b>WKZ-1089S</b> |
| 100 022, 100 056, 100 090, 100 091, 101 010, 101 016, 101 024, 101 044                   | <b>WKZ-1088S</b> |                  |

**Radnaben- Übersicht - Spezialwerkzeuge / Wheel hubs - Overview - Special tools / Moyeux de roue - Vue d'ensemble - Outils spéciaux**

| OPTIMAL Referenz   | Spezial Werkzeug |  |
|--|------------------|--|
| 04-P002, 04-P004, 04-P101, 04-P103, 04-P107, 04-P109, 04-P111, 04-P135, 04-P137, 04-P139, 04-P141, 04-P143, 04-P145, 04-P147, 04-P149, 04-P151, 04-P153, 04-P155, 04-P157, 04-P159, 04-P161, 04-P163, 04-P165, 04-P167, 04-P169, 04-P171, 04-P173, 04-P175, 04-P177, 04-P179, 04-P183, 04-P185, 04-P187, 04-P189, 04-P191, 04-P193, 04-P195, 04-P197, 04-P199, 04-P201, 04-P203, 04-P205, 04-P207, 04-P209, 04-P215, 04-P217 | <b>WKZ-1091S</b> |  |

**PRODUKT INFORMATION**

- » Alle Arbeiten werden direkt am Fahrzeug durchgeführt.
- » Alle Werkzeuge ermöglichen eine enorme Zeiteinsparung.
- » Ständige Aktualisierung für neue Fahrzeuge.
- » Keine Probleme bei schwergängigen Lagern und Naben durch Hydraulik.
- » Passend für alle Systeme mit Blocklagern.
- » OPTIMAL-Werkzeuge für Radlager wirken exakt axial.
- » Ergänzung zum Antriebswellenauspressen für alle VW, Audi und alle 4- und 5-Loch-Naben mit Hydraulik-Geräten möglich.
- » Alle mechanischen Werkzeuge sind für Schlagschrauber geeignet, eine Erweiterung ist möglich.
- » Die nachträgliche Achsvermessung entfällt.
- » Mechanische Werkzeuge sind ohne Probleme auf Hydraulik umrüstbar.
- » Individuelle Zusammenstellung für Ihren Bedarf.

**Die Lieferung erfolgt im stabilen Metallkoffer!**

**BESTÜCKUNGSBEISPIEL - UNIVERSELLER EINSATZ**

Passend für: diverse VW, Audi, Opel, Fiat, Honda, Seat und Skoda mit Blocklagern (auch für ABS-Fahrzeuge)

Artikel-Nr.: **WKZ-1088S**

**BESTÜCKUNGSBEISPIEL - UNIVERSELLER EINSATZ**

Passend für: z.B. Audi A-Modelle, Golf IV, Passat

Artikel-Nr.: **WKZ-1089S** Grundeinheit hydr. (ohne Stützbock)

Artikel-Nr.: **WKZ-1090S** Ergänzung für Audi A-Modelle, Passat, Golf IV



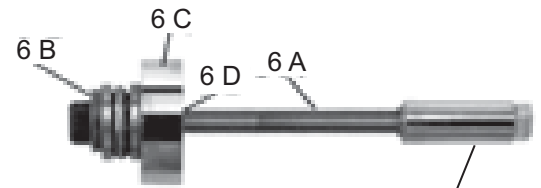
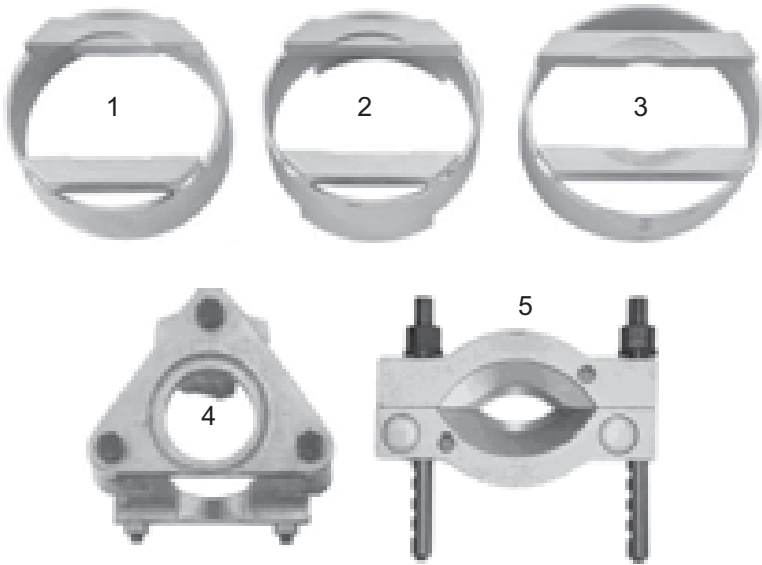

- 6 A -** WKZ-1094 Zugbolzen E-0-201-202  
**6 B -** WKZ-1096 Kugellager E-0-203  
**6 C -** WKZ-1097 Druckstück E-0-204 mech.  
**6 D -** WKZ-1098 Sicherungsring E-0-208

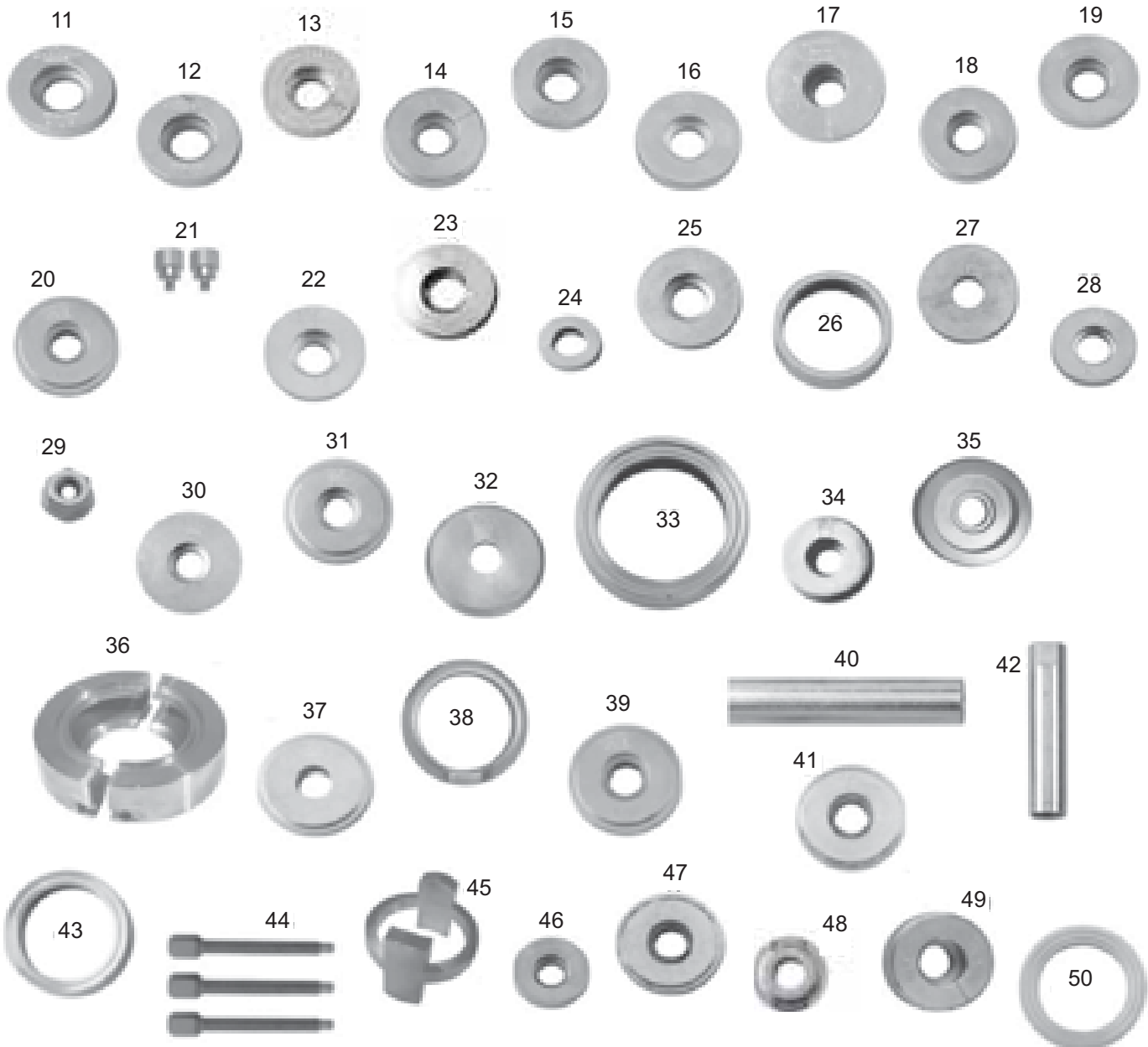
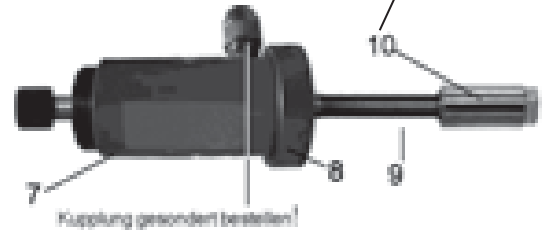

|       |           |   | Hydraulik empfohlen                  |                                       |                    |  |  |                    |                   |                        |                  |   |                             |
|-------|-----------|---|--------------------------------------|---------------------------------------|--------------------|--|--|--------------------|-------------------|------------------------|------------------|---|-----------------------------|
|       |           |   | Grundeinheiten                       |                                       | Ergänzungssätze    |  |  |                    |                   |                        |                  |   |                             |
|       |           |   | WKZ-1092S<br>Grundeinheit mechanisch | WKZ-1089S<br>Grundeinheit hydraulisch | WKZ-1099S<br>VW T4 | WKZ-1100S<br>VW/Audi ohne ABS<br>(Stützbock erforderlich<br>Extra bestellen) | WKZ-1090S<br>A3, A4, A6, A8<br>Passat ab '97 | WKZ-1101S<br>VW T5 | WKZ-1102S<br>Ford | WKZ-1103S<br>DB hinten | WKZ-1104S<br>BMW | WKZ-1105S<br>Peugeot, Renault,<br>Citroen | WKZ-1088S<br>Set mechanisch |
| 01    | WKZ-1001S | Glocke E-40   |                                      |                                       |                    |  | •  |                    | •                 |                        | •                | •   | •                           |
| 02    | WKZ-1002  | Glocke E-41-1 (T)   |                                      |                                       | •                  |  |  |                    |                   |                        |                  |   |                             |
| 03    | WKZ-1003  | Glocke E-55-2   |                                      |                                       |                    |  |  | •                  |                   | •                      | •                |   |                             |
| 04    | WKZ-1004  | Stützbock E-71 / 1-72 /3  |                                      |                                       |                    |  |  |                    |                   |                        |                  |   | •                           |
| 05    | WKZ-1005  | Trenneinheit m. Schnellersp. E-37   |                                      |                                       |                    |  | •  | •                  | •                 | •                      | •                | •   |                             |
| 06    | WKZ-1006  | Zugbolzen komplett mechanisch   | •                                    |                                       |                    |  |  |                    |                   |                        |                  |   | •                           |
| 07    | WKZ-1007  | Hohlkolbenzylinder HKZ-15-1   |                                      | •                                     |                    |  |  |                    |                   |                        |                  |   |                             |
| 08    | WKZ-1008  | Druckstück E-0-204-1, hydr.   |                                      | •                                     |                    |  |  |                    |                   |                        |                  |   |                             |
| 09    | WKZ-1009  | Zugbolzen hydr.   |                                      | •                                     |                    |  |  |                    |                   |                        |                  |   |                             |
| 10    | WKZ-1010  | Spezialmutter E-8-214   | •                                    | •                                     |                    |  |  |                    |                   |                        |                  |   | •                           |
| 11    | WKZ-1011  | Druckstück E-3  |                                      |                                       |                    | •  |  |                    |                   |                        |                  | •   | •                           |
| 12    | WKZ-1012  | Druckstück E-4  |                                      |                                       |                    | •  |  |                    | •                 |                        |                  | •   | •                           |
| 13    | WKZ-1013  | Druckstück E-5  |                                      |                                       |                    | •  | •  |                    | •                 | •                      |                  | •   | •                           |
| 14    | WKZ-1014  | Druckstück E-6-1  |                                      |                                       |                    | •  |  |                    |                   |                        | •                | •   | •                           |
| 15    | WKZ-1015  | Druckstück E-7-1  |                                      |                                       |                    | •  |  |                    |                   |                        | •                | •   | •                           |
| 16    | WKZ-1016  | Druckstück E-9-1  |                                      |                                       |                    |  |  |                    | •                 |                        | •                |   |                             |
| 17    | WKZ-1017  | Druckstück E-10   |                                      |                                       |                    | •  | •  |                    | •                 | •                      |                  | •   | •                           |
| 18    | WKZ-1018  | Druckstück E-12   |                                      |                                       |                    | •  |  |                    | •                 |                        |                  |   | •                           |
| 19    | WKZ-1019  | Druckstück E-13-1   |                                      |                                       |                    | •  | •  |                    |                   |                        | •                | •   | •                           |
| 20    | WKZ-1020  | Druckstück E-14-1   |                                      |                                       |                    | •  | •  |                    |                   | •                      | •                | •   | •                           |
| 21    | WKZ-1021  | Druckschraube E-15 (2x)   |                                      |                                       |                    |  | •  |                    |                   |                        |                  |   |                             |
| 22    | WKZ-1022  | Druckstück E-16 Polo 95/96  |                                      |                                       |                    | •  |  |                    |                   |                        |                  |   | •                           |
| 23    | WKZ-1023  | Druckstück E-17 Polo 95/96  |                                      |                                       |                    | •  |  |                    |                   |                        |                  |   | •                           |
| 24    | WKZ-1024  | Druckstück E-18-1   | •                                    | •                                     |                    |  |  |                    |                   |                        |                  |   |                             |
| 25    | WKZ-1025  | Druckstück E-19 (Skoda)   |                                      |                                       |                    |  |  |                    |                   |                        |                  |   | •                           |
| 26    | WKZ-1026  | Druckhülse E-20-1   |                                      |                                       |                    |  |  |                    |                   |                        |                  | •   |                             |
| 27    | WKZ-1027  | Druckstück E-21 (T)   |                                      |                                       | •                  |  |  |                    |                   |                        |                  |   |                             |
| 28    | WKZ-1028  | Druckstück E-21-1   |                                      |                                       |                    |  |  |                    |                   |                        |                  | •   |                             |
| 29    | WKZ-1029  | Bundmutter M20  |                                      |                                       |                    |  |  | •                  |                   |                        |                  |   |                             |
| 30    | WKZ-1030  | Druckstück E-31   |                                      |                                       | •                  |  |  |                    |                   |                        |                  |   |                             |
| 31    | WKZ-1031  | Druckstück E-42   |                                      |                                       |                    |  | •  |                    |                   |                        |                  |   |                             |
| 32    | WKZ-1032  | Druckstück E-43   |                                      |                                       |                    |  | •  |                    |                   |                        |                  |   |                             |
| 33    | WKZ-1033  | Druckhülse E-44-1   |                                      |                                       |                    |  | •  |                    |                   | •                      |                  |   |                             |
| 34    | WKZ-1034  | Druckstück E-45   |                                      |                                       |                    |  | •  |                    |                   |                        |                  |   |                             |
| 35    | WKZ-1035  | Druckstück E-46 Einbau Radnaben-<br>Radlagereinheit Ø 85 mm T5 vorne + hinten       |                                      |                                       |                    |  |  | •                  |                   |                        |                  |   |                             |
| 36    | WKZ-1036  | Druckscheibe E-47 A/B Einbau Radnaben-<br>Radlagereinheit Ø 85 mm T5 vorne + hinten |                                      |                                       |                    |  |  | •                  |                   |                        |                  |   |                             |
| 37    | WKZ-1037  | Druckstück E-51   |                                      |                                       | •                  |  |  |                    |                   |                        |                  |   |                             |
| 38    | WKZ-1038  | Druckhülse E-54-1   |                                      |                                       |                    |  |  |                    | •                 | •                      |                  | •   |                             |
| 39    | WKZ-1039  | Druckstück E-56   |                                      |                                       |                    |  |  |                    |                   | •                      |                  |   |                             |
| 40    | WKZ-1040  | Druckhülse E-62   |                                      |                                       |                    |  |  |                    |                   |                        | •                |   |                             |
| 41    | WKZ-1041  | Druckstück E-63-1 (auch Sharan)   |                                      |                                       |                    |  |  |                    |                   |                        | •                |   |                             |
| 42    | WKZ-1042  | Spezialmutter E-64-1  |                                      |                                       |                    |  |  |                    |                   |                        | •                |   |                             |
| 43    | WKZ-1043  | Druckhülse E-65-1   |                                      |                                       | •                  |  | •  |                    |                   |                        | •                |   |                             |
| 44    | WKZ-1044  | Druckschraube E-67 (3x)   |                                      |                                       |                    |  |  |                    |                   |                        | •                |   |                             |
| 45    | WKZ-1045  | Druckhülse E-73   |                                      |                                       |                    |  |  |                    |                   |                        |                  | •   |                             |
| 46    | WKZ-1046  | Druckstück E-74   |                                      |                                       |                    |  |  |                    |                   |                        |                  | •   |                             |
| 47    | WKZ-1047  | Druckstück E-75   |                                      |                                       |                    |  |  |                    |                   |                        |                  | •   |                             |
| 48    | WKZ-1048  | Zentrierung + Klammer E-76-2  | •                                    | •                                     |                    |  |  |                    |                   |                        |                  |   | •                           |
| 49    | WKZ-1049  | Druckstück E-77 Lagerausb. Laguna   |                                      |                                       |                    |  |  |                    |                   |                        |                  | •   |                             |
| 50    | WKZ-1050  | Druckring   |                                      |                                       |                    |  |  |                    | •                 |                        |                  | •   |                             |
| o.Abb | WKZ-1093  | Metallkoffer E-600  | •                                    | •                                     | •                  |  | •  | •                  |                   |                        |                  | •   |                             |

einschließlich Lochtafel mit Magnetleisten



RADNABENAUSBAU mechanisch bis Ø 142 mm



- Arbeitsbereich: Radnabenausbau mechanisch
- Passend für: bis Ø 142 mm der Nabe
- Vorteil: Sicheres Ein- und Ausbauen der Nabe.  
- Kein hakeliges Schrauben, sondern ein mittiger Zugbolzen. Komplett im Metallkoffer.
- Gewicht: 11 kg
- Artikel-Nr.: WKZ-1091S
- Artikel-Nr.: WKZ-1001S Glocke E-40. Mit dieser Glocke und der Grundeinheit kann an VW / Audi Fahrzeugen mit ABS die Nabe ausgebaut werden.

|        |          |   | Hydraulik empfohlen                    |   |   |   |                   |   |
|--------|----------|---|--|---|---|---|-------------------|---|
|        |          |   | Ergänzungssätze i. V. mit Grundeinheit |   |   |   |                   |   |
|        |          |   | Einzelwerkzeuge<br>Einzelergänzungen   | WKZ-1109S<br>Antriebswellen<br>auspressen | WKZ-1106S<br>Adapter für die<br>Zukunft (Set) | WKZ-1107S<br>BMW E-39 /<br>Opel Omega B | WKZ-1108S<br>Opel | WKZ-1095S<br>Radlager<br>Ergänzungssatz<br>Ford Transit |
| 50     | WKZ-1051 | Druckstück E-28 Einbau Radnaben-Radlagereinheit Ø 72 mm Audi A2, Skoda Fabia, Polo 9N ab '01  |  |   | •   | (nur Nabenausbau)                       |                   | (Stützbock erforderlich. Extra bestellen)               |
| 51     | WKZ-1052 | Druckscheibe E-29 A/B Einbau Radnaben-Radlager-einheit Ø 72 mm Audi A2, Skoda Fabia, Polo 9N  |  |   | •   |   |                   |   |
| 52     | WKZ-1053 | Druckscheibe E-30 A/B Einbau Radnaben-Radlagereinheit Ø 62 mm VW Lupo 3 Liter ab '99          |  |   | •   |   |                   |   |
| 53     | WKZ-1015 | Druckstück E-7-1 Einbau Radnaben-Radlagereinheit VW Lupo 3 Liter ab '99                       |  |   | •   |   |                   |   |
| 54     | WKZ-1055 | Druckscheibe (geteilt) E-35 Nabenausbau 13" Fahrwerk Seat, VW Polo bis '01                    | •                                      |   |   |   |                   |   |
| 55     | WKZ-1056 | Druckhülse E-36 Lagerausbau 13" Fahrwerk Seat, VW Polo bis '01                                | •                                      |   |   |   |                   |   |
| 56     | WKZ-1057 | Druckscheibe E-27 A/B Einbau Radnaben-Radlagereinheit Ø 66 mm VW Polo 1,2l 01-04 ohne Servok. | •                                      |   |   |   |                   |   |
| 57     | WKZ-1058 | Druckstück E-26 Einbau Radnaben-Radlagereinheit Ø 66 mm VW Polo 1,2l 01-04 o. Servol.         | •                                      |   |   |   |                   |   |
| 58     | WKZ-1059 | Aufpressdorn Einpressen des Wellendichtrings Ford Focus hinten                                | •                                      |   |   |   |                   |   |
| 59     | WKZ-1060 | Spezialmutter E-22 (Fiat)   | •                                      |   |   |   |                   |   |
| 60     | WKZ-1061 | Spezialmutter E-23 (für Radlagereinbau)   | •                                      |   |   |   |                   |   |
| 61     | WKZ-1062 | Druckschraube E-24 f. Skoda Fabia   | •                                      |   |   |   |                   |   |
| 62     | WKZ-1063 | Druckschraube E-38 (Lupo)   | •                                      |   |   |   |                   |   |
| 63     | WKZ-1064 | Druckscheibe E-39 Golf IV + A3 + Q.   | •                                      |   |   |   |                   |   |
| 64     | WKZ-1065 | Druckstück E-95 Einbau Radlager Ford Focus hinten   | •                                      |   |   |   |                   |   |
| 65     | WKZ-1066 | Druckstück E-96 Einbau Radlager Ford Focus hinten   | •                                      |   |   |   |                   |   |
| 66     | WKZ-1029 | Bundmutter M20  |  |   |   |   |                   | •   |
| 67     | WKZ-1068 | Druckbolzen   |  |   |   |   |                   | •   |
| 68     | WKZ-1069 | Lange Mutter  |  |   |   | •                                       |                   | •   |
| 69     | WKZ-1070 | Halbschalen E-69  |  |   |   | •                                       |                   |   |
| 70     | WKZ-1071 | Halbschalen Ausbau Lagerinnenring   | •                                      |   |   |   |                   |   |
| 71     | WKZ-1072 | 5 Lochscheibe Ford Transit Ausbau   |  |   |   |   |                   | •   |
| 72     | WKZ-1073 | Druckstück Ausbau   |  |   |   |   |                   | •   |
| 73     | WKZ-1074 | Bundmutter M10 (5x)   |  |   |   |   |                   | •   |
| 74     | WKZ-1075 | Reduzierung   |  |   |   | •                                       |                   | •   |
| 75     | WKZ-1076 | Klemmschraube (5x)  |  |   |   |   |                   | •   |
| 76     | WKZ-1077 | Glocke E-68   |  |   |   | •                                       |                   |   |
| 77     | WKZ-1078 | Zwischenhülse   |  | •   |   | •                                       |                   | •   |
| 78     | WKZ-1079 | 5-Loch Scheibe  |  | •   |   | •                                       |                   |   |
| 79     | WKZ-1080 | Druckbolzen (5x)  |  |   |   |   |                   | •   |
| 80     | WKZ-1081 | Druckstück E-91   |  |   |   |   | •                 |   |
| 81     | WKZ-1082 | Druckstück Einbau   |  |   |   |   |                   | •   |
| 82     | WKZ-1083 | 4-Loch Scheibe  |  | •   |   |   |                   |   |
| 83     | WKZ-1084 | Spindel mechanisch  |  | •   |   |   |                   |   |
| 84     | WKZ-1085 | Reduzierung mechanisch  |  | •   |   |   |                   |   |
| 85     | WKZ-1086 | Spezialmutter E-92 (i. V. mit E-91)   | •                                      |   |   |   |                   |   |
| 86     | WKZ-1044 | Druckschraube E-67 (5x) Nr. 44 auf Seite F2   |  |   |   | •                                       |                   |   |
| 87     | WKZ-1001 | Glocke E-40 Nr.1 auf Seite F2   |  |   | •   |   |                   |   |
| 88     | WKZ-1012 | Druckstück E-4 Nr.12 auf Seite F2   |  |   |   |   | •                 |   |
| 89     | WKZ-1016 | Druckstück E-9-1 Nr. 16 auf Seite F2  |  |   |   |   | •                 |   |
| 90     | WKZ-1019 | Druckstück E-13-1 Nr. 19 auf Seite F2   |  |   |   |   | •                 |   |
| o.Abb. | WKZ-1093 | Metallkoffer E-600  |  |   | •   | •                                       |                   | •   |

**Werkzeuge für: 301 185, 302 164, 302 257, 302 255 Radlagersätze**

Abziehen der Lagereinheit, nur hydraulisch

Passend für: Ford Transit Scheibenbremsen vorn ab Bj. 2000; Ausbau aus der Achse, Ausbau Bremsscheibe, Lager abziehen und Lager einbauen.

**Artikel-Nr.: WKZ-1095S**

 - Kein Ausbau der Antriebswelle,  
- Kein Lösen von Lenker und Spurstange

 Ergänzung zum Lagerinnenring abziehen  
Artikel-Nr.: WKZ-1071 (i.V.m. Pos. 8, 9, 10, 12)

Hydraulik (12 bis 14) Artikel-Nr.: WKZ-1089S

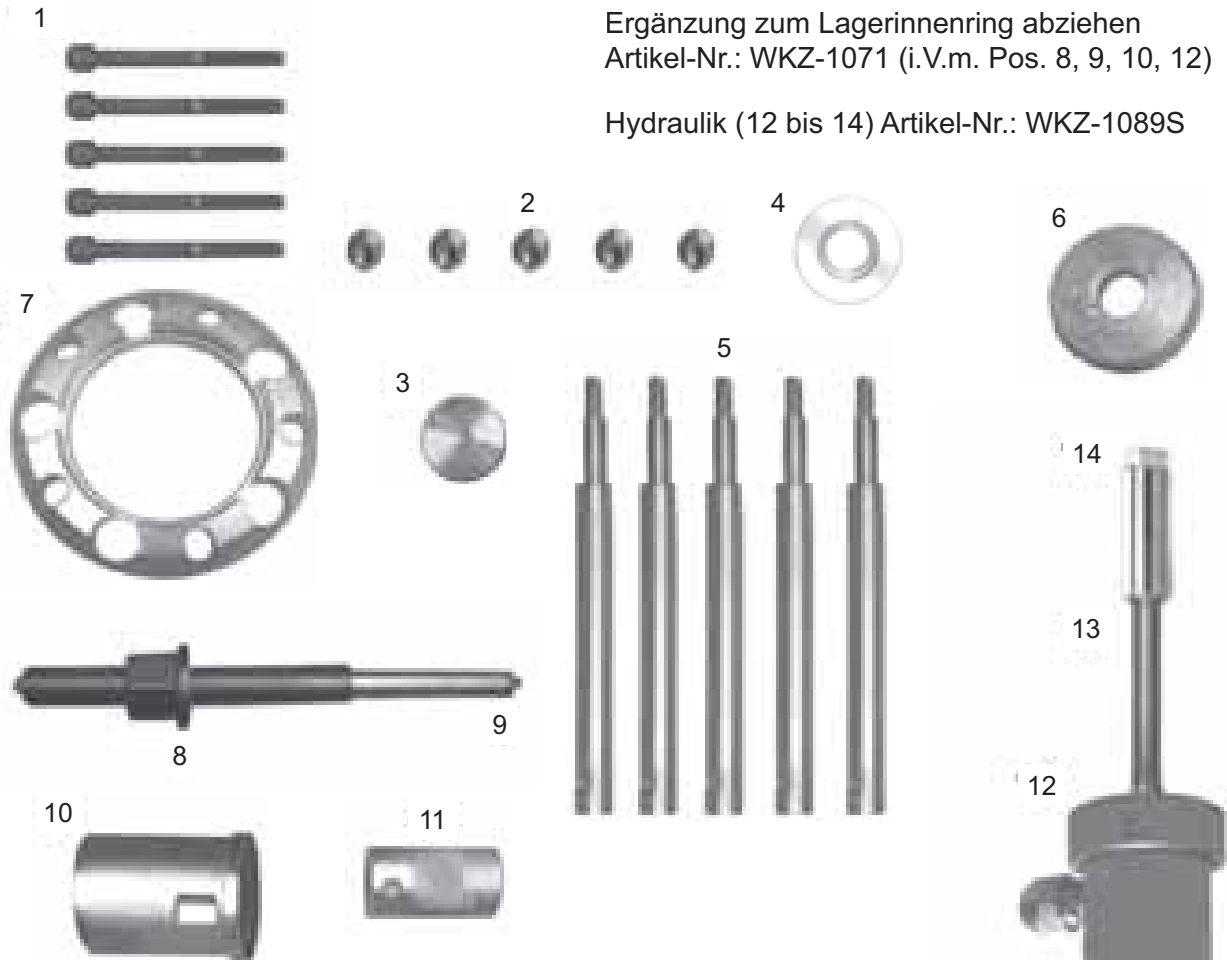
 HKZ 15 mit Zugbolzen  
und Mutter E-8 (nicht im  
Lieferumfang enthalten)

| Position | Artikel-Nr. | Bezeichnung          |
|----------|-------------|----------------------|
| 1        | WKZ-1076    | Klemmschraube        |
| 2        | WKZ-1074    | Bundmutter M10       |
| 3        | WKZ-1073    | Druckstück Ausbau    |
| 4        | WKZ-1082    | Druckstück Einbau    |
| 5        | WKZ-1080    | Druckbolzen          |
| 6        | WKZ-1075    | Reduzierung          |
| 7        | WKZ-1072    | Lochschei 2 x 5-Loch |
| 8        | WKZ-1029    | Bundmutter M20       |
| 9        | WKZ-1068    | Druckbolzen          |
| 10       | WKZ-1078    | Zwischenhülse        |
| 11       | WKZ-1069    | Lange Mutter         |
| 12       | WKZ-1007    | HKZ 15               |
| 13       | WKZ-1094    | Zugbolzen            |
| 14       | WKZ-1010    | Spezialmutter E-8    |

Im Lieferumfang sind Position 1 bis 11 enthalten.  
Position 12 - 14 zusätzlich bestellen. (Artikel-Nr.: WKZ-1089S)

1. Ausbau aus der Achse

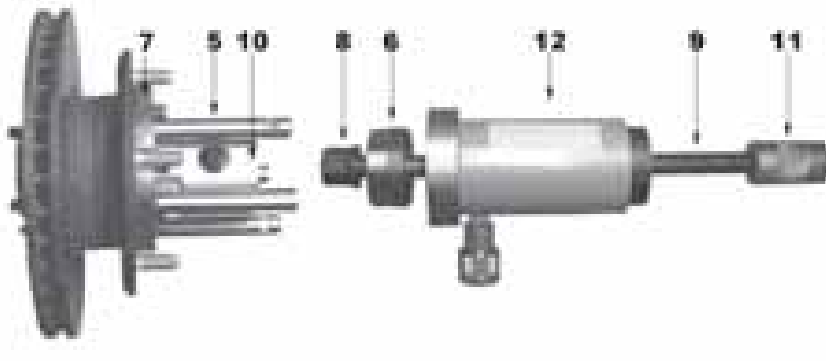

Alle 5 Schrauben und 5 Bolzen müssen verwendet werden. Der Hydraulikzylinder muss bündig auf den Aussparungen (5) aufliegen. Nur so kann die volle Leistung des Hydraulikzylinders wirken.

2. Ausbau der Bremsscheibe

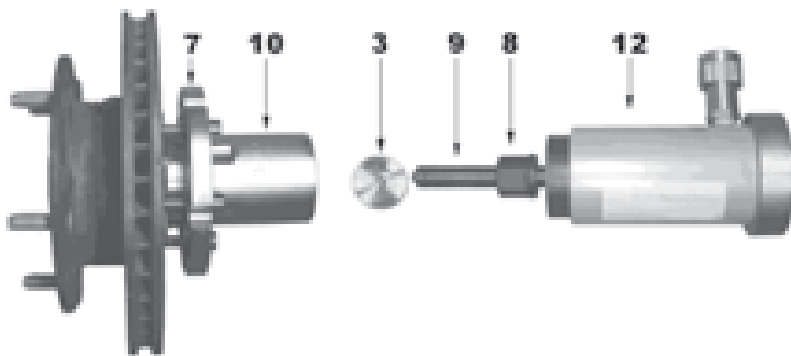

3. Lager abziehen

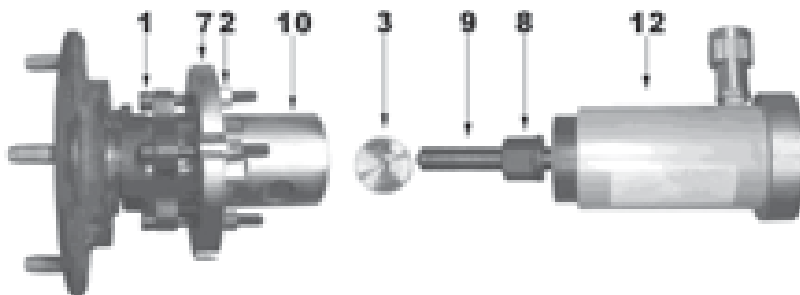

4. Lager einbauen

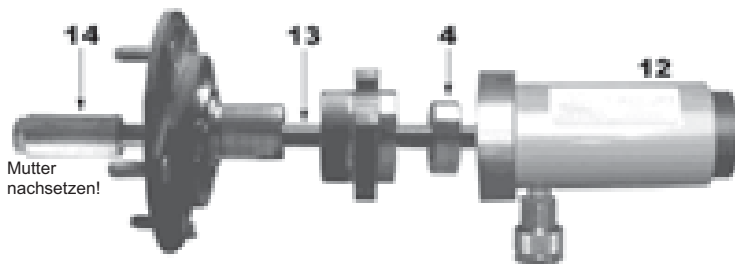

Abziehen vom Lagerinnenring (optional)  
Ergänzung zum Lagerinnenring  
abziehen. Artikel-Nr.: WKZ-1071





**Radlagersätze - Übersicht - Spezialwerkzeuge / Wheel bearing kits - Overview - Special tools / Kits de roulements - Vue d'ensemble - Outils spéciaux**

| OPTIMAL Reference  | Spezial Werkzeug |                  |
|--|------------------|------------------|
| 100 206, 101 128, 101 209  | <b>WKZ-1099S</b> | <b>WKZ-1089S</b> |
| 100 091, 100 093, 100 098, 101 111, 101 113, 102 041, 131 129, 132 131                   | <b>WKZ-1090S</b> | <b>WKZ-1089S</b> |
| 101 025, 101 027, 101 029, 102 015, 102 069, 102 075, 102 077                            | <b>WKZ-1106S</b> | <b>WKZ-1089S</b> |
| 100 013  | <b>WKZ-1101S</b> | <b>WKZ-1089S</b> |
| 201 032, 201 040, 201 210, 202 026, 202 168, 971 393                                     | <b>WKZ-1108S</b> | <b>WKZ-1092S</b> |
| 301 039, 301 045, 301 132, 301 182, 301 183, 301 511                                     | <b>WKZ-1102S</b> | <b>WKZ-1092S</b> |
| 302 164  | <b>WKZ-1095S</b> | <b>WKZ-1089S</b> |
| 400 061, 400 107, 402 116, 402 159, 601 323, 601 348, 892 468                            | <b>WKZ-1103S</b> | <b>WKZ-1092S</b> |
| 600 308, 600 334, 601 306, 601 336, 602 322, 700 310, 701 346, 701 914, 701 975, 702 765 | <b>WKZ-1105S</b> | <b>WKZ-1092S</b> |
| 501 158, 502 066, 502 068, 502 070, 502 072, 502 109, 502 125, 502 135, 502 138, 502 148 | <b>WKZ-1104S</b> | <b>WKZ-1092S</b> |
| 201 228, 891 630, 891 887, 971 940   | <b>WKZ-1107S</b> | <b>WKZ-1089S</b> |
| 100 022, 100 056, 100 090, 100 091, 101 010, 101 016, 101 024, 101 044                   | <b>WKZ-1088S</b> |                  |

**Radnaben- Übersicht – Spezialwerkzeuge / Wheel hubs - Overview - Special tools / Moyeux de roue - Vue d'ensemble - Outils spéciaux**

| OPTIMAL Reference  | Spezial Werkzeug |  |
|--|------------------|--|
| 04-P002, 04-P004, 04-P101, 04-P103, 04-P107, 04-P109, 04-P111, 04-P135, 04-P137, 04-P139, 04-P141, 04-P143, 04-P145, 04-P147, 04-P149, 04-P151, 04-P153, 04-P155, 04-P157, 04-P159, 04-P161, 04-P163, 04-P165, 04-P167, 04-P169, 04-P171, 04-P173, 04-P175, 04-P177, 04-P179, 04-P183, 04-P185, 04-P187, 04-P189, 04-P191, 04-P193, 04-P195, 04-P197, 04-P199, 04-P201, 04-P203, 04-P205, 04-P207, 04-P209, 04-P215, 04-P217 | <b>WKZ-1091S</b> |  |

**PRODUCT INFORMATION**

- » All operations can be carried out directly on the vehicle.
- » All tools make tremendous time savings possible.
- » Tools are continuously updated to new vehicle models.
- » No problems with tight bearings and hubs by use of the hydraulic system.
- » Valid for all block bearings.
- » OPTIMAL tools operate precisely axial.
- » Add-ons for axle drive shafts for all VW, Audi and all 4- and 5-hole hubs, in connection with hydraulics, are possible.
- » All mechanical tools are usable on impact wrenches.
- » Post work axle measuring is not necessary.
- » All mechanical tools can be fitted to hydraulic as well.
- » Individual collection for exact purposes.

**Deliveries are made in stable metal cases!**

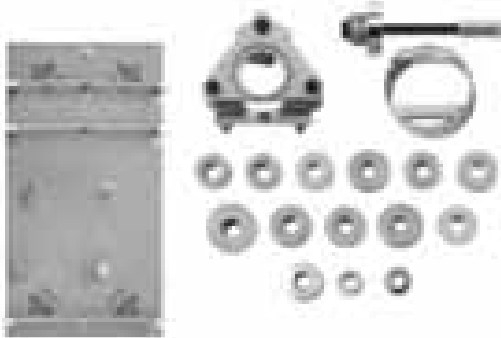
**EXAMPLE OF COLLECTION FOR PRACTICALLY EVERY APPLICATION**

Appropriate for: diverse VW, Audi, Opel, Fiat, Honda, Seat and Skoda with blockbearing (also for ABS-vehicles)

Article-Nr.: **WKZ-1088S**

**EXAMPLE OF COLLECTION FOR VEHICLES WITH FOUR-ROD AXLE STEERING**



Appropriate for: e.g. Audi A-Model, Golf IV, Passat

Article-Nr.: **WKZ-1089S** Basic hydr. (without stand)

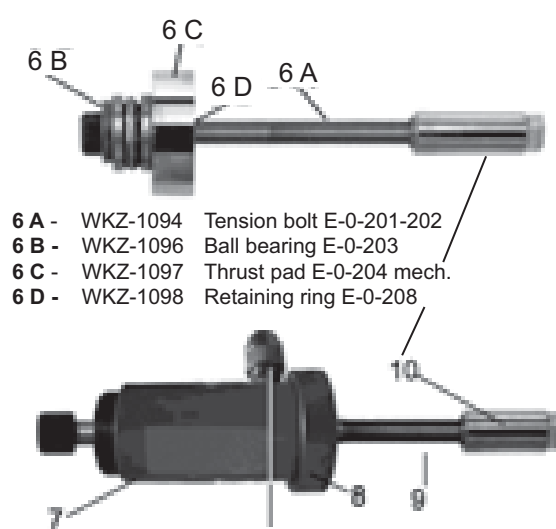
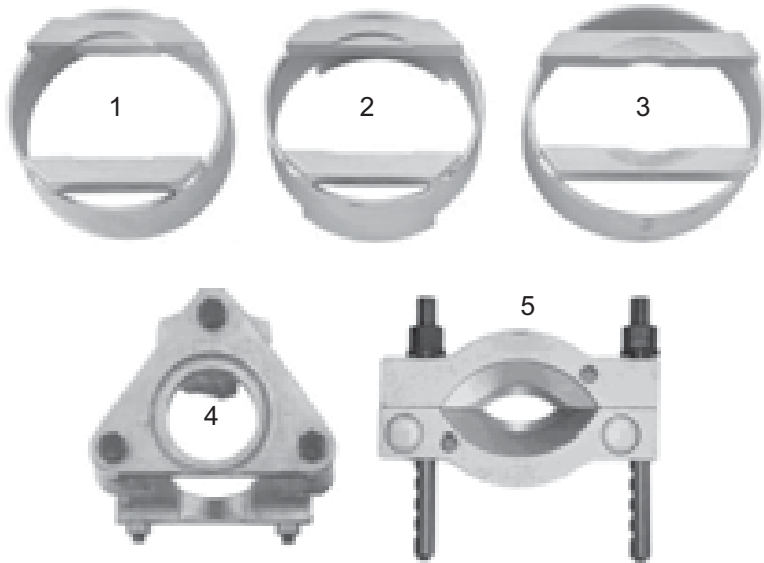
Article-Nr.: **WKZ-1090S** Add-on for Audi A-Model, Passat, Golf IV

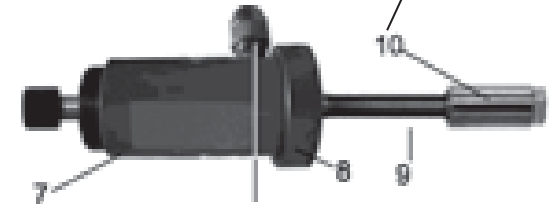

- 6 A - WKZ-1094 Tension bolt E-0-201-202
- 6 B - WKZ-1096 Ball bearing E-0-203
- 6 C - WKZ-1097 Thrust pad E-0-204 mech.
- 6 D - WKZ-1098 Retaining ring E-0-208



Coupling specially ordered!

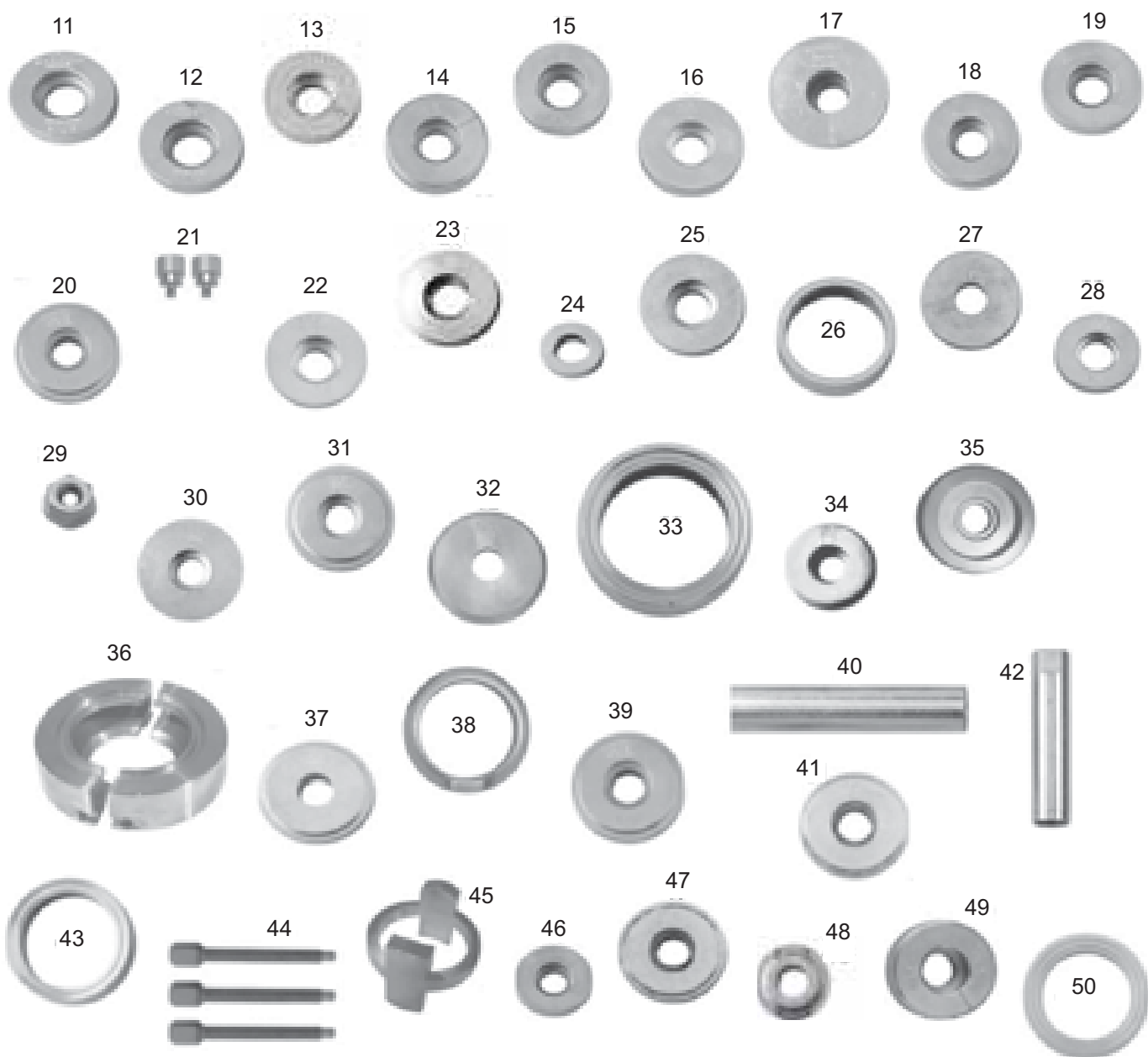



|       |           |  | Hydraulic recommended              |                                   |                    |   |   |                    |                   |                      |                  |   |                             |
|-------|-----------|--|------------------------------------|-----------------------------------|--------------------|---|---|--------------------|-------------------|----------------------|------------------|---|-----------------------------|
|       |           |  | Basic units                        |                                   |                    | Add-on sets   |   |                    |                   |                      |                  |   |                             |
|       |           |  | WKZ-1092S<br>Basic unit mechanical | WKZ-1089S<br>Basic unit hydraulic | WKZ-1099S<br>VW T4 | WKZ-1100S<br>VW/Audi without ABS<br>(Stand necessary,<br>Order separatly) | WKZ-1090S<br>A3, A4, A6, A8<br>Passat '97 | WKZ-1101S<br>VW T5 | WKZ-1102S<br>Ford | WKZ-1103S<br>DB back | WKZ-1104S<br>BMW | WKZ-1105S<br>Peugeot, Renault,<br>Citroën | WKZ-1088S<br>Set mechanical |
| 01    | WKZ-1001S | Cup E-40   |                                    |                                   |                    |   | •   |                    | •                 |                      | •                | •   | •                           |
| 02    | WKZ-1002  | Cup E-41-1 (T)   |                                    |                                   | •                  |   |   |                    |                   |                      |                  |   |                             |
| 03    | WKZ-1003  | Cup E-55-2   |                                    |                                   |                    |   |   | •                  |                   | •                    |                  |   |                             |
| 04    | WKZ-1004  | Stand E-71 / 1-72 /3   |                                    |                                   |                    |   |   |                    |                   |                      |                  |   | •                           |
| 05    | WKZ-1005  | Cut-off-device E-37  |                                    |                                   |                    |   | •   | •                  | •                 | •                    | •                | •   |                             |
| 06    | WKZ-1006  | Tension bolt complet mechanical  | •                                  |                                   |                    |   |   |                    |                   |                      |                  |   | •                           |
| 07    | WKZ-1007  | Hollow piston cylinder HKZ-15-1  |                                    | •                                 |                    |   |   |                    |                   |                      |                  |   |                             |
| 08    | WKZ-1008  | Thrust pad E-0-204-1, hydr.  |                                    | •                                 |                    |   |   |                    |                   |                      |                  |   |                             |
| 09    | WKZ-1009  | Tension bolt hydr.   |                                    | •                                 |                    |   |   |                    |                   |                      |                  |   |                             |
| 10    | WKZ-1010  | Special nut E-8-214  | •                                  | •                                 |                    |   |   |                    |                   |                      |                  |   | •                           |
| 11    | WKZ-1011  | Thrust pad E-3   |                                    |                                   |                    | •   |   |                    |                   |                      |                  | •   | •                           |
| 12    | WKZ-1012  | Thrust pad E-4   |                                    |                                   |                    | •   |   |                    | •                 |                      |                  | •   | •                           |
| 13    | WKZ-1013  | Thrust pad E-5   |                                    |                                   |                    | •   | •   |                    | •                 | •                    |                  | •   | •                           |
| 14    | WKZ-1014  | Thrust pad E-6-1   |                                    |                                   |                    | •   |   |                    |                   |                      | •                | •   | •                           |
| 15    | WKZ-1015  | Thrust pad E-7-1   |                                    |                                   |                    | •   |   |                    |                   |                      |                  | •   | •                           |
| 16    | WKZ-1016  | Thrust pad E-9-1   |                                    |                                   |                    |   |   |                    | •                 |                      | •                |   |                             |
| 17    | WKZ-1017  | Thrust pad E-10  |                                    |                                   |                    | •   | •   |                    | •                 | •                    |                  | •   | •                           |
| 18    | WKZ-1018  | Thrust pad E-12  |                                    |                                   |                    | •   |   |                    | •                 |                      |                  |   | •                           |
| 19    | WKZ-1019  | Thrust pad E-13-1  |                                    |                                   |                    | •   | •   |                    |                   |                      | •                | •   | •                           |
| 20    | WKZ-1020  | Thrust pad E-14-1  |                                    |                                   |                    | •   | •   |                    |                   | •                    | •                | •   | •                           |
| 21    | WKZ-1021  | Adapter E-15 (2x)  |                                    |                                   |                    |   | •   |                    |                   |                      |                  |   |                             |
| 22    | WKZ-1022  | Thrust pad E-16 Polo 95/96   |                                    |                                   |                    | •   |   |                    |                   |                      |                  |   | •                           |
| 23    | WKZ-1023  | Thrust pad E-17 Polo 95/96   |                                    |                                   |                    | •   |   |                    |                   |                      |                  |   | •                           |
| 24    | WKZ-1024  | Thrust pad E-18-1  | •                                  | •                                 |                    |   |   |                    |                   |                      |                  |   |                             |
| 25    | WKZ-1025  | Thrust pad E-19 (Skoda)  |                                    |                                   |                    |   |   |                    |                   |                      |                  |   | •                           |
| 26    | WKZ-1026  | Pressure case E-20-1   |                                    |                                   |                    |   |   |                    |                   |                      |                  | •   |                             |
| 27    | WKZ-1027  | Thrust pad E-21 (T)  |                                    |                                   | •                  |   |   |                    |                   |                      |                  |   |                             |
| 28    | WKZ-1028  | Thrust pad E-21-1  |                                    |                                   |                    |   |   |                    |                   |                      |                  | •   |                             |
| 29    | WKZ-1029  | Collar nut M20   |                                    |                                   |                    |   |   | •                  |                   |                      |                  |   |                             |
| 30    | WKZ-1030  | Thrust pad E-31  |                                    |                                   | •                  |   |   |                    |                   |                      |                  |   |                             |
| 31    | WKZ-1031  | Thrust pad E-42  |                                    |                                   |                    |   | •   |                    |                   |                      |                  |   |                             |
| 32    | WKZ-1032  | Thrust pad E-43  |                                    |                                   |                    |   | •   |                    |                   |                      |                  |   |                             |
| 33    | WKZ-1033  | Pressure case E-44-1   |                                    |                                   |                    |   | •   |                    |                   | •                    |                  |   |                             |
| 34    | WKZ-1034  | Thrust pad E-45  |                                    |                                   |                    |   | •   |                    |                   |                      |                  |   |                             |
| 35    | WKZ-1035  | Thrust pad E-46 Install wheel<br>hub-bearing unit Ø 85 mm T5 front + back        |                                    |                                   |                    |   |   | •                  |                   |                      |                  |   |                             |
| 36    | WKZ-1036  | Pressure disk E-47 A/B Install wheel<br>hub-bearing unit Ø 85 mm T5 front + back |                                    |                                   |                    |   |   | •                  |                   |                      |                  |   |                             |
| 37    | WKZ-1037  | Thrust pad E-51  |                                    |                                   | •                  |   |   |                    |                   |                      |                  |   |                             |
| 38    | WKZ-1038  | Pressure case E-54-1   |                                    |                                   |                    |   |   |                    | •                 | •                    |                  | •   |                             |
| 39    | WKZ-1039  | Thrust pad E-56  |                                    |                                   |                    |   |   |                    |                   | •                    |                  |   |                             |
| 40    | WKZ-1040  | Pressure case E-62   |                                    |                                   |                    |   |   |                    |                   |                      | •                |   |                             |
| 41    | WKZ-1041  | Thrust pad E-63-1 (also Sharan)  |                                    |                                   |                    |   |   |                    |                   |                      | •                | •   |                             |
| 42    | WKZ-1042  | Special nut E-64-1   |                                    |                                   |                    |   |   |                    |                   |                      | •                |   |                             |
| 43    | WKZ-1043  | Pressure case E-65-1   |                                    |                                   | •                  |   | •   |                    |                   |                      | •                |   |                             |
| 44    | WKZ-1044  | Adapter E-67 (3x)  |                                    |                                   |                    |   |   |                    |                   |                      | •                |   |                             |
| 45    | WKZ-1045  | Pressure case E-73   |                                    |                                   |                    |   |   |                    |                   |                      |                  | •   |                             |
| 46    | WKZ-1046  | Thrust pad E-74  |                                    |                                   |                    |   |   |                    |                   |                      |                  | •   |                             |
| 47    | WKZ-1047  | Thrust pad E-75  |                                    |                                   |                    |   |   |                    |                   |                      |                  | •   |                             |
| 48    | WKZ-1048  | Centering + clip E-76-2  | •                                  | •                                 |                    |   |   |                    |                   |                      |                  |   | •                           |
| 49    | WKZ-1049  | Thrust pad E-77  |                                    |                                   |                    |   |   |                    |                   |                      |                  | •   |                             |
| 50    | WKZ-1050  | Pressure ring  |                                    |                                   |                    |   |   |                    | •                 |                      |                  | •   |                             |
| o.Abb | WKZ-1093  | Metall case E-600  | •                                  | •                                 | •                  |   | •   | •                  |                   |                      |                  | •   |                             |

including peg board with magnetic tracks

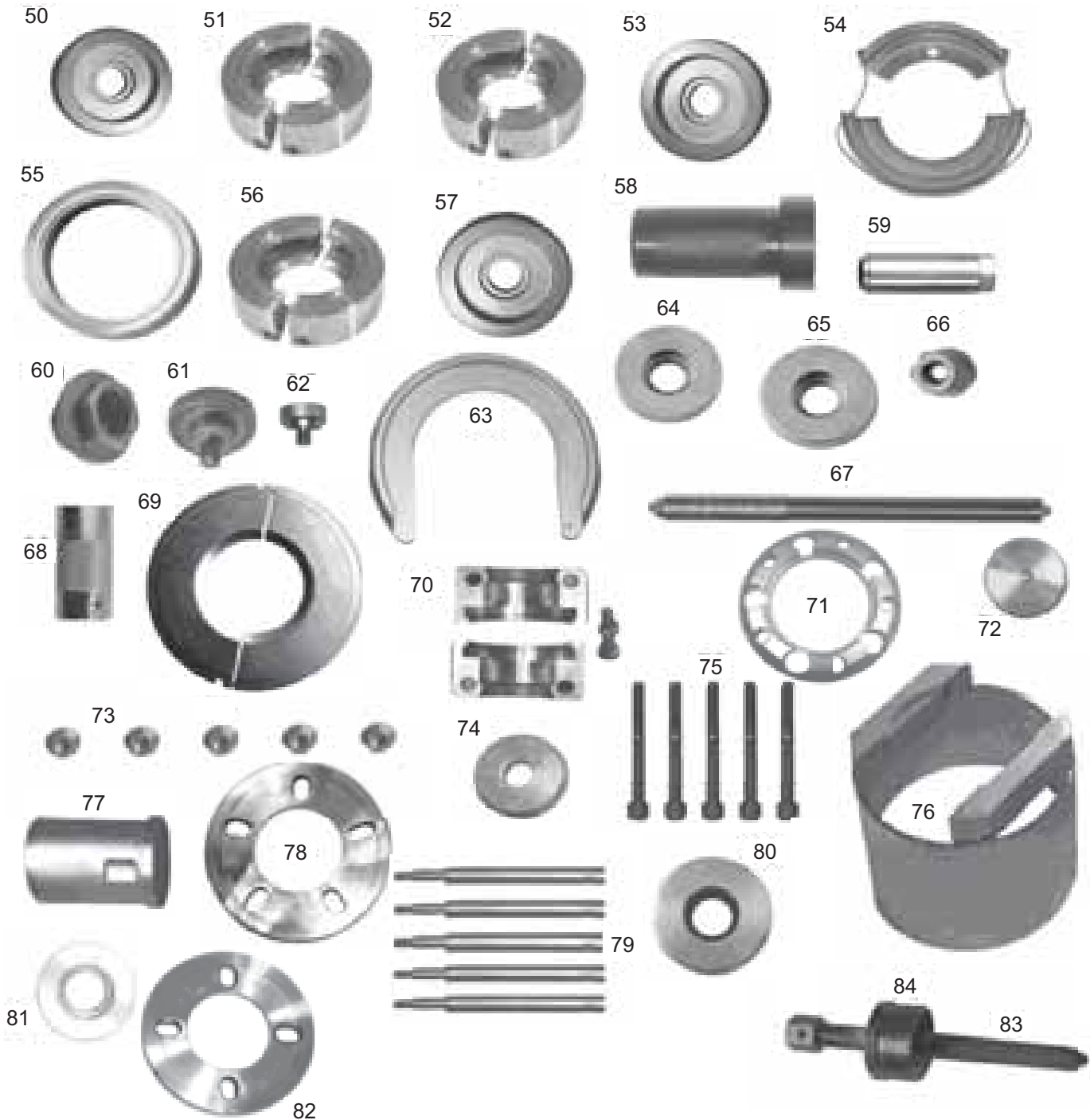

WHEEL HUB REMOVAL mechanical up to Ø 142 mm

Application area: Wheel hub removal mechanically

Appropriate for: up to diameters of Ø 142 mm

Advantage: Secures the installation and removal of wheel bolts in dead center without snagging while screwing. Completely in metal case.

Weight: 11 kg

Article-Nr.: WKZ-1091S

Article-Nr.: WKZ-1001S Cup E-40. With this cup and the basic unit the hubs can be removed on VW / Audi vehicles with ABS .





|        |          |   | Hydraulic recommended                     |                 |  |                                   |                |   |
|--------|----------|---|---|-----------------|--|-----------------------------------|----------------|---|
|        |          |   | Add-on sets in connection with basic unit |                 |  |                                   |                |   |
|        |          |   | Individual tools and add-ons              | Crank shaft set | WKZ-1106S Adapter for the future (Set) | WKZ-1107S BMW E-39 / Opel Omega B | WKZ-1108S Opel | WKZ-1095S Wheel-bearing add-on set for Ford Transit |
| 50     | WKZ-1051 | Thrust pad E-28 Install wheel hub-bearing unit Ø 72 mm Audi A2, Skoda Fabia, Polo 9N '01                |   |                 | •                                      | (Hub removal only)                |                | (Stand necessary, Order seperatly)                  |
| 51     | WKZ-1052 | Pressure disk E-29 A/B Install wheel hub-bearing unit Ø 72 mm Audi A2, Skoda Fabia, Polo 9N             |   |                 | •                                      |                                   |                |   |
| 52     | WKZ-1053 | Pressure disk E-30 A/B Install wheel hub-bearing unit Ø 62 mm VW Lupo 3 Liter '99                       |   |                 | •                                      |                                   |                |   |
| 53     | WKZ-1015 | Thrust pad E-7-1 Install wheel hub-bearing unit VW Lupo 3 Liter '99                                     |   |                 | •                                      |                                   |                |   |
| 54     | WKZ-1055 | Pressure disk (devided) E-35 Hub removal 13" Chassis Seat, VW Polo up to '01                            | •   |                 |  |                                   |                |   |
| 55     | WKZ-1056 | Pressure case E-36 Bearing removal 13" Chassis Seat, VW Polo up to '01                                  | •   |                 |  |                                   |                |   |
| 56     | WKZ-1057 | Pressure disk E-27 A/B Install wheel hub-bearing unit Ø 66 mm VW Polo 1,2l 01-04 without powersteering. | •   |                 |  |                                   |                |   |
| 57     | WKZ-1058 | Thrust pad E-26 Install wheel hub-bearing unit Ø 66 mm VW Polo 1,2l 01-04 without powersteering.        | •   |                 |  |                                   |                |   |
| 58     | WKZ-1059 | Press-out mandrel for shaft sealing ring Ford Focus back  | •   |                 |  |                                   |                |   |
| 59     | WKZ-1060 | Special nut E-22 (Fiat)   | •   |                 |  |                                   |                |   |
| 60     | WKZ-1061 | Special nut E-23 (for wheel bearing installation)   | •   |                 |  |                                   |                |   |
| 61     | WKZ-1062 | Adapter E-24 f. Skoda Fabia   | •   |                 |  |                                   |                |   |
| 62     | WKZ-1063 | Adapter E-38 (Lupo)   | •   |                 |  |                                   |                |   |
| 63     | WKZ-1064 | Pressure disk E-39 Golf IV + A3 + Q.  | •   |                 |  |                                   |                |   |
| 64     | WKZ-1065 | Thrust pad E-95 install wheel bearing Ford Focus back   | •   |                 |  |                                   |                |   |
| 65     | WKZ-1066 | Thrust pad E-96 install wheel bearing Ford Focus back   | •   |                 |  |                                   |                |   |
| 66     | WKZ-1029 | Collar nut M20  |   |                 |  |                                   |                | •   |
| 67     | WKZ-1068 | Pressure bolt   |   |                 |  |                                   |                | •   |
| 68     | WKZ-1069 | Large nut   |   |                 | •                                      |                                   |                | •   |
| 69     | WKZ-1070 | Half shell set E-69   |   |                 | •                                      |                                   |                |   |
| 70     | WKZ-1071 | Half shell set removal inner bearing ring   | •   |                 |  |                                   |                |   |
| 71     | WKZ-1072 | 5-holed disk Ford Transit removal   |   |                 |  |                                   |                | •   |
| 72     | WKZ-1073 | Thrust pad removal  |   |                 |  |                                   |                | •   |
| 73     | WKZ-1074 | Collar nut M10 (5x)   |   |                 |  |                                   |                | •   |
| 74     | WKZ-1075 | Reduction adapter   |   |                 | •                                      |                                   |                | •   |
| 75     | WKZ-1076 | Clamping bolt (5x)  |   |                 |  |                                   |                | •   |
| 76     | WKZ-1077 | Cup E-68  |   |                 | •                                      |                                   |                |   |
| 77     | WKZ-1078 | Bushing   |   | •               |  | •                                 |                | •   |
| 78     | WKZ-1079 | 5-holed disk  |   | •               |  | •                                 |                |   |
| 79     | WKZ-1080 | Pressure bolt (5x)  |   |                 |  |                                   |                | •   |
| 80     | WKZ-1081 | Thrust pad E-91   |   |                 |  |                                   | •              |   |
| 81     | WKZ-1082 | Thrust pad installation   |   |                 |  |                                   |                | •   |
| 82     | WKZ-1083 | 4-holed disk  |   | •               |  |                                   |                |   |
| 83     | WKZ-1084 | Bolt mechanic   |   | •               |  |                                   |                |   |
| 84     | WKZ-1085 | Reduction adapter mechanical  |   | •               |  |                                   |                |   |
| 85     | WKZ-1086 | Special nut E-92 (i. V. mit E-91)   | •   |                 |  |                                   |                |   |
| 86     | WKZ-1044 | Adapter E-67 (5x) Nr. 44 on page 2  |   |                 | •                                      |                                   |                |   |
| 87     | WKZ-1001 | Cup E-40 Nr.1 on page 2   |   |                 | •                                      |                                   |                |   |
| 88     | WKZ-1012 | Thrust pad E-4 Nr.12 on page 2  |   |                 |  |                                   | •              |   |
| 89     | WKZ-1016 | Thrust pad E-9-1 Nr. 16 on page 2   |   |                 |  |                                   | •              |   |
| 90     | WKZ-1019 | Thrust pad E-13-1 Nr. 19 on page 2  |   |                 |  |                                   | •              |   |
| o.Abb. | WKZ-1093 | Metal case E-600  |   |                 | •                                      | •                                 |                | •   |

**Tools Add-on for: 301 185, 302 164, 302 257, 302 255 Bearing kits**

Pulling off the bearing unit, hydraulic.

Appropriate for: Ford Transit disc brake YOC. 2000; onwards. Removal out of the axle,  
Removal of the brake disc, Pulling off and installing the bearing

Article-Nr.: **WKZ-1095S**

- No removal of the crank shaft,
- No loosening of guide and track rod.

Add on to pull off the flat llying bearing rings.  
Article-Nr.: WKZ-1071 (together with: 8, 9, 10, 12)

Hydraulic (12 to 14)  
Article-Nr.: WKZ-1089S

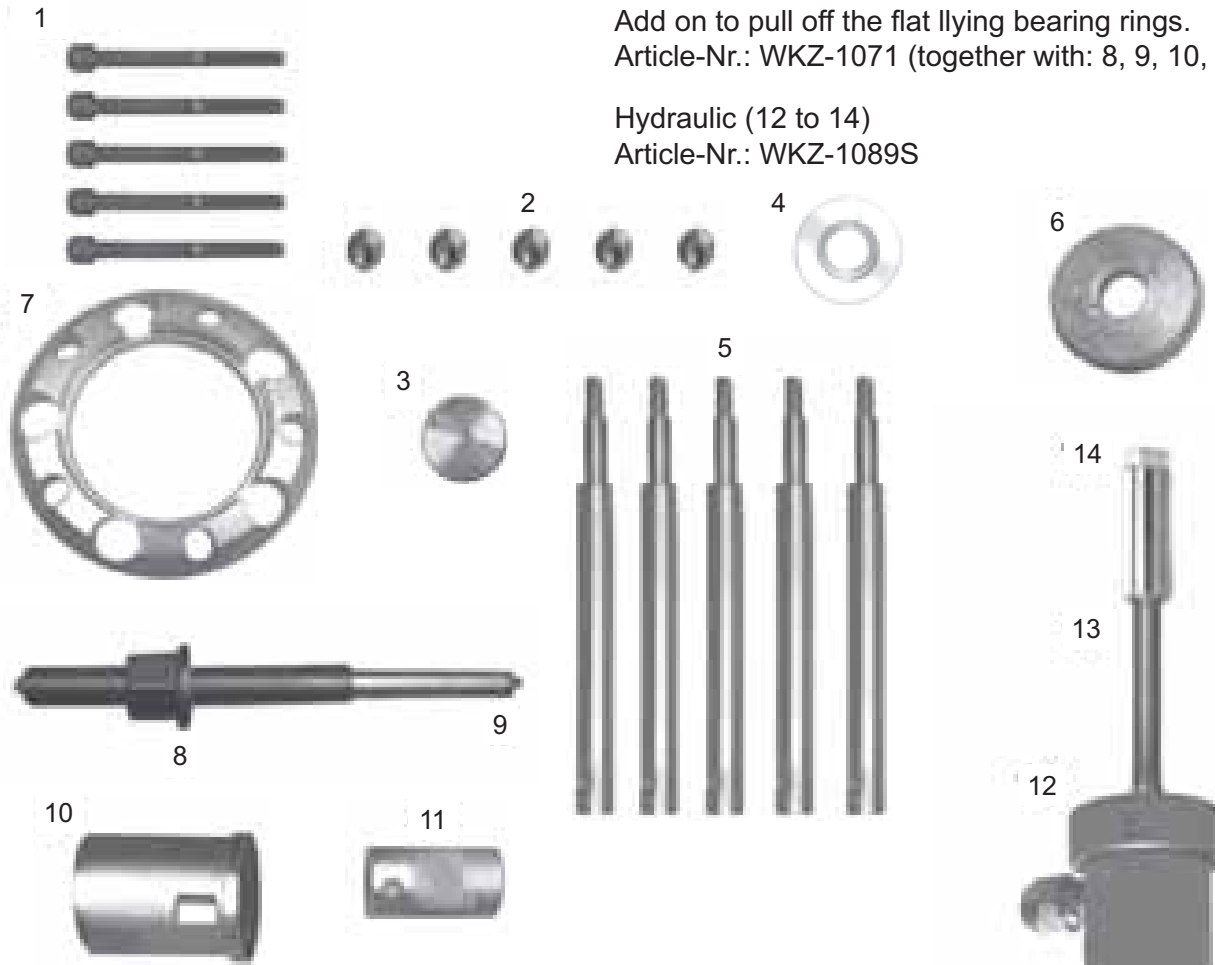

HKZ 15 with tension bolt and special nut E-8 (order seperatly).

| Position | Article-No. | Name                  |
|----------|-------------|-----------------------|
| 1        | WKZ-1076    | Clamping bolt         |
| 2        | WKZ-1074    | Collar nut M10        |
| 3        | WKZ-1073    | Thrust pad removal    |
| 4        | WKZ-1082    | Thrust pad installing |
| 5        | WKZ-1080    | Pressure bolt         |
| 6        | WKZ-1075    | Reducing adapter      |
| 7        | WKZ-1072    | 5-holed disk          |
| 8        | WKZ-1029    | Collar nut M20        |
| 9        | WKZ-1068    | Pressure bolt         |
| 10       | WKZ-1078    | Bushing               |
| 11       | WKZ-1069    | Large nut             |
| 12       | WKZ-1007    | HKZ 15                |
| 13       | WKZ-1094    | Tension bolt          |
| 14       | WKZ-1010    | Special nut E-8       |

In the delivery van range are contracted the position 1 to 11.  
Position 12 - 14 need to be ordered seperatly. (Article-Nr.: WKZ-1089S)

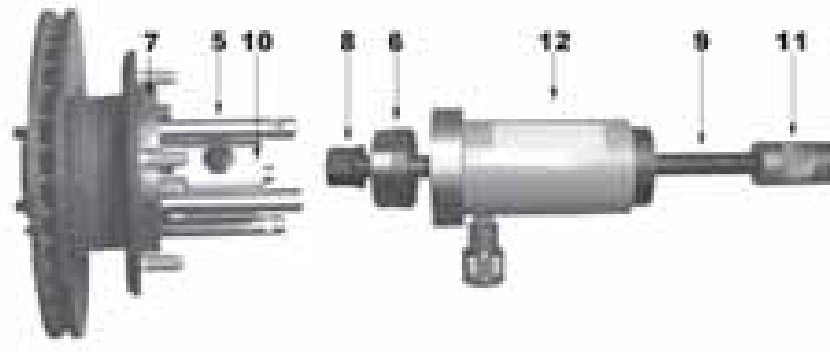
**1. Removal out of the axle**

All 5 clamping bolts and all 5 pressure bolts have to be used. The hollow piston cylinder needs to be flush on the gaps (5). Only then the complete force of the hollow piston cylinder is available.

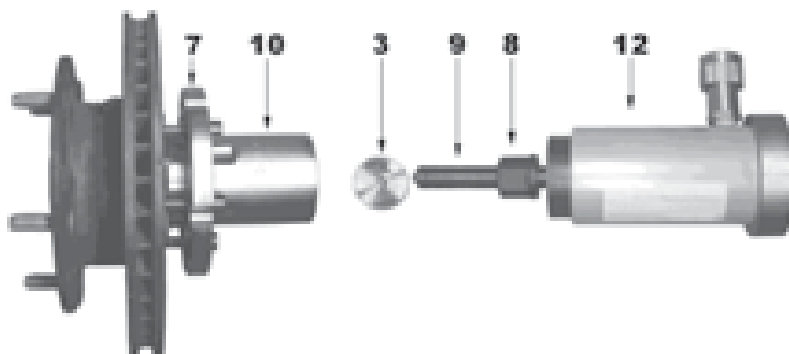
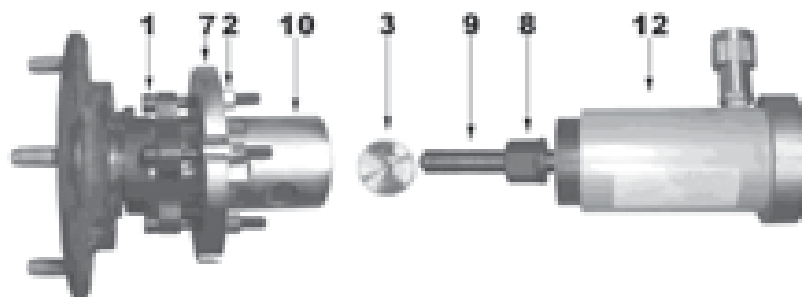
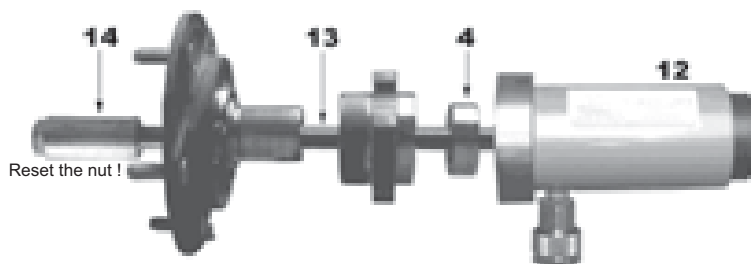
**2. Removal of the brake disc.**

**3. Pulling off the bearing.**

**4. Pulling off the bearing.**

Add-on to pull off the flat llying bearing rings. (optional)  
Article-Nr.: WKZ-1071

