

Application Note 1100

Introduction

LED lamps are available in a wide range of LED materials technologies and package configurations. Selecting the best LED lamp for a given application is based on a number of considerations including the lighting characteristics, compatibility with environmental conditions and intended assembly processes, and price. This guide is intended to familiarize potential automotive customers with the choices available.

One possible flowchart that outlines the LED lamp selection process is shown in Figure 1. The first step is to select the appropriate LED materials technologies based on the desired color. Note that in many cases several materials technologies can be used. The next step is to select the desired LED lamp optical properties, such as luminous intensity and viewing angle based on the lighting application. Then, the optimal LED lamp package can be selected based on the printed circuit board manufacturing process and the worst case reliability test conditions for the targetted application. Following this selection process, prototype lighting evaluation units can be constructed and tested. Finally, a detailed specification can be written that defines the desired electrical and optical test limits.

The different optical terms used in this application note are defined in the glossary in the appendix.

LED Materials Technology

Today, a number of different LED materials technologies are available with which to fabricate the LED chip. These different materials technologies have different electrical and optical properties. The most significant differences to the automotive customer are the color and luminous efficiency of the different materials technologies. A table of commonly available materials technologies is given in Table 1. With the exception of blue LED materials technologies, the electrical properties of the different materials technologies are almost the same. Thus, different LED lamps using these different materials technologies can usually be substituted in the same electrical circuit with minimal changes.

Lighting Considerations

Since the primary goal in using an LED lamp is to provide some type of lighting, then the optical parameters of the lamp should be of utmost importance in selecting the best LED lamp for a given application. Towards this end, the luminous intensity (or luminous flux), viewing angle, dominant wavelength, and uniformity should be key selection parameters. These terms are defined in the Glossary - Optical Terms section at the end of this application note.

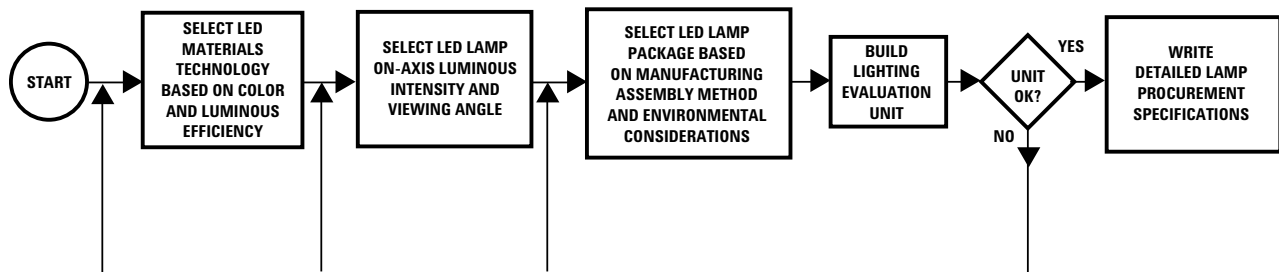

Figure 1. Lamp Selection Process.

Table 1. Luminous efficiency and luminous efficacy of LED materials, ranked by luminous efficiency in a given color range.

Color	Material	Dominant Wavelength (nm)	Luminous Efficiency (lm/W)	Luminous Efficacy (lm/W)
Red	TS AlInGaP	630	15	130
	TS AlGaAs	644	10	85
	AS AlGaAs	637	4	80
	GaAs	648	0.1	65
Reddish-Orange/ Orange	TS AlInGaP	617	20	263
	AS AlInGaP	605	10	370
	AS AlInGaP	615	10	263
	AS AlInGaP	622	8	197
	GaP	626	1	145
	GaP	602	1	380
Amber/Yellow	TS AlInGaP	592	20	480
	AS AlInGaP	590	10	480
	GaP	585	1	500
Green	InGaN	525	15	480
	InGaN	505	10	310
	GaP	569	2	595
	GaP	560	0.7	656
Blue	InGaN	470	2	80
	SiC	481	0.01	130

Figure 2 shows the concept of beam uniformity. Imagine that an LED lamp is mounted behind a piece of diffuser film. The LED lamp will project a round spot of light. The diameter of the spot will be primarily determined by the distance that the LED lamp is mounted behind the diffuser film, and the viewing angle of the lamp. Also, the brightness of the spot will be related to the distance that the LED lamp is mounted behind the diffuser film, and the luminous intensity of the lamp. Uniformity refers to the quality of the projected spot. An ideal LED lamp would project a spot without any secondary defects, like dark spots, or circular concentric rings in the beam. Diffusant can be added to the LED lamp package to provide a very uniform spot. However, some of the luminous flux is wasted because part of the light is scattered at wide off-axis angles. LED lamps with clear lenses are more efficient at directing the light into a useful beam. However, these lamps can have secondary defects in the beam. Thus, it is recommended that samples of the intended LED lamp be evaluated in the final application before making the final LED lamp selection.

The user can also design the backlit graphics to be less susceptible to non-uniformity of the projected spot. Designs where the warning light icon is lit with a surrounding dark background are preferable to a warning light icon with a dark symbol and a surrounding light background, since the beam non-uniformities tend to manifest themselves at the outer edges of the projected spot and the dark background tends to minimize any minor flaws in the lamp radiation pattern.

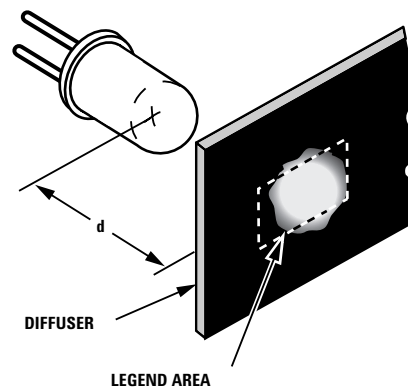

Figure 2. Beam of Light Projected by LED Lamp.

Table 2. Dominant wavelength and color of LED Materials, ranked by dominant wavelength.

Color	Material	Dominant Wavelength (nm)	1931 CIE (x,y) color coordinates
Red	GaAs	648	(0.725, 0.275)
	TS AlGaAs	644	(0.722, 0.278)
	AS AlGaAs	637	(0.716, 0.284)
	TS AlInGaP	630	(0.708, 0.292)
Reddish-Orange	GaP	626	(0.702, 0.298)
	AS AlInGaP	622	(0.695, 0.304)
	TS AlInGaP	617	(0.685, 0.315)
	AS AlInGaP	615	(0.680, 0.320)
Orange	AS AlInGaP	605	(0.648, 0.351)
	GaP	602	(0.636, 0.364)
Amber	TS AlInGaP	592	(0.587, 0.413)
	AS AlInGaP	590	(0.575, 0.424)
Yellow	GaP	585	(0.545, 0.454)
Green	GaP	569	(0.437, 0.562)
	GaP	560	(0.373, 0.624)
	InGaN	525	(0.18, 0.69)
	InGaN	505	(0.10, 0.54)
Blue	SiC	481	(0.15, 0.19)
	InGaN	470	(0.13, 0.08)

Many LED lamp packages have been evaluated as instrument cluster warning lights. For more information, please see the results published in SAE paper 941046, titled "Update: Using LED Lamps for Instrument Cluster Warning Lights." One of the conclusions from the paper is that the viewing angle of the LED lamp should be selected based on the intended instrument cluster cavity depth. For a deep instrument cluster, the optimum LED lamp would have a narrow viewing angle. For a shallow instrument cluster, the optimum LED lamp would have a much wider viewing angle. With a wide viewing angle LED lamp in a deep instrument cluster, the luminous sterance of the legend is not as bright as using the optimum narrow angle LED lamp in the same design. Conversely, using a narrow angle LED lamp in a shallow instrument cluster, the legend may not be properly illuminated in the corners. Obviously, the size of the legend and to a lesser extent the shape of the cavity, will effect the minimum viewing angle needed at a given cavity depth. For a legend size of 14 by 16 mm, and a straight-walled cavity, the optimum viewing angle versus cavity depth is given in Figure 3.

Today's through-hole LED lamps tend to have narrow viewing angles and surface-mount LED lamps tend to have wide viewing angles. Thus, through-hole lamps tend to be more suitable for deep assemblies (≥ 25 mm) while surface-mount lamps tend to be better for shallow assemblies (≤ 25 mm).

The color of a light source is usually defined in terms of an (x, y) coordinate in the 1931 CIE (Commission Internationale de L'Eclairage) chromaticity diagram (color space) or in terms of the dominant wavelength (λ_d). These terms are defined in the glossary at the end of this application note.

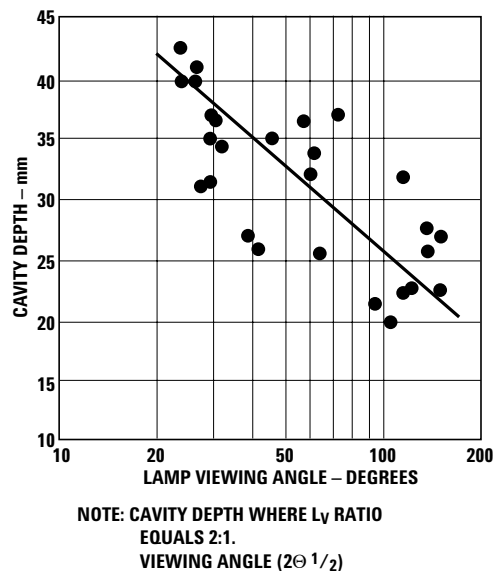

Figure 3. Minimum Viewing Angle vs. Warning Light Cavity Depth.

Since LED lamps have a narrow emission spectrum, they generate a highly saturated colored light. The color of the light is due to the semiconductor p-n junction characteristics of the LED chip within the LED lamp package. For LED lamp colors in the yellow-green through red, the colors of the emitted light are saturated (pure colors) and the 1931 CIE color (x,y) coordinates lie on the extreme right-hand edge of the 1931 CIE color diagram (see Figure 17). For blue LED lamps, the emission spectrum tends to be wider. Furthermore, the blue color is not as saturated, and the 1931 CIE color (x,y) coordinate lies inside the CIE color space away from the locus of dominant wavelength points. A table of the (x,y) color coordinates and dominant wavelengths for commonly available LED lamps is given in Table 2. It is possible to create LED lamps with dominant wavelengths at slightly different values by restricting the color ranges during final product testing. For more information on this option, please consult your local Avago Technologies components field sales engineer.

It is also possible to create other colors by mixing the light from two different LED lamps. For example, mixing the light from a yellow-green LED with a red LED will generate an orange or amber color, depending on the relative brightnesses of the two lamps. However, the resulting color would have the same dominant wavelength and (x,y) coordinate as an orange or amber LED lamp. A blue LED lamp is required to generate colors such as white in the interior of the CIE color space.

It is not recommended that colored filters be used to try to shift the color of LED lamps. Since LED lamps have a narrow spectrum, it is not possible to shift the color significantly without incurring a major reduction in luminous intensity and luminous flux.

LED Lamp Packages

LED lamps are available in a number of different packages, for both through-hole (TH) and surface mount technology (SMT) assembly processes. This section is written to acquaint the user with some of the options available for these different packages. A sketch of the internal construction of a TH LED lamp is shown in Figure 4. The anode and cathode pins are stamped out of a metal sheet. These pins are called the leadframe. A reflector is coined on one pin. The LED die is attached to the base of the reflector, with electrically conducting epoxy. A gold wire is used to connect the metal contact on the top of the LED die to the adjacent pin. A ball bond is formed on top of the LED die and a wedge bond is used to attach the wire to the adjacent pin. Finally, the epoxy package is molded around the leadframe, using either a casting or transfer molding process.

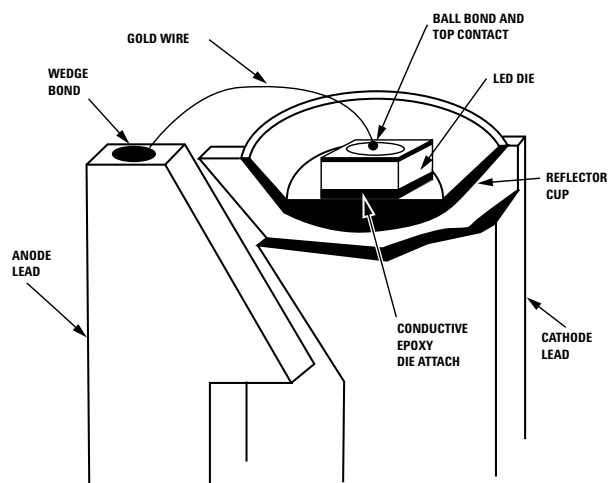

Figure 4. Internal Construction of an LED Lamp.

Many packages are available with different tint, diffusant, and viewing angle options. These terms are defined below:

- **Tint** is a colorant added to the epoxy so that the epoxy has a color when the LED lamp is off. Usually the tint has the same color as the illuminated LED lamp. Tint has minimal effects on the color and luminous flux emitted by the LED die.
- **Diffusant** is a material added to the epoxy that has different optical properties than the epoxy. Light rays that strike a diffusant particle refract at different angles. Thus, diffusant increases the viewing angle of the LED lamp, and lowers the on-axis intensity. Also, the diffusant can reduce the luminous flux generated by the LED lamp.
- **Viewing Angle** refers to the variation in luminous intensity at off-axis angles (see the glossary for further information). The viewing angle of a non-diffused (clear) LED lamp is determined by the shape of the outer package of the LED lamp, the distance between the LED die and the outer package, the shape of the reflector cup, and the radiation pattern of the LED die.

T-1 ³/₄ LED lamp (5 mm package)

This lamp refers to a cylindrical package that is approximately 0.20" (5 mm) in diameter and 0.35" (9 mm) long. The title "T-1 ³/₄" carries over from incandescent bulb nomenclature to specify the number of eighths of an inch to describe the diameter $(1.75)(0.125") = 0.22"$. Usually, a lens is molded in one end of the cylindrical package. The lead-frame pins protrude from the other end of the package. A sketch of this package is shown in Figure 5.

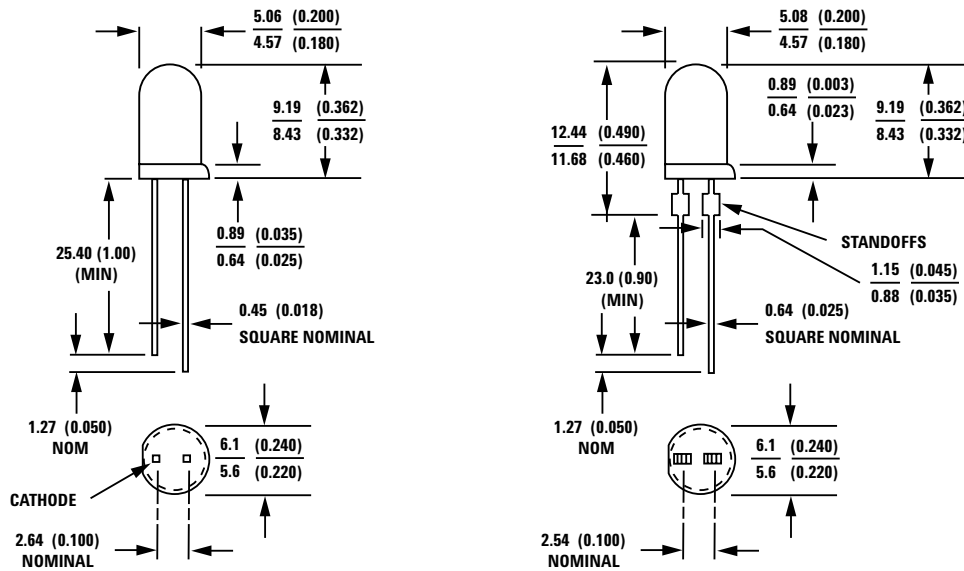

Figure 5. T-1 3/4 LED Lamp Package Outlines.

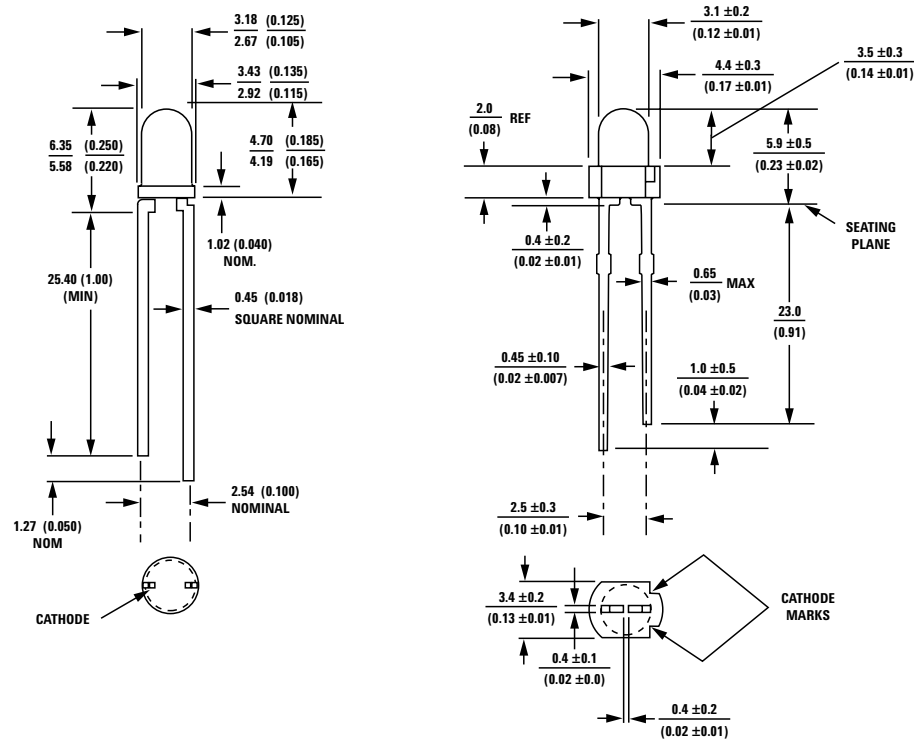

Figure 6. T-1 LED Lamp Package Outlines.

This is the largest LED lamp package offered by Avago Technologies. The large lens and the relatively large distance between the lens and the LED die allows for a more controlled beam of light than the other lamp packages. This LED lamp package offers the highest luminous intensity for a given LED materials technology.

The T-1 ³/₄ package is available in a number of options including:

- tint/no tint.
- diffusant/no diffusant.

- different leadframe thicknesses.
- standoff/no standoff on leads.
- flange/no flange on base of lamp.
- different viewing angles.
- three pin bicolor package.
- trimmed lead lengths (bulk packaging).
- EIA/ANSI RS 468/IEC 268 Tape/ Reel or Ammo Box packaging.

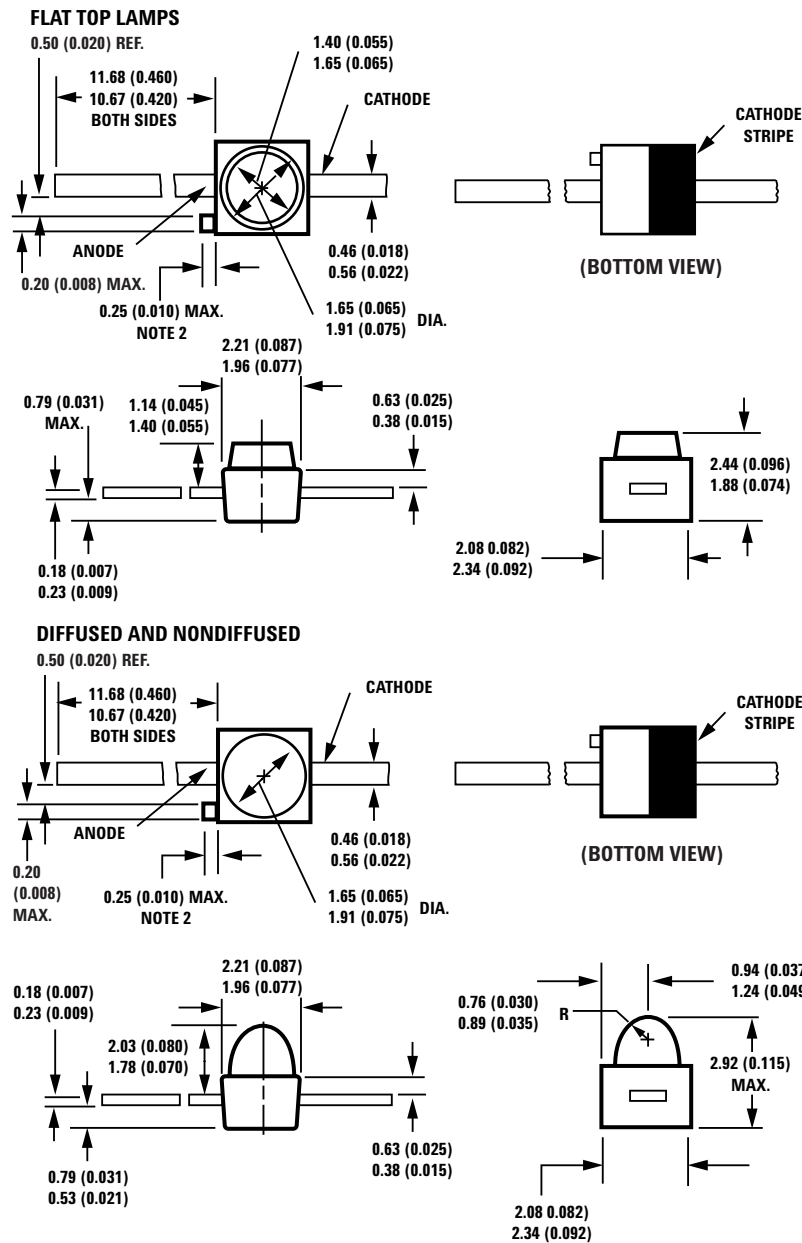

- NOTES:**
 1. ALL DIMENSIONS ARE IN MILLIMETERS (INCHES)
 2. PROTRUDING SUPPORT TAB IS CONNECTED TO CATHODE LEAD.

DEVICE		DESCRIPTION
PACKAGE OUTLINE DRAWING	OPTION NO.	
	11	GULL WING, TAPE AND REEL, 1500 LAMPS PER REEL
	12	GULL WING, BULK PACKAGING
	21	YOKE LEAD, TAPE AND REEL, 1500 LAMPS PER REEL
	22	YOKE LEAD, BULK PACKAGING
	31	Z-BEND, TAPE AND REEL, 1500 LAMPS PER REEL
	32	Z-BEND, BULK PACKAGING

Figure 7. Subminiature LED Lamp Package Outlines.

Table 3. Temperature Dependent Properties of GaP, AlGaAs, and AlInGaP LEDs.

Parameter	Approximate change with Increasing Temperature	Formula (20mA)
I_V	slight decrease	$I_V = I_V(25^\circ\text{C})e^{k\Delta T}$, $K = -0.01$
Viewing Angle	no change	
λ_p, λ_d	slight increase	$\lambda_p = \lambda_p(25^\circ\text{C}) + K\Delta T$, $K = +0.1 \text{ nm}/^\circ\text{C}$
Spectral Width	slight increase	$\lambda^{1/2} = \lambda^{1/2}(25^\circ\text{C})(1 + k\Delta T)$, $K = +0.002 / ^\circ\text{C}$
V_F	slight decrease	$V_F = V_F(25^\circ\text{C}) + k\Delta T$, $K = -1.5 \text{ mV} / ^\circ\text{C}$

T-1 LED lamp (3 mm package)

This lamp refers to a cylindrical package that is approximately 0.125" (3 mm) in diameter and 0.18" (4.5 mm) long. The title "T-1" also carries over from incandescent bulb nomenclature. Usually a lens is molded into one end of the cylindrical package. The leadframe pins protrude from the other end of the package. A sketch of this package is shown in Figure 6.

This small through-hole lamp package has a lower profile than the T-1 3/4 lamp package and provides a wider viewing angle.

The T-1 package is available in a number of options including:

- tint/no tint.
- diffusant/no diffusant.
- different viewing angles.
- trimmed leadlengths (bulk packaging).
- EIA/ANSI RS-468/IEC 268 Tape/Reel or Ammo Box packaging.

Subminiature LED lamp

This lamp is a small, square package with two axial leads and the light being emitted from the top. A lens can be molded into the top of the lamp to create a narrow viewing angle. Alternatively, the dome can be truncated to create a very wide viewing angle. A sketch of this package is shown in Figure 7. This series of lamps is available with several lead bend options for SMT assembly.

The subminiature package is available with a number of options including:

- tint/no tint.
- diffusant/no diffusant.
- different viewing angles.
- lead bends for SMT attachment to top or underside of printed circuit board
- EIA/ANSI RS-481 Tape/Reel packaging.

Environmental Considerations

Automotive applications must operate over a wide range of environmental conditions. LED lamps perform extremely well in vibration and mechanical shock tests because there are no moving parts and the internal bond wire is encapsulated in solid plastic. LED lamps are also designed to operate over a very wide range of temperatures. LED lamps exhibit only minor changes in electrical and optical properties over this range. These changes vary for the different LED materials technologies and LED colors. The approximate variation in electrical and optical properties for LED lamps is summarized in Table 3.

As shown in Figure 4, most LED lamps use a construction technique that uses two metal pins surrounded by epoxy. The LED die is die-attached to one metal pin and connected to the second metal pin by a gold wire. The epoxy expands at a higher rate than the gold wire and pins. Thus, temperature cycling of the LED lamp leads to mechanical stress on the gold wire. Eventually, the gold wire fatigues and breaks. For most epoxies, the temperature coefficient of expansion is constant at low temperatures, and increases at a higher rate at high temperatures. The temperature where the rate of expansion changes is known as glass transition temperature, T_g . Studies have shown that temperature cycling from -40°C to temperatures approaching T_g tend to accelerate this wear out mechanism. For more detail, please see Avago Technologies Application Brief A 04, titled "LED Lamp Thermal Properties". In selecting an LED lamp for automotive applications, the user is recommended to: (a) select lamps with higher maximum junction temperatures, (b) conduct thermal testing to determine the actual maximum junction temperature for the LED lamps used in a new application, and (c) perform power temperature cycle reliability strife tests at these anticipated temperatures. For more detail on thermal testing, please see Avago Technologies Application Brief A 05, titled "LED Lamp Thermal Testing".

The thermal properties of an LED lamp, mounted on a printed circuit board, can be modeled by the following equation:

$$T_J = T_A + P_D (\theta_{J-PIN} + \theta_{PIN-AIR})$$

Where:

T_J = Junction temperature, °C.

T_A = Ambient temperature, °C.

$P_D = I_F V_F W$.

θ_{J-PIN} = lamp thermal resistance junction to pin, °C/W.

$\theta_{PIN-AIR}$ = pcb thermal resistance to free air, °C/W.

The user can reduce the lamp junction temperature with good thermal design practices by reducing the term, $\theta_{PIN-AIR}$. A good thermal design will reduce internal heating, which will reduce the junction temperature and extend the life of the LED lamp in temperature cycle strife tests. For most LED lamps, the LED die is mounted on the top of the cathode pin. Thus, the primary thermal path from the LED die is through the cathode pin to free air. Using a large copper pad for the cathode lead, moving other heat sources (resistors, transistors, incandescent bulbs) away from the LED lamps, and driving the LED lamp at lower currents are ways the user can reduce the temperature rise of the LED lamp. The most common exception to the convention that the LED die

is mounted on the cathode pin is for TS AlGaAs materials technology. The TS AlGaAs LED die is mounted on the anode pin. Thus, the anode lead should be used for heat-sinking of TS AlGaAs LED lamps. For more detail, please see Avago Technologies Application Brief A 04. Using good thermal design practices, most LED lamps are capable of operating at a forward current of 20 mA over the automotive temperature range of -40 °C to +85 °C. Under steady state operation, the light output of any LED lamp reduces slightly with time. This reduction in light output tends to change the most during the initial hours of operation. The rate of light output degradation is generally proportional to drive current. Different LED materials technologies have different rates of light output degradation. Typical light output degradation data is shown in Figure 8. In general, the degradation of light output of an LED lamp compares favorably to that of a non-halogen incandescent bulb.

Avago Technologies LED lamps are subjected to a number of common reliability tests during the development of the product and in ongoing product monitoring processes. These tests and the results for these different LED lamp packages are published in Reliability Data Sheets. In addition, a number of other reliability tests have been conducted. To obtain current Reliability Data Sheets as well as to inquire about other reliability tests, please contact your local Avago Technologies field sales engineer.

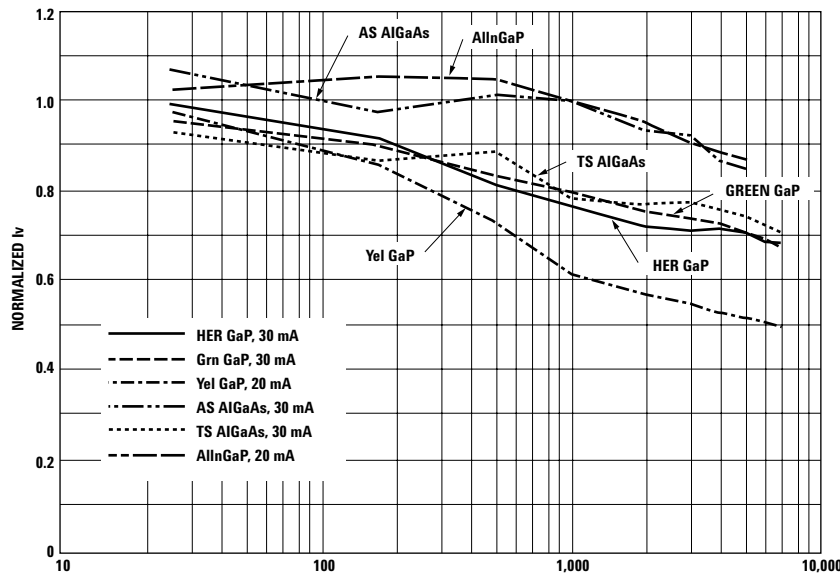
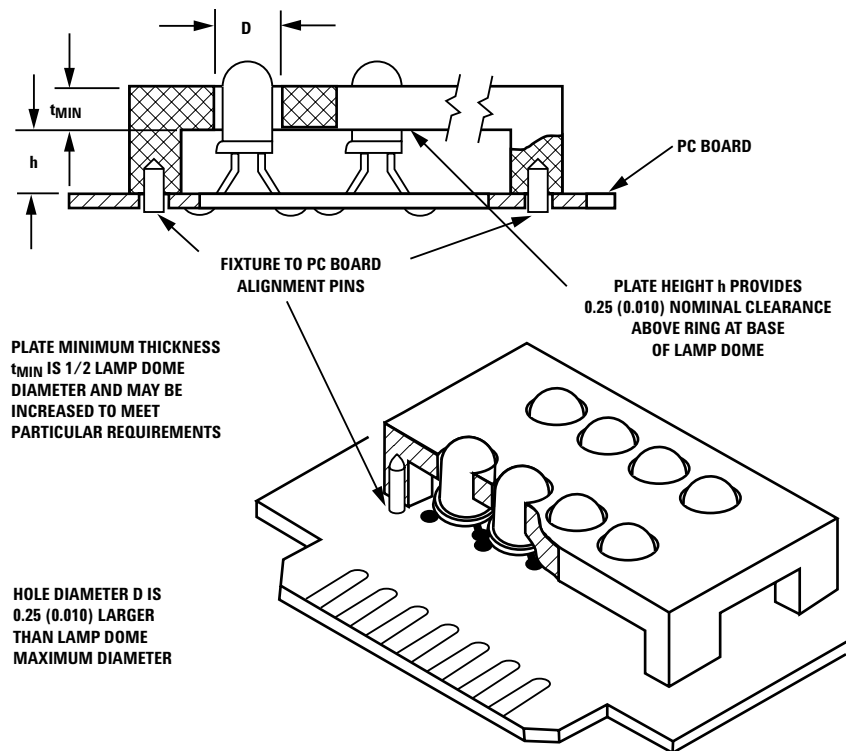

Figure 8. Typical Reduction in Luminous Intensity for Agilent Technologies GaP, AlGaAs, and AlInGaP LEDs.



LAMP TYPE	D-HOLE DIAMETER	t _{MIN} -PLATE THICKNESS	h-PLATE HEIGHT
T-1 3/4	5.33 (0.210)	2.54 (0.100)	5.64 (0.222)
T-1 3/4 LOW PROFILE	5.33 (0.210)	2.54 (0.100)	6.41 (0.252)
T-1	3.43 (0.135)	1.58 (0.062)	5.77 (0.227)
T-1 LOW PROFILE	3.43 (0.135)	1.58 (0.062)	5.77 (0.227)

DIMENSIONS IN MILLIMETERS (INCHES)

Figure 9. Lamp Soldering Fixture.

Through-Hole Lamp High Volume Assembly Considerations

Through-hole LED lamps are available in industry standard EIA/ANSI RS-468 and IEC 268 tape and reel or ammo box packaging. In this format, the lamps are compatible with high-speed radial insertion equipment. The LED lamps are available with the leads formed on 5 mm (0.197 inch) centers or with straight leads on 2.54 mm (0.100 inch) centers. This means that the LED lamps can be mounted on the board at an elevated height (5 mm formed leads), or mounted flush on the board (2.54 mm leads) or mounted at the seating plane determined by the standoffs on the leads (2.54mm leads). For more detail on the radial insertion process, please see Avago Technologies Application Note 1021, titled "Utilizing LED Lamps Packaged on Tape and Reel".

In comparing the T-1 3/4 (5 mm) to the T-1 (3 mm) lamps, the T-1 3/4 lamp can better withstand the rigors of radial automatic insertion. The T-1 lamp has less epoxy surrounding the leadframe and is more susceptible to cracking. Please note that the T-1 lamp is available

in two package outlines (See Figure 6.). The package shown on the right hand side of Figure 6 has a heavier base which increases the package strength for automatic insertion. The use of "soft touch" or lower insertion force radial insertion equipment is recommended for the T-1 lamp family. Also, printed circuit board hole size needs to be controlled tightly in order to prevent missed insertions or epoxy cracking. For more detail on the handling of T-1 lamps for radial insertion, please see Avago Technologies Application Bulletin 74, titled "Option 002 Tape and Reel LED Lamps."

Following automatic insertion, the LED lamps would be subjected to wave soldering. However, unlike most components, the mechanical alignment of the lamp is critical, since the optical beam of light depends on the lamp orientation. If the alignment of the optical beam is critical in the application, the user has several options in which to properly align the LED lamp during wave soldering:

1. Clinch leads.
2. Add a lead bend.
3. Use a removable soldering fixture.
4. Select a flush mount T-1 $\frac{3}{4}$ (5 mm) lamp.

In some applications, especially for wide viewing angle LED lamps, the variation in mechanical alignment during soldering does not cause a noticeable variation in the optical beam emitted by the LED lamp. In these applications, the user does not need to take any special precautions. It is not recommended that the manufacturing operator mechanically bend the lamp to a vertical position after wave soldering unless special precautions are taken to provide strain relief at the base of the LED lamp. Failure to take these precautions may cause the epoxy package to crack where the leads enter the base of the package.

Some automatic insertion equipment allows the user to program the clinch angles and clinch forces. With the proper clinch angle and clinch forces, the variation in mechanical alignment is greatly improved. Setting the best clinch angle and force may require experimentation when the automatic insertion machine is first set-up. Note that many LED lamps are available either in a flush-mount option or with standoffs. The mechanical alignment of the flush-mount LED lamp is determined by the flatness of the bottom of the lamp as well as the clinch angle and clinch forces. For flush mounting, slight imperfections in the lamp epoxy casting process can cause difficulty in soldering.

One imperfection is called excessive epoxy meniscus. Epoxy meniscus is a convex protrusion below the base of the lamp that extends partially down the lead. A small amount of meniscus occurs during the lamp casting process. Excessive meniscus can plug the printed

circuit board hole and cause solder blow holes. The mechanical alignment of the LED lamp with standoffs is determined by the hole size, clinch angle and clinch force. While the LED lamp with standoffs tends to have a larger variation in mechanical alignment, the standoffs provide improved soldering, since the standoffs allow the soldering gases to escape freely.

Flush-mount LED lamps are available with a lead bend that defines the seating plane of the LED lamp. The height of this lead bend can be adjusted and Agilent Technologies offers a number of standard lead bend heights.

Another technique is to use a removable soldering fixture, as shown in Figure 9. The soldering fixture is attached to the board following radial insertion. The soldering fixture has accurately drilled holes that locate the bodies of the LED lamps in a vertical orientation. Following soldering and after the printed circuit board has cooled, the fixture would be removed and reused. For more information on soldering fixtures, please see Avago Technologies Application Note 1021, page 7.

A final technique is to select a T-1 $\frac{3}{4}$ lamp specifically designed for flush mounting. Flush mounting requires that the amount of epoxy meniscus be tightly controlled. An LED lamp that is specifically designed for flush mounting would have a tightly controlled epoxy meniscus. Please consult your Avago Technologies field sales engineer for a current selection of flush mountable T-1 $\frac{3}{4}$ lamps. Proper control of the clinch angle, reducing the clinch force, and optimizing the printed circuit hole diameters provide good control of the mechanical alignment of the lamp as well as good solderability (minimize solder blow holes).

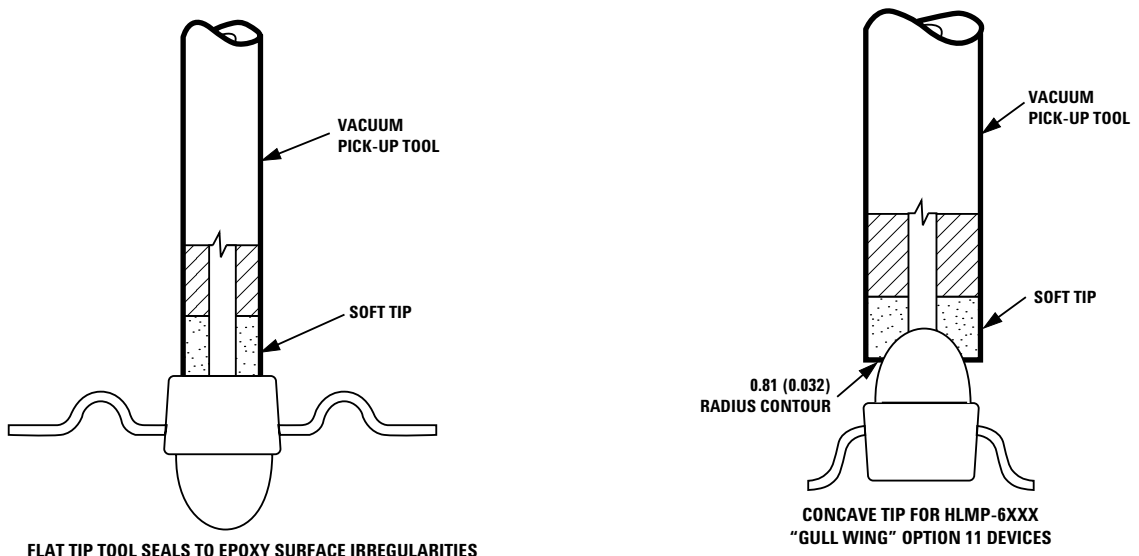

Figure 10. Soft Tip Vacuum Pick-up Tool for Extracting SMT LED Components from Embossed Carrier Tape.

Through-hole LED lamps are normally designed for a pre-heat temperature of 100°C (as measured with a thermocouple attached to the LED pins) prior to immersion in the solder wave with a maximum solder bath temperature of 260°C, and a maximum lead immersion time of 5 seconds (typical wave soldering conditions are 245°C for 3 seconds). These limits are consistent with most single and dual wave soldering machines. For best results, the wave soldering machine should be fixtured such that the underside of the printed circuit board is immersed to the same depth in the solder wave. Fixturing that allows the printed circuit to sag in the center of the board or is not coplanar to the solder bath can cause uneven soldering. Following soldering, excess soldering fluxes can be removed from the printed circuit board using an aqueous cleaning technique, or can be left on the printed circuit board if a “no-clean flux” was used. A number of commonly available solvents can attack the epoxy LED lamp package.

SMT Lamp High Volume Assembly Considerations

A number of SMT LED lamp packages are currently available. These lamps are available in a wide range of mounting configurations and viewing angles. These lamps are available in industry standard EIA Standard 481 8 mm or 12 mm tape and reel packaging. In this format, the lamps are compatible with high-speed pick and place automation insertion equipment. Since SMT LED lamps are fabricated with a casting process, the epoxy package may contain slight surface irregularities. Also, some SMT lamp packages have a convex lens to further improve the optical properties of the lamp. For optimum performance, a custom soft tip vacuum pick-up tool is recommended for the automatic insertion equipment, as shown in Figure 10.

The epoxy materials used for LED lamp packages tend to absorb moisture. In normal operation, this slight moisture absorption does not affect the reliability of the lamp. However, if moisture absorption occurs prior to soldering, then the moisture can rapidly turn into steam during the reflow soldering process. This, in turn, can cause catastrophic failures of the LED lamp. The different SMT LED lamp families utilize different epoxy materials that absorb moisture at different rates. To minimize this potential problem, the reels of SMT lamps are shipped in moisture barrier envelopes. This packaging minimizes any moisture absorption during storage, shipping and handling. It is recommended that the SMT LED lamps be attached to the printed circuit board within two weeks after the moisture barrier envelope is opened.

For best soldering results, the printed circuit board pads should be tailored to the particular SMT LED package. Recommended printed circuit pad layouts are shown in the Product Data Sheets.

SMT LED lamps are compatible with several SMT soldering processes including vapor phase reflow soldering, convective IR reflow soldering, and hot nitrogen reflow soldering. In addition, some of the SMT LED lamp packages are compatible with TTW soldering processes. Please contact your Avago Technologies field sales engineer for additional information.

Building the Lighting Prototype

After the LED lamp has been selected, it is recommended that lighting prototypes be constructed prior to creating the final lighting specification. All Avago Technologies LED lamps are 100% tested in production and binned for luminous intensity. Furthermore, all yellow and green Avago Technologies LED lamps are 100% tested in production and binned for dominant wavelength. The luminous intensity and color bins have been set-up such that lamps from a given bin appear equally bright and the same color to the human eye (red LED lamps are not color binned because these LED lamps in a given package style appear to be the same color to the human eye.)

Avago Technologies’ luminous intensity binning system consists of a series of overlapping bins. A ratio of 2.0:1.0 is used for the maximum and minimum luminous intensity values in a particular bin. Each luminous intensity bin is assigned a letter, ranging from A to Z. Bin A corresponds to the lowest luminous intensity range and bin Z corresponds to the highest luminous intensity range. For a given LED lamp part number, only a few of these bins are populated. Your local Avago Technologies field sales engineer can provide you with further information about the luminous intensity binning system, as well as information about the populated range and most highly populated bin(s) for a given LED lamp part number. For most products, Avago Technologies does not mix LED lamps of different intensity bins inside individual shipping containers (bags, boxes, tubes, or reels).

Avago Technologies’ color binning system consists of a series of overlapping bins with a minimum and maximum dominant wavelength for each particular bin. The width of each color bin varies from 3.5 nm for yellow LED lamps, to 4.0 nm for green LED lamps. Each color bin is assigned a number or letter. For a given LED lamp part number, only some of these color bins are populated. Your local Avago Technologies field sales engineer can provide you with further information about this color binning system, as well as information about the populated range and most highly populated bin(s) for a given LED lamp part number. For most products, Avago Technologies does not mix LED lamps of different color bins inside individual shipping containers (bags, boxes, tubes, or reels).

In order to ensure that the lighting prototypes accurately represent the production capabilities of the LED lamps, individual lamps can be selected from the mean of the production luminous intensity and color distributions. Also, lamps can be selected from the populated luminous intensity and color bins. These different lamps can be assembled into one or more lighting prototypes that reflect the typical light output and anticipated luminous intensity and color ranges. Your local Avago Technologies field sales engineer can provide you with bin-limit LED lamp samples.

Creating the LED Specification

The final step in selecting an LED lamp is to create the final LED specification. All Avago Technologies LED lamps are 100% tested for luminous intensity, forward voltage, and reverse breakdown voltage per the Product Data Sheet. Also, all Avago Technologies yellow and green LED lamps are 100% tested for dominant wavelength. In order to minimize redundant testing, whenever possible, non-critical electrical/optical parameter test limits should reflect the standard customer test conditions and limits. Furthermore, the use of standard customer bin limits also helps to eliminate redundant testing. If the customer's specification uses the same numerical minimum and maximum luminous intensity values as the standard bin limits then additional testing costs can be minimized. For example, if luminous intensity bins C, D, E, F, and G are populated for a given lamp part number, then creating an LED specification for the luminous intensity limits that correspond to bins E and F will eliminate the need for redundant optical testing. In addition, in order to maximize final product yield and thus reduce costs, the most highly populated bins should be specified. Avago Technologies has set-up standard ordering options for a number of products to simplify the ordering of LED lamps with restricted luminous in-

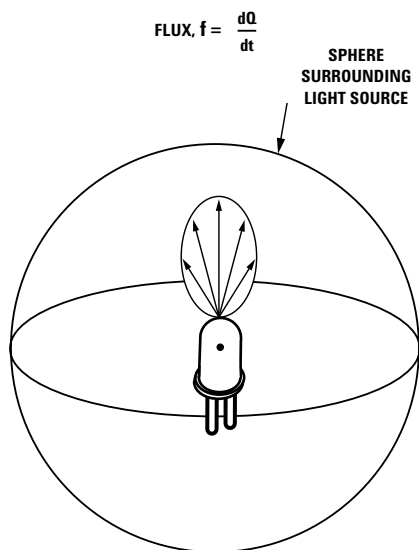

Figure 11. Sketch Showing Basic Concept of Flux Measurement.

tensity and color ranges. For critical electrical/optical parameters or any special product selection needs, please contact your local Avago Technologies field sales engineer to determine what tests can be performed.

The other LED lamp electrical/optical parameters have been characterized during the design of the product, but are not tested in production. These parameters include:

- luminous flux
- luminous efficiency
- luminous efficacy
- viewing angle
- peak wavelength
- spectral half-width
- speed of response
- junction capacitance
- thermal resistance

If these parameters are critical in the desired application, it is recommended that the Avago Technologies field sales engineer be consulted to determine what tests can be performed or whether these parameters can be guaranteed by testing another parameter (for example, in most cases a specified range of 1931 CIE chromaticity coordinates can be guaranteed by 100% testing of dominant wavelength).

Glossary - Optical Terms

LED lamps are characterized by a number of optical measurements that may not be familiar to the user. LED lamps are usually specified by their on-axis luminous intensity, viewing angle, and color. Other measurements that are useful include the radiant flux, luminous flux, luminous efficiency, luminous efficacy, color, and peak and dominant wavelength.

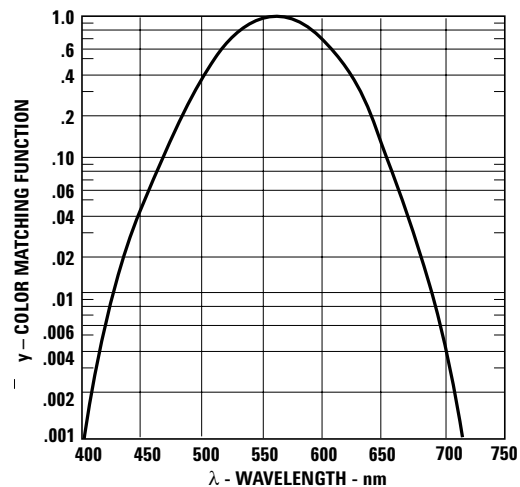

NOTE: PEAK LUMINOUS EFFICIENCY OF 683 lm/W OCCURS AT A PEAK WAVELENGTH.

Figure 12. 1931 CIE y Color Matching Function.

Radiant Flux

Radiant Flux is defined as the total electromagnetic energy per unit time emitted by the light source into a sphere (360°) surrounding the light source, as shown in Figure 11.

The measurement unit of radiant flux is the Watt (W).

Note that the measurement unit of radiant flux is the same as the measurement unit of electrical power (ie, $P_D = I_F V_F$). In both measurement systems, the term "Watt" refers to the energy per unit time consumed (electrical power) or emitted (radiant flux) by the light source. However, the measurements are completely different.

Radiant Efficiency

Radiant Efficiency is equal to the energy conversion efficiency of the light source in converting electrical watts into radiant flux. The unit of radiant efficiency is dimensionless (W/W). Radiant efficiency is typically expressed as a percentage.

Luminous Flux

Luminous Flux is defined as the total luminous energy per unit time emitted by the light source into a sphere (360°) surrounding the light source, where the luminous flux is the radiant flux multiplied by the human eye sensitivity.

The measurement unit for luminous flux is the lumen (lm).

The human eye sensitivity at different wavelengths is defined by the 1931 CIE (Commission Internationale de L'Eclairage) photometric curve, \bar{y} , as shown in Figure 12. For a given wavelength, the conversion factor for human eye sensitivity of light is equal to:

$$\phi_v(\lambda) = (683 \text{ lm/W}) \bar{y}(\lambda) \phi_e(\lambda)$$

where:

$$\phi_v(\lambda) = \text{luminous flux, lm.}$$

$$\phi_e(\lambda) = \text{radiometric flux, W.}$$

$$\bar{y}(\lambda) = \text{value of } \bar{y}, \text{ at wavelength } \lambda.$$

683 = efficiency of human eye (in units of lm/W) at highest wavelength sensitivity, which occurs at 555 nm.

Since most light sources are not monochromatic, the luminous flux generated by the light source is equal to the integration of the spectrum of the light source with the function, y . Thus, the luminous flux generated by the light source is equal to:

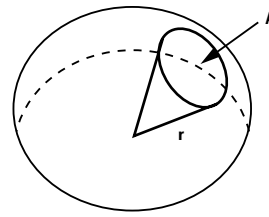

SOLID ANGLE, $\omega = A/r^2$

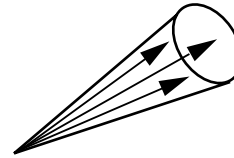

INTENSITY, $I = d\Phi / d\omega$

Figure 13. Luminous Intensity.

$$\Phi_v = (683 \text{ lm/W}) \int_{-\infty}^{+\infty} \bar{y}(\lambda) \phi_e(\lambda) d\lambda$$

Luminous flux is a useful measurement unit in applications where an optical reflector is used to capture all of the electromagnetic energy emitted by the light source and redirect it into a newly defined beam.

Luminous Intensity

Luminous Intensity is equal to the amount of luminous flux emitted into a very small solid angle, $d\omega$, at a defined angular orientation from the light source, as shown in Figure 13.

The measurement unit for luminous intensity is the lumen/steradian (lm/sr), or candela (cd).

The measurement of luminous intensity should not be confused with the measurement of mean spherical candelas (mscd) or mean spherical candle power (mscp) commonly used for small incandescent bulbs. The mean spherical candela or mean spherical candle power is defined as the average luminous intensity emitted by the light source in a sphere surrounding the light source. Since there are 4π steradians of solid angle captured in a sphere, the mean spherical candela or mean spherical candle power, in candelas, is equal to the luminous flux, in lumens, emitted by the light source divided by 4π . On the other hand, since most LED lamps have a well defined beam, the on-axis luminous intensity is much higher than the mean spherical luminous intensity.

$$I_v(\text{mscd}) = I_v(\text{mscp}) = \phi_v(\text{lm}) / 4\pi$$

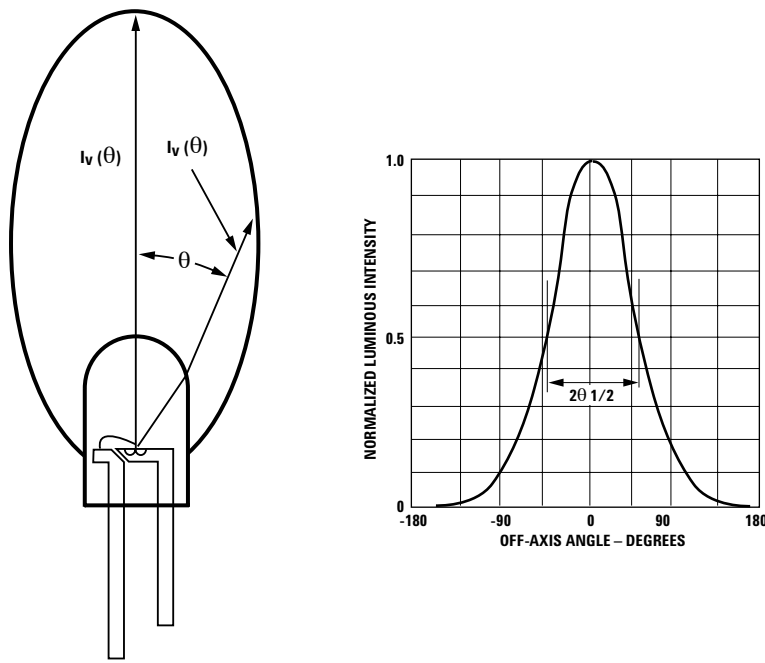

Figure 14. Typical Radiation Pattern for LED Lamp.

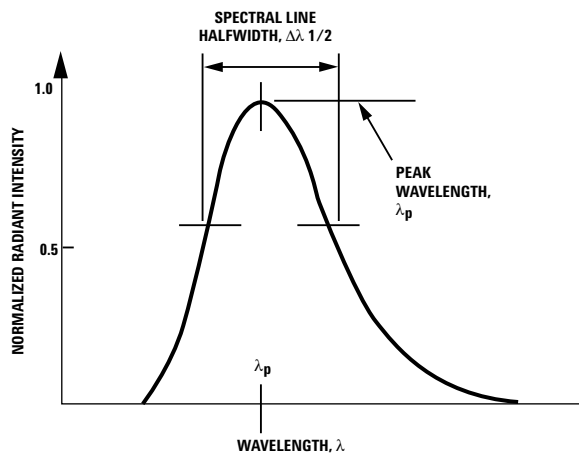

Figure 15. Typical Spectrum for LED Lamp.

In most applications, the luminous intensity and graph of luminous intensity versus off-axis angle better define the lighting requirements of an application, than simply the luminous flux emitted by the light source.

Avago Technologies LED lamps are 100% tested and binned for on-axis luminous intensity or luminous flux. When using luminous intensity, all lamps in a given bin appear equally bright to the human eye.

Avago Technologies' luminous intensity binning system consists of a series of overlapping bins with a ratio of 2.0 : 1.0 for the maximum and minimum luminous intensity values in a particular bin. Each luminous intensity bin is assigned a letter, ranging from A to Z. Bin A corresponds to the lowest luminous intensity range and bin

Z corresponds to the highest luminous intensity range. For a given LED lamp part number, only a few of these luminous intensity bins are populated. Your local Avago Technologies field sales engineer can provide you with further information about this luminous intensity binning system, as well as information about the populated range and most highly populated bin(s) for a given LED lamp part number.

Luminous Efficiency

Luminous Efficiency is equal to the energy conversion efficiency of the light source in converting electrical watts (i.e. for an LED lamp, equal to I_f times V_f) into luminous flux.

The unit of luminous efficiency is the lumen/Watt (lm/W).

Luminous Efficacy

Luminous Efficacy is equal to the conversion efficiency of the light source in converting radiant flux into luminous flux.

The unit of luminous efficacy is the lumen/Watt (lm/W).

Please note that luminous efficacy is not equal to luminous efficiency. For example, a TS AlInGaP amber LED lamp may have a luminous efficiency of 25 lm/W and a luminous efficacy of 480 lm/W. For this LED lamp, at 20 mA current and 2 V forward voltage, the luminous flux is equal to 1.0 lm (ie: $(0.02 \text{ A})(2 \text{ V})(25 \text{ lm/W})$) and the radiant flux is equal to 2.08 mW [ie: $(0.02 \text{ A})(2 \text{ V})(25 \text{ lm/W}) / (480 \text{ lm/W})$].

SYMBOL	COLOR NAME
R	RED
rO	REDDISH-ORANGE
O	ORANGE
yO	YELLOWISH-ORANGE
Y	YELLOW
gY	GREENISH-YELLOW
YG	YELLOW-GREEN
yG	YELLOWISH-GREEN
G	GREEN
bG	BLUISH GREEN
BG	BLUE-GREEN
gB	GREENISH-BLUE
B	BLUE
pB	PURPLISH-BLUE
bP	BLUISH-PURPLE
P	PURPLE
rP	REDDISH-PURPLE
RP	RED-PURPLE
pR	PURPLISH-RED
pPK	PURPLISH-PINK
PK	PINK
OPK	ORANGE-PINK
W	WHITE

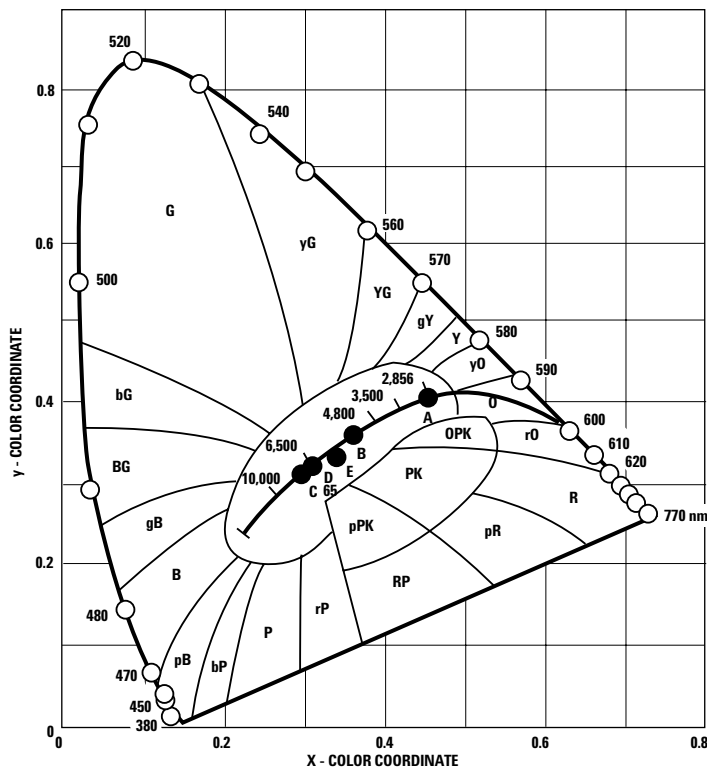

Figure 16. 1931 CIE Color Space.

Viewing Angle

$\theta^{1/2}$ is defined as the off-axis angle where the luminous intensity is one-half of the on-axis value (i.e., the one-half power point in the spatial distribution of light), as shown in Figure 14. For most LED lamps, the luminous intensity is the highest value on-axis, and falls off symmetrically at angles off-axis.

$2\theta^{1/2}$ is the measurement unit for viewing angle. This is defined as the total included angle where the luminous intensity falls to one-half of the on-axis luminous intensity.

Peak Wavelength

Peak Wavelength is defined as the single wavelength where the radiometric emission spectrum of the light source reaches its maximum, as shown in Figure 15.

The nanometer (nm) or angstrom (Å) is the measurement unit for peak wavelength. Light falls in the range of 380 to 700 nm (3800 to 7000 Å).

1931 CIE Color Coordinate

The 1931 CIE (Commission Internationale de L'Eclairage) Color Coordinate is defined as the (x, y) coordinate in the 1931 CIE chromaticity diagram.

In 1931 CIE created a two dimensional color space that defines all of the colors perceived by the human eye. This color space, called the 1931 CIE chromaticity dia-

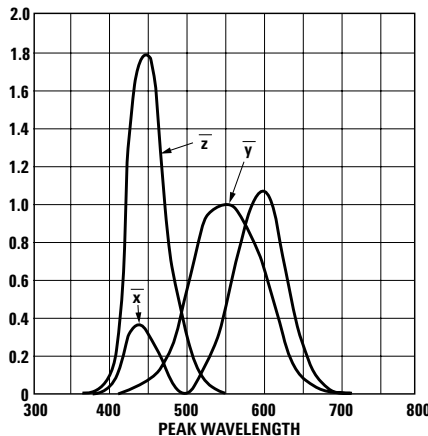

Figure 17. 1931 CIE Color Matching Functions.

gram is shown in Figure 16. Pure colors are located on the extreme outer edges of the diagram and white is located in the center. Also shown in Figure 16 is the locus of points for black body radiators of different color temperatures. These color coordinates correspond to the non-technical definition of “white” light. CIE has also defined several white colors called “illuminants” that are the color coordinates for several commonly used illumination sources. In Figure 16, these illuminants are labeled “A”, “B”, “C”, “D₆₅”, and “E”.

Color coordinates within the diagram can be considered to be a mixture of white light and monochromatic highly saturated light. As the point moves inward, the percentage of white light increases while the percentage of monochromatic highly saturated light is reduced.

The color coordinate, (x, y) , is calculated by integrating the spectrum of the light source with three different functions called the 1931 CIE color matching functions, \bar{x} , \bar{y} , and \bar{z} , as shown below. These 1931 CIE color matching functions are shown in Figure 17:

$$x = \frac{X}{X + Y + Z}$$

$$y = \frac{Y}{X + Y + Z}$$

$$X = \int \bar{x}(\lambda) s(\lambda) d\lambda$$

$$Y = \int \bar{y}(\lambda) s(\lambda) d\lambda$$

$$Z = \int \bar{z}(\lambda) s(\lambda) d\lambda$$

where:

(x, y) = color coordinate of the light source.

$\bar{x}(\lambda)$ = 1931 CIE \bar{x} color matching function.

$\bar{y}(\lambda)$ = 1931 CIE \bar{y} color matching function, also known as $V'(\lambda)$ the luminosity function.

$\bar{z}(\lambda)$ = 1931 CIE \bar{z} color matching function.

$s(\lambda)$ = spectrum of light source, unit, W/nm.

Since LED lamps are narrow-band light sources, their 1931 CIE (x, y) color coordinate lies very close to the edge of the 1931 CIE chromaticity diagram.

Dominant Wavelength

Dominant Wavelength is defined as the wavelength of monochromatic light that has the same apparent color as the light source.

The nanometer is the measurement unit for dominant wavelength. The dominant wavelength of light falls in the range of 380 to 700 nm.

The dominant wavelength is measured by first measuring the 1931 (x, y) coordinate of the light source. Then a line is extended from one of the 1931 CIE white illuminants, through the (x, y) coordinate to the edge of the color space, as shown in Figure 18. The CIE illuminants and their definitions are shown below. The choice of the illuminant is usually determined by the type of overhead ambient lighting. Illuminant E is typically used in night time applications where there is no overhead ambient lighting. Then, the dominant wavelength is equal to the intercept of the line and the outer edge of the color space.

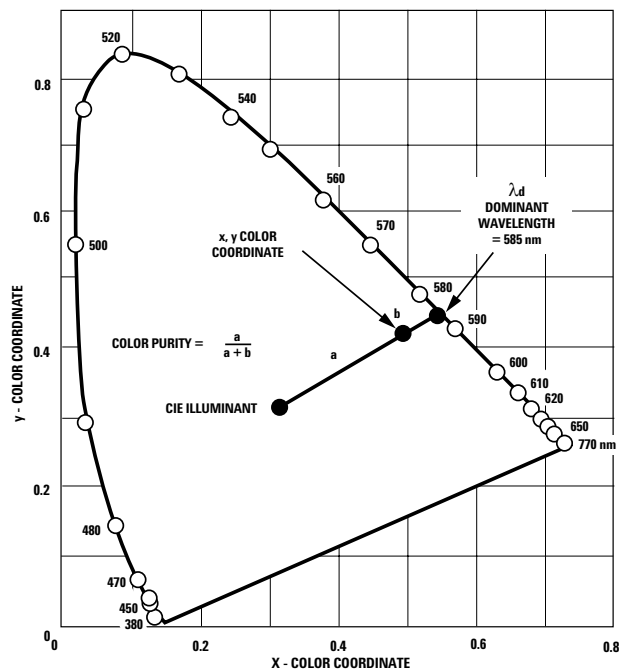

Figure 18. Dominant Wavelength Calculation.

Illuminant A = (0.4476, 0.4074), 2856°K Incandescent Source.

Illuminant B = (0.3484, 0.3516), Direct Sunlight, approximately 4870°K.

Illuminant C = (0.3101, 0.3162), Overcast Sunlight, approximately 6770°K.

Illuminant D₆₅ = (0.3128, 0.3292), Daylight, approximately 6504°K.

Illuminant E = (0.3333, 0.3333), Equal Energy.

Note: CIE illuminant E is an imaginary color that has equal amounts of X, Y, and Z energy.

Note that dominant wavelength is not the same as peak wavelength because the spectrum of an LED lamp is not symmetrical, and also because the 1931 CIE weighting factors (\bar{x} , \bar{y} , and \bar{z}) vary nonuniformly with wavelength.

Since LED lamps are narrow-band light sources, the 1931 CIE (x, y) color coordinate of the light source is approximately equal to the (x, y) coordinate of the dominant wavelength on the outer edge of the chromaticity diagram.

Green and yellow Avago Technologies LED lamps are 100% tested for dominant wavelength and binned into dominant wavelength ranges, such that the color of all lamps in a given bin appear the same color to the human eye.

Avago Technologies' color binning system consists of a series of overlapping bins with a minimum and maximum dominant wavelength for each particular bin. The width of each color bin varies from 3.5 nm for yellow LED lamps, to 4.0 nm for green LED lamps. Each color bin is assigned a number or letter. For a given LED lamp part number, only some of these color bins are populated. Your local Avago Technologies field sales engineer can provide you with further information about this color binning system, as well as information about the populated range and most highly populated bin(s) for a given LED lamp part number.

For product information and a complete list of distributors, please go to our web site: www.avagotech.com

Avago, Avago Technologies, and the A logo are trademarks of Avago Technologies, Pte. in the United States and other countries. Data subject to change. Copyright © 2006 Avago Technologies Pte. All rights reserved.
5988 - _____ - June 16, 2006

