

ASMC-PxB9-Txxxx

Envisium™ Power PLCC-4 Surface Mount LED



Data Sheet



Lead (Pb) Free
RoHS 6 fully
compliant



Envisium

Envisium™ is the premier class of mid-Power LEDs from Avago and Lumileds utilizing the very best solid-state lighting technologies from these two industry leaders. Envisium™ LEDs offer unparalleled performance, engineering and design flexibility. For the very first time, customers have options for mid-power LEDs.

Description

The Envisium™ Power PLCC-4 SMT LED is an extension of Avago's PLCC-4 SMT LEDs. The package can be driven at high current due to its superior package design. The product is able to dissipate the heat more efficiently compared to the conventional PLCC-2 SMT LEDs. These LEDs produce higher light output with better flux performance compared to the conventional PLCC-4 SMT LEDs.

The Envisium™ Power PLCC-4 SMT LEDs are designed for higher reliability, better performance, and operate under a wide range of environmental conditions. The performance characteristics of these new mid-power LEDs make them uniquely suitable for use in harsh conditions such as in automotive applications, and in electronics signs and signals.

To facilitate easy pick and place assembly, the LEDs are packed in EIA-compliant tape and reel. Every reel is shipped in single intensity and color bin (except for red), to provide close uniformity. These LEDs are compatible with the IR solder reflow process. Due to the high reliability feature of these products, they also can be mounted using through-the-wave soldering process.

The Envisium™ Power PLCC-4 SMT LED is available in 3 colors, red, red-orange and amber.

Features

- Industry standard PLCC-4 (Plastic Leaded Chip Carrier)
- High reliability LED package
- Mid-Power intensity brightness with optimum flux performance using TS AllnGaP dice technologies
- Available in Red, Red Orange and Amber colors
- High optical efficiency
- Higher ambient temperature at the same current possible compared to PLCC-2
- Super wide viewing angle at 120°
- Available in 8 mm carrier tape on 7-inch reel
- Compatible with both IR and TTW soldering process

Applications

- Interior automotive
 - Instrument panel backlighting
 - Central console backlighting
 - Navigation and audio system
 - Push button backlighting
- Exterior automotive
 - Turn signals
 - Side repeaters
 - CHMSL
 - Rear combination lamp
 - Puddle light
- Electronic signs and signals
 - Channel lettering
 - Contour lighting
 - Indoor variable message sign
- Office automation, home appliances, industrial equipment
 - Front panel backlighting
 - Push button backlighting
 - Display backlighting

Package Dimensions

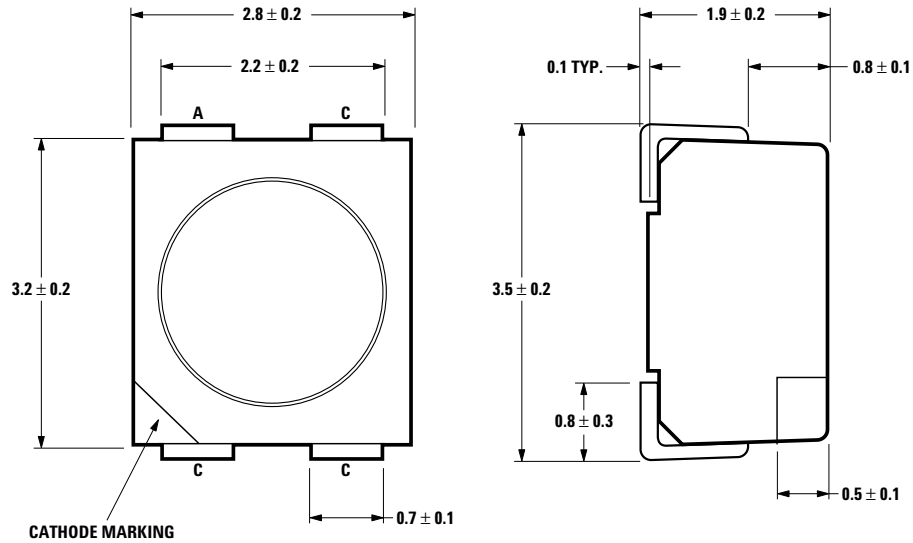

NOTE: ALL DIMENSIONS IN mm.

Table 1. Device Selection Guide

Color	Part Number	Intensity Bin	Min. IV (mcd)	Max. IV (mcd)	Total Flux Φ_V (mlm) ^[2,3]	Test Current (mA)	Dice Technology
					Typ.		
Red	ASMC-PRB9-TV005	V1	715.0	900.0	2600.0	50	AlInGaP
		V2	900.0	1125.0	3300.0		
		W1	1125.0	1400.0	-		
Red Orange	ASMC-PHB9-TW005	W1	1125.0	1400.0	4300.0	50	AlInGaP
		W2	1400.0	1800.0	5000.0		
		X1	1800.0	2240.0	-		
Amber	ASMC-PAB9-TV005	V1	715.0	900.0	2600.0	50	AlInGaP
		V2	900.0	1125.0	3800.0		
		W1	1125.0	1400.0	-		

Notes

1. The luminous intensity, I_v , is measured at the mechanical axis of the lamp package. The actual peak of the spatial radiation pattern may not be aligned with this axis.
2. Φ_V is the total luminous flux output as measured with an integrating sphere after the device has stabilized.
3. Flux tested at mono pulse conditions.
4. Tolerance = $\pm 12\%$

Part Numbering System

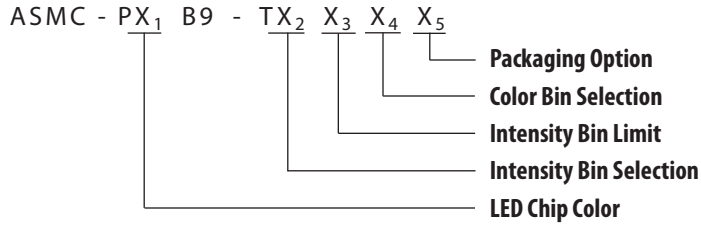

Absolute Maximum Ratings (T_A = 25°C)

Parameters	ASMC-PxB9-Txxxx
DC Forward Current ^[1]	70 mA ^[3,4]
Peak Forward Current ^[2]	200 mA
Power Dissipation	240 mW
Reverse Voltage	5 V
Junction Temperature	125°C
Operating Temperature	-40°C to +100°C
Storage Temperature	-40°C to +100°C

Notes:

- Derate linearly as shown in figure 4.
- Duty factor = 10%, Frequency = 1 kHz.
- Drive current between 10 mA and 70 mA is recommended for best long-term performance.
- Operation at currents below 5 mA is not recommended.

Optical Characteristics (T_A = 25°C)

Color	Part Number	Dice Technology	Peak Wavelength	Dominant Wavelength	Viewing Angle 2θ ^{1/2} ^[2]	Luminous Efficacy η _v ^[3]	Luminous Intensity/ Total Flux
			λ _{PEAK} (nm) Typ.	λ _D ^[1] (nm) Typ.	(Degrees) Typ.	(lm/W) Typ.	I _v (mcd)/ Φ _v ^[4] (lm) Typ.
Red	ASMC-PRB9-Txxx5	AllnGaP	639.0	630.0	120	155	0.30
Red Orange	ASMC-PHB9-Txxx5	AllnGaP	623.0	617.0	120	263	0.29
Amber	ASMC-PAB9-Txxx5	AllnGaP	594.0	592.0	120	500	0.26

Notes:

- The dominant wavelength, λ_D, is derived from the CIE Chromaticity Diagram and represents the color of the device.
- θ^{1/2} is the off-axis angle where the luminous intensity is 1/2 the peak intensity.
- Radiant intensity, I_e in watts/steradian, may be calculated from the equation I_e = I_v/η_v, where I_v is the luminous intensity in candelas and η_v is the luminous efficacy in lumens/watt.
- Φ_v is the total luminous flux output as measured with an integrating sphere at mono pulse conditions.

Electrical Characteristics (T_A = 25°C)

Part Number	Forward Voltage V _F (Volts) @ I _F = 50 mA		Reverse Voltage V _R @ 100 μA
	Typ.	Max.	Min.
ASMC-PxB9-Txxx5	2.8	3.4	5

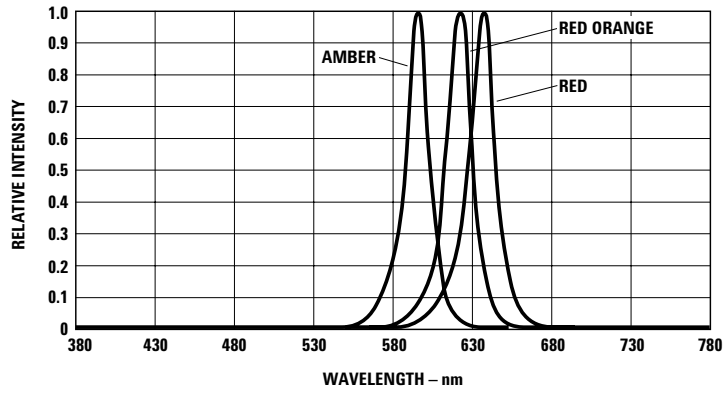

Figure 1. Relative intensity vs. wavelength.

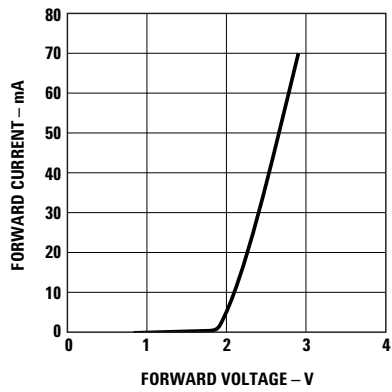

Figure 2. Forward current vs. forward voltage.

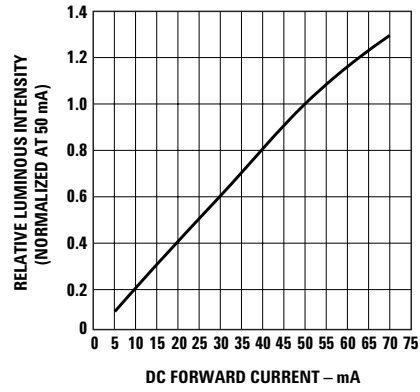

Figure 3. Relative intensity vs. forward current.

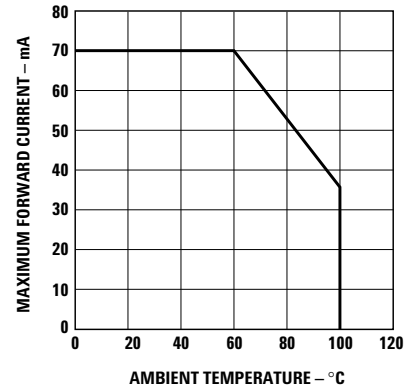

Figure 4. Maximum forward current vs. ambient temperature. Derated based on $T_{MAX} = 125^{\circ}C$, $R_{\theta JA} = 300^{\circ}C/W$.

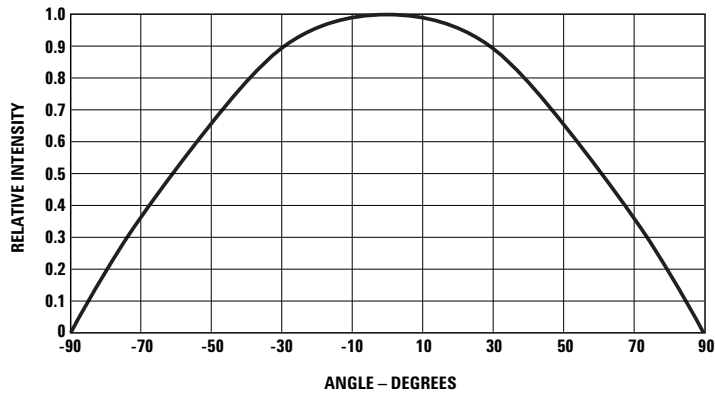

Figure 5. Radiation pattern.

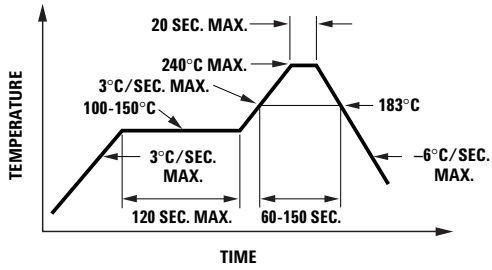
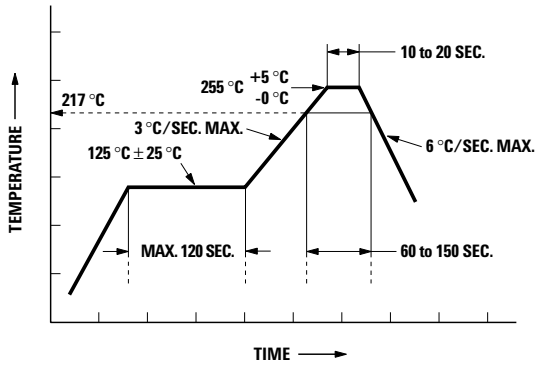

Figure 6a. Recommended Sn-Pb reflow soldering profile.



* THE TIME FROM 25 °C TO PEAK TEMPERATURE = 6 MINUTES MAX.

Figure 6b. Recommended Pb-free reflow soldering profile.

Note: For detailed information on reflow soldering of Avago surface mount LEDs, do refer to Avago Application Note AN 1060, *Surface Mounting SMT LED Indicator Components*.

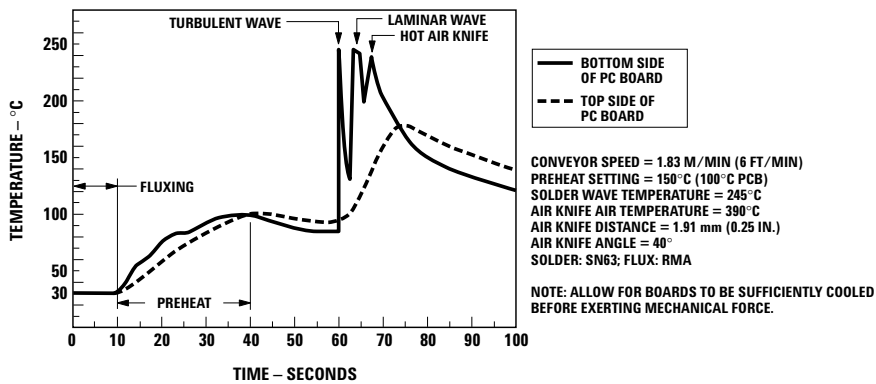

Figure 7. Recommended wave soldering profile.

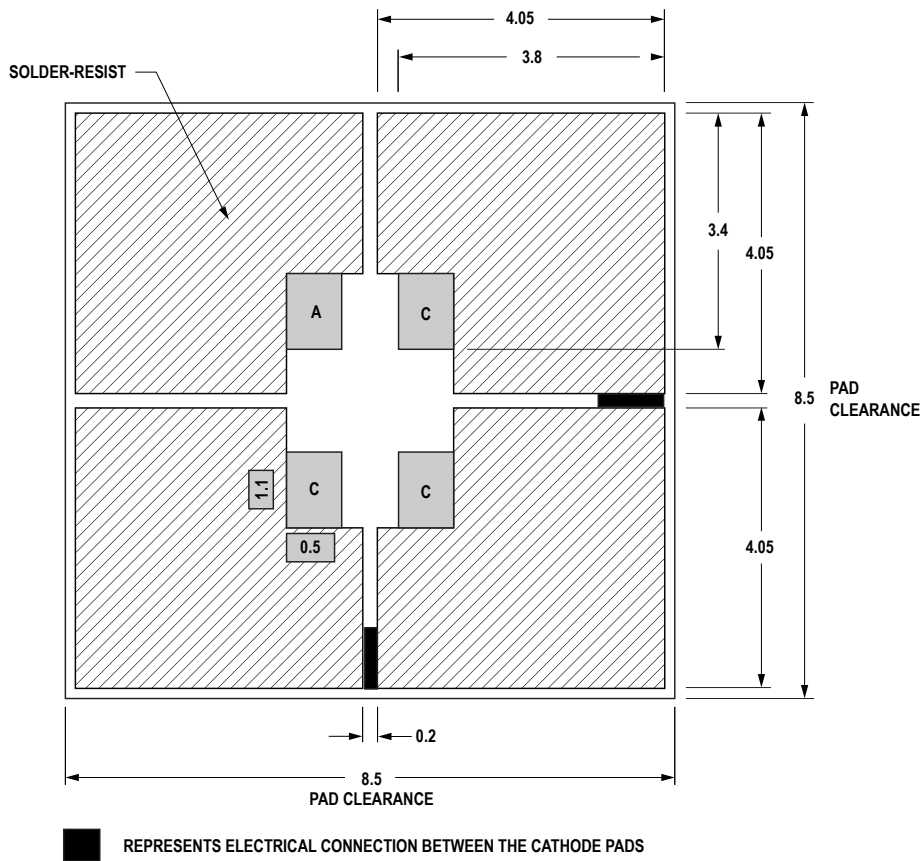

Figure 8. Recommended soldering pad pattern.

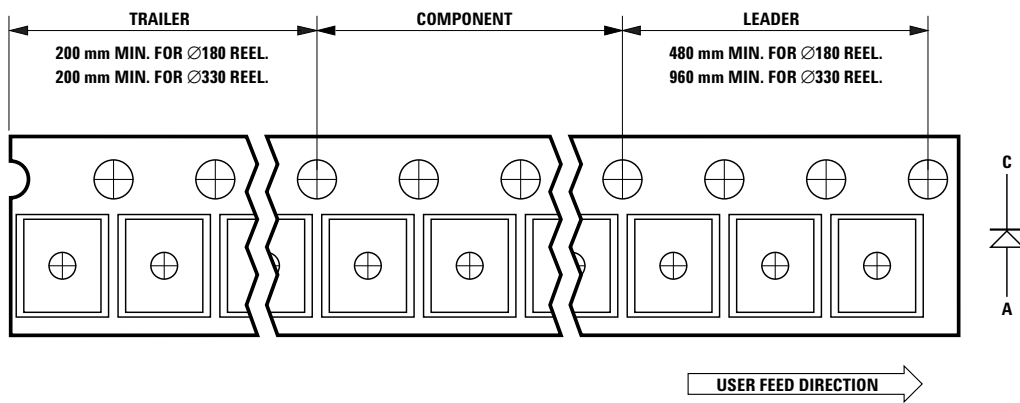

Figure 9. Tape leader and trailer dimensions.

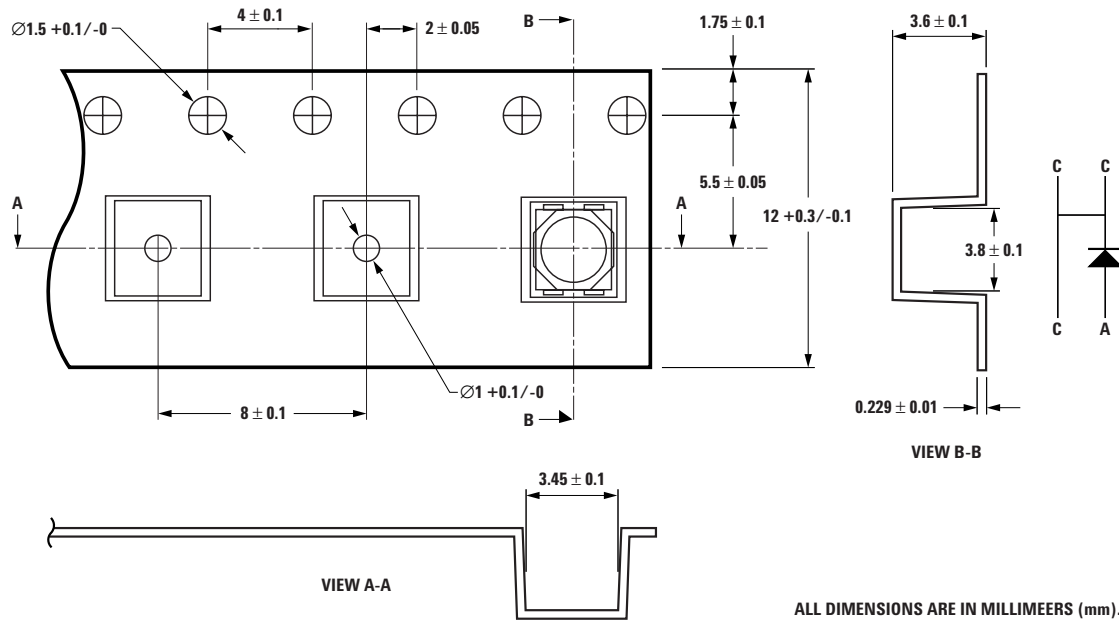

Figure 10. Tape dimensions.

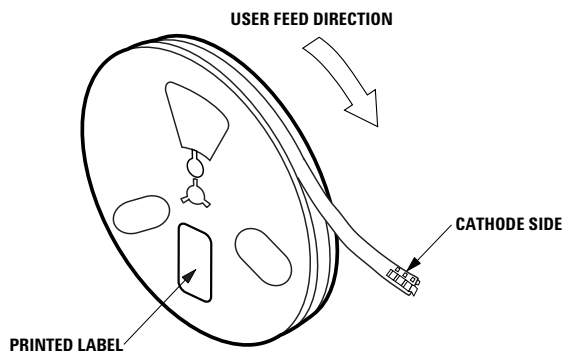

Figure 11. Reeling orientation.

This product is qualified as Moisture Sensitive Level 2a per Jec J-STD-020. Precaution when handling this moisture sensitive product is important to ensure the reliability of the product. Do refer to Avago Application Note AN5305 Handling of Moisture Sensitive Surface Mount Devices for details.

A. Storage before use

- Unopen moisture barrier bag (MBB) can be stored at <math><40^{\circ}\text{C}/90\% \text{RH}</math> for 12 months. If the actual shelf life has exceeded 12 months and the HIC indicates that baking is not required, then it is safe to reflow the LEDs per the original MSL rating.
- It is not recommended to open the MBB prior to assembly (e.g., for IQC).

B. Control after opening the MBB

- The humidity indicator card (HIC) shall be read immediately upon opening of MBB.

- The LEDs must be kept at <math><30^{\circ}\text{C}/60\% \text{RH}</math> at all times and all high temperature related processes, including soldering, curing or rework, need to be completed within 672 hours.

C. Control for unfinished reel

- For any unused LEDs, they need to be stored in sealed MBB with desiccant or desiccator at <math><5\% \text{RH}</math>.

D. Control of assembled boards

- If the PCB soldered with the LEDs is to be subjected to other high temperature processes, the PCB needs to be stored in sealed MBB with desiccant or desiccator at <math><5\% \text{RH}</math> to ensure no LEDs have exceeded their floor life of 672 hours.

E. Baking is required if:

- "10%" is Not blue and "5%" HIC indicator turns pink.
- The LEDs are exposed to condition of $>30^{\circ}\text{C}/60\% \text{RH}$ at any time.
- The LEDs floor life exceeded 672 hours.

Recommended baking condition: $60 \pm 5^{\circ}\text{C}$ for 20 hours.

Intensity Bin Select (X₂X₃)

Individual reel will contain parts from one half bin only

X ₂	Min I _v Bin
X ₃	
0	Full Distribution
2	2 half bins starting from X ₂ 1
3	3 half bins starting from X ₂ 1
4	4 half bins starting from X ₂ 1
5	5 half bins starting from X ₂ 1
6	2 half bins starting from X ₂ 2
7	3 half bins starting from X ₂ 2
8	4 half bins starting from X ₂ 2
9	5 half bins starting from X ₂ 2

Intensity Bin Limits & Typical Flux

Bin ID	Min. (mcd)	Max. (mcd)
V1	715.00	900.00
V2	900.00	1125.00
W1	1125.00	1400.00
W2	1400.00	1800.00
X1	1800.00	2240.00
X2	2240.00	2850.00

Tolerance of each bin limit = ±12%

Forward Voltage Bin Table

For ASMC-PXB9-Txxxx only

Bin	Min.	Max.
VA	1.9	2.2
VB	2.2	2.5
VC	2.5	2.8
VD	2.8	3.1
VE	3.1	3.4

Tolerance of each bin limit = ±0.05.

Color Bin Select (X₄)

Individual reel will contain parts from one full bin only.

X ₄	
0	Full Distribution
A	1 and 2 only
B	2 and 3 only
C	3 and 4 only
D	4 and 5 only
E	5 and 6 only
G	1, 2 and 3 only
H	2, 3 and 4 only
J	3, 4 and 5 only
K	4, 5 and 6 only
M	1, 2, 3 and 4 only
N	2, 3, 4 and 5 only
P	3, 4, 5 and 6 only
R	1, 2, 3, 4, and 5 only
S	2, 3, 4, 5 and 6 only

Packaging Option (X₅)

Option	Test Current	Package Type	Reel Size
5	50 mA	Top Mount	7 inch

Color Bin Limits

Amber/ Yellow	Min. (nm)	Max. (nm)
1	582.0	584.5
2	584.5	587.0
3	587.0	589.5
4	589.5	592.0
5	592.0	594.5
6	594.5	597.0

Red Orange	Min. (nm)	Max. (nm)
1	611.0	616.0
2	616.0	620.0

Red	Min. (nm)	Max. (nm)
Full Distribution		

Tolerance of each bin limit = ± 1 nm.

For product information and a complete list of distributors, please go to our website: www.avagotech.com

Avago, Avago Technologies, and the A logo are trademarks of Avago Technologies Limited in the United States and other countries.
 Data subject to change. Copyright © 2005-2008 Avago Technologies Limited. All rights reserved. Obsoletes 5989-3096EN
 AV02-0495EN - June 23, 2008

Avago
TECHNOLOGIES