



3-Channel LED Driver in 3x3mm Package

FEATURES

- Drives up to 3 LEDs
- Current setting resistor
- Compatible with supply voltage of 3V to 5.5V
- Power efficiency up to 91%
- Output Current up to 30mA per LED
- Fractional pump 1x/1.5x
- Low noise input ripple
- Fixed High Frequency Operation 1MHz
- “Zero” Current Shutdown Mode
- Soft start and current limiting
- Short circuit protection
- 12-lead TDFN 3mm x 3mm package

APPLICATION

- LCD Display Backlight
- Cellular Phones
- Digital Still Cameras
- Handheld Devices

ORDERING INFORMATION

Part Number	Package	Quantity per Reel	Package Marking
CAT3603HV2	TDFN-12 3x3 Green*	2,000	HABB

* Lead Finish Matte-Tin

For Ordering Information details, see page 11.

DESCRIPTION

The CAT3603 is a charge pump LED driver operating in either 1x (LDO) mode or 1.5x fractional mode regulating current through each of the 3 LED pins. Operation at a constant switching frequency of 1MHz allows the use of very small value ceramic capacitors.

The CAT3603 drives 3 white LEDs in parallel and provides tightly matched regulated current to achieve uniform brightness in LCD backlighting applications. An external resistor, RSET, controls the output current level. The device can deliver up to 30mA over an input voltage supply range from 3V to 5.5V, making it ideal for battery-powered applications

LED dimming can be accomplished using several methods; using a DC voltage to set the RSET pin current, applying a PWM signal on the EN pin, or adding a switched resistor in parallel with RSET. The EN input pin allows the device to be placed in power-down mode with “near-zero” quiescent current.

The device is available in the tiny 12-lead thin DFN 3mm x 3mm package with a max height of 0.8mm.

PIN CONFIGURATION

12-lead TDFN 3mm (Top view)

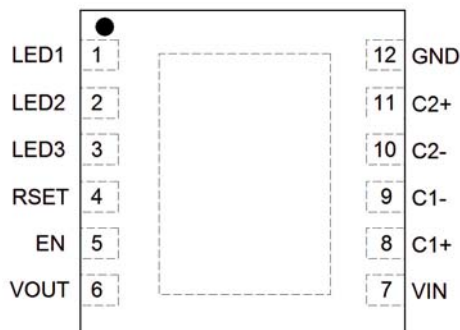

TYPICAL APPLICATION CIRCUIT

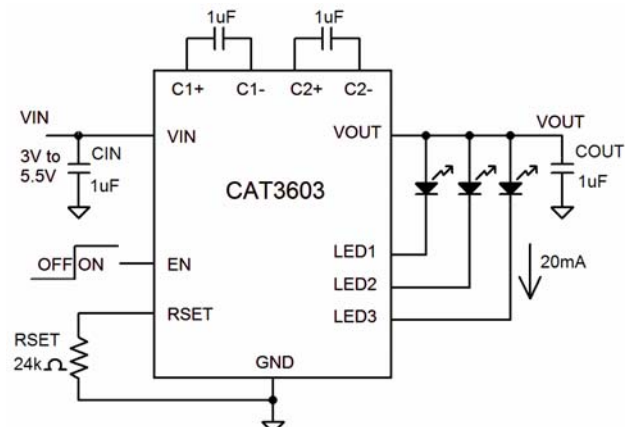

Note: Unused LED channels must be connected to VOUT.

ABSOLUTE MAXIMUM RATINGS

Parameter	Rating	Unit
VIN, VOUT, LEDx voltage	-0.3 to 7.0	V
EN voltage	-0.3 to VIN	V
RSET voltage	-0.3 to VIN	V
Junction Temperature Range	-40 to +150	°C
Storage Temperature Range	-65 to +160	°C
Lead Temperature	300	°C
ESD Ratings		
Human Body Model (HBM)	2000	V
Machine Model (MM)	200	V

RECOMMENDED OPERATING CONDITIONS

Parameter	Range	Unit
VIN	3 to 5.5	V
Ambient Temperature Range	-40 to +85	°C
Input, Output, Bucket Capacitors	1 ±20% typical	µF
I _{LED} per LED pin	0 to 30	mA

Typical application circuit with external components are shown on page 1.

ELECTRICAL OPERATING CHARACTERISTICS

VIN = 3.6V, EN = High, ambient temperature of 25°C (over recommended operating conditions unless specified otherwise).

Symbol	Parameter	Conditions	Min	Typ	Max	Unit
I _Q	Quiescent Current	V _{EN} = 0V, shutdown mode 1x Mode, No Load 1.5x Mode, No Load		0.1 0.4 2.7	1 1 5	µA mA mA
V _{RSET}	RSET Regulated Voltage		1.17	1.2	1.23	V
I _{LED}	Programmed LED Current	I _{RSET} = 5µA I _{RSET} = 37µA I _{RSET} = 78µA		2.4 15.0 30.0		mA mA mA
I _{LED-ACC}	LED Current Accuracy	0.5mA ≤ I _{LED} ≤ 3mA 3mA ≤ I _{LED} ≤ 30mA		±15 ±5		% %
I _{LED-DEV}	LED Channel Matching	(I _{LED} - I _{LEDAVG}) / I _{LEDAVG}		±3		%
R _{OUT}	Output Resistance (Open Loop)	1x Mode 1.5x Mode, I _{OUT} = 100mA		1.4 6.5	2.5 10	Ω Ω
f _{OSC}	Charge Pump Frequency		0.8	1.0	1.3	MHz
T _{DROPOUT}	1x to 1.5x Mode Transition Dropout Delay		0.4	0.6	0.9	ms
I _{EN}	Input Leakage Current	On Input EN			1	µA
V _{EN}	High Detect Threshold Low Detect Threshold	On Input EN	0.4	0.8 0.7	1.3	V V
I _{SC}	Short Circuit Output Current	VOUT = GND	30	45	60	mA
I _{LIM}	Maximum Input Current	VOUT > 1V	200	400	600	mA
T _{SD}	Thermal Shutdown			150		°C
T _{HYS}	Thermal Hysteresis			20		°C
V _{UVLO}	Undervoltage lock out (UVLO) threshold			2		V

TYPICAL CHARACTERISTICS

$V_{IN} = 3.6V$, $I_{OUT} = 60mA$ (3 LEDs at 20mA), $C_1 = C_2 = C_{IN} = C_{OUT} = 1\mu F$, $T_{AMB} = 25^\circ C$ unless otherwise specified.

Efficiency vs. Input Voltage (3 LEDs on)

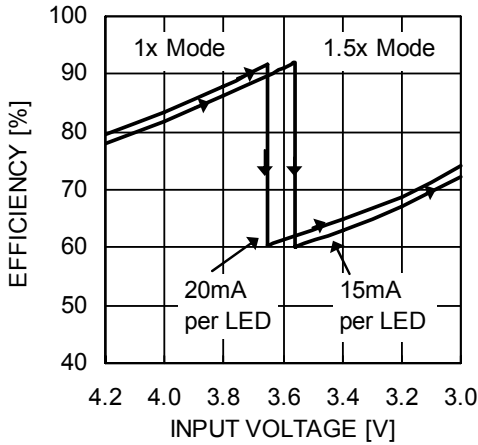

Efficiency vs. Total LED Current (3 LEDs)

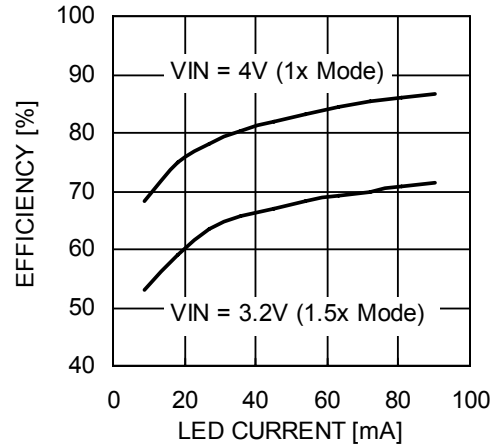

Quiescent Current vs. Input Voltage (1x Mode)

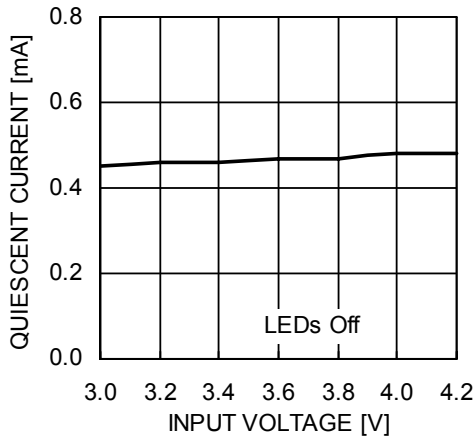

Quiescent Current vs. Temperature (1x Mode)

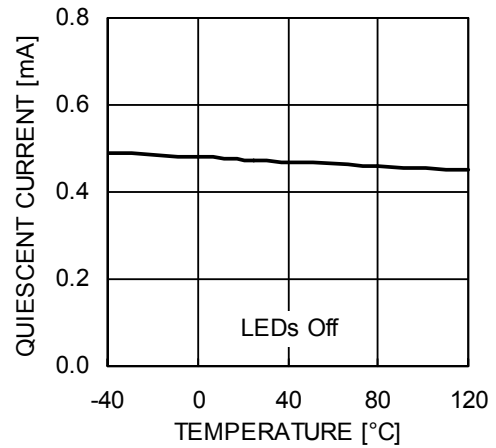

Quiescent Current vs. Input Voltage (1.5x Mode)

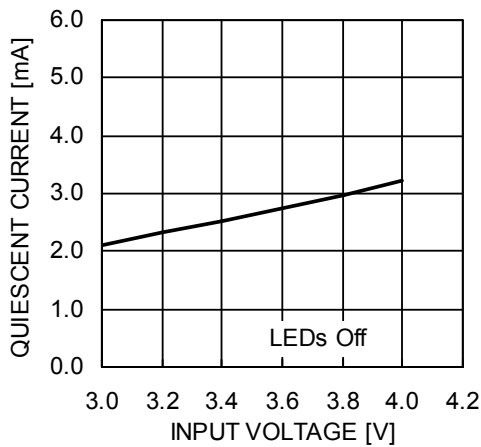

Quiescent Current vs. Temperature (1.5x Mode)

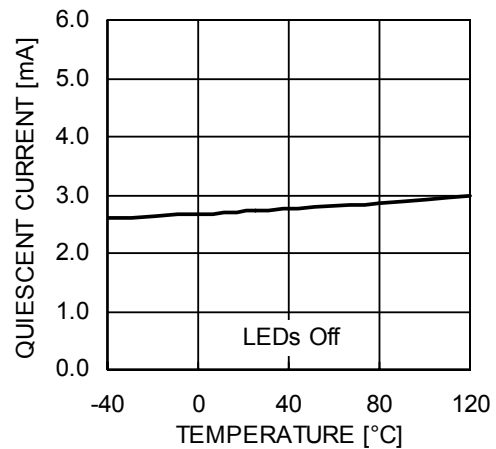

TYPICAL CHARACTERISTICS

$V_{IN} = 3.6V$, $I_{OUT} = 60mA$ (3 LEDs at 20mA), $C_1 = C_2 = C_{IN} = C_{OUT} = 1\mu F$, $T_{AMB} = 25^\circ C$ unless otherwise specified.

LED Current Change vs. Input Voltage

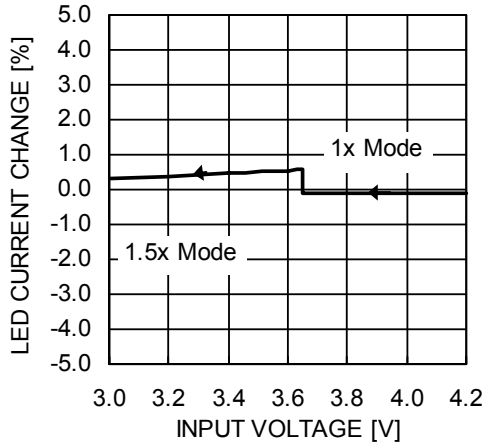

LED Current Change vs. Temperature

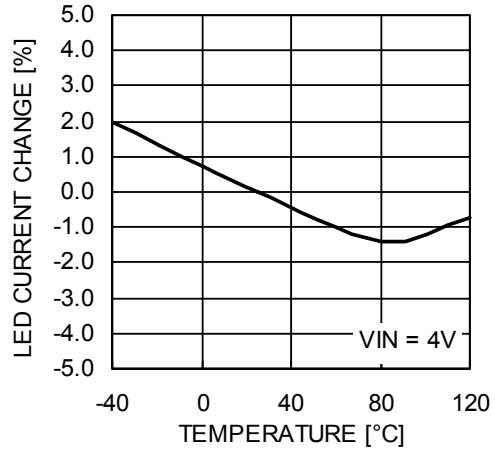

Switching Frequency vs. Input Voltage

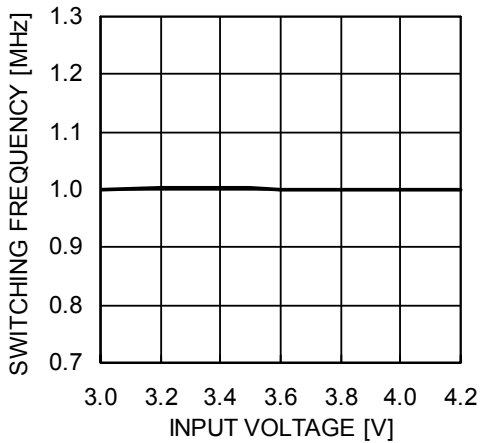

Switching Frequency vs. Temperature

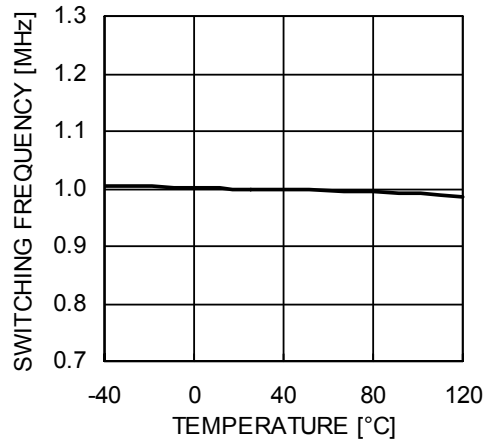

Output Resistance vs. Input Voltage (1x Mode)

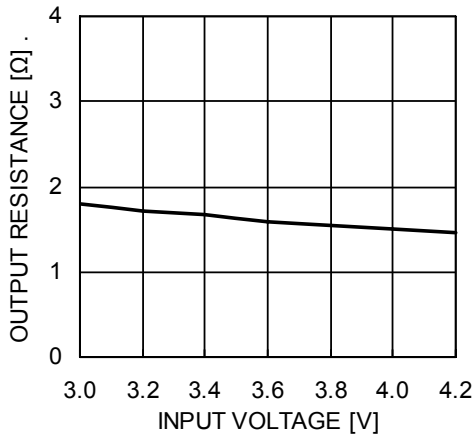

Output Resistance vs. Input Voltage (1.5x Mode)

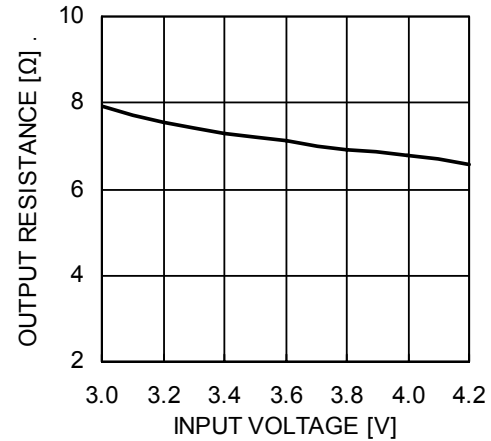

TYPICAL CHARACTERISTICS

$V_{IN} = 3.6V$, $I_{OUT} = 60mA$ (3 LEDs at 20mA), $C_1 = C_2 = C_{IN} = C_{OUT} = 1\mu F$, $T_{AMB} = 25^\circ C$ unless otherwise specified.

Switching Waveforms in 1.5x Mode

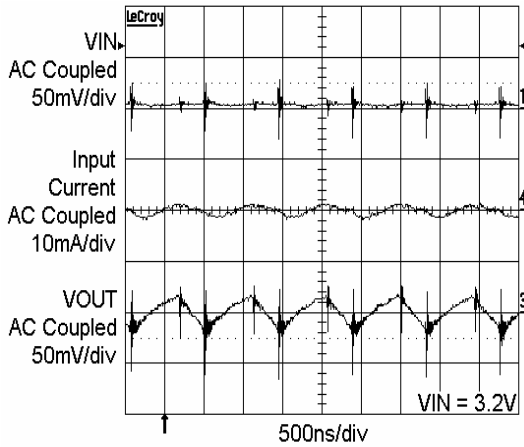

Operating Waveforms in 1x Mode

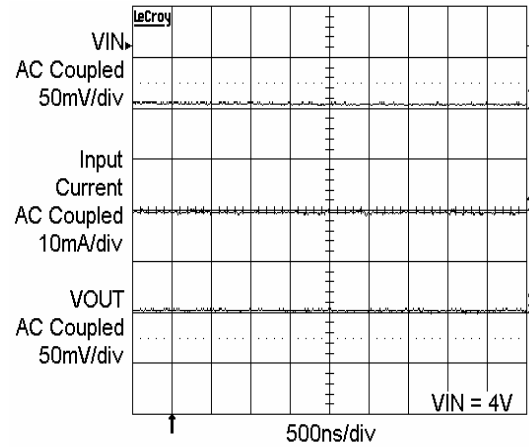

Power Up 3 LEDs at 20mA, $V_{IN} = 3.2V$ (1.5x Mode)

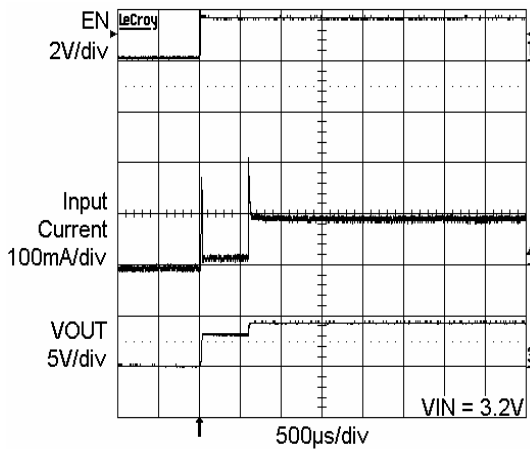

Power Up 3 LEDs at 20mA, $V_{IN} = 4V$ (1x Mode)

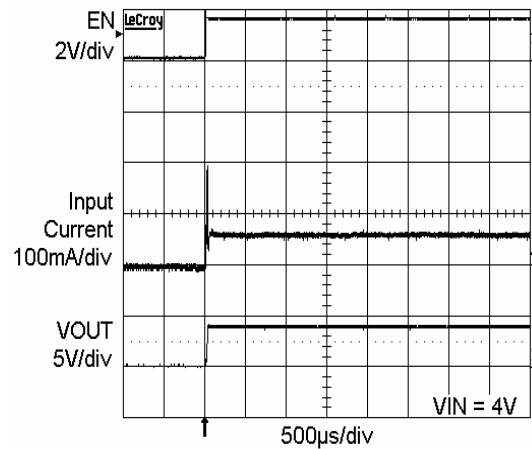

LED Current vs. R_{SET}

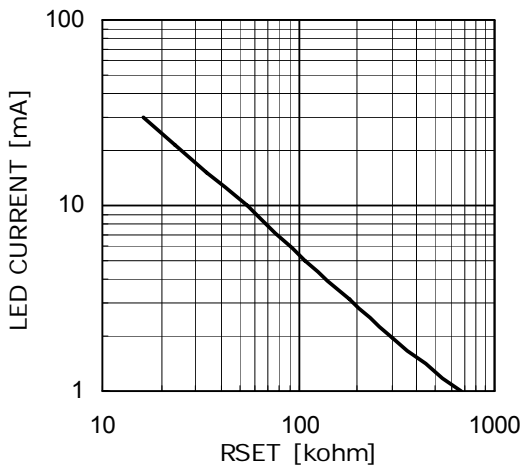

Line Transient Response in 1x Mode

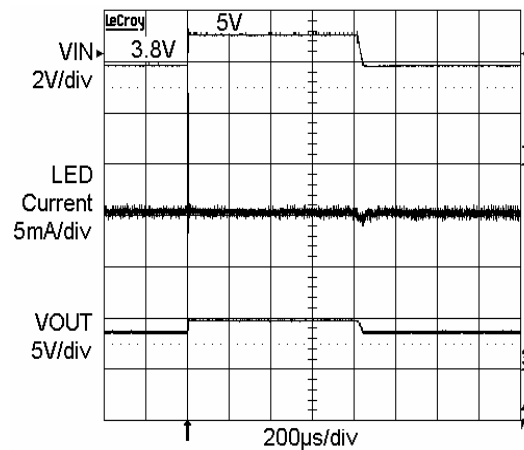

TYPICAL CHARACTERISTICS

V_{IN} = 3.6V, I_{OUT} = 60mA (3 LEDs at 20mA), C₁ = C₂ = C_{IN} = C_{OUT} = 1μF, T_{AMB} = 25°C unless otherwise specified.

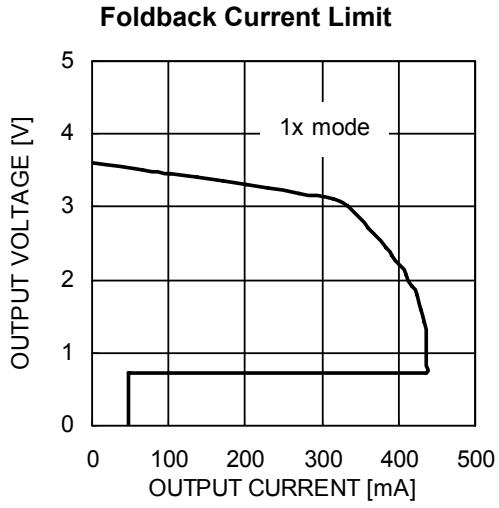

PIN DESCRIPTIONS

Pin #	Name	Function
1	LED1	LED1 cathode terminal (if not used, connect to VOUT) ⁽¹⁾
2	LED2	LED2 cathode terminal (if not used, connect to VOUT) ⁽¹⁾
3	LED3	LED3 cathode terminal (if not used, connect to VOUT) ⁽¹⁾
4	RSET	The LED output current is set by the current sourced out of the RSET pin
5	EN	Device enable (active high)
6	VOUT	Charge pump output connected to the LED anodes
7	VIN	Supply voltage
8	C1+	Bucket capacitor 1 terminal
9	C1-	Bucket capacitor 1 terminal
10	C2-	Bucket capacitor 2 terminal
11	C2+	Bucket capacitor 2 terminal
12	GND	Ground Reference
	TAB	Connect to GND on the PCB

Note:

(1) LED1, LED2, LED3 pins should not be left floating. They should be connected to the LED cathode, or tied to VOUT pin if not used.

PIN FUNCTION

VIN is the supply pin for the charge pump. A small 1 μ F ceramic bypass capacitor is required between the VIN pin and ground near the device. The operating input voltage range is from 3.0V to 5.5V.

EN is the enable control logic input for all LED channels. Guaranteed levels of logic high and logic low are set at 1.3V and 0.4V respectively.

RSET pin is regulated at 1.2V. An external resistor RSET connected from the RSET pin to GND sets the LED current.

VOUT is the charge pump output that is connected to the LED anodes. A small 1 μ F ceramic bypass capacitor is required between the VOUT pin and ground near the device.

GND is the ground reference for the charge pump. The pin must be connected to the ground plane on the PCB.

C1+, C1- are connected to each side of the 1 μ F ceramic bucket capacitor C1.

C2+, C2- are connected to each side of the 1 μ F ceramic bucket capacitor C2.

LED1 to LED3 provide the internal regulated current for each of the LED cathodes. These pins enter a high impedance, zero current state whenever the device is placed in shutdown mode. In applications using less than three LEDs, all unused channels should be wired directly to VOUT. This ensures the channel is automatically disabled dissipating less than 200 μ A.

TAB is the exposed pad underneath the package. For best thermal performance, the tab should be soldered to the PCB and connected to the ground plane.

BLOCK DIAGRAM

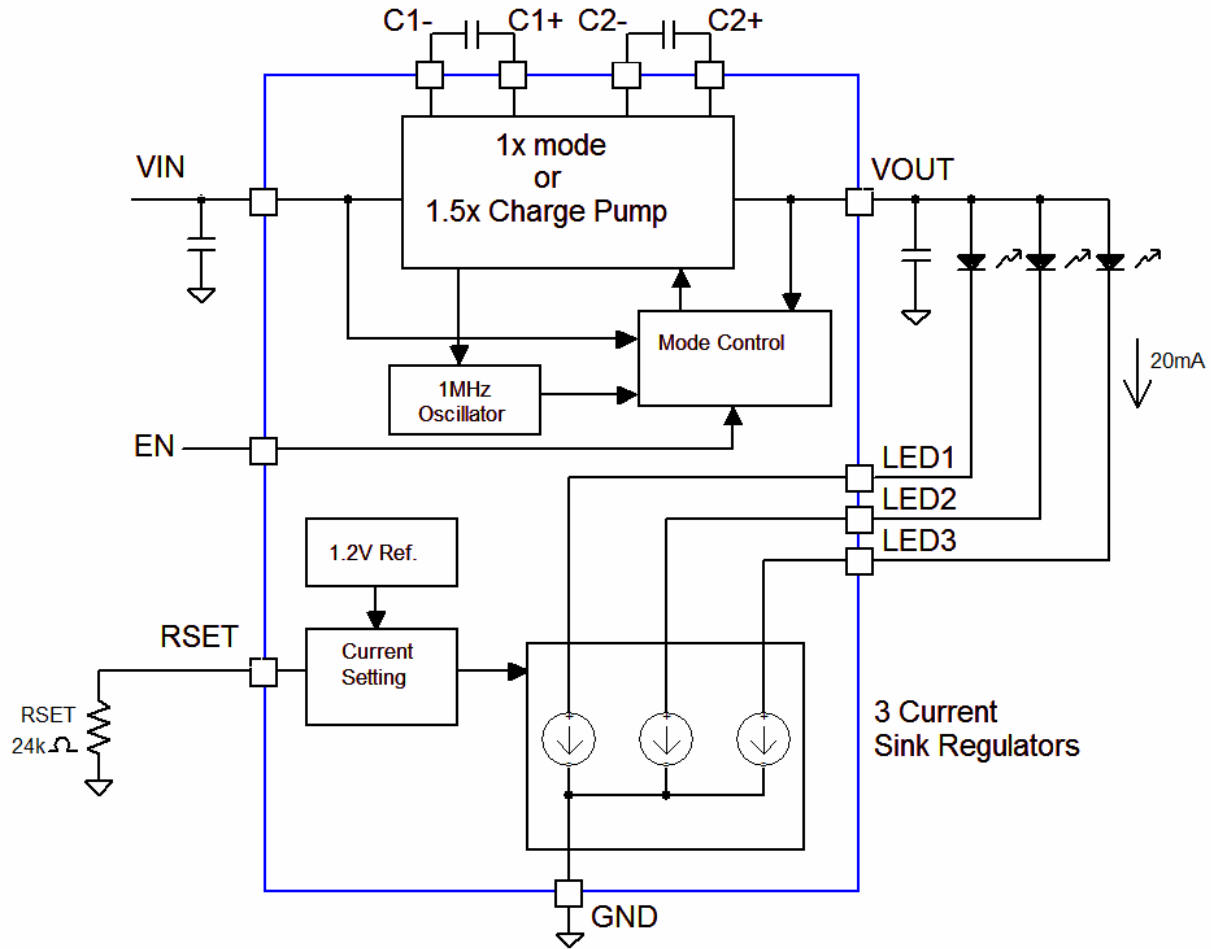

Figure 2. CAT3603 Functional Block Diagram

BASIC OPERATION

At power-up, the CAT3603 starts operating in 1x mode where the output will be approximately equal to the input supply voltage (minus any internal voltage losses). If the output voltage is sufficient to regulate all LED currents, the device remains in 1x operating mode.

If the input voltage falls to a level where the regulated currents cannot be maintained, the device automatically switches into 1.5x mode.

In 1.5x mode, the output is approximately equal to 1.5 times the input supply voltage (minus any internal voltage losses), and high enough to achieve the nominal LED current.

The above sequence is reinitialized every time the chip is powered-up or is taken out of shutdown mode (via EN pin).

LED CURRENT SETTING

The LED current is set by the external resistor R_{SET} connected between the RSET pin and ground. Table 1 lists various LED currents and the associated R_{SET} resistor value for standard 1% precision surface mount resistors.

Table 1. RSET Resistor Selection

LED Current (mA)	R_{SET} (k Ω)
1	649
5	287
10	102
15	49.9
20	32.4
25	23.7
30	15.4

The unused LED channels must be disabled by connecting the respective LED pins to VOUT. A disabled channel sinks only 0.2mA typical. When the following equation is true on any channel, the driver turns off the LED channel:

$$V_{OUT} - V_{LED} \leq 1V \text{ (LED channel OFF)}$$

Note: The CAT3603 is designed to drive LEDs with forward voltage greater than 1V and is not compatible with resistive loads less than 5k Ω .

External Components

The driver requires a total of four external 1 μ F ceramic capacitors: two for decoupling input and output, and two for the charge pump. Both capacitor types X5R and X7R are recommended for the LED driver application. In the 1.5x charge pump mode, the input current ripple

is kept very low by design, and an input bypass capacitor of 1 μ F is sufficient. In 1x mode, the device operating in linear mode does not introduce switching noise back onto the supply.

Recommended Layout

In 1.5x charge pump mode, the driver switches internally at a high frequency of 1MHz. It is recommended to minimize trace length to all four capacitors. A ground plane should cover the area under the driver IC as well as the bypass capacitors. Short connection to ground on capacitors CIN and COUT can be implemented with the use of multiple via. A copper area matching the TDFN exposed pad (GND) must be connected to the ground plane underneath. The use of multiple via improves the package heat dissipation.

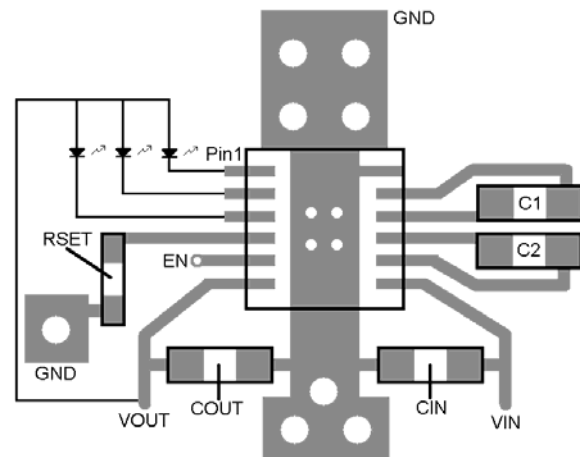
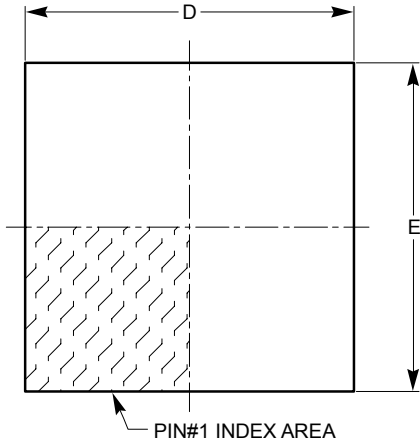

Figure 3. Recommended Layout

CAT3603

PACKAGE OUTLINE DRAWING

TDFN 12-Pad 3 x 3mm (HV2) ⁽¹⁾⁽²⁾



TOP VIEW

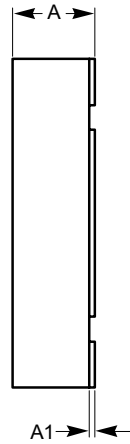

SIDE VIEW

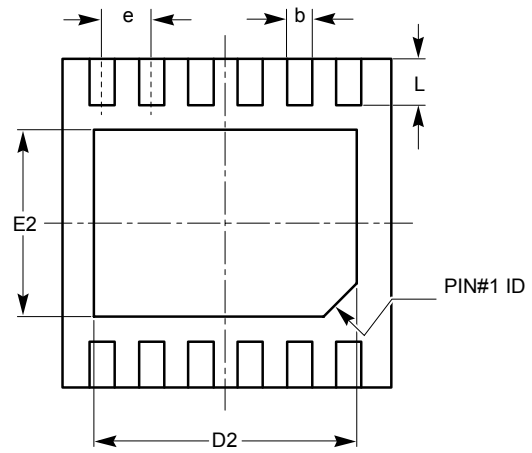

BOTTOM VIEW

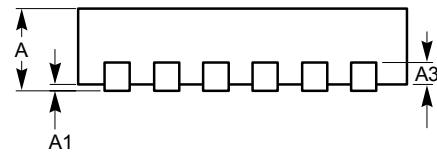

FRONT VIEW

SYMBOL	MIN	NOM	MAX
A	0.70	0.75	0.80
A1	0.00	0.02	0.05
A3	0.178	0.203	0.228
b	0.18	0.23	0.30
D	2.90	3.00	3.10
D2	2.30	2.40	2.50
E	2.90	3.00	3.10
E2	1.55	1.70	1.75
e	0.45 BSC		
L	0.30	0.40	0.50
M	0.25	0.30	0.35
N	0.60	0.70	0.80
P	2.70	3.00	3.10
R	2.25 TYP		

RECOMMENDED LAND PATTERN

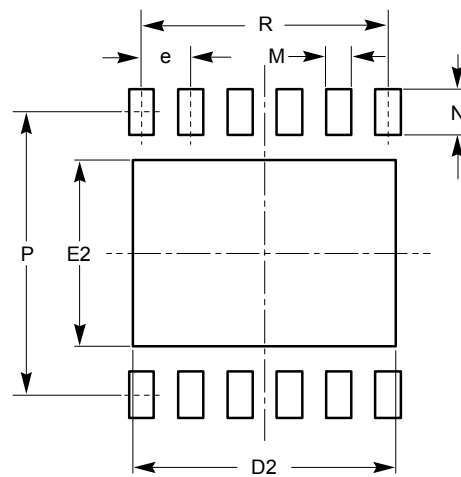

Notes:

- (1) All dimensions are in millimeters.
- (2) Complies with JEDEC standard MO-229.

EXAMPLE OF ORDERING INFORMATION ⁽¹⁾⁽²⁾

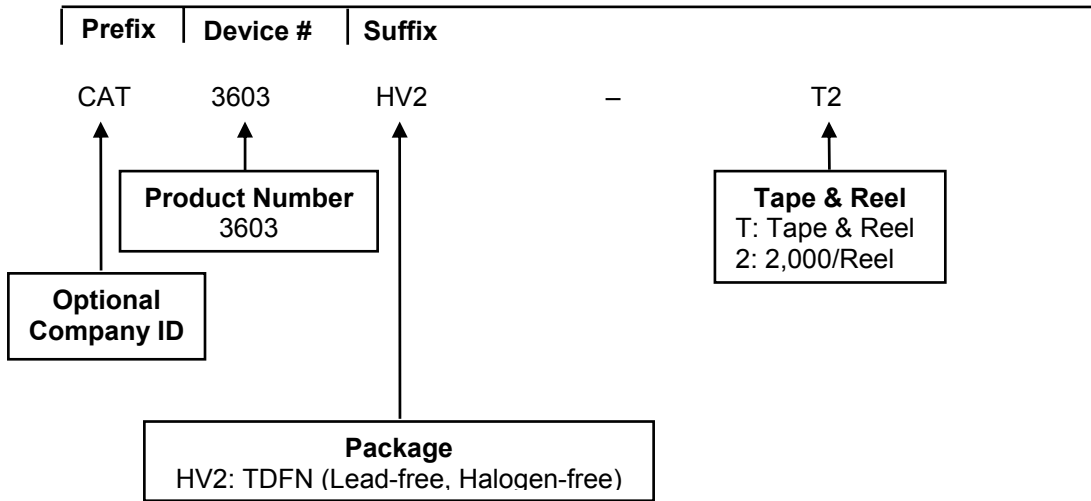

Notes:

- (1) All packages are RoHS-compliant (Lead-free, Halogen-free).
- (2) The standard lead finish is Matte-Tin.
- (3) The device used in the above example is a CAT3603HV2 –T2 (TDFN, Tape & Reel, 2,000/Reel).
- (4) For additional package and temperature options, please contact your nearest Catalyst Semiconductor Sales office.

REVISION HISTORY

Date	Revision	Description
28-May-06	A	Initial Issue
03-Jun-06	B	Update Description Update Recommended Operating Conditions
10-Jul-06	C	Update Pin Configuration Update Pin Description
17-Jul-08	D	Update Recommended Operating Conditions table Update Package Outline Drawing Add MD- to the document number

Copyrights, Trademarks and Patents

© Catalyst Semiconductor, Inc.

Trademarks and registered trademarks of Catalyst Semiconductor include each of the following:

Adaptive Analog™, Beyond Memory™, DPP™, EZDim™, LDD™, MiniPot™, Quad-Mode™ and Quantum Charge Programmable™

Catalyst Semiconductor has been issued U.S. and foreign patents and has patent applications pending that protect its products.

CATALYST SEMICONDUCTOR MAKES NO WARRANTY, REPRESENTATION OR GUARANTEE, EXPRESS OR IMPLIED, REGARDING THE SUITABILITY OF ITS PRODUCTS FOR ANY PARTICULAR PURPOSE, NOR THAT THE USE OF ITS PRODUCTS WILL NOT INFRINGE ITS INTELLECTUAL PROPERTY RIGHTS OR THE RIGHTS OF THIRD PARTIES WITH RESPECT TO ANY PARTICULAR USE OR APPLICATION AND SPECIFICALLY DISCLAIMS ANY AND ALL LIABILITY ARISING OUT OF ANY SUCH USE OR APPLICATION, INCLUDING BUT NOT LIMITED TO, CONSEQUENTIAL OR INCIDENTAL DAMAGES.

Catalyst Semiconductor products are not designed, intended, or authorized for use as components in systems intended for surgical implant into the body, or other applications intended to support or sustain life, or for any other application in which the failure of the Catalyst Semiconductor product could create a situation where personal injury or death may occur.

Catalyst Semiconductor reserves the right to make changes to or discontinue any product or service described herein without notice. Products with data sheets labeled "Advance Information" or "Preliminary" and other products described herein may not be in production or offered for sale.

Catalyst Semiconductor advises customers to obtain the current version of the relevant product information before placing orders. Circuit diagrams illustrate typical semiconductor applications and may not be complete.



Catalyst Semiconductor, Inc.
Corporate Headquarters
2975 Stender Way
Santa Clara, CA 95054
Phone: 408.542.1000
Fax: 408.542.1200
0Hwww.catsemi.com

Document No: MD-5017
Revision: D
Issue date: 07/17/08