



6-Channel LED Driver with I²C™ Interface

FEATURES

- Drives 6 LED channels
- Independent current on 3 pairs of LEDs
- I²C serial interface programming
- Adjustable current to 32mA in 0.5mA step
- Power efficiency up to 91%
- Fractional pump 1x/1.5x
- Low noise input ripple
- Fixed High Frequency Operation 1MHz
- “Zero” Current Shutdown Mode
- Soft start and current limiting
- Short circuit protection
- Thermal shutdown protection

APPLICATIONS

- RGB LEDs
- LCD and keypad Backlighting
- Cellular Phones, PDAs
- Digital Cameras

ORDERING INFORMATION

Part Number	Package	Quantity per Reel	Package Marking
CAT3626HV4-T2	TQFN-16 ⁽¹⁾	2000	G626
CAT3626HV4-GT2	TQFN-16 ⁽²⁾	2000	CDAJ

Notes: (1) Matte-Tin Plated Finish (RoHS-compliant)
(2) NiPdAu Plated Finish (RoHS-compliant)

PIN CONFIGURATION

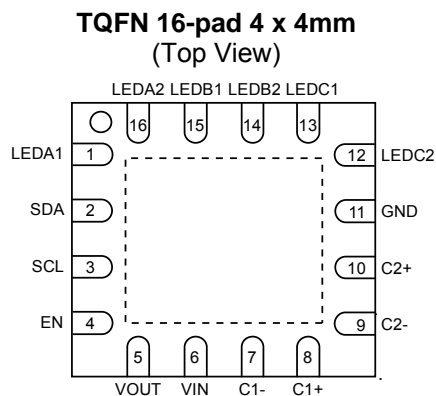

PRODUCT DESCRIPTION

The CAT3626 is a high efficiency 1x/1.5x fractional charge pump with programmable dimming current in six LED channels. To ensure uniform brightness in LCD backlight applications, each LED channel delivers an accurate regulated current.

Low noise and input ripple is achieved by operating at a constant switching frequency of 1MHz which allows the use of small external ceramic capacitors. The 1x/1.5x fractional charge pump supports a wide range of input voltages from 3V to 5.5V with efficiency up to 91%, and is ideal for Li-Ion battery powered devices.

The LED channels are configured into three independent pairs, each containing 2 matched channels. Each pair can be separately programmed from zero to 32mA, in 0.5mA resolution steps, using the I²C serial interface. Any individual channel can be disabled while others remain active. When the enable input (EN) is low, the device is in shutdown mode drawing zero current.

The device is available in a 16-pad TQFN package with a max height of 0.8mm.

For Ordering Information details, see page 14.

TYPICAL APPLICATION CIRCUIT

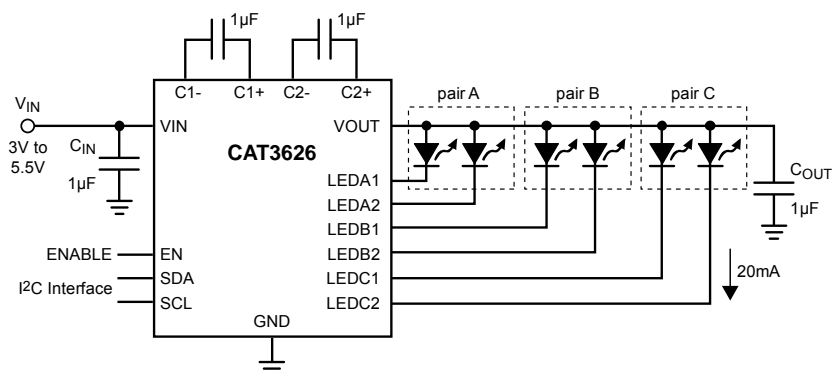

I²C is a trademark of Philips Corporation. Catalyst Semiconductor is licensed by Philips Corporation to carry the I²C bus protocol.

ABSOLUTE MAXIMUM RATINGS

Parameters	Ratings	Units
V _{IN} , LEDxx voltage	6	V
V _{OUT} , C1±, C2± voltage	7	V
EN, SDA, SCL voltage	V _{IN} + 0.7V	V
Storage Temperature Range	-65 to +160	°C
Junction Temperature Range	-40 to +150	°C
Lead Temperature	300	°C

RECOMMENDED OPERATING CONDITIONS

Parameter	Range	Units
V _{IN}	3 to 5.5	V
Ambient Temperature Range	-40 to +85	°C
LED forward voltage	Up to 4.2	V
I _{LED} per LED pin	0 to 32	mA

Typical application circuit with external components is shown on page 1.

ELECTRICAL OPERATING CHARACTERISTICS

V_{IN} = 3.6V, EN = High, ambient temperature of 25°C (over recommended operating conditions unless specified otherwise)

Symbol	Parameter	Test Conditions	Min	Typ	Max	Units
I _Q	Quiescent Current	1x mode, all LEDs Off		0.5		mA
		1x mode, all LEDs On		2.2		mA
		1.5x mode, all LEDs Off		3.5		mA
I _{QSHDN}	Shutdown Current	V _{EN} = 0V		0	1	µA
I _{LED}	LED Current Range with 6 LEDs		0		32	mA
I _{LED-ACC}	LED Current Accuracy	1mA ≤ I _{LED} ≤ 31mA		±3		%
I _{LED-DEV}	LED Channel Matching	(I _{LED} - I _{LEDAVG}) / I _{LEDAVG}		±3		%
R _{OUT}	Output Resistance (open loop)	1x mode, I _{OUT} = 120mA		0.5		Ω
		1.5x mode, I _{OUT} = 120mA		2.8		Ω
F _{OSC}	Charge Pump Frequency		0.8	1	1.3	MHz
I _{SC_MAX}	Output short circuit Current Limit	V _{OUT} < 0.5V		60		mA
I _{IN_MAX}	Input Current Limit	1x mode, V _{OUT} > 1V		300		mA
I _{EN} V _{HI-EN} V _{LO-EN}	EN Pin - Input Leakage - Logic High Level - Logic Low Level		-1		1	µA
			1.3		0.4	V
						V
V _{HI} V _{LO}	I ² C SDA, SCL - High Level Input Voltage - Low Level Input Voltage		0.7 x V _{IN}		0.3 x V _{IN}	V
						V
T _{SD}	Thermal Shutdown			165		°C
T _{HYS}	Thermal Hysteresis			20		°C
V _{UVLO}	Under-voltage lock out (UVLO) threshold			2		V

A.C. CHARACTERISTICS

For $3V \leq V_{IN} \leq 5.5V$, over full ambient temperature range -40 to $+125^{\circ}C$ (over recommended operating conditions unless specified otherwise).

Symbol	Parameter	Min	Typ	Max	Unit
f_{SCL}	Clock Frequency			400	kHz
t_{AA}	SCL Low to SDA Data Out and ACK Out			0.9	μs
t_{BUF}	Bus Free Time Before a New Transmission Can Start	1.2			μs
$t_{HD:STA}$	Start Condition Hold Time	0.6			μs
t_{LOW}	Clock Low Period	1.2			μs
t_{HIGH}	Clock High Period	0.6			μs
$t_{SU:STA}$	Start Condition Setup Time (For a Repeated Condition)	0.6			μs
$t_{HD:DAT}$	Data In Hold Time	0			ns
$t_{SU:DAT}$	Data In Setup Time	100			ns
t_R	SDA and SCL Rise Time			0.3	μs
t_F	SDA and SCL Fall Time			300	ns
$t_{SU:STO}$	Stop Condition Setup Time	0.6			μs
t_{DH}	Data Out Hold Time	50			ns

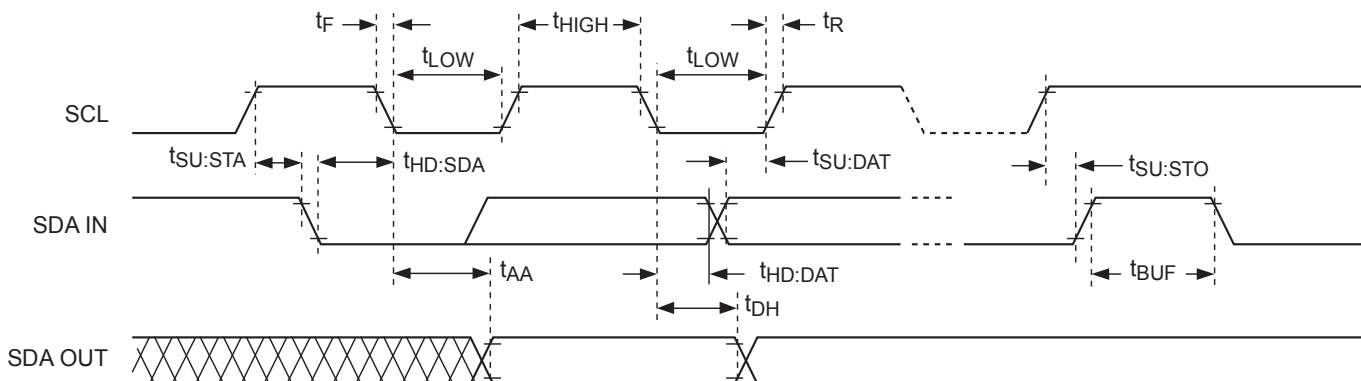

Figure 1. I²C Bus Timing Characteristics

CAT3626

TYPICAL CHARACTERISTICS

$V_{IN} = 3.6V$, $I_{OUT} = 90mA$ (6 LEDs at 15mA), $EN = V_{IN}$, $C_{IN} = C_1 = C_2 = C_{OUT} = 1\mu F$, $T_{AMB} = 25^{\circ}C$, unless otherwise specified.

Efficiency vs. Supply Voltage (6 LEDs)

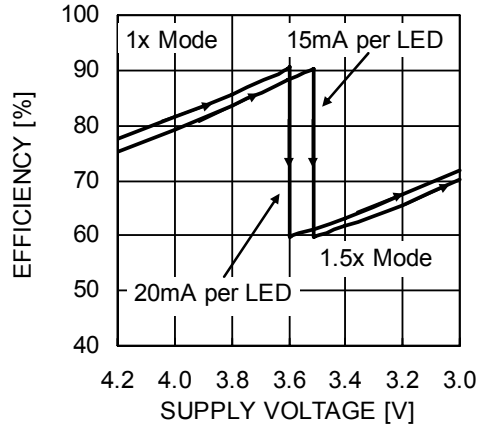

Efficiency vs. Total LED Current (6 LEDs)

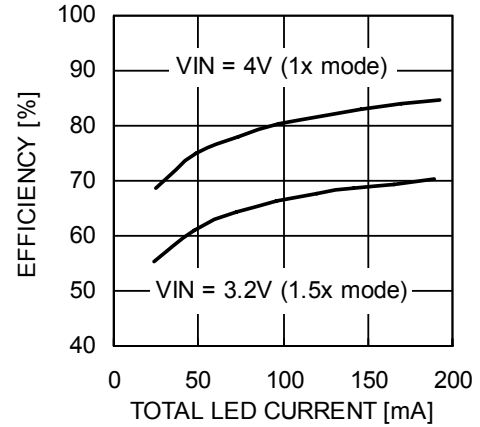

Quiescent Current vs. Supply Voltage (1x Mode)

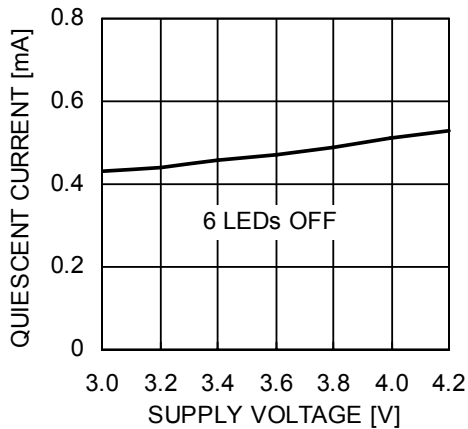

Quiescent Current vs. Temperature (1x Mode)

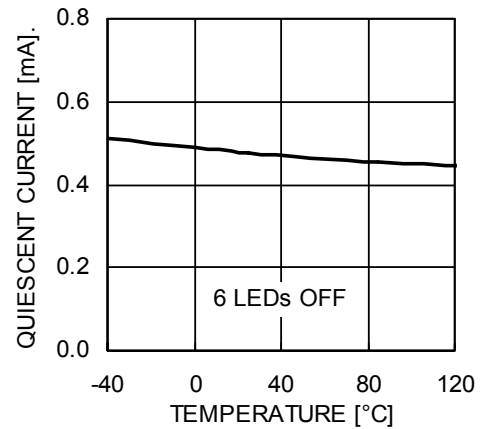

Quiescent Current vs. Supply Voltage (1.5x Mode)

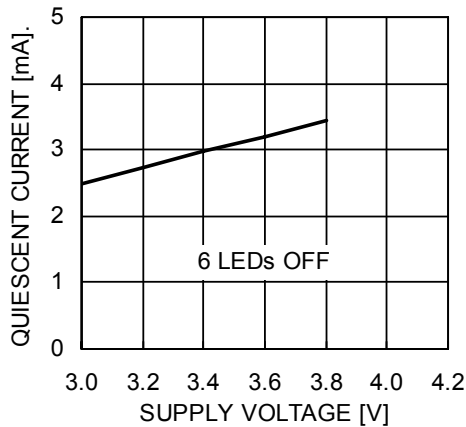

Quiescent Current vs. Temperature (1.5x Mode)

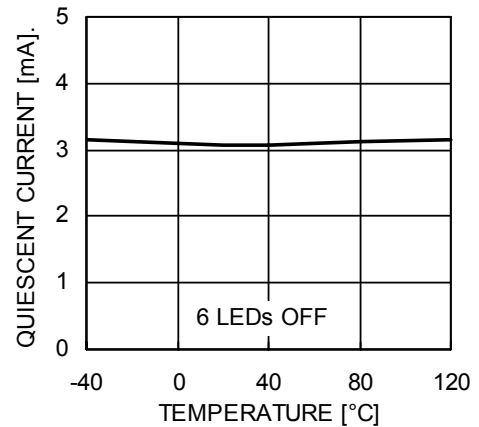

TYPICAL CHARACTERISTICS

$V_{IN} = 3.6V$, $I_{OUT} = 90mA$ (6 LEDs at 15mA), $EN = V_{IN}$, $C_{IN} = C_1 = C_2 = C_{OUT} = 1\mu F$, $T_{AMB} = 25^{\circ}C$, unless otherwise specified.

LED Current Change vs. Supply Voltage

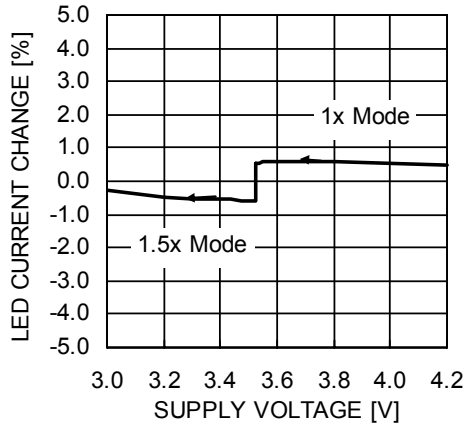

LED Current Change vs. Temperature

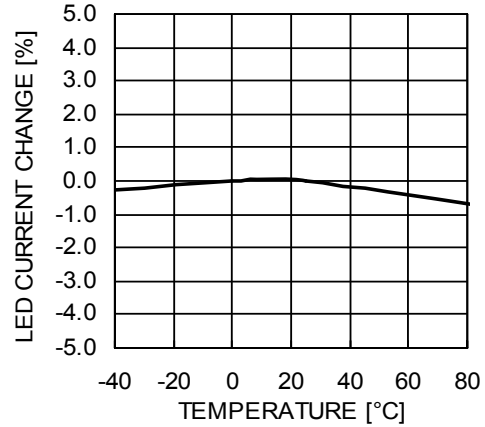

Switching Frequency vs. Supply Voltage

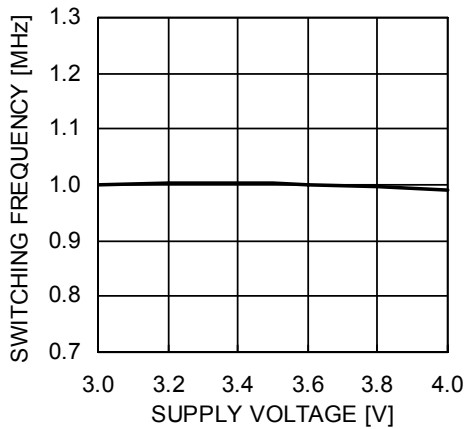

Switching Frequency vs. Temperature

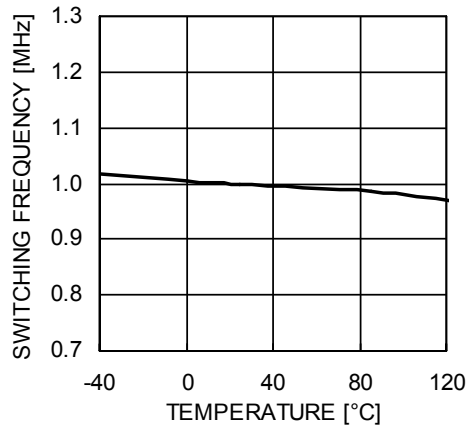

Output Resistance vs. Supply Voltage (1x Mode)

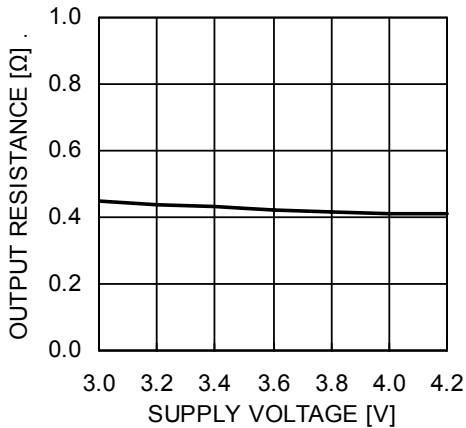

Output Resistance vs. Supply Voltage (1.5x Mode)

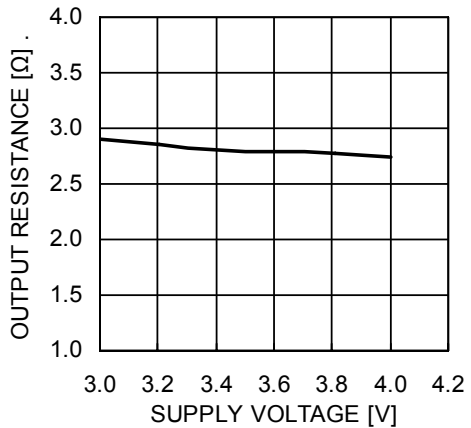

CAT3626

TYPICAL CHARACTERISTICS

$V_{IN} = 3.6V$, $I_{OUT} = 90mA$ (6 LEDs at 15mA), $EN = V_{IN}$, $C_{IN} = C_1 = C_2 = C_{OUT} = 1\mu F$, $T_{AMB} = 25^{\circ}C$, unless otherwise specified.

Power Up with 6 LEDs at 15mA (1x Mode)

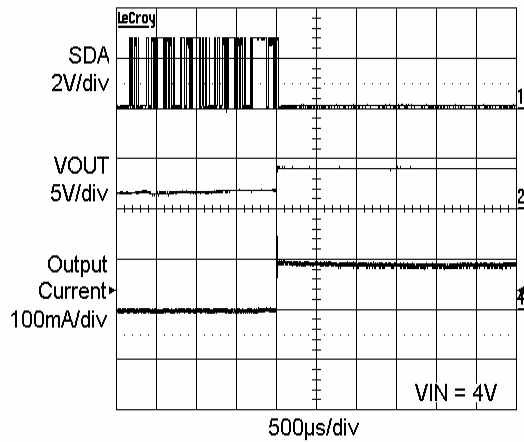

Power Up with 6 LEDs at 15mA (1.5x Mode)

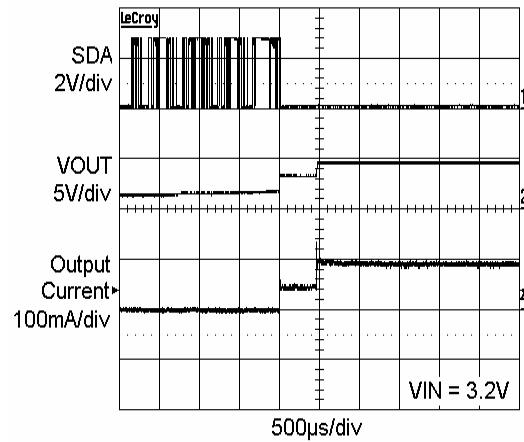

Enable Power Down (1x Mode)

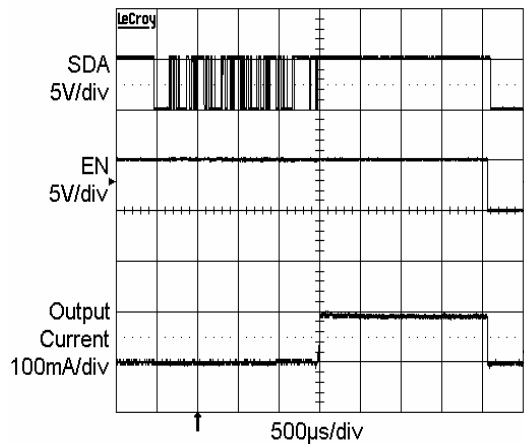

Enable Power Down (1.5x Mode)

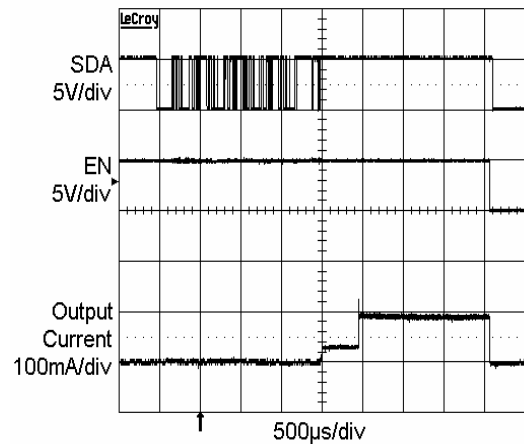

Switching Waveforms in 1.5x Mode

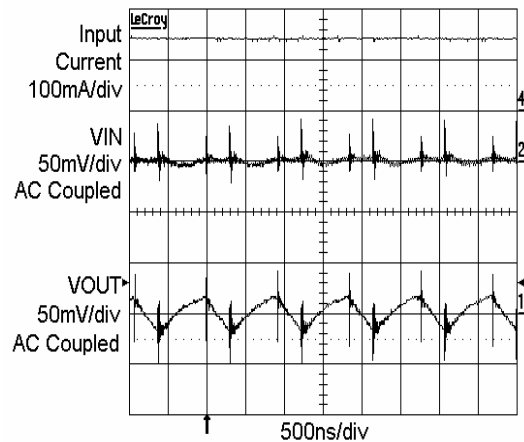

Operating Waveforms in 1x Mode

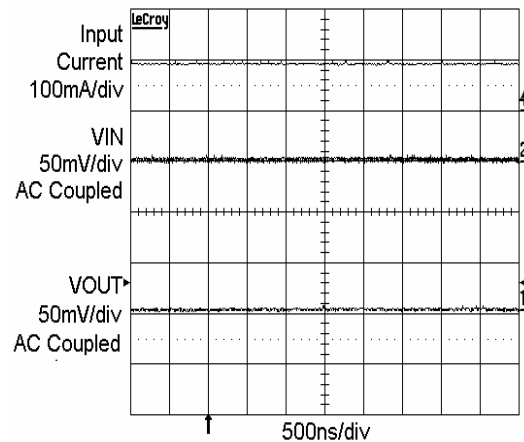

TYPICAL CHARACTERISTICS

$V_{IN} = 3.6V$, $I_{OUT} = 90mA$ (6 LEDs at 15mA), $EN = V_{IN}$, $C_{IN} = C_1 = C_2 = C_{OUT} = 1\mu F$, $T_{AMB} = 25^{\circ}C$, unless otherwise specified.

Line Transient Response in 1x mode

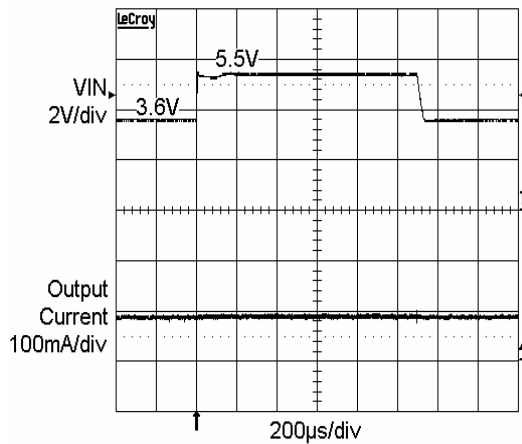

Foldback Current Limit

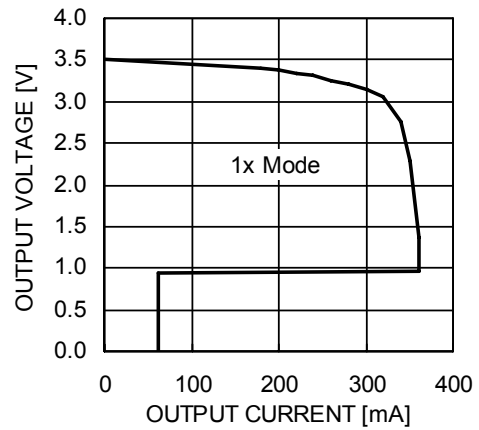

SDA, SCL V_{IH} vs. Supply Voltage

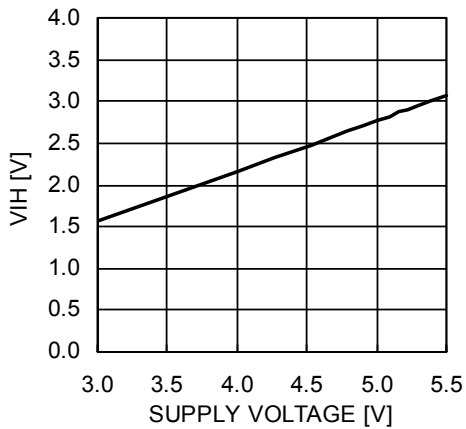

SDA, SCL V_{IL} vs. Supply Voltage

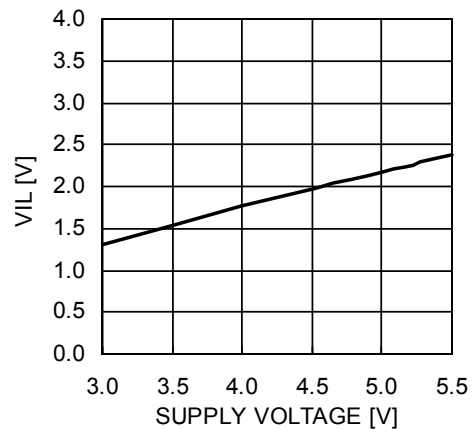

PIN DESCRIPTIONS

Pin #	Name	Function
1	LEDA1	Cathode terminal of LED A1
2	SDA	I ² C Serial data input/output
3	SCL	I ² C Serial clock input
4	EN	Enable input
5	VOUT	Charge pump output connected to the LED anodes
6	VIN	Supply voltage
7	C1-	Bucket capacitor 1 terminal
8	C1+	Bucket capacitor 1 terminal
9	C2-	Bucket capacitor 2 terminal
10	C2+	Bucket capacitor 2 terminal
11	GND	Ground reference
12	LEDC2	Cathode terminal of LED C2
13	LEDC1	Cathode terminal of LED C1
14	LEDB2	Cathode terminal of LED B2
15	LEDB1	Cathode terminal of LED B1
16	LEDA2	Cathode terminal of LED A2
	TAB	Connect to Ground on PCB

PIN FUNCTION

VIN is the supply pin for the charge pump. A small 1 μ F ceramic bypass capacitor is required between the VIN pin and ground near the device. The operating input voltage range is from 2.2V to 5.5V. Whenever the input supply falls below the undervoltage threshold (2V), all LEDs channels will be automatically disabled.

EN is the enable logic input for the driver. Guaranteed levels of logic high and logic low are set at 1.3V and 0.4V respectively. When EN is initially taken high, the device becomes enabled and all LED currents remain at 0mA. To place the device into zero current shutdown mode, the EN pin must be held low.

SDA is the I²C serial data line. This is a bidirectional line allowing data to be written into and read from the four registers in the driver. Registers RegA/B/C set the LED current in each pair of channels, while RegEn sets the On/Off state independently of each channel.

SCL is the I²C serial clock input.

VOUT is the charge pump output that is connected to the LED anodes. A small 1 μ F ceramic bypass capacitor is required between the VOUT pin and ground near the device.

GND is the ground reference for the charge pump. The pin must be connected to the ground plane on the PCB.

C1+, C1- are connected to each side of the 1 μ F ceramic bucket capacitor C1.

C2+, C2- are connected to each side of the 1 μ F ceramic bucket capacitor C2.

LEDxx provide the internally regulated current to the six LED cathodes. These pins enter a high-impedance zero-current state whenever the device is placed in shutdown mode. In applications using less than six LEDs, the unused channels should be disabled through the RegEn register.

TAB is the exposed pad underneath the package. For best thermal performance, the tab should be soldered to the PCB and connected to the ground plane.

BLOCK DIAGRAM

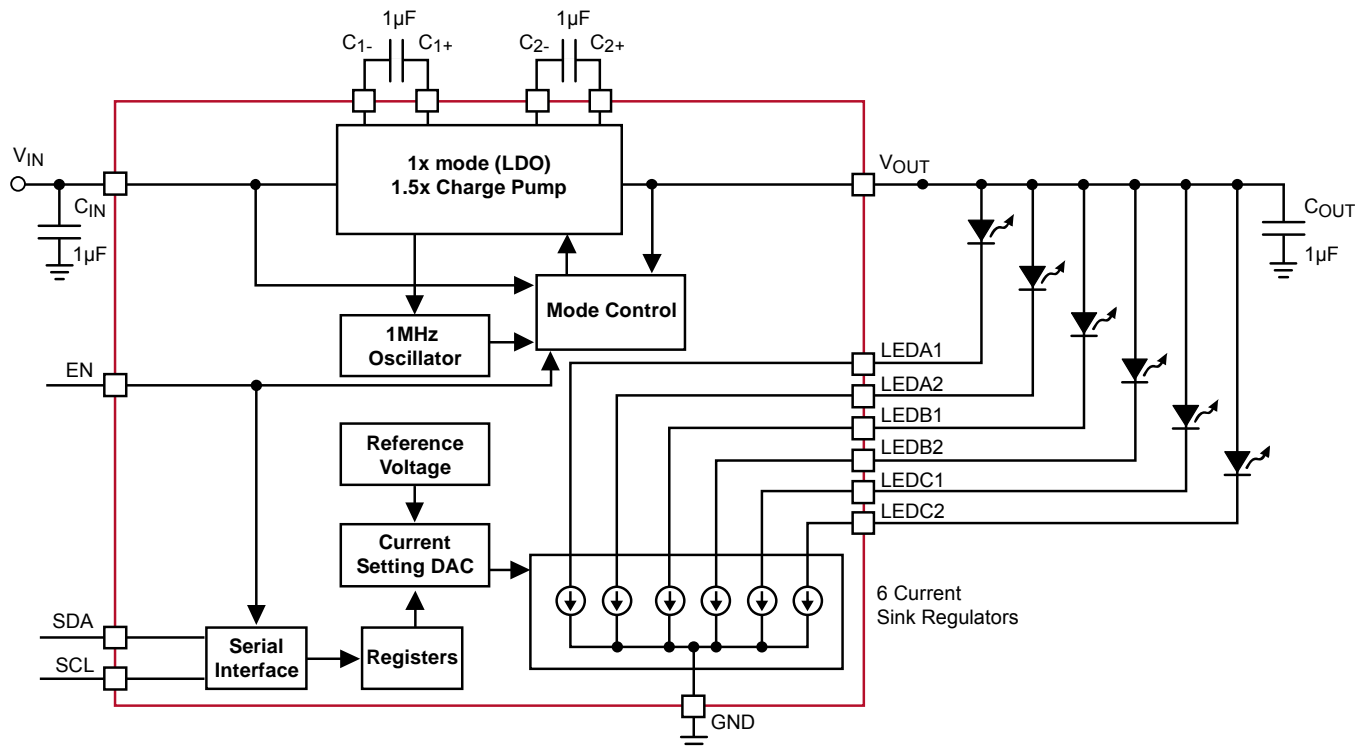

Figure 2. CAT3626 Functional Block Diagram

BASIC OPERATION

At power-up, the CAT3626 starts operating in 1x mode where the output will be approximately equal to the input supply voltage (less any internal voltage losses). If the output voltage is sufficient to regulate all LEDs currents the device remains in 1x operating mode.

If the input voltage is insufficient or falls to a level where the regulated currents cannot be maintained, the device automatically switches (after a fixed time of 400µs) into 1.5x mode.

In 1.5x mode, the output is approximately equal to 1.5 times the input supply voltage (less any internal voltage losses).

The above sequence is repeated each and every time the chip is either powered-up or taken out of shutdown (via EN pin), or the RegEn register is accessed by write cycle.

LED CURRENT SETTING

The LED current setting is programmed via the I²C serial interface and is stored in four

8-bit registers RegA, RegB, RegC and RegEn as follows:

- RegA stores the LED current for group A (LEDA1 and LEDA2 channels),
- RegB stores the LED current for group B (LEDB1 and LEDB2 channels),
- RegC stores the LED current for group C (LEDC1 and LEDC2 channels),
- RegEn selects the on/off state of each of the 6 LED channels.

At each write access to RegEn, the driver automatically reconfigures to the mode (1x or 1.5x) that provides the highest efficiency.

CAT3626
Table 1. Register address and data configuration⁽¹⁾

Register name	Register Address	Bit pattern							
		Bit 7	Bit 6	Bit 5	Bit 4	Bit 3	Bit 2	Bit 1	Bit 0
RegA	0	X	X	See Table 2 for values					
RegB	1	X	X						
RegC	2	X	X						
RegEn	3	X	X	LEDC2 On = 1 Off = 0	LEDC1 On = 1 Off = 0	LEDB2 On = 1 Off = 0	LEDB1 On = 1 Off = 0	LEDA2 On = 1 Off = 0	LEDA1 On = 1 Off = 0

The table 2 lists the various LED currents with the associated RegA, RegB, and RegC register values.

Table 2. LED Current Selection and Register Value⁽¹⁾

LED current (mA)	D7	D6	D5	D4	D3	D2	D1	D0	Dec
0.5	X	X	0	0	0	0	0	0	0
1.0	X	X	0	0	0	0	0	1	1
1.5	X	X	0	0	0	0	1	0	2
2.0	X	X	0	0	0	0	1	1	3
2.5	X	X	0	0	0	1	0	0	4
3.0	X	X	0	0	0	1	0	1	5
3.5	X	X	0	0	0	1	1	0	6
4.0	X	X	0	0	0	1	1	1	7
4.5	X	X	0	0	1	0	0	0	8
5.0	X	X	0	0	1	0	0	1	9
5.5	X	X	0	0	1	0	1	0	10
6.0	X	X	0	0	1	0	1	1	11
6.5	X	X	0	0	1	1	0	0	12
7.0	X	X	0	0	1	1	0	1	13
7.5	X	X	0	0	1	1	1	0	14
8.0	X	X	0	0	1	1	1	1	15
8.5	X	X	0	1	0	0	0	0	16
9.0	X	X	0	1	0	0	0	1	17
9.5	X	X	0	1	0	0	1	0	18
10.0	X	X	0	1	0	0	1	1	19
10.5	X	X	0	1	0	1	0	0	20
11.0	X	X	0	1	0	1	0	1	21
11.5	X	X	0	1	0	1	1	0	22
12.0	X	X	0	1	0	1	1	1	23
12.5	X	X	0	1	1	0	0	0	24
13.0	X	X	0	1	1	0	0	1	25
13.5	X	X	0	1	1	0	1	0	26
14.0	X	X	0	1	1	0	1	1	27
14.5	X	X	0	1	1	1	0	0	28
15.0	X	X	0	1	1	1	0	1	29
15.5	X	X	0	1	1	1	1	0	30
16.0	X	X	0	1	1	1	1	1	31
16.5	X	X	1	0	0	0	0	0	32
17.0	X	X	1	0	0	0	0	1	33
17.5	X	X	1	0	0	0	1	0	34
18.0	X	X	1	0	0	0	1	1	35
18.5	X	X	1	0	0	1	0	0	36
19.0	X	X	1	0	0	1	0	1	37
19.5	X	X	1	0	0	1	1	0	38
20.0	X	X	1	0	0	1	1	1	39
20.5	X	X	1	0	1	0	0	0	40
21.0	X	X	1	0	1	0	0	1	41
21.5	X	X	1	0	1	0	1	0	42
22.0	X	X	1	0	1	0	1	1	43
22.5	X	X	1	0	1	1	0	0	44
23.0	X	X	1	0	1	1	0	1	45
23.5	X	X	1	0	1	1	1	0	46
24.0	X	X	1	0	1	1	1	1	47
24.5	X	X	1	1	0	0	0	0	48
25.0	X	X	1	1	0	0	0	1	49
25.5	X	X	1	1	0	0	1	0	50
26.0	X	X	1	1	0	0	1	1	51
26.5	X	X	1	1	0	1	0	0	52
27.0	X	X	1	1	0	1	0	1	53
27.5	X	X	1	1	0	1	1	0	54
28.0	X	X	1	1	0	1	1	1	55
28.5	X	X	1	1	1	0	0	0	56
29.0	X	X	1	1	1	0	0	1	57
29.5	X	X	1	1	1	0	1	0	58
30.0	X	X	1	1	1	0	1	1	59
30.5	X	X	1	1	1	1	0	0	60
31.0	X	X	1	1	1	1	0	1	61
31.5	X	X	1	1	1	1	1	0	62
32.0	X	X	1	1	1	1	1	1	63

Notes:

- (1) X = not used
 1 = logic high
 0 = logic low

I²C INTERFACE

The LED driver is interfaced through a 2-wire serial I²C-bus in order to control the state and the current in each of the six LED channels. The SDA and SCL lines comply with the I²C electrical specification and should be terminated with pull-up resistors. When the bus is not used, both lines are high. The device supports the maximum bus speed of 400kbit/s. The serial bit sequence is shown below for read and write operations into the registers. Read and write instructions are

initiated by the master controller/CPU and acknowledged by the slave LED driver. The I²C address of the driver is internally fixed to the binary value 1100110. The protocol requires that the start bit and the device address are both repeated. For further details on the I²C protocol, please refer to the I²C-Bus Specification, document number 9398 393 40011, from Philips Semiconductors.

- Read operation:



- Write operation:

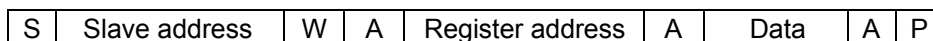

S: Start condition

R, W: Read bit (1), Write bit (0)

A: Acknowledge sent by the slave LED driver (SDA high)

A*: Not Acknowledge sent by the master microcontroller (SDA low)

P: Stop condition

Slave address: Device address 7 bits (MSB first, slave address is 1100110).

Register address: Device register address 8 bits

Data: Data to read or write 8 bits

Write Instruction Sequence

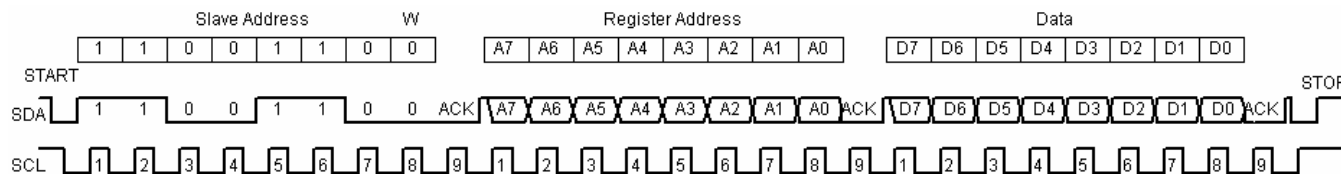

Write Instruction Example setting 20mA current in LEDB1 and LEDB2

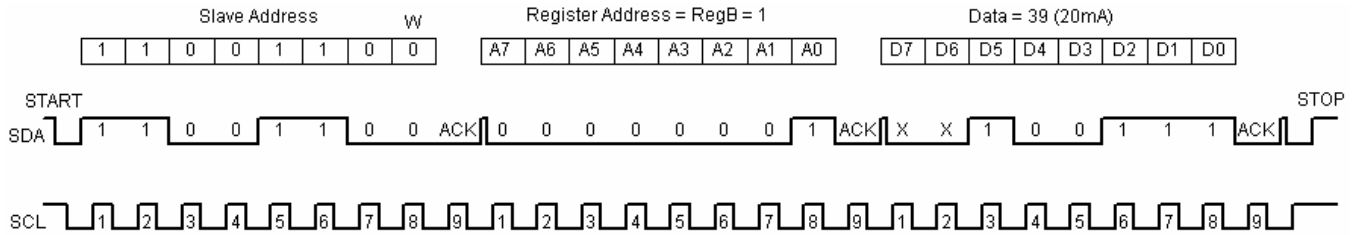

I²C Bus Protocol

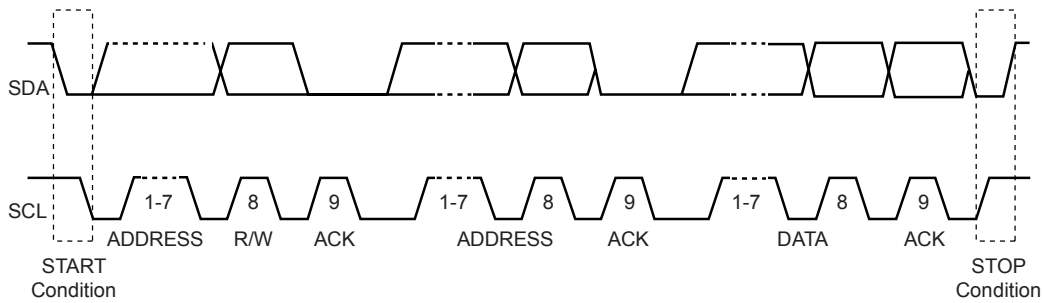

TYPICAL APPLICATION

The CAT3626 is ideal for driving RGB (red green blue) LEDs with common anode configuration. The individual LED currents associated with the red, green and blue LEDs are programmable independently through the I²C interface, allowing to generate an accurate color

mixing. Dimming while maintaining the same color can be done by reprogramming the RegEn register on and off with the appropriate duty cycle (PWM mode).

RGB LED

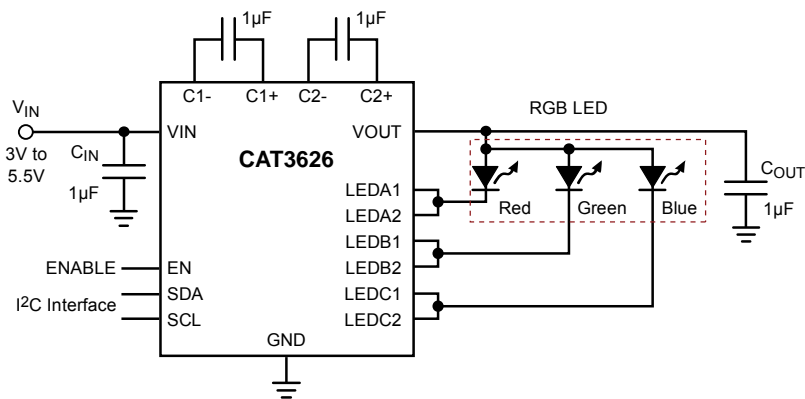

PACKAGE OUTLINE DRAWING

TQFN 16-Pad 4 x 4mm (HV4) ⁽¹⁾⁽²⁾

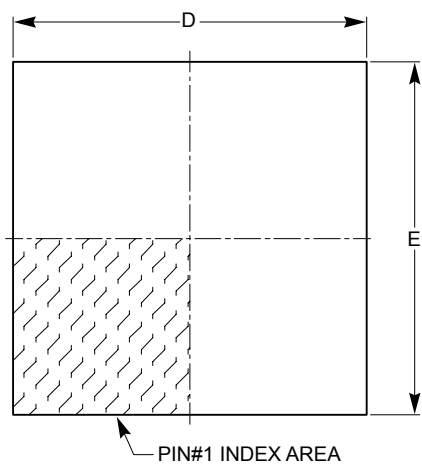

TOP VIEW

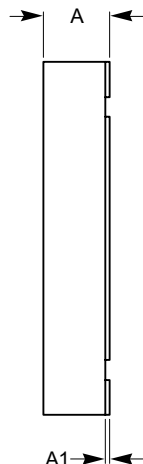

SIDE VIEW

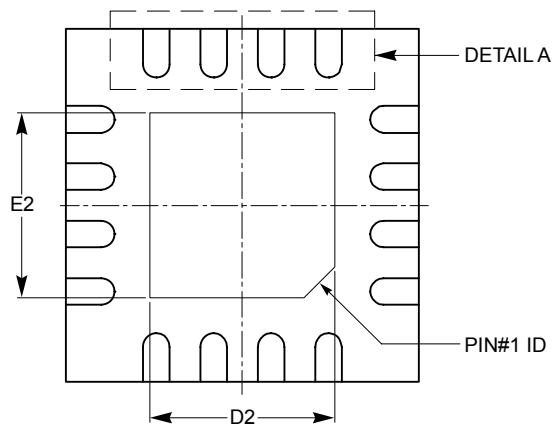

BOTTOM VIEW

SYMBOL	MIN	NOM	MAX
A	0.70	0.75	0.80
A1	0.00	0.02	0.05
A3	0.20 REF		
b	0.25	0.30	0.35
D	3.90	4.00	4.10
D2	2.00	–	2.25
E	3.90	4.00	4.10
E2	2.00	–	2.25
e	0.65 BSC		
L	0.45	–	0.65

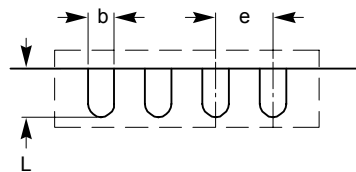

DETAIL A

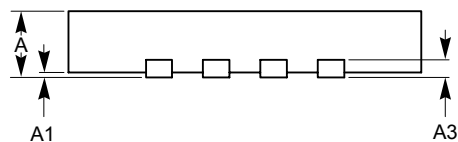

FRONT VIEW

For current Tape and Reel information, download the PDF file from:
<http://www.catsemi.com/documents/tapeandreel.pdf>.

Notes:

- (1) All dimensions are in millimeters.
- (2) Complies with JEDEC standard MO-220.

CAT3626

EXAMPLE OF ORDERING INFORMATION

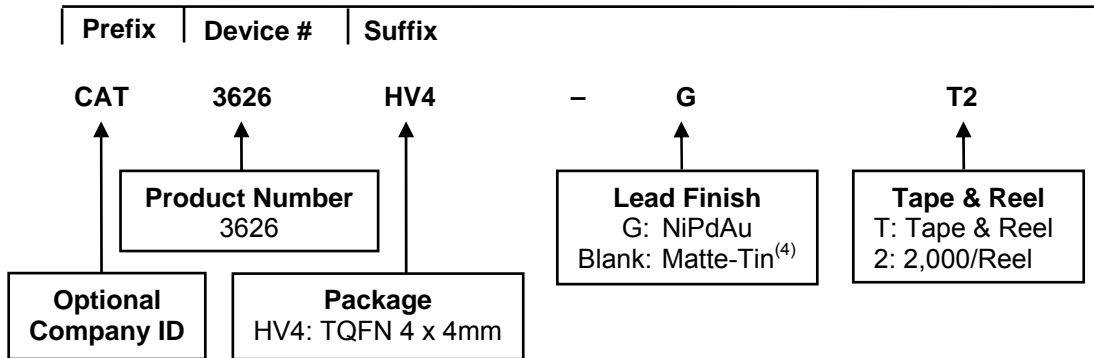

For Product Top Mark Codes, click here:
<http://www.catsemi.com/techsupport/producttopmark.asp>

Notes:

- (1) All packages are RoHS-compliant (Lead-free, Halogen-free).
- (2) The standard lead finish is NiPdAu.
- (3) The device used in the above example is a CAT3626HV4-GT2 (TQFN, NiPdAu Plated Finish, Tape & Reel, 2,000/Reel).
- (4) For Matte-Tin package option, please contact your nearest Catalyst Semiconductor Sales office.

REVISION HISTORY

Date	Rev.	Reason
20-Mar-06	A	Initial Issue
19-Nov-07	B	Added MD- to document number Update Ordering Information Update Package Outline Drawing Added Example of Ordering Information
07-Jan-08	C	Add Extended Temperature Range
30-May-08	D	Update Package Outline Drawing Add Top Mark Code Link

Copyrights, Trademarks and Patents

© Catalyst Semiconductor, Inc.

Trademarks and registered trademarks of Catalyst Semiconductor include each of the following:

Adaptive Analog™, Beyond Memory™, DPP™, EZDim™, LDD™, MiniPot™, Quad-Mode™ and Quantum Charge Programmable™

Catalyst Semiconductor has been issued U.S. and foreign patents and has patent applications pending that protect its products.

CATALYST SEMICONDUCTOR MAKES NO WARRANTY, REPRESENTATION OR GUARANTEE, EXPRESS OR IMPLIED, REGARDING THE SUITABILITY OF ITS PRODUCTS FOR ANY PARTICULAR PURPOSE, NOR THAT THE USE OF ITS PRODUCTS WILL NOT INFRINGE ITS INTELLECTUAL PROPERTY RIGHTS OR THE RIGHTS OF THIRD PARTIES WITH RESPECT TO ANY PARTICULAR USE OR APPLICATION AND SPECIFICALLY DISCLAIMS ANY AND ALL LIABILITY ARISING OUT OF ANY SUCH USE OR APPLICATION, INCLUDING BUT NOT LIMITED TO, CONSEQUENTIAL OR INCIDENTAL DAMAGES.

Catalyst Semiconductor products are not designed, intended, or authorized for use as components in systems intended for surgical implant into the body, or other applications intended to support or sustain life, or for any other application in which the failure of the Catalyst Semiconductor product could create a situation where personal injury or death may occur.

Catalyst Semiconductor reserves the right to make changes to or discontinue any product or service described herein without notice. Products with data sheets labeled "Advance Information" or "Preliminary" and other products described herein may not be in production or offered for sale.

Catalyst Semiconductor advises customers to obtain the current version of the relevant product information before placing orders. Circuit diagrams illustrate typical semiconductor applications and may not be complete.



Catalyst Semiconductor, Inc.
Corporate Headquarters
2975 Stender Way
Santa Clara, CA 95054
Phone: 408.542.1000
Fax: 408.542.1200
www.catsemi.com

Document No: MD-5014
Revision: D
Issue date: 05/30/08