

## FYL-25A9EGW1B

### Features:

- General purpose leads
- RoHs compliant.

### Descriptions:

- Dice material E: GaP  
G:GaP
- Emitting Color E: Red  
G: Yellow Green
- Device Outline:  $\Phi 3\text{mm}$  Round Type.
- Lens Type: White diffused.

### Radiation pattern.

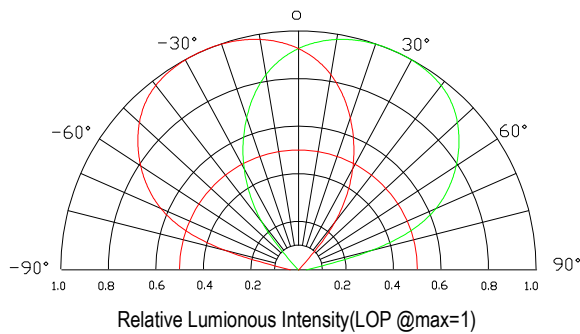

### Package configuration

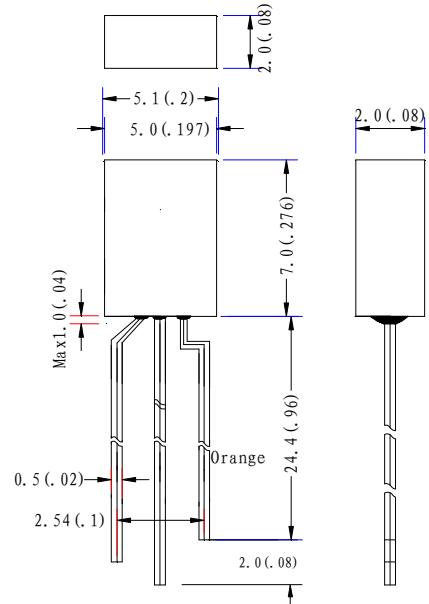

- ◆ All dimensions are millimeters (inches)
- ◆ Tolerance is  $\pm 0.25\text{mm}(.010\text{'})$  unless otherwise noted.

### Absolute maximum ratings( $T_a=25\text{ }^\circ\text{C}$ )

Parameter	MAX.		Unit
	Power Dissipation	E	
	G	50	
Peak Forward Current (1/10 Duty Cycle, 0.1ms Pulse Width)	100		mA
Continuous Forward Current	20		mA
Derating Linear From $50^\circ\text{C}$	0.4		mA/ $^\circ\text{C}$
Reverse Voltage	5		V
Operating Temperature Range	-30 $^\circ\text{C}$ to +80 $^\circ\text{C}$		
Storage Temperature Range	-40 $^\circ\text{C}$ to +100 $^\circ\text{C}$		
Lead Soldering Temperature[4mm(.157") From Body]	260 $^\circ\text{C}$ for 5 Seconds		

**Electrical and optical characteristics(Ta=25 °c)**

Parameter	Symbol	Min.	Typ.	Max.	Unit	Test Condition
Luminous Intensity	I <sub>v</sub>	E	-	45	-	mcd
		G	-	35	-	
Viewing Angle	2θ <sub>1/2</sub>	E	90	100	110	Deg
		G	90	100	110	
Peak Emission Wavelength	λ <sub>p</sub>	E	625	630	635	nm
		G	563	568	573	
Dominant Wavelength	λ <sub>d</sub>	E	620	625	630	nm
		G	567	572	577	
Spectral Line Half-Width	Δλ	E	10	15	20	nm
		G	15	20	25	
Forward Voltage	V <sub>F</sub>	E	1.8	2.0	2.4	V
		G	1.8	2.3	2.5	
Reverse Current	I <sub>R</sub>		-	50	uA	V <sub>R</sub> =5V

## Typical Electrical Characteristics Curves (25 °c Ambient Temperature Unless Otherwise Noted)

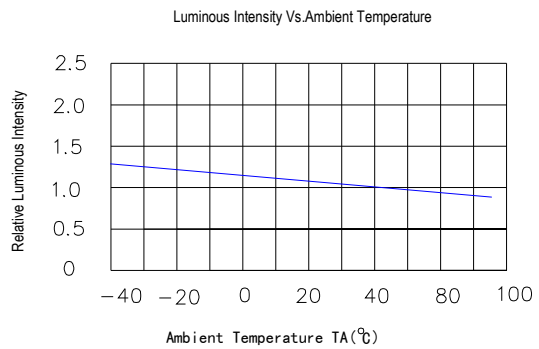
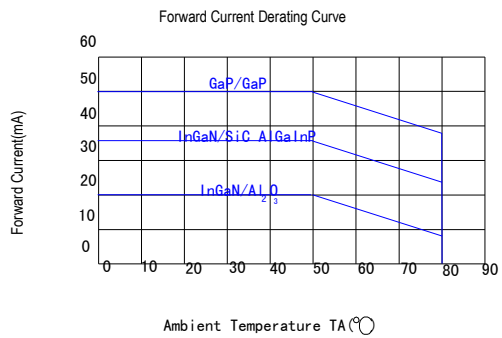
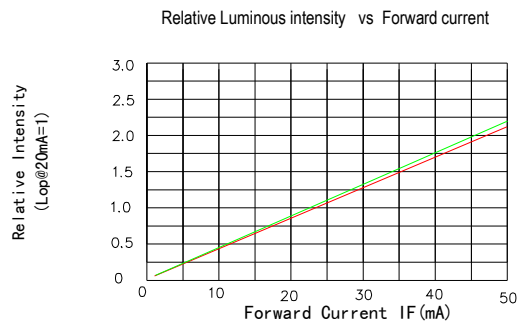
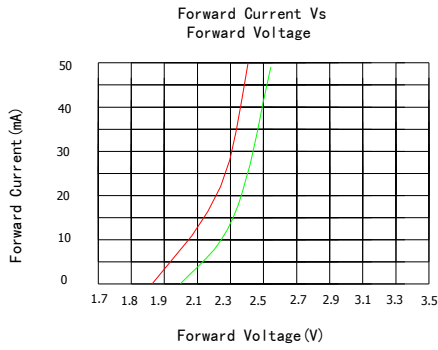
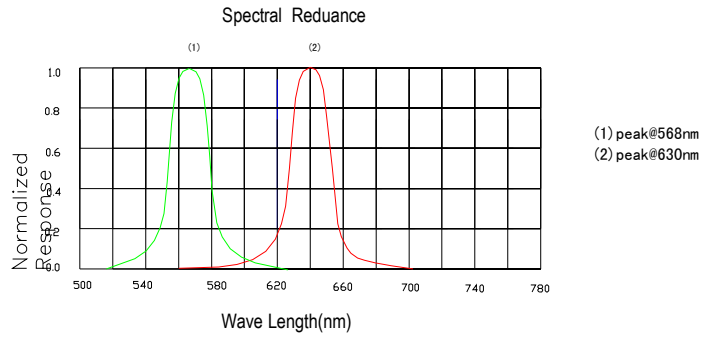

## LAMP PACKING.

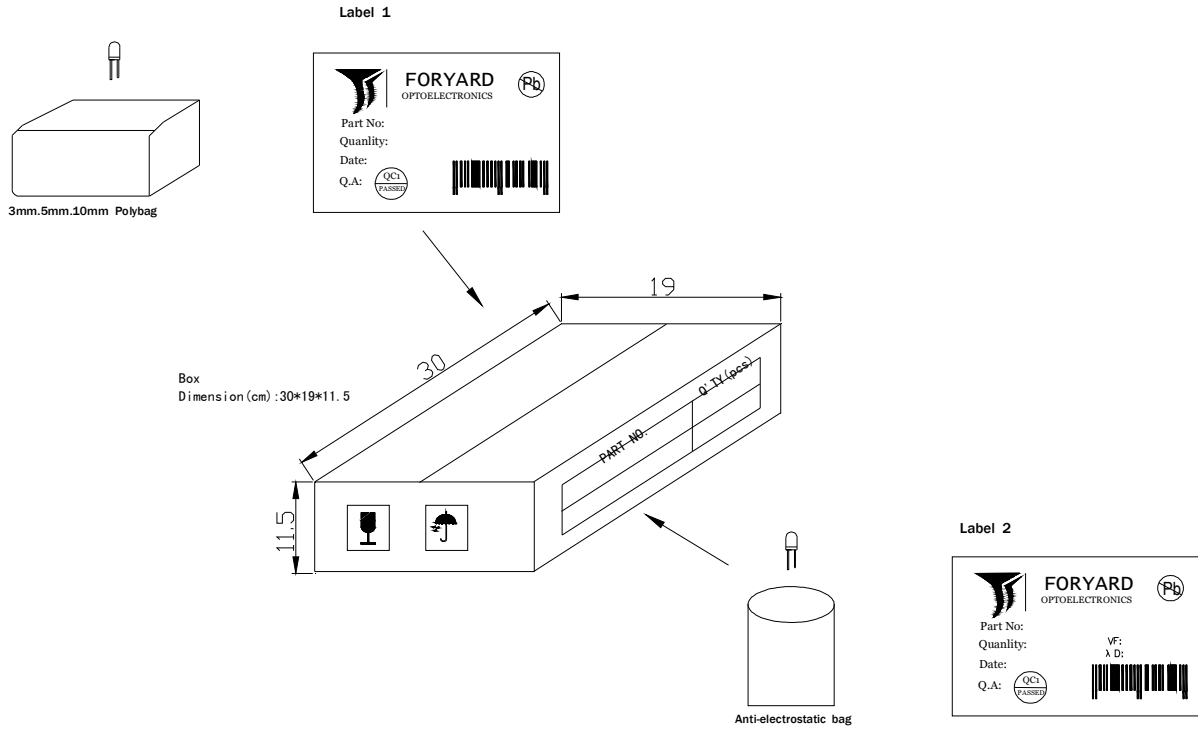

DEVICE	QTY/polybag(pcs)	Polybag/box A	Fig
5mm(T-1 3/4)	1000	8 bags	Label 1
3mm(T-1 )	1000	10 bags	Label 1
10mm(T-1)	250	8 bags	Label 1
Blue/Green/White	500pcs	8 bags	Label 2

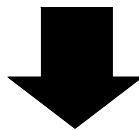

**CARTON**  
Dimension(cm):39\*32\*38

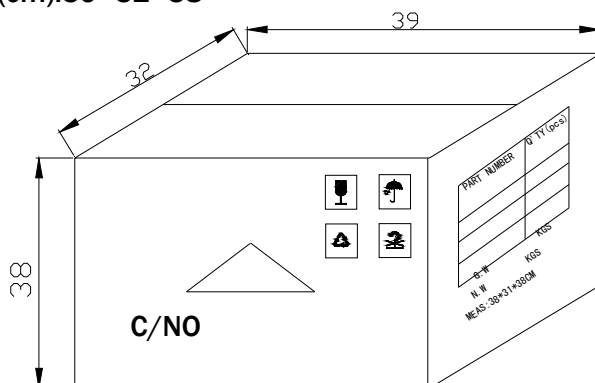

6 Boxes/Carton  
5mm:48,000pcs  
3mm:60,000pcs  
10mm:12,000pcs  
Blue/Pure Green/bluish Green  
/White:24,000pcs