

6-String 30mA LED Driver with 1.5% Current Matching

FEATURES

- True Color PWM™ Dimming Delivers Up to 3000:1 Dimming Ratio
- Drives Six Strings of LEDs at Up to 30mA
- 1.5% Accurate LED Current Matching
- Wide Input Voltage Range: 3.2V to 30V
- Output Voltage Up to 44V
- Regulates Current Even When $V_{IN} > V_{OUT}$
- Disconnects LEDs in Shutdown
- Programmable Open LED Protection (Regulated)
- OPENLED Alert Pin
- Programmable LED Current Derating
- Adjustable Frequency: 200kHz to 2.5MHz
- Synchronizable to an External Clock
- Parallel Channels for Higher Current per LED String
- Thermally Enhanced 4mm × 4mm QFN Package

APPLICATIONS

- Notebook Computer Display
- Medium Size Displays
- Automotive LCD Display

DESCRIPTION

The LT[®]3598 is a fixed frequency step-up DC/DC converter designed to drive up to six strings of LEDs at an output voltage up to 44V. LED dimming can be achieved with analog dimming on the CTRL pin, and with pulse width modulation dimming on the PWM pin. The LT3598 accurately regulates LED current even when the input voltage is higher than the LED output voltage. The switching frequency is programmable from 200kHz to 2.5MHz through an external resistor.

Additional features include programmable overvoltage protection, switching frequency synchronization to an external clock, LED current derating based on junction temperature and/or LED temperature, LED string disable control, OPENLED alert pin and output voltage limiting when all LED strings are disconnected. The LT3598 is available in a thermally enhanced 24-pin (4mm × 4mm) QFN package.

LT, LTC and LTM are registered trademarks of Linear Technology Corporation. True Color PWM is a trademark of Linear Technology Corporation. All other trademarks are the property of their respective owners. Protected by U.S. Patents, including 7199560, 7321203.

TYPICAL APPLICATION

90% Efficient LED Driver for 60 White LEDs

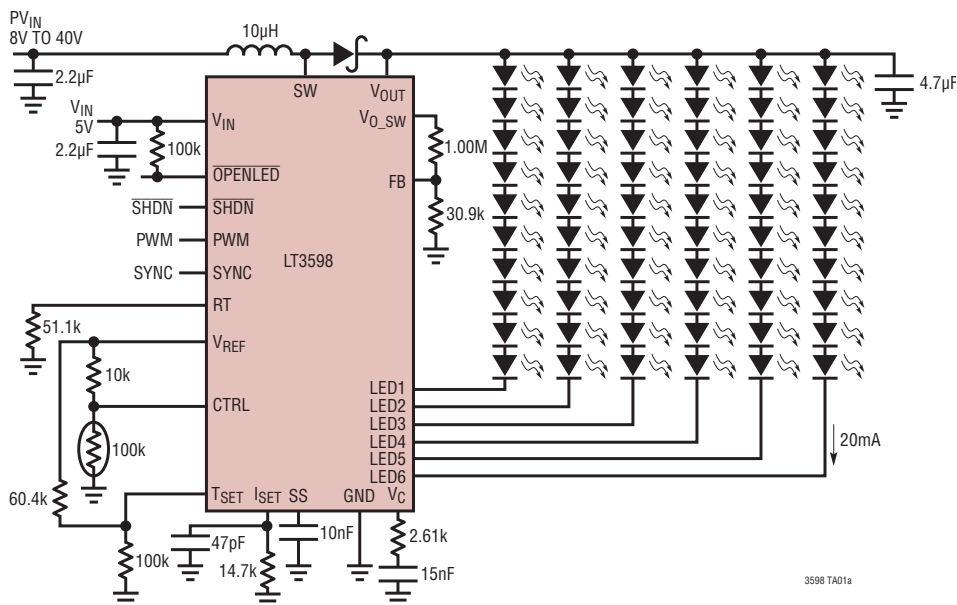

LED Current Matching

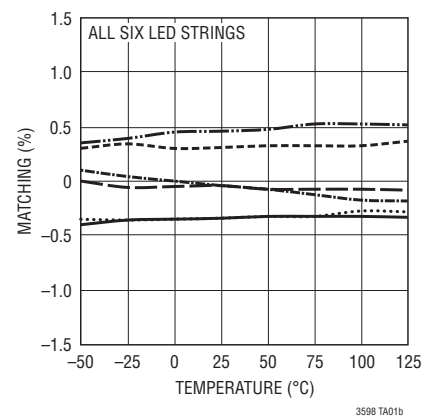

LT3598

ABSOLUTE MAXIMUM RATINGS

(Note 1)

SHDN	$V_{IN} + 3V$
V_{IN} , OPENLED	30V
SW Voltage	45V
V_{OUT} , V_{O_SW} Voltage	44V
LED1 to LED6	44V
PWM, SYNC, CTRL, RT, SS, V_C	6V
V_{REF} , FB Voltage	6V
I_{SET} , T_{SET}	6V
Operating Junction Temperature Range (Note 2)	-40°C to 125°C
Maximum Junction Temperature	125°C
Storage Temperature Range	-65°C to 150°C

PIN CONFIGURATION

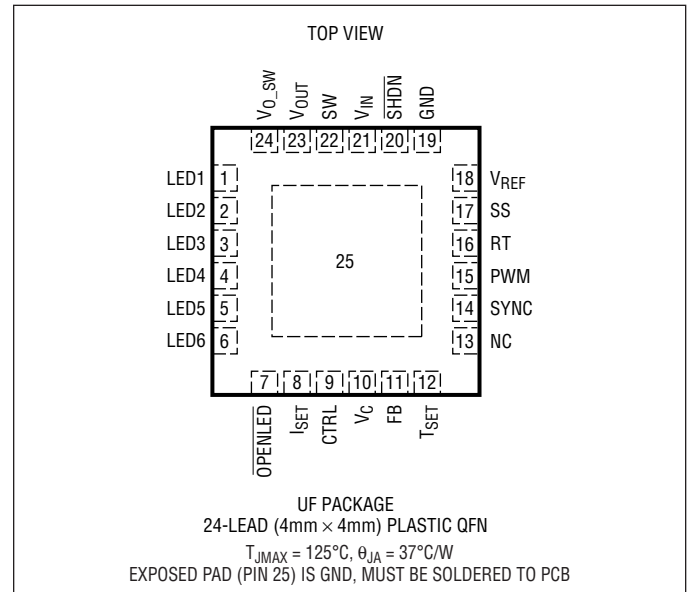

ORDER INFORMATION

LEAD FREE FINISH	TAPE AND REEL	PART MARKING*	PACKAGE DESCRIPTION	TEMPERATURE RANGE
LT3598EUF#PBF	LT3598EUF#TRPBF	3598	24-Lead (4mm × 4mm) Plastic QFN	-40°C to 125°C
LT3598IUF#PBF	LT3598IUF#TRPBF	3598	24-Lead (4mm × 4mm) Plastic QFN	-40°C to 125°C

Consult LTC Marketing for parts specified with wider operating temperature ranges. *The temperature grade is identified by a label on the shipping container. Consult LTC Marketing for information on non-standard lead based finish parts.

For more information on lead free part marking, go to: <http://www.linear.com/leadfree/>

For more information on tape and reel specifications, go to: <http://www.linear.com/tapeandreel/>

ELECTRICAL CHARACTERISTICS

The ● denotes the specifications which apply over the full operating temperature range, otherwise specifications are at $T_A = 25^{\circ}C$. $V_{IN} = 5V$, $V_{SHDN} = V_{IN}$ unless otherwise noted. (Note 2)

PARAMETER	CONDITIONS	MIN	TYP	MAX	UNITS
Minimum Operating Voltage			3	3.2	V
Maximum Operating Voltage				30	V
Reference Voltage		1.216 ● 1.210	1.230	1.260 1.260	V V
Reference Voltage Line Regulation	$3 < V_{IN} < 30V$, $V_C = 0.3V$		0.01	0.03	%/V
Maximum V_{REF} Pin Current	Out of Pin	200			μA
FB Pin Bias Current	$V_{FB} = 1.230V$ (Note 3)		100	250	nA
FB Error Amp Transconductance	$\Delta I = 5\mu A$		300		$\mu mhos$
FB Error Amp Voltage Gain			600		V/V
FB Pin Voltage		1.22	1.24	1.26	V
Current Loop Amp Transconductance			21		$\mu mhos$

3598f

ELECTRICAL CHARACTERISTICS The ● denotes the specifications which apply over the full operating temperature range, otherwise specifications are at $T_A = 25^\circ\text{C}$. $V_{IN} = 5\text{V}$, $V_{SHDN} = V_{IN}$ unless otherwise noted. (Note 2)

PARAMETER	CONDITIONS	MIN	TYP	MAX	UNITS	
Current Loop Amp Voltage Gain			80		V/V	
V_C Sink Current			10		μA	
Quiescent Current	$V_{SHDN} = 5\text{V}$, PWM = 0V, Not Switching		3.5	5	mA	
Quiescent Current in Shutdown	$V_{SHDN} = 0\text{V}$		0	1	μA	
I_{SET} Voltage	$V_{CTRL} = 1.5\text{V}$, $V_{TSET} = 1.5\text{V}$, $R_{ISET} = 14.7\text{k}\Omega$	0.985	1.000	1.015	V	
LED Current	$R_{ISET} = 14.7\text{k}\Omega$	19.5	20	20.7	mA	
LED String Current Matching	20mA LED Current	●	± 0.5	± 1.5	%	
LED Open Detection Threshold			0.2	0.25	V	
OPENLED Sink Current			2		mA	
Minimum LED Regulation Voltage			0.8		V	
LED1-6 Leakage Current	$V_{LED1-6} = 1\text{V}$, $V_{OUT} = 5\text{V}$, PWM = 0V $V_{LED1-6} = 42\text{V}$, $V_{OUT} = 44\text{V}$, PWM = 0V		0.1 0.2	1 2	μA μA	
CTRL Pin Bias Current	$V_{CTRL} = 0.8\text{V}$ (Note 4)		50	125	nA	
Switching Frequency	$R_T = 309\text{k}\Omega$ $R_T = 51.1\text{k}\Omega$ $R_T = 14.7\text{k}\Omega$	171 0.9 2.25	190 1 2.5	209 1.1 2.75	kHz MHz MHz	
T_{SET} Voltage			602		mV	
Maximum Switch Duty Cycle	$R_T = 309\text{k}\Omega$ $R_T = 51.1\text{k}\Omega$ $R_T = 14.7\text{k}\Omega$	●	90 87 80	95 90 86	% % %	
Switch Current Limit	(Note 5)		1.5	2	2.5	A
Switch V_{CESAT}	$I_{SW} = 0.5\text{A}$		0.12		V	
Switch Leakage Current	$V_{SW} = 40\text{V}$		0.2	5	μA	
SHDN Pin Current	$V_{SHDN} = 0\text{V}$, $V_{IN} = 0\text{V}$ $V_{SHDN} = 5\text{V}$, $V_{IN} = 5\text{V}$		0.1 30	1 60	μA μA	
SHDN Voltage High			1.6		V	
SHDN Voltage Low				0.4	V	
Soft-Start Charging Current	$V_{SS} = 0.1\text{V}$		5	10	15	μA
PWM Input High Voltage			1		V	
PWM Input Low Voltage				0.4	V	
PWM Pin Bias Current	PWM = 3.3V		0.1	1	μA	
SYNC Input High Voltage			1.5		V	
SYNC Input Low Voltage				0.4	V	
SYNC Pin Bias Current	SYNC = 0V SYNC = 3.3V		25 0.1	50 1	μA μA	
V_{O_SW} Switch Resistance				1000	Ω	

Note 1: Stresses beyond those listed under Absolute Maximum Ratings may cause permanent damage to the device. Exposure to any Absolute Maximum Rating condition for extended periods may affect device reliability and lifetime.

Note 2: The LT3598E is guaranteed to meet performance specifications from 0°C to 125°C junction temperature. Specifications over the -40°C to 125°C operating junction temperature range are assured by design,

characterization and correlation with statistical process controls. The LT3598I is guaranteed over the full -40°C to 125°C operating junction temperature range.

Note 3: Current flows out of FB pin.

Note 4: Current flows out of CTRL pin.

Note 5: Current limit guaranteed by design and/or correlation to static test. Current limit is independent of duty cycle and is guaranteed by design.

TYPICAL PERFORMANCE CHARACTERISTICS

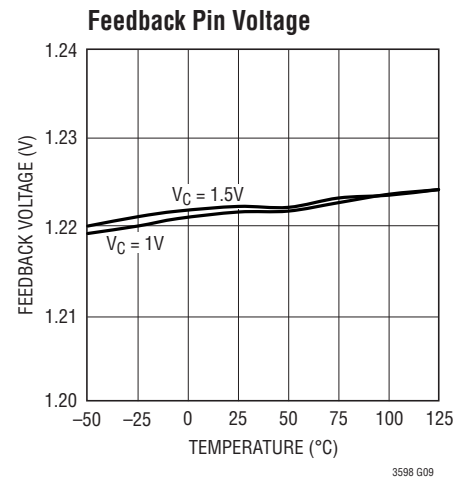
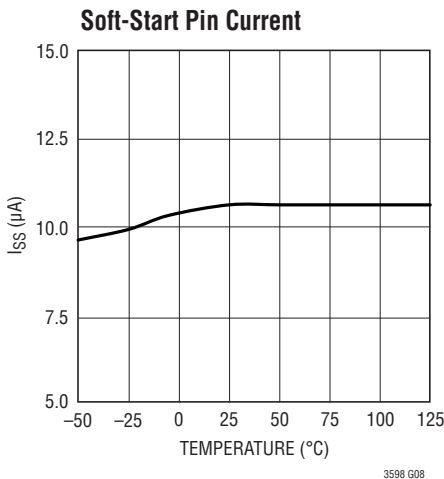
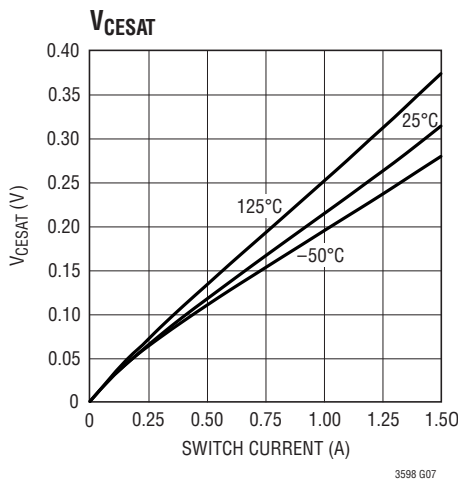
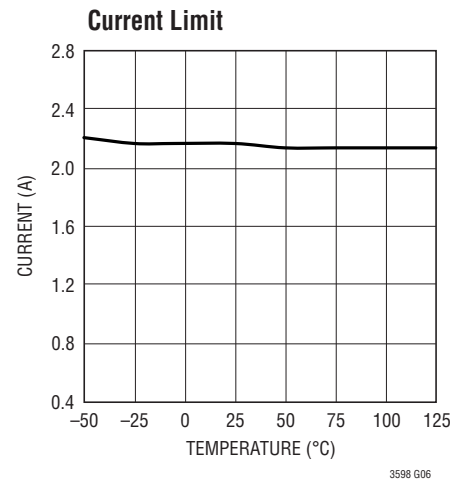
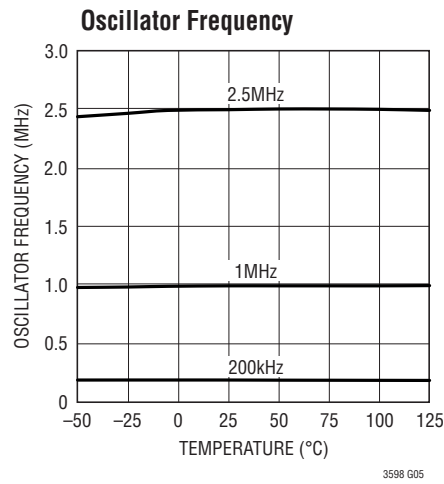
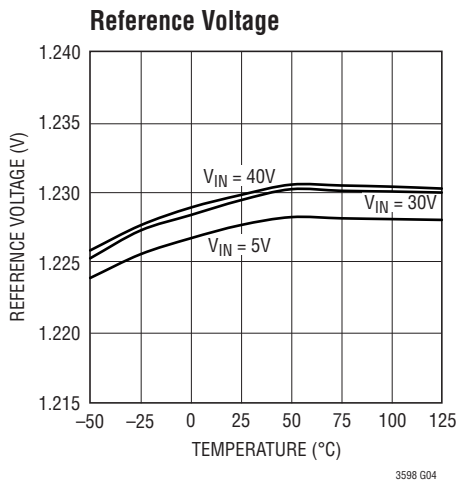
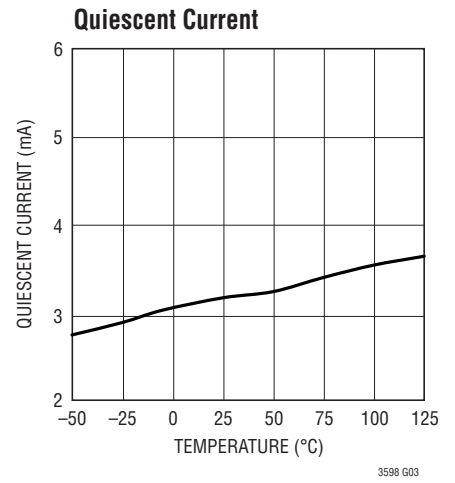
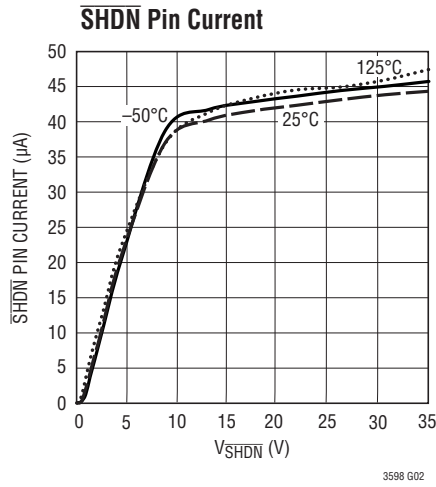
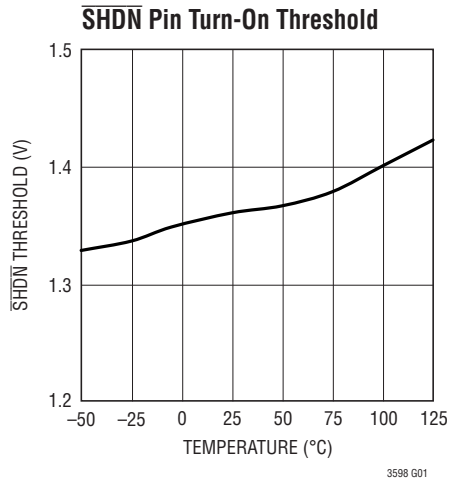

TYPICAL PERFORMANCE CHARACTERISTICS

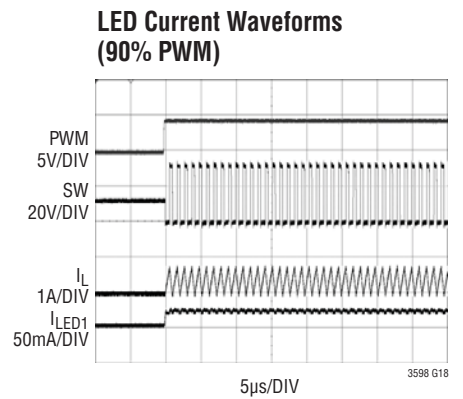
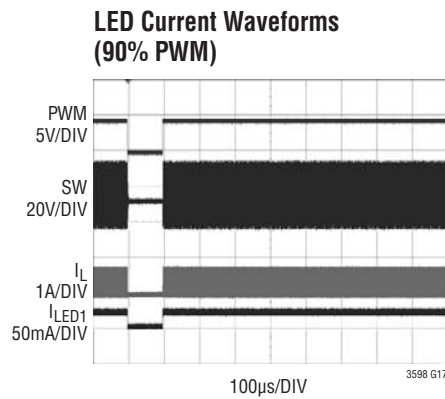
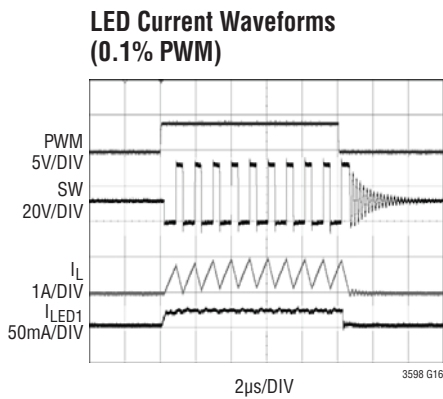
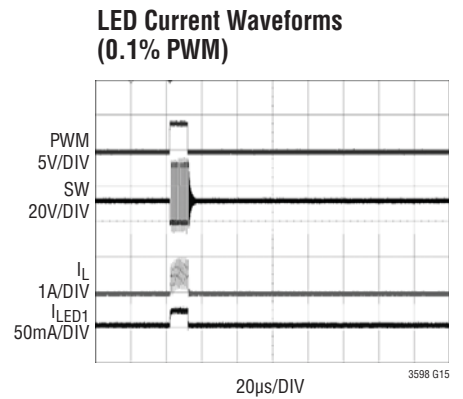
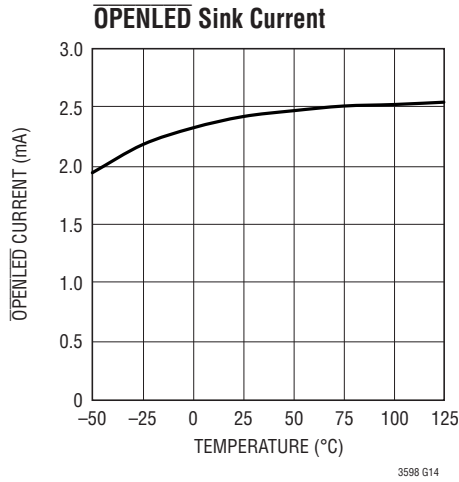
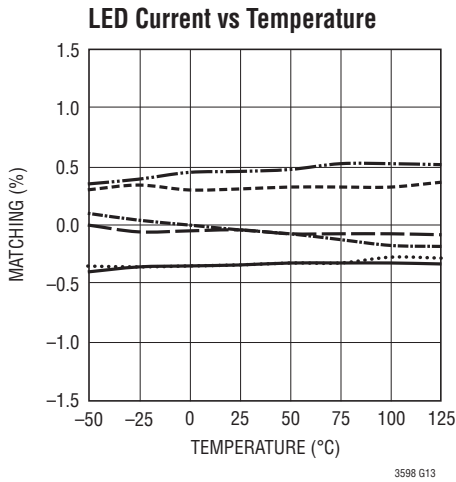
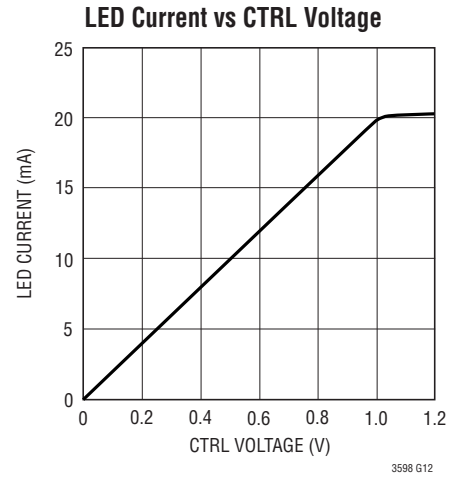
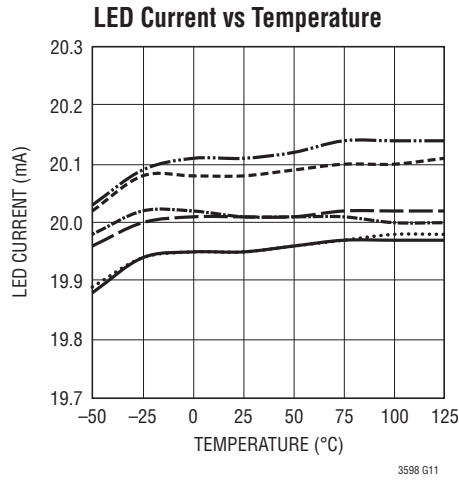
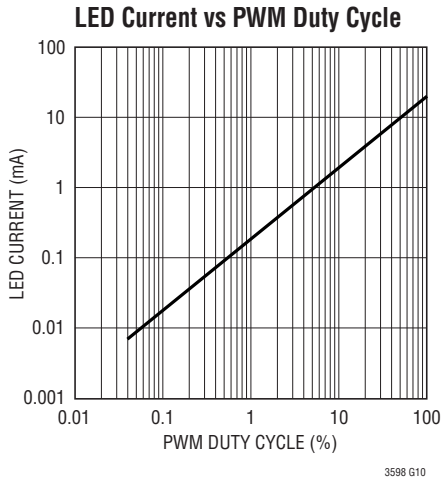

PIN FUNCTIONS

LED1-6 (Pins 1, 2, 3, 4, 5, 6): LED String Output. Connect the bottom cathode of each LED string to these pins. Tie pins to V_{OUT} if the string is not used.

OPENLED (Pin 7): Open LED Flag When Any LED String Opens. The output is open-collector. Tie a resistor to other supply for open LED flag function.

I_{SET} (Pin 8): Programs LED Current for Each String. Connect a 14.7k resistor between I_{SET} and GND to program each LED string current to 20mA. A 47pF capacitor on the I_{SET} pin reduces current ripple in each LED string.

CTRL (Pin 9): LED Current Control. If the CTRL pin is not used, tie this pin to V_{REF} through a 10k to 20k resistor.

V_C (Pin 10): Error Amplifier Output Pin. Tie the external compensation network to this pin.

FB (Pin 11): Feedback Pin for Overvoltage Protection. Reference voltage is 1.230V. Connect the resistive divider tap here. Minimize trace area at FB. Set V_{OUT} according to $V_{OUT} = 1.230(1 + R_2/R_1)$ when overvoltage protection occurs (see Figure 2).

T_{SET} (Pin 12): An external resistor divider from V_{REF} programs a decrease in LED current versus internal junction temperature (setting temperature breakpoint and slope). If the T_{SET} pin is not used, tie this pin to V_{REF} .

NC (Pin 13): No Connection.

SYNC (Pin 14): Frequency Synchronization Pin. This input allows for synchronizing the operating frequency to an external clock. The RT resistor should be chosen to program a switching frequency 20% slower than SYNC pulse frequency. This pin should be grounded if this feature is not used.

PWM (Pin 15): Input Pin for PWM Dimming Control. Above 1V allows converter switching and below 1V disables switching with V_C pin level maintained. A PWM signal

driving the PWM pin provides accurate dimming control. The PWM signal can be driven from 0V to 5V. If unused, the pin should be connected to V_{REF} .

RT (Pin 16): A resistor to ground programs switching frequency between 200kHz and 2.5MHz. For SYNC function, choose the resistor to program a frequency 20% slower than the SYNC pulse frequency. Do not leave this pin open.

SS (Pin 17): Soft-Start Pin. Place a soft-start capacitor here. Upon start-up, a 10 μ A current charges the capacitor. Use a larger capacitor for slower start-up. Leave open if not used.

V_{REF} (Pin 18): Bandgap Voltage Reference. Internally set to 1.230V. This pin can supply up to 100 μ A. Can be used to program the CTRL pin voltage using resistor dividers to ground.

GND (Pin 19): Ground. Tie directly to local ground plane.

SHDN (Pin 20): Shutdown Pin. Tie to 1.6V or more to enable the device. Tie below 0.4V or less to disable device. Do not float this pin.

V_{IN} (Pin 21): Input Supply Pin. Must be locally bypassed with a capacitor to ground.

SW (Pin 22): Switch Pin. This is the collector of the internal NPN power switch. Minimize the metal trace area connected to this pin to minimize EMI.

V_{OUT} (Pin 23): Output Pin. This pin provides power to all LEDs.

V_{O_SW} (Pin 24): Drain of an Internal PMOS. The internal PMOS disconnects the feedback resistors from the V_{OUT} pin during shutdown and the PWM transitioned to low.

Exposed Pad (Pin 25): Ground. The Exposed Pad must be soldered to the PCB.

BLOCK DIAGRAM

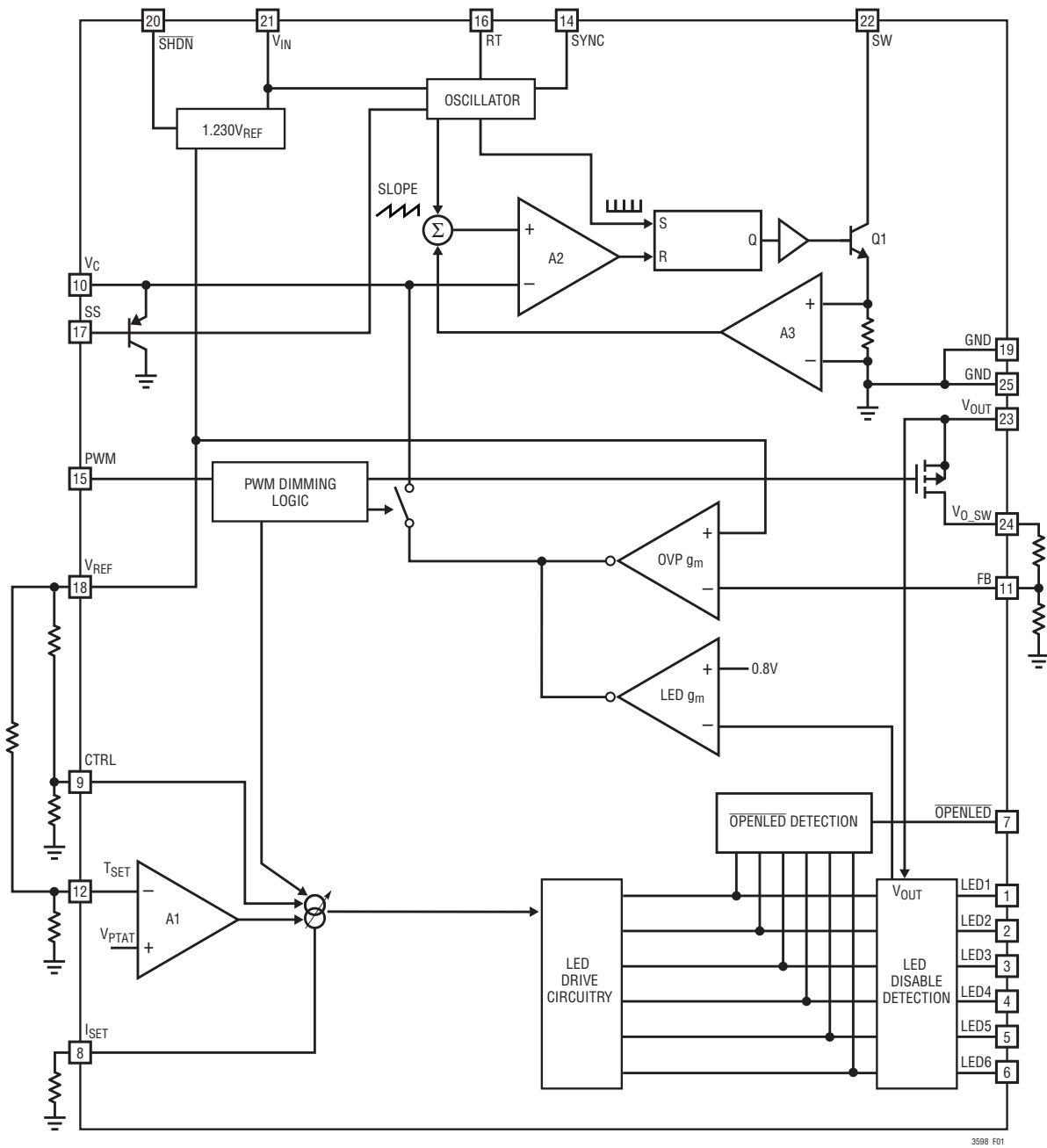

Figure 1. Block Diagram

OPERATION

The LT3598 uses a constant-frequency, peak current mode control scheme to provide excellent line and load regulation. Each string can drive up to 30mA with 1.5% matching accuracy between strings. Operation can be best understood by referring to the Block Diagram in Figure 1.

LT3598 has a built-in boost converter which converts the input voltage to a higher output voltage to drive LEDs. The LED strings are connected to current sources where the current level is set with an external resistor on the I_{SET} pin. The LED1 to LED6 voltages are monitored for output voltage regulation. During normal operation, when all LEDs are used, the lowest LED pin voltage (LED1 to LED6) is used to regulate the output voltage to ensure all LED strings have enough voltage to run the programmed current.

For any unused LED strings, tie their LED pins to V_{OUT} . An unused LED string is no longer in the regulation loop, nor does it affect open LED detection. Never allow unused LED strings to be left open.

The basic loop uses a pulse from an internal oscillator to set the SR latch and turn on the internal power NPN switch Q1. The signal at the noninverting input of the PWM comparator (A2 slope) is proportional to the sum of the switch current and oscillator ramp. When slope exceeds V_C (the output of the g_m amplifier), the PWM comparator resets the latch. The switch is then turned off, causing the inductor current to lift the SW pin and turn on an external Schottky diode connected to the output. Inductor current flows via the Schottky diode charging the output capacitor. The switch is turned on again at the next reset cycle of the internal oscillator. During normal operation, the V_C voltage controls the peak switch current limit and, hence, the inductor current available to the output LEDs.

Dimming of the LEDs is accomplished by pulsing the LED current using the PWM pin. When the PWM pin is low, switching is disabled and the error amplifier is turned off so that it does not drive the V_C pin. Also, all internal loads on the V_C pin are disabled so that the state of the V_C pin

is maintained on the external compensation capacitor. This feature reduces transient recovery time. When the PWM input again transitions high, the peak switch current returns to the correct value.

The LT3598 uses the FB pin to provide overvoltage protection when all LED strings are open. There is an internal PMOS switch between V_{OUT} and V_{O_SW} that is controlled by the PWM signal. During the PWM off-period, this PMOS is turned off, allowing for higher dimming range and lower current during shutdown. A resistor divider is connected between the V_{O_SW} pin and ground, which sets the overvoltage protection voltage.

If the LED1-6 pin voltage is below 0.2V (for a certain delay after 80% of the programmed output voltage is reached), the string is treated as an open LED string. As a result, $\overline{OPENLED}$ lag is set. If a LED string is open in the middle of the operation, the regulation will continue.

$\overline{OPENLED}$ detection is disabled during the start-up phase to avoid erratic flag generation. An LED string that is disabled by connecting its LED pin to V_{OUT} is not an open LED condition. During normal operation, if an LED string is open and has the lowest LED pin voltage, the output voltage will regulate itself to find another LED string that has the lowest LED pin voltage at about 0.8V. If the open LED string has an LED voltage above 0.8V, the output voltage will remain the same. When the LED string is open, it is no longer in the regulation loop. The $\overline{OPENLED}$ detection is active only when the PWM signal is enabled. To avoid spurious $\overline{OPENLED}$ detection and high PWM dimming ratio, more output capacitance is recommended to allow less voltage drop on V_{OUT} .

During start-up, 10 μ A of current charges the external soft-start capacitor. The SS pin directly limits the rate of voltage rise on the V_C pin, which in turn, limits the peak switch current. Soft-start also enables the switching frequency foldback to provide a clean start-up for the LT3598. Current limit protects the power switch and external components.

APPLICATIONS INFORMATION

Inductor Selection

Table 1 lists several inductors that work well with the LT3598, however, there are many other manufacturers and devices that can be used. Consult each manufacturer for detailed information on their entire range of parts. Ferrite core inductors should be used to obtain the best efficiency. Choose an inductor that can handle the necessary peak current without saturating. Also, ensure that the inductor has a low DCR (copper wire resistance) to minimize I^2R power losses. Values between 4.7 μ H and 22 μ H will suffice for most applications.

Inductor manufacturers specify the maximum current rating as the current where inductance falls by a given percentage of its nominal value. An inductor can pass a current greater than its rated value without damaging it. Consult each manufacturer to determine how the maximum inductor current is measured and how much more current the inductor can reliably conduct.

Table 1. Recommended Inductors

PART	L (μ H)	MAX DCR (Ω)	CURRENT RATING (A)	VENDOR
B1015AS-100M	10	0.07	2.2	TOKO www.toko.com
#817FY-4R7M	4.7	0.06	2.26	
1123AS-4R7M	4.7	0.12	1.90	
74454068	6.8	0.055	2.2	Würth Electronics www.we-online.com
74454010	10	0.065	2	
7447745100	10	0.12	1.7	
CDH74NP-120L	12	0.065	2.45	Sumida www.sumida.com
CDH74NP-150L	15	0.083	2.10	
CDRH6D38-100	10	0.038	2.00	
IHLP-2525BD-01	10	0.129	2.5	Vishay www.vishay.com
SD25-4R7-R	4.7	0.056	1.83	Cooper www.cooperet.com
LPS4018-472ML	4.7	0.200	1.8	Coilcraft www.coilcraft.com

Capacitor Selection

Low ESR (equivalent series resistance) ceramic capacitors should be used at the output to minimize the output ripple voltage. Use only X5R or X7R dielectrics, as these materials retain their capacitance over wider voltage and

temperature ranges than other dielectrics. A 4.7 μ F to 10 μ F output capacitor is sufficient for most high output current designs. Table 2 lists some suggested manufacturers. Consult the manufacturers for detailed information on their entire selection of ceramic parts.

Table 2. Recommended Ceramic Capacitor Manufacturers

Taiyo Yuden	408-573-4150 www.t-yuden.com
AVX	843-448-9411 www.avxcorp.com
Murata	770-436-1300 www.murata.com
Kemet	408-986-0424 www.kemet.com
United Chemi-Con	847-696-2000 www.chemi-con.com

Diode Selection

Schottky diodes, with their low forward voltage drop and fast switching speed, must be used for all LT3598 applications. Do not use P-N diodes. Table 3 lists several Schottky diodes that work well. The diode's average current rating must exceed the application's average output current. The diode's maximum reverse voltage must exceed the application's output voltage. A 2A diode is sufficient for most designs. For PWM dimming applications, be aware of the reverse leakage current of the diode. Lower leakage current will drain the output capacitor less, allowing for higher dimming range. The companies below offer Schottky diodes with high voltage and current ratings.

Table 3. Suggested Diodes

PART	MAX CURRENT (A)	MAX REVERSE VOLTAGE (V)	MANUFACTURER
B250A	2	50	Diodes, Inc. www.diodes.com
B240A	2	40	
SBR140S3	1	40	
SBM340, PDS340	3	40	
HSM150G	1	50	Microsemi www.microsemi.com
HSM150J	1	50	
SS3H9	3	90	Vishay www.vishay.com

APPLICATIONS INFORMATION

Overvoltage Protection

The LT3598 uses the FB pin to provide regulated overvoltage protection when all LED strings are open. A resistor divider is connected between the V_{O_SW} pin and ground (Figure 2). There is an internal PMOS switch between V_{OUT} and V_{O_SW} , which is controlled by the PWM signal. The PMOS switch addition prevents the feedback resistor divider from draining the output capacitor during PWM off-period, allowing for a higher dimming range without falsely tripping the $\overline{OPENLED}$ flag. It also reduces the system current in shutdown. This PMOS has about 1k resistance, so select FB resistors taking this resistance into account.

To set the maximum output voltage, select the values of R1 and R2 (see Figure 2) according to the following equation:

$$V_{OUT(MAX)} = 1.230V \left(1 + \frac{R2}{R1} \right)$$

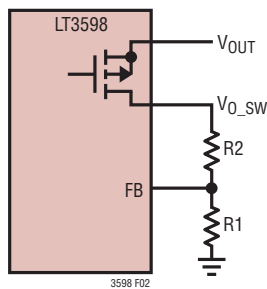

Figure 2. Overvoltage Protection Voltage Feedback Connections

The output voltage should be set higher than the normal LED string operating voltage. Under normal operation, LED1 to LED6 pin voltages are monitored and provide feedback information to the converter for output voltage regulation given the programmed LED current. The maximum output regulation loop is activated only when all LEDs are open.

Programming Maximum LED Current

Maximum LED current is programmed by placing a resistor between the I_{SET} pin and ground (R_{ISET}). The I_{SET} pin resistor can be selected from 10k to 100k.

The LED current is programmed according to the following equation:

$$I_{LED} \approx \frac{294V}{R_{ISET}}$$

See Table 4 and Figure 3 for resistor values and corresponding programmed LED current.

LED current can also be adjusted by programming the CTRL pin voltage.

Table 4. R_{ISET} Value Selection for LED Current

LED CURRENT (mA)	RESISTOR ON I_{SET} PIN (k)
3mA	97.6
10mA	29.4
20mA	14.7
30mA	9.76

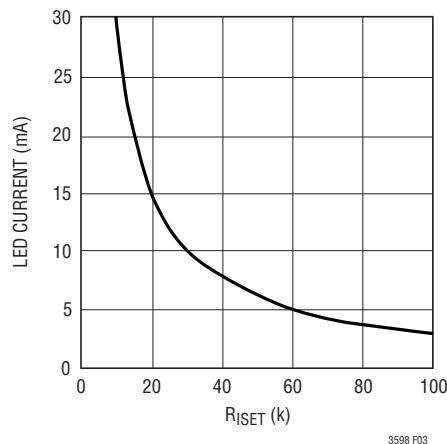

Figure 3. R_{ISET} Value Selection for LED Current

APPLICATIONS INFORMATION

LED Current Dimming

Two different types of dimming control can be used with the LT3598. The LED current can be set by modulating the CTRL pin or the PWM pin.

For some applications, a variable DC voltage that adjusts the LED current is the preferred method of brightness control. The CTRL pin voltage can be modulated to set the dimming of the LED string (see Figures 4 and 5). As the voltage on the CTRL pin increases from 0V to 1.0V, the LED current increases from 0 to the programmed LED current level. As the CTRL pin voltage increases beyond 1V, it has no effect on the LED current.

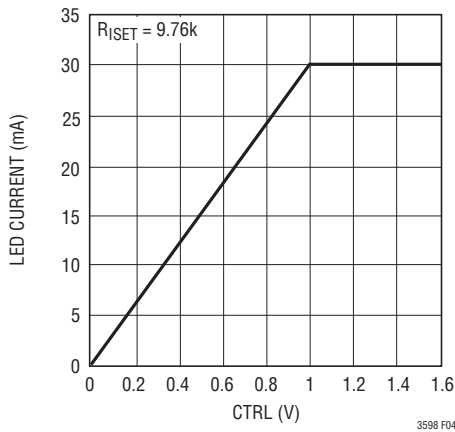

Figure 4. LED Current vs CTRL Voltage

For True Color PWM™ dimming, the LT3598 provides up to a 3000:1 PWM dimming range. This is achieved by allowing the duty cycle of the PWM pin (connected to the IC and an internal switch in series with the LED(s)), to be reduced from 100% to as low as 0.1% for a PWM frequency of 100Hz (Figure 6). PWM duty cycle dimming allows for constant LED color to be maintained over the entire dimming range.

For wide PWM dimming range, higher switching frequency and lower PWM frequency configuration are needed. Special considerations are required for component selection and compensation network. Please contact factory for optimized components selection if very high dimming ratio is desired.

True Color PWM is a registered trademark of Linear Technology Corporation.

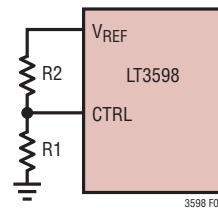

Figure 5. LED Current vs CTRL

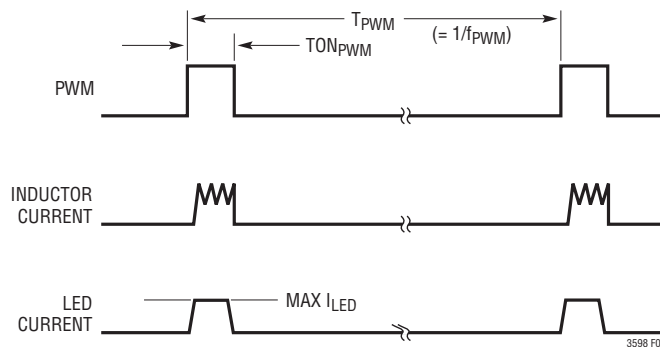

Figure 6. LED Current Using PWM Dimming

APPLICATIONS INFORMATION

LED Current Derating Using the CTRL Pin

A useful feature of the LT3598 is its ability to program a derating curve for maximum LED current versus temperature. LED data sheets provide curves of maximum-allowable LED current versus temperature to warn against exceeding this current limit and damaging the LED. The LT3598 allows the output LEDs to be programmed for maximum allowable current while still protecting the LEDs from excessive currents at high temperature. This is achieved by programming a voltage at the CTRL pin with a negative temperature coefficient using a resistor divider with temperature dependent resistance (Figure 7). As ambient temperature increases, the CTRL voltage will fall below the internal 1V voltage reference, causing LED currents to be controlled by the CTRL pin voltage. The LED current curve breakpoint and slope versus temperature is defined by the choice of resistor ratios and use of temperature-dependent resistance in the divider for the CTRL pin.

Table 5 shows a list of manufacturers/distributors of NTC resistors. There are several other manufacturers available and the chosen supplier should be contacted for more detailed information. If an NTC resistor is used to indicate LED temperature, it is effective only if the resistor is connected as closely as possible to the LED strings. LED derating curves shown by manufacturers are listed for ambient temperature. The NTC resistor should have the same ambient temperature as the LEDs. Since the temperature dependency of an NTC resistor can be non-linear over a wide range of temperatures, it is important to obtain a resistor's exact value over temperature from

the manufacturer. Hand calculations of CTRL voltage can then be performed at each given temperature, resulting in the CTRL versus temperature plotted curve. Several iterations of resistor value calculations may be required to achieve the desired breakpoint and slope of the LED current derating curve.

Table 5. NTC Resistor Manufacturers/Distributors

Murata Electronics North America	770-436-1300 www.murata.com
TDK Corporation	516-535-2600 www.tdk.com
Digi-Key	800-344-4539 www.digikey.com

If calculating the CTRL voltage at various temperatures gives a downward slope that is too strong, alternative resistor networks can be chosen (B, C, D in Figure 7) which use temperature independent resistance to reduce the effects of the NTC resistor overtemperature.

Murata Electronics provides a selection of NTC resistors with complete data over a wide range of temperatures. In addition, a software tool is available which allows the user to select from different resistor networks and NTC resistor values, and then simulate the exact output voltage curve (CTRL behavior) overtemperature. Referred to as the "Murata Chip NTC Thermistor Output Voltage Simulator," users can log onto www.murata.com and download the software followed by instructions for creating an output voltage V_{OUT} (CTRL) from a specified V_{CC} supply (V_{REF}).

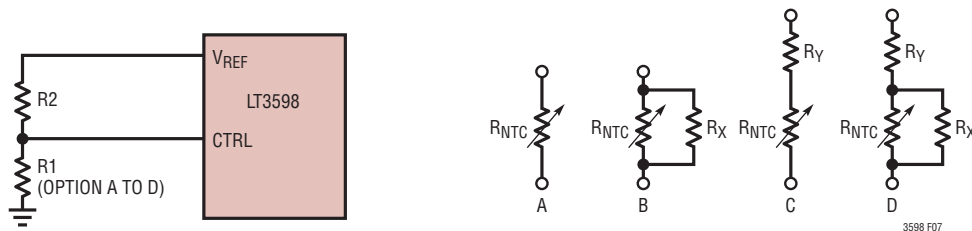

Figure 7 . LED Current Derating vs Temperature Using NTC Resistor

APPLICATIONS INFORMATION

Using the T_{SET} Pin for Thermal Protection

The LT3598 contains a special programmable thermal regulation loop that limits the internal junction temperature of the part. Since the LT3598 topology consists of a single boost converter with six linear current sources, any LED string voltage mismatch will cause additional power to be dissipated in the package. This topology provides excellent current matching between LED strings and allows a single power stage to drive a large number of LEDs, but at the price of additional power dissipation inside the part (which means a higher junction temperature). Being able to limit the maximum junction temperature allows the benefits of this topology to be fully realized. This thermal regulation feature provides important protection at high ambient temperatures, and allows a given application to be optimized for typical, not worst-case, ambient temperatures with the assurance that the LT3598 will automatically protect itself and the LED strings under worst-case conditions.

The operation of the thermal loop is simple. As the ambient temperature increases, so does the internal junction temperature of the part. Once the programmed maximum junction temperature is reached, the LT3598 begins to linearly reduce the LED current, as needed, to try and maintain this temperature. This can only be achieved

when the ambient temperature stays below the desired maximum junction temperature. If the ambient temperature continues to rise past the programmed maximum junction temperature, the LEDs current will be reduced to approximately 5% of the full LED current.

While this feature is intended to directly protect the LT3598, it can also be used to derate the LED current at high temperatures. Since there is a direct relationship between the LED temperature and LT3598 junction temperature, the TSET function also provides some LED current derating at high temperatures.

Two external resistors program the maximum IC junction temperature using a resistor divider from the V_{REF} pin, as shown in Figure 8. Choose the ratio of R1 and R2 for the desired junction temperature. Figure 9 shows the relationship of T_{SET} voltage to junction temperature, and Table 6 shows commonly used values for R1 and R2.

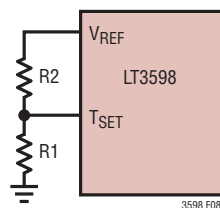

Figure 8. Programming the T_{SET} Pin

Table 6. T_{SET} Junction Temperature

T _J (°C)	R1	R2
90	100k	67.7k
100	100k	63.3k
110	100k	59k
120	100k	54.9k

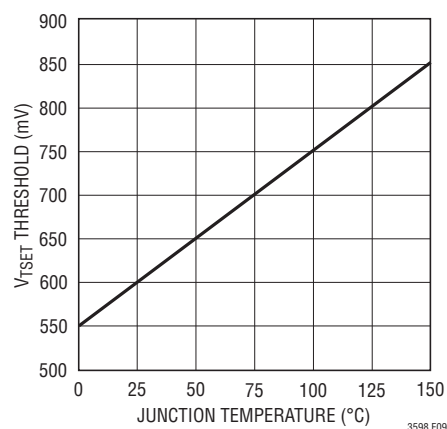

Figure 9. T_{SET} Pin Threshold

APPLICATIONS INFORMATION

Programming Switching Frequency

The switching frequency of the LT3598 should be programmed between 200kHz and 2.5MHz by an external resistor connected between the RT pin and ground. Do not leave this pin open. See Table 7 and Figure 10 for resistor values and corresponding frequencies.

Selecting the optimum switching frequency depends on several factors. Inductor size is reduced with higher frequency, but efficiency drops slightly due to higher switching losses. In addition, some applications require very high duty cycles to drive a large number of LEDs from a low supply. Low switching frequency allows a greater operational duty cycle and, hence, a greater number of LEDs to be driven. In each case, the switching frequency can be tailored to provide the optimum solution. When programming the switching frequency, the total power losses within the IC should be considered.

Table 7. Switching Frequency

SWITCHING FREQUENCY (MHz)	RT (k)
2.5	14.7
2	20.5
1.5	29.4
1	51.1
0.5	105
0.2	301

Switching Frequency Synchronization

The nominal operating frequency of the LT3598 is programmed using a resistor from the RT pin to ground and can be controlled over a 200kHz to 2.5MHz range. In addition, the internal oscillator can be synchronized to an external clock applied to the SYNC pin. The synchronizing clock signal input to the LT3598 must have a frequency between 240kHz and 3MHz, a duty cycle between 20% and 80%, a low state below 0.4V and a high state above 1.5V. Synchronization signals outside of these parameters will cause erratic switching behavior. For proper operation, an RT resistor should be chosen to program a switching frequency 20% slower than the SYNC pulse frequency. Synchronization occurs at a fixed delay after the rising edge of SYNC.

The SYNC pin should be grounded if the clock synchronization feature is not used. When the SYNC pin is grounded, the internal oscillator generates switching frequency to the converter.

Soft-Start and Switching Frequency Foldback

For many applications, it is necessary to minimize the inrush current at start-up. The LT3598's soft-start circuit significantly reduces the start-up current spike and output voltage overshoot. Before the SS pin voltage reaches 1V, the switching frequency will also fold back proportional to the SS pin voltage. A typical value for the soft-start capacitor is 10nF.

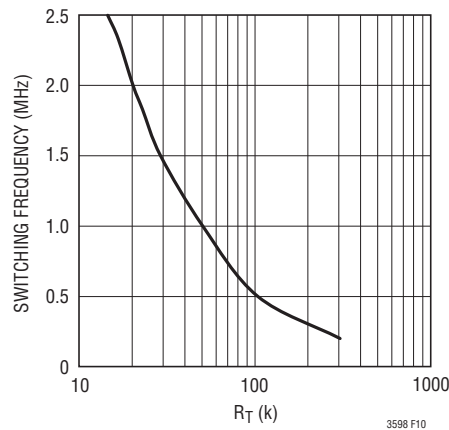

Figure 10. Switching Frequency

APPLICATIONS INFORMATION

OPENLED FLAG

The $\overline{\text{OPENLED}}$ pin is an open-collector output and needs an external resistor tied to a supply (see Figure 11). If any LED string is open during normal operation, the $\overline{\text{OPENLED}}$ pin will be pulled down.

The $\overline{\text{OPENLED}}$ flag is only activated after the first PWM edge. The open LED detection is enabled only when the PWM signal is enabled. There is a delay for $\overline{\text{OPENLED}}$ flag generation when the PWM signal is enabled to avoid generating a spurious flag signal. The maximum current the $\overline{\text{OPENLED}}$ can sink is typically 2mA.

During start-up (see the Operation section), the open LED detection is disabled. If an LED string is not used and tied to V_{OUT} , the string will not be in any fault detection.

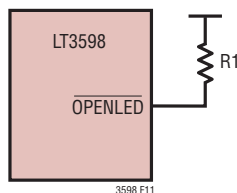

Figure 11. $\overline{\text{OPENLED}}$ Connection

Loop Compensation

The LT3598 has an internal transconductance error amplifier for LED current regulation whose V_C output compensates the control loop. During an open LED event where all LED strings are open, the V_C node also compensates the control loop. The external inductor, output capacitor, and the compensation resistor and capacitor determine the loop stability. The inductor and output capacitor are

chosen based on performance, size and cost. The compensation resistor and capacitor at V_C are selected to optimize control loop stability. For typical LED applications, a 15nF compensation capacitor in series with a 3k resistor at V_C is adequate.

Thermal Considerations

The LT3598 provides six channels for LED strings with internal NPN devices serving as constant-current sources. When LED strings are regulated, the lowest LED pin voltage is typically 0.8V. The higher the programmed LED current, the more power dissipation in the LT3598. For 30mA LED programming current with a 100% PWM dimming ratio, at least 144mW is dissipated within the IC due to current sources. If the forward voltages of the six LED strings are very dissimilar, there can be significant power dissipation. Thermal calculations shall include the power dissipation on current sources in addition to conventional switch DC loss, switch AC loss and input quiescent loss. For best efficiency, it is recommended that all channels have the same number of LEDs, and each string has a similar voltage drop across the LEDs.

Board Layout Considerations

As with all switching regulators, careful attention must be paid to the PCB board layout and component placement. To prevent electromagnetic interference (EMI) problems, proper layout of high frequency switching paths is essential. Minimize the length and area of all traces connected to the switching node pin (SW). Always use a ground plane under the switching regulator to minimize interplane coupling. Good grounding is essential in LED fault detection.

TYPICAL APPLICATIONS

LED Driver for 40 White LEDs with Two Channels Unused

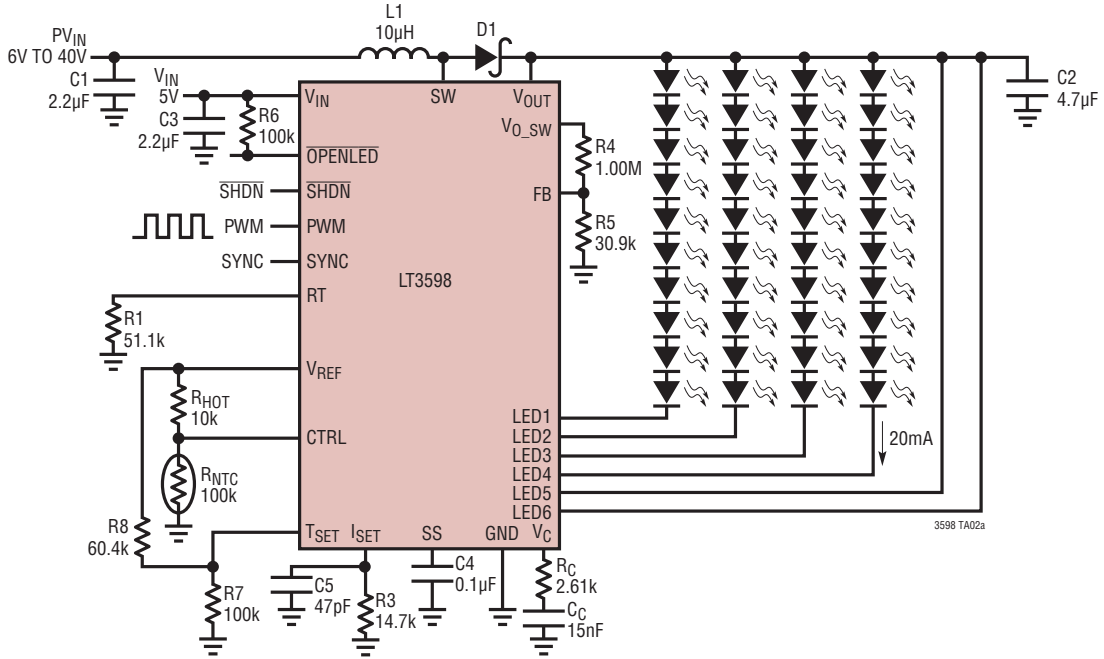

- C1: TAIYO YUDEN GMK325BJ225ML
- C2: MURATA GRM32ER71H475K
- C3: TAIYO YUDEN LMK212BJ225MG
- D1: DIODES, INC. B240A
- L1: WÜRTH ELEKTRONIK 74477410
- R_{NTC}: MURATA NCP18WF104J03RB

Efficiency (PWM Dimming)

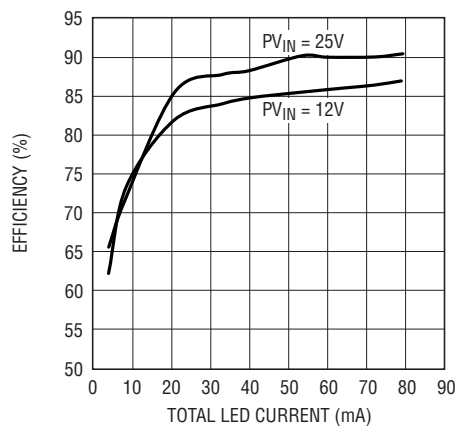

3598 TA02b

TYPICAL APPLICATIONS

LED Driver for 30 White LEDs with 60mA Each String

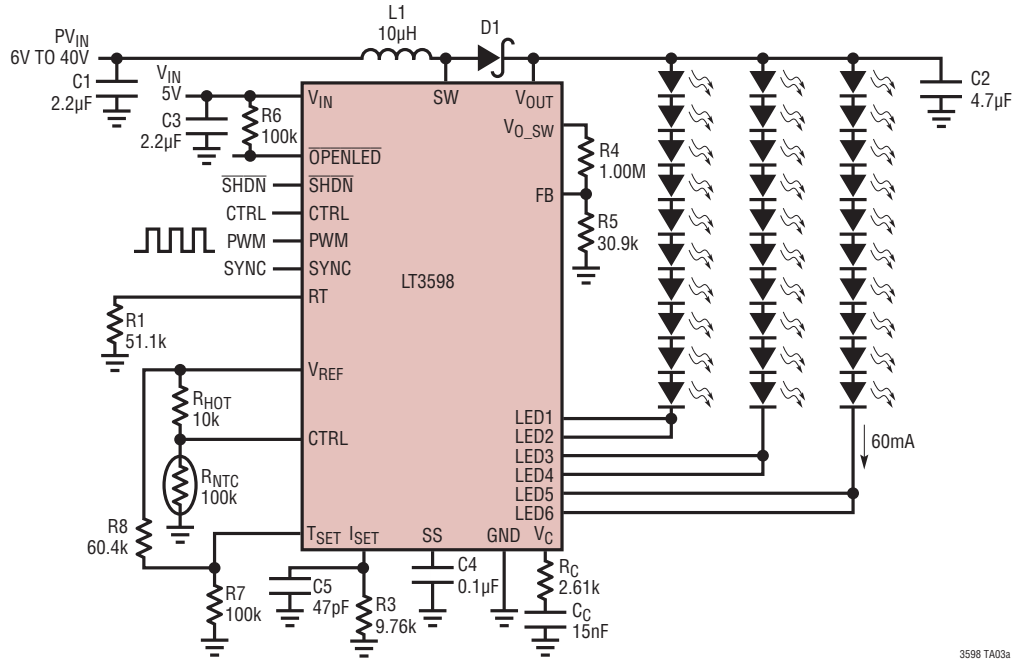

- C1: TAIYO YUDEN GMK325BJ225ML
- C2: MURATA GRM32ER71H475KA88L
- C3: TAIYO YUDEN LMK212BJ225MG
- D1: VISHAY SS3H9
- L1: WÜRTH ELEKTRONIK 744777410
- R_{NTC}: MURATA NCP18WF104J03RB

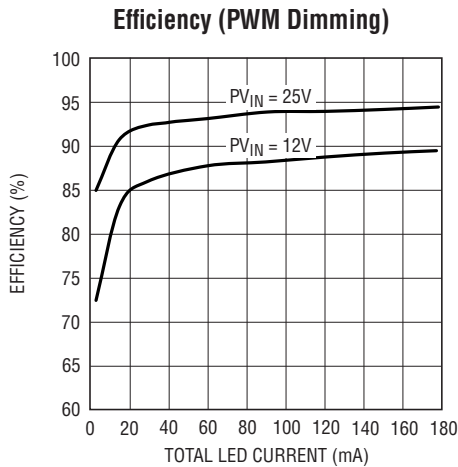

Dimming Range (1000:1 PWM) at 125°C Junction Temperature, 10ms Period

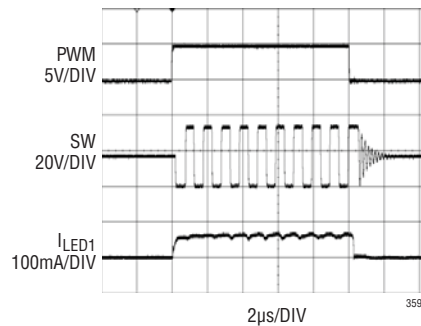

TYPICAL APPLICATIONS

Auto Battery Powered Driver for 20 LEDs with 90mA Each String

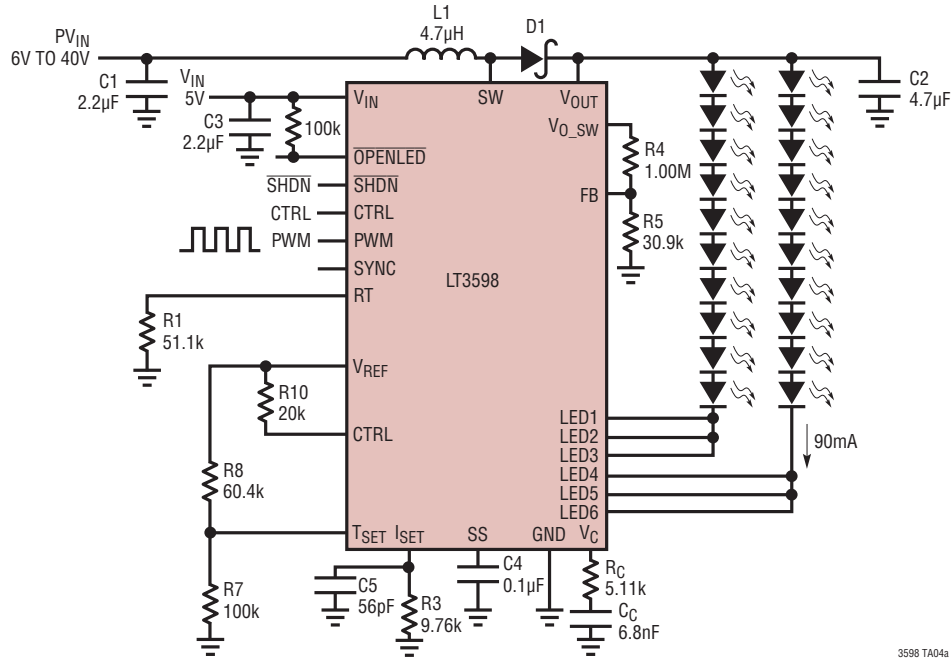

- C1: NIPPON CHEMI-CON KTS500B225M32NOT00
- C2: MURATA GRM32ER71H475KA88L
- C3: TAIYO YUDEN LMK212BJ225MG
- D1: VISHAY SS3H9
- L1: WÜRTH ELEKTRONIK 7447785004

Efficiency

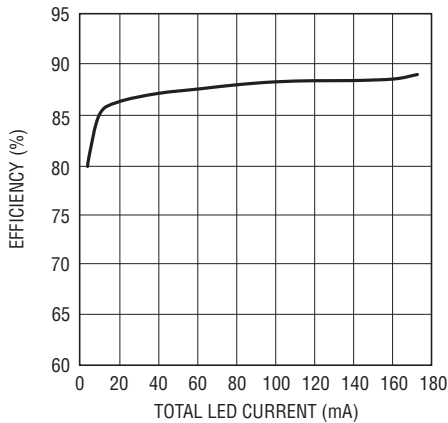

3598 TA04b

**Dimming Range 1000:1 PWM,
10ms Period (125°C Junction Temperature)**

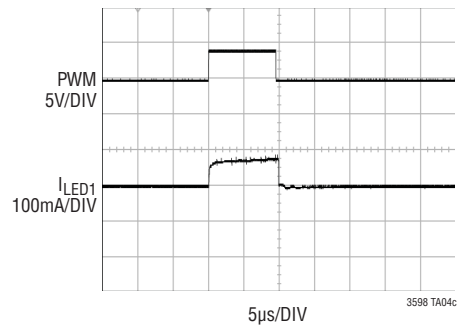

3598 TA04c

PACKAGE DESCRIPTION

UF Package
24-Lead Plastic QFN (4mm × 4mm)
 (Reference LTC DWG # 05-08-1697)

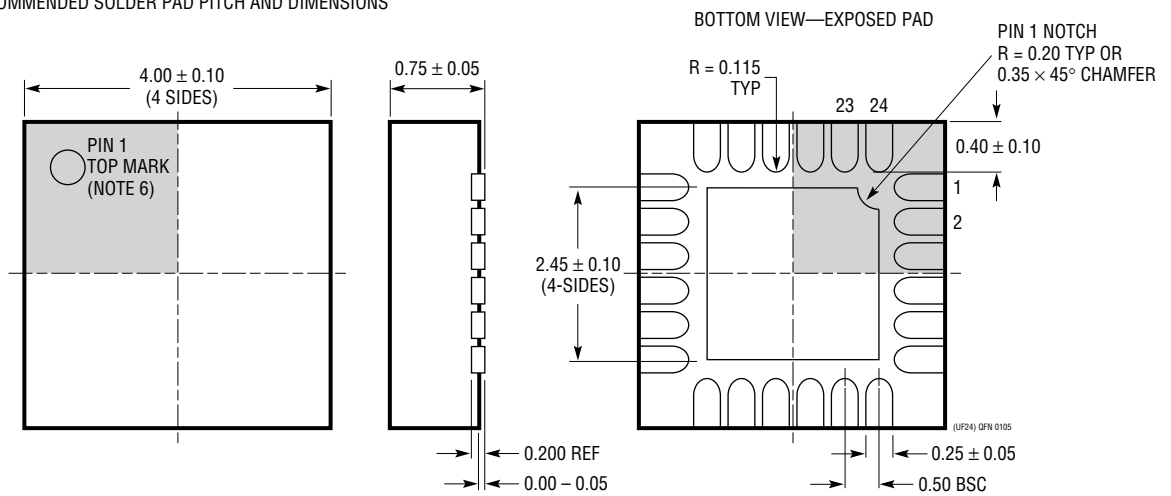
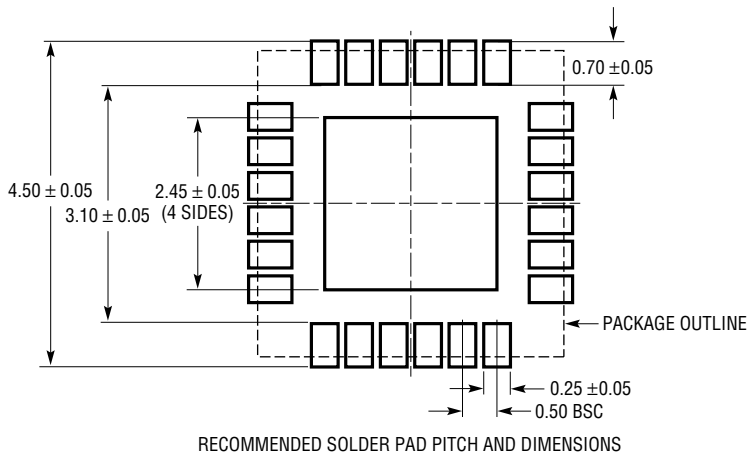

- NOTE:
1. DRAWING PROPOSED TO BE MADE A JEDEC PACKAGE OUTLINE MO-220 VARIATION (WGGD-X)—TO BE APPROVED
 2. DRAWING NOT TO SCALE
 3. ALL DIMENSIONS ARE IN MILLIMETERS
 4. DIMENSIONS OF EXPOSED PAD ON BOTTOM OF PACKAGE DO NOT INCLUDE MOLD FLASH. MOLD FLASH, IF PRESENT, SHALL NOT EXCEED 0.15mm ON ANY SIDE, IF PRESENT
 5. EXPOSED PAD SHALL BE SOLDER PLATED
 6. SHADED AREA IS ONLY A REFERENCE FOR PIN 1 LOCATION ON THE TOP AND BOTTOM OF PACKAGE

TYPICAL APPLICATION

90% Efficient LED Driver for 60 White LEDs

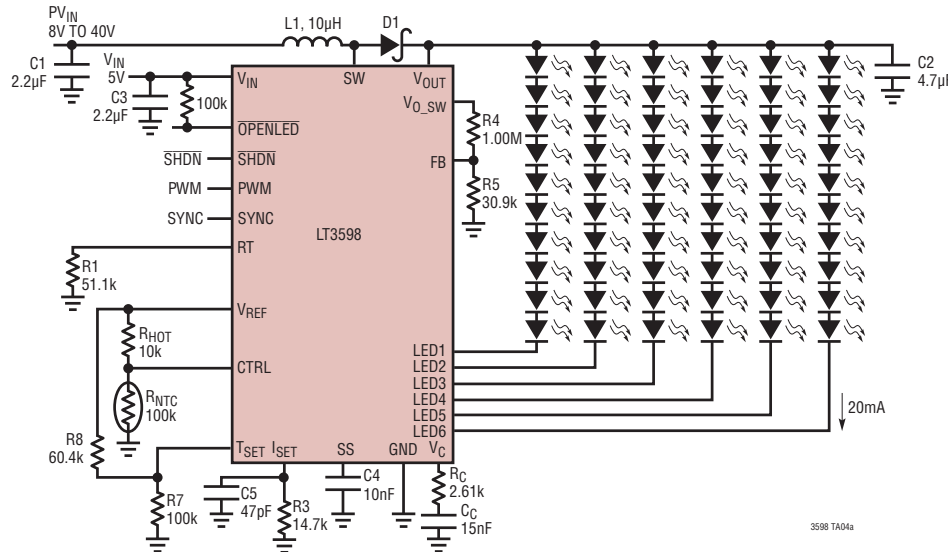

LED Current Matching vs Temperature

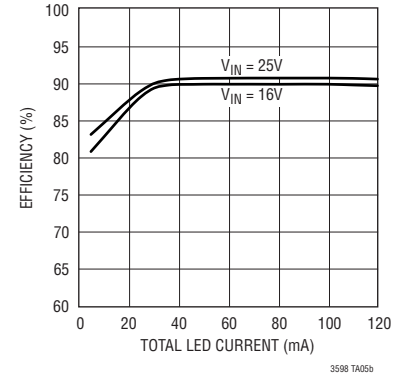

RELATED PARTS

PART NUMBER	DESCRIPTION	COMMENTS
LT3474/ LT3474-1	36V, 1A (ILED), 2MHz, Step-Down LED Driver	VIN: 4V to 36V, VOUT(MAX) = 13.5V, True Color PWM Dimming = 400:1, ISD < 1µA, TSSOP-16E Package
LT3475/ LT3475-1	Dual 1.5A (ILED), 36V, 2MHz, Step-Down LED Driver	VIN: 4V to 36V, VOUT(MAX) = 13.5V, True Color PWM Dimming = 3000:1, ISD < 1µA, TSSOP-20E Package
LT3476	Quad Output 1.5A, 2MHz High Current LED Driver with 1000:1 Dimming	VIN: 2.8V to 16V, VOUT(MAX) = 36V, True Color PWM Dimming = 1000:1, ISD < 10µA, 5mm × 7mm QFN-10 Package
LT3477	3A, 42V, 3MHz Boost, Buck-Boost, Buck LED Driver	VIN: 2.5V to 25V, VOUT(MAX) = 40V, Dimming = Analog/PWM, ISD < 1µA, QFN and TSSOP20E Packages
LT3478/LT3478-1	4.5A, 42V, 2.5MHz High Current LED Driver with 3000:1 Dimming	VIN: 2.8V to 36V, VOUT(MAX) = 42V, True Color PWM Dimming = 3000:1, ISD < 3µA, TSSOP16E Package
LT3486	Dual 1.3A, 2MHz High Current LED Driver	VIN: 2.5V to 24V, VOUT(MAX) = 36V, True Color PWM Dimming = 1000:1, ISD < 1µA, 5mm × 3mm DFN and TSSOP-16E Packages
LT3496	45V, 2.1MHz 3-Channel (ILED = 1A) Full Featured LED Driver	VIN: 3V to 30V (40VMAX), VOUT(MAX) = 45V, True Color PWM Dimming = 3000:1, ISD < 1µA, 4mm × 3mm QFN-28 Package
LT3497	Dual 2.3MHz, Full Function LED Driver with Integrated Schottkys and 250:1 True Color PWM Dimming	VIN: 2.5V to 10V, VOUT(MAX) = 32V, IQ = 6mA, ISD < 12µA, 2mm × 3mm DFN-10 Package
LT3498	2.3MHz, 20mA LED Driver and OLED Driver with Integrated Schottky	VIN: 2.5V to 12V, VOUT(MAX) = 32V, IQ = 1.65mA, ISD < 9µA, 2mm × 3mm DFN-10 Package
LT3518/LT3517	2.3A/1.3A 45V, 2.5MHz Full Featured LED Driver with True Color PWM Dimming	VIN: 3V to 30V (40VMAX), VOUT(MAX) = 42V, True Color PWM Dimming = 3000:1, ISD < 5µA, 4mm × 4mm QFN-16 Package
LT3590	48V, 850kHz 50mA Buck Mode LED Driver	VIN: 4.5V to 55V, Dimming = 200:1 True Color PWM, ISD < 15µA, 2mm × 2mm DFN-6 and SC70 Packages
LT3592	36V, 2.2MHz, 500mA Buck Mode LED Driver	VIN: 3.6V to 36V, True Color PWM Dimming = 10:1, ISD < 1µA, 2mm × 3mm DFN-10 and MSOP-10E Packages
LT3595	45V, 2.5MHz 16-Channel Full Featured LED Driver	VIN: 4.5V to 55V, VOUT(MAX) = 45V, True Color PWM Dimming = 5000:1, ISD < 1µA, 5mm × 9mm QFN-56 Package