

## FEATURES

- True Color PWM™ Delivers Constant Color with 400:1 Dimming Ratio
- Wide Input Range: 4V to 36V
- Up to 1A LED Current
- Adjustable Control of LED Current
- High Output Current Accuracy is Maintained Over a Wide Range from 35mA to 1A
- Open LED and Short-Circuit Protection
- Grounded Cathode Connection
- Small Footprint, Low Profile (15mm × 9mm × 2.82mm) Surface Mount LGA Package

## APPLICATIONS

- Automotive and Avionic Lighting
- Architectural Detail Lighting
- Display Backlighting
- Constant Current Sources

LT, LT, LTC and LTM are registered trademarks of Linear Technology Corporation.  $\mu$ Module is a trademark of Linear Technology Corporation. All other trademarks are the property of their respective owners.

## DESCRIPTION

The LTM<sup>®</sup>8040 is a fixed frequency 1A step-down DC/DC  $\mu$ Module™ designed to operate as a constant current source. Internal circuitry monitors the output current to provide accurate current regulation, which is ideal for driving high current LEDs. High output current accuracy is maintained over a wide current range, from 35mA to 1A, allowing a wide dimming range over an output voltage range of 2.4V to 13V. Unique PWM circuitry allows a dimming range of 400:1, avoiding the color shift normally associated with LED current dimming.

With its wide input range of 4V to 36V, the LTM8040 regulates a broad array of power sources, from 4-cell batteries and 5V logic rails to unregulated wall transformers, lead acid batteries and distributed power supplies.

The LTM8040 is packaged in a thermally enhanced, compact (15mm × 9mm) and low profile (2.82mm) molded Land Grid Array (LGA) package suitable for automated assembly by standard surface mount equipment. The LTM8040 is Pb-free and RoHS compliant.

## TYPICAL APPLICATION

1A LED Driver  $\mu$ Module

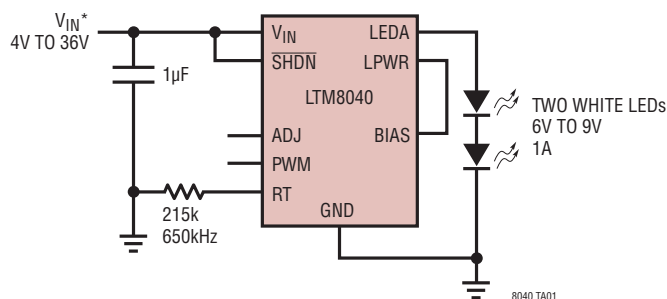

\*RUNNING VOLTAGE. SEE APPLICATION INFORMATION FOR START-UP REQUIREMENTS

Efficiency

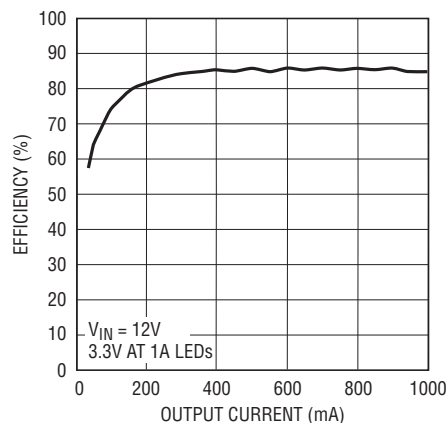

# LTM8040

## ABSOLUTE MAXIMUM RATINGS

(Note 1)

$V_{IN}$ .....	36V
BIAS .....	25V
BIAS + $V_{IN}$ .....	51V
LEDA .....	15V
PWM .....	10V
ADJ .....	6V
SHDN .....	36V
SHDN Above $V_{IN}$ .....	6V
BIAS Current .....	1A
Internal Operating Temperature (Note 2)....	-40 to 125°C
Storage Temperature Range.....	-45 to 125°C

## PIN CONFIGURATION

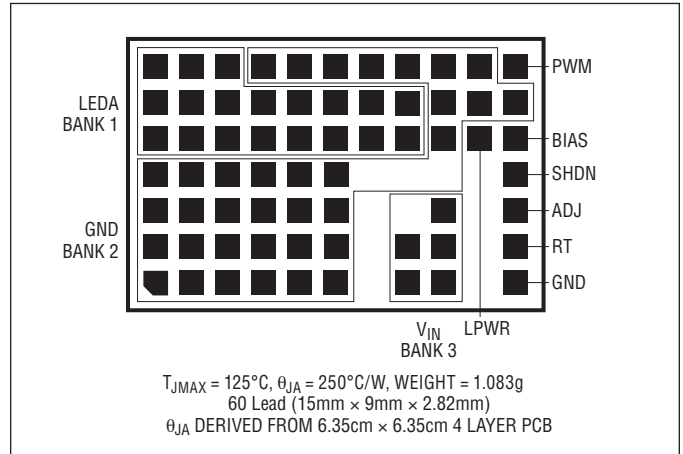

## ORDER INFORMATION

LEAD FREE FINISH	PART MARKING*	PACKAGE DESCRIPTION	TEMPERATURE RANGE (NOTE 3)
LTM8040EV#PBF	LTM8040V	60-Lead 15mm x 9mm LGA Package	0°C to 125°C
LTM8040IV#PBF	LTM8040V	60-Lead 15mm x 9mm LGA Package	-40°C to 125°C

Consult LTC Marketing for parts specified with wider operating temperature ranges. \*The temperature grade is identified by a label on the shipping container. Consult LTC Marketing for information on non-standard lead based finish parts.

For more information on lead free part marking, go to: <http://www.linear.com/leadfree/>

## ELECTRICAL CHARACTERISTICS

The ● denotes the specifications which apply over the full operating temperature range, otherwise specifications are at  $T_A = 25^{\circ}\text{C}$ .  $V_{IN} = 12\text{V}$ , BIAS = LPWR,  $V_{OUT} = 4\text{V}$ , ADJ open, RT open,  $V_{PWM} = 5\text{V}$ , unless otherwise noted (Note 3).

PARAMETER	CONDITIONS	MIN	TYP	MAX	UNITS	
Minimum Input Voltage		●	3.5	4	V	
Input Quiescent Current	Not Switching		2.6	4	mA	
Shutdown Current	SHDN = 0.3V, BIAS = 0V, LEDA = 0V		0.01	2	μA	
LEDA Current	ADJ open $R_{ADJ} = 5.11\text{k}$	●	0.98	1	1.02	A
		●	0.965		1.035	A
		●	0.49	0.5	0.51	A
		●	0.481		0.525	A
ADJ Bias Current	ADJ = 0V, Current flows out of pin		24.5		μA	
ADJ Pull-up Resistor		5	5.11	5.22	kΩ	
Switching Frequency	RT open	470	500	530	kHz	
SHDN Threshold	$V_{IH}$ $V_{IL}$	2.60		1	V	
					V	
PWM Threshold	$V_{IH}$ $V_{IL}$	0.4		1.2	V	
					V	

8040p

**ELECTRICAL CHARACTERISTICS** The ● denotes the specifications which apply over the full operating temperature range, otherwise specifications are at  $T_A = 25^\circ\text{C}$ .  $V_{IN} = 12\text{V}$ ,  $\text{BIAS} = \text{LPWR}$ ,  $V_{OUT} = 4\text{V}$ ,  $\text{ADJ open}$ ,  $\text{RT open}$ ,  $V_{\text{PWM}} = 5\text{V}$ , unless otherwise noted (Note 3).

PARAMETER	CONDITIONS	MIN	TYP	MAX	UNITS
LEDA Clamp Voltage		13.2		14.5	V
Minimum BIAS Voltage			2.0	2.6	V

**Note 1:** Stresses beyond those listed under Absolute Maximum Ratings may cause permanent damage to the device. Exposure to any Absolute Maximum Rating condition for extended periods may affect device reliability and lifetime.

**Note 2:** This  $\mu\text{Module}$  includes overtemperature protection that is intended to protect the device during momentary overload conditions. Junction temperature will exceed  $125^\circ\text{C}$  when overtemperature protection is active. Continuous operation above the specified maximum operating junction temperature may impair device reliability.

**Note 3:** The LTM8040E is guaranteed to meet performance specifications from  $0^\circ\text{C}$  to  $125^\circ\text{C}$  internal. Specifications over the full  $-40^\circ\text{C}$  to  $125^\circ\text{C}$  internal operating temperature range are assured by design, characterization and correlation with statistical process controls. The LTM8040I is guaranteed to meet specifications over the full  $-40^\circ\text{C}$  to  $125^\circ\text{C}$  internal operating temperature range. Note that the maximum internal temperature is determined by specific operating conditions in conjunction with board layout, the rated package thermal resistance and other environmental factors.

**TYPICAL PERFORMANCE CHARACTERISTICS**

Efficiency - Single 2.66V at 1A LED

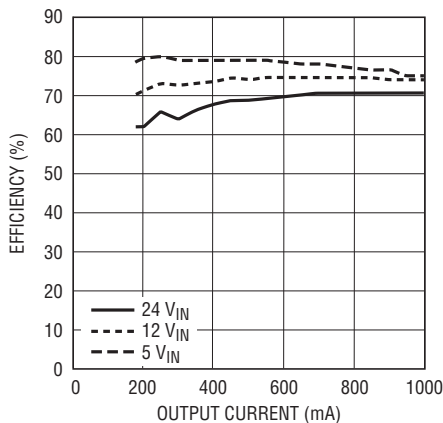

8040 G01

Efficiency - Three 2.66V at 1A LEDs

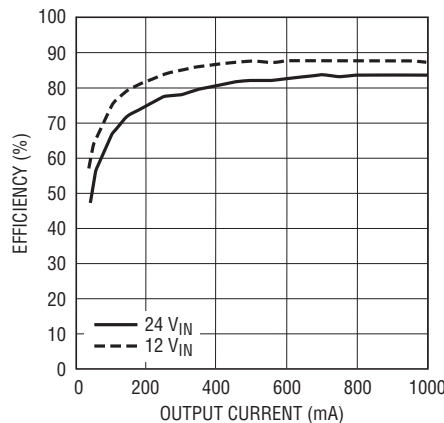

8040 G02

Efficiency - Four 2.66V at 1A LEDs

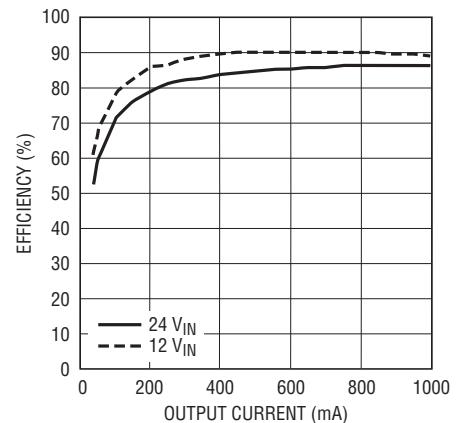

8040 G03

Efficiency - Single 3.3V at 1A LED

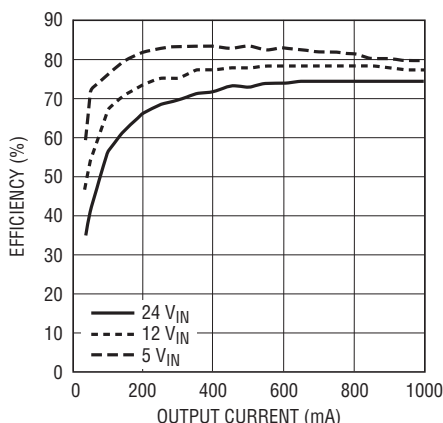

8040 G04

Efficiency - Two 3.3V at 1A LEDs

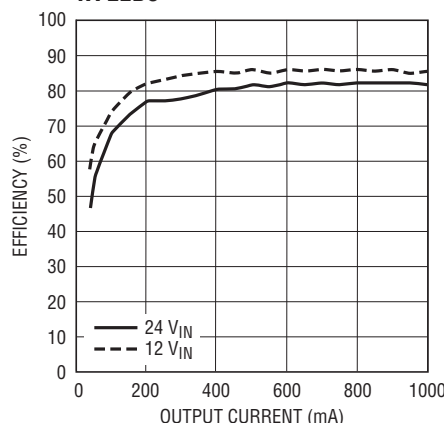

8040 G05

Efficiency - (3 x 3.3V at 1A LEDs)

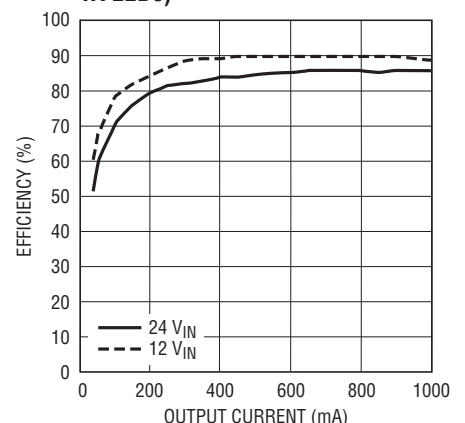

8040 G06

8040p

## TYPICAL PERFORMANCE CHARACTERISTICS

**Minimum Running Voltage vs Output Voltage 2.7V at 1A LEDs**

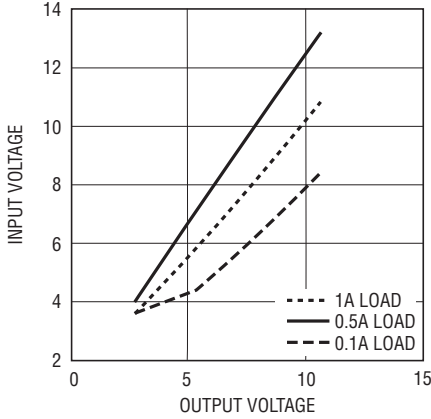

**Minimum Running Voltage vs Output Voltage 3.3V at 1A LEDs**

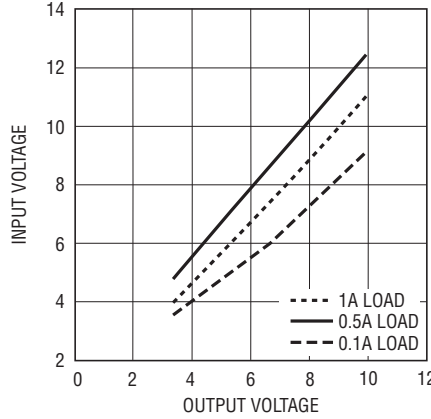

**Minimum Start Voltage vs Load 2.7V at 1A LEDs**

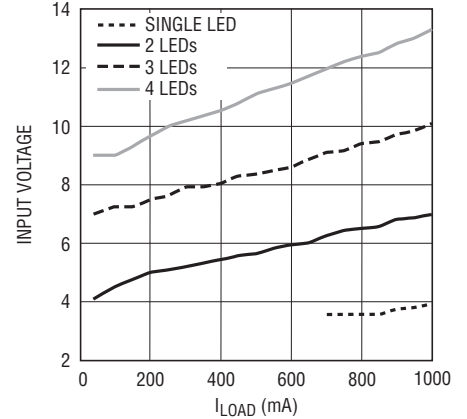

**Minimum Start Voltage vs Load 3.3V at 1A LEDs**

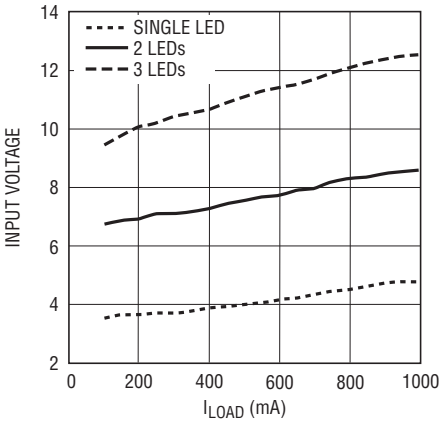

**SHDN Current vs Voltage**

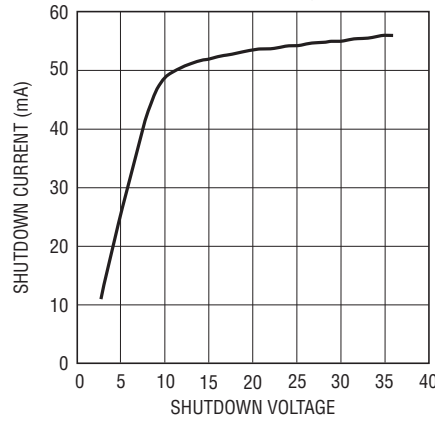

**BIAS Current vs Load Current 12V<sub>IN</sub>, Single 2.7V at 1A LED**

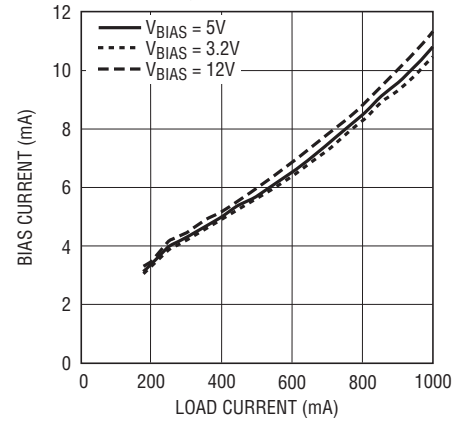

**BIAS Current vs Load Current 24V<sub>IN</sub>, Three 3.3V at 1A LEDs**

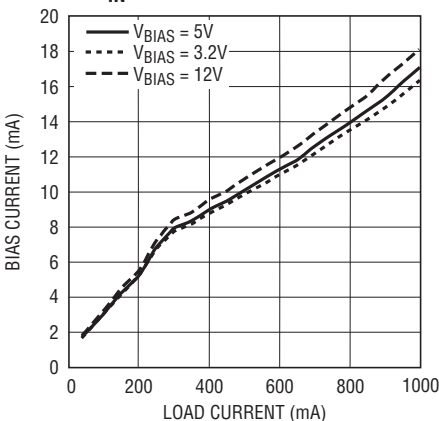

**Input Current vs Input Voltage Output Short Circuited**

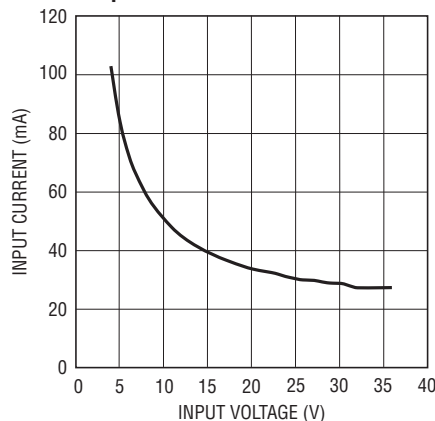

**Temp Rise vs Load 2.7V at 1A LEDs, 12V<sub>IN</sub>**

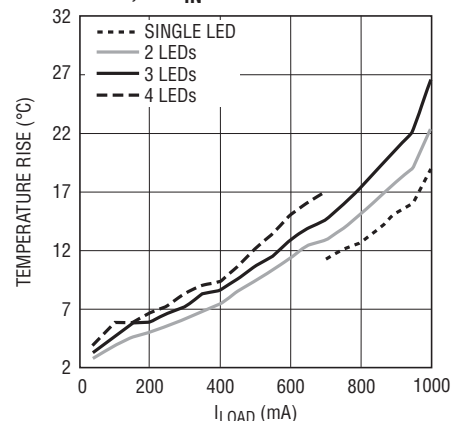

## TYPICAL PERFORMANCE CHARACTERISTICS

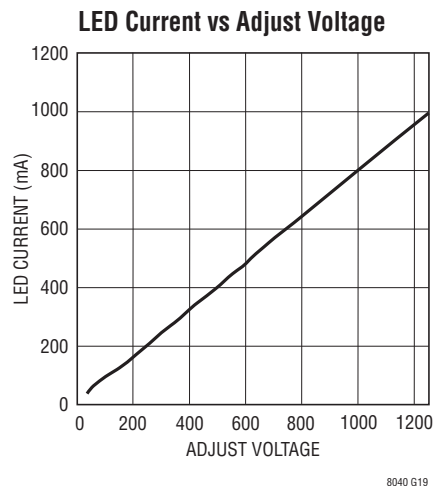
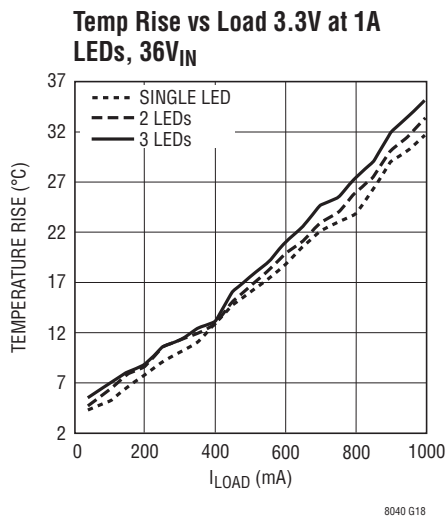
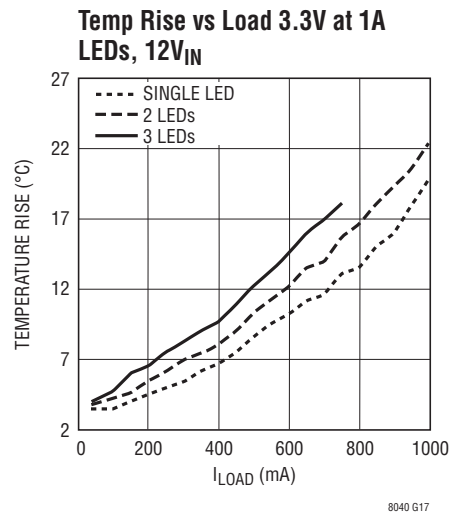
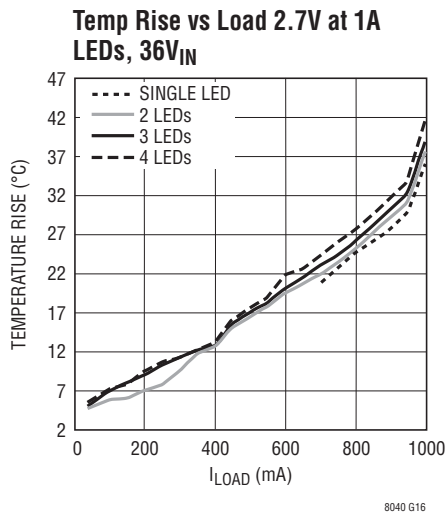

## PIN FUNCTIONS

**LEDA (Bank 1):** This pin is the regulated current source of the LTM8040. Connect the anode of the LED string to this pin. This voltage must be at least 2.4V for accurate current regulation.

**SHDN (Pin L4):** The  $\overline{\text{SHDN}}$  pin is used to shut down the switching regulator and the internal bias circuits. The 2.65V switching threshold can function as an accurate undervoltage lockout. Pull below 0.3V to shut down the LTM8040. Pull above 2.65V to enable the LTM8040. Tie to  $V_{\text{IN}}$  if the SHDN function is unused.

**BIAS (Pin L5):** The BIAS pin connects through an internal Schottky diode to provide power to internal housekeeping circuits. Connect to a voltage source (usually LPWR or  $V_{\text{IN}}$ ) greater than 3.2V. Note that this pin is adjacent to the LPWR pin to ease layout. If this pin is powered by an external power source, a decoupling cap may be necessary.

**LPWR (Pin K5):** This is the output of the buck regulator that sources the LED current. If the LEDA voltage is above 3.2V, connect this pin to BIAS. It is pinned out primarily for the convenience of the user. If it is not used, leave this

## PIN FUNCTIONS

pin floating. Please refer to the Applications Information section for details.

**PWM (Pin L7):** Input Pin for PWM Dimming Control. A PWM signal above 0.9V (ON threshold) turns the on output current source, while a PWM signal below 0.5V shuts it down. If the application does not require PWM dimming, then the PWM pin can be left either open (an internal 10µA source current pulls PWM high) or pulled up to a voltage source between 1.2V and 10V.

**V<sub>IN</sub> (Bank 3):** The V<sub>IN</sub> pin supplies current to the LTM8040's internal power converter and other circuitry. It must be locally bypassed with a high quality (low ESR) capacitor.

**ADJ (Pin L3):** Use the ADJ pin to scale the LEDA output current below 1A by either applying a voltage source or by connecting a resistor to GND. This pin is internally pulled up to a 1.25V reference through a 5.11K resistor, so ensure that the voltage source can drive a 5.11K impedance. If applying a voltage to ADJ, the LEDA current follows the

formula:  $I_{LED} = 1A \cdot ADJ / 1.25V$ . If connecting a resistor to GND, the resistor value should be  $R = 5.11 \cdot I_{LED} / (1Amp - I_{LED})$ , where R is in KΩ and I<sub>LED</sub> is the desired current out of LEDA in Amps. Make sure that the voltage at LEDA is at least 2.4V.

**RT (Pin L2):** The RT pin is used to set the internal oscillator frequency. An 80.6k resistor has already been installed inside the LTM8040 to default switching frequency to 500kHz. If no modification of the switching frequency is necessary, leave this pin floating. Otherwise, a parallel resistor applied from RT to GND will raise the switching frequency. See table 2 for details.

**GND (Bank 2):** Tie all GND pins directly to a local ground plane. These pins serve as both signal and power return to the LTM8040 µModule, as well as providing the primary thermal path for heat dissipation within the unit. See the Applications Information section for more information about heat-sinking and printed circuit board layout.

## BLOCK DIAGRAM

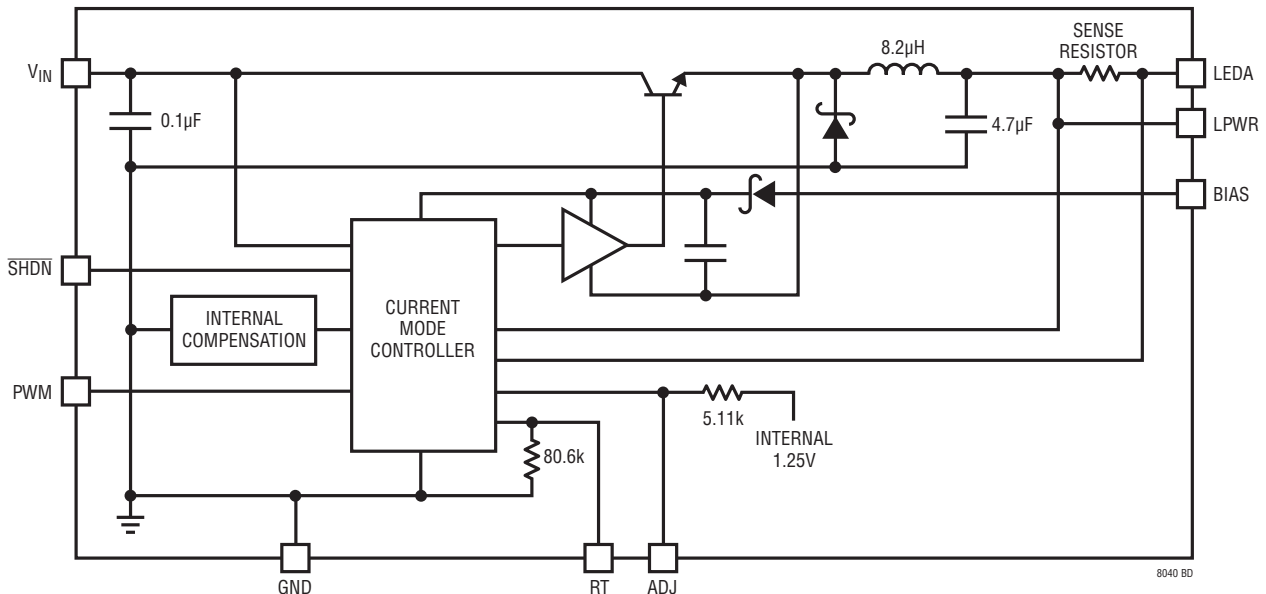

## OPERATION

The LTM8040 is a constant frequency, current mode converter capable of generating a constant 1A output intended to drive LEDs or other applications where a constant current is required.

Operation can be best understood by referring to the Block Diagram. The power stage is step down converter that regulates the output current by reading the voltage across a power sense resistor that is in series with the output.

If the  $\overline{\text{SHDN}}$  pin is tied to ground, the LTM8040 is shut down and draws minimal current from the input source tied to  $V_{\text{IN}}$ . If the  $\overline{\text{SHDN}}$  pin exceeds 1.5V, the internal bias circuits turn on, including the internal regulator, reference, and oscillator. When the  $\overline{\text{SHDN}}$  pin exceeds 2.65V, the switching regulator will begin to operate.

There are two means to dim a LED with the LTM8040. The first is to adjust the current on the LEDA output via a voltage on the ADJ pin. The ADJ pin is internally pulled up to a precision 1.25V reference through a 1% 5.11K resistor. Leaving the ADJ pin floating sets the LED pin current to 1A. Reducing the voltage below 1.25V on the ADJ pin proportionally reduces the current flowing out of LEDA. This can be accomplished by connecting a resistor from the ADJ pin to GND, forming a divider network with the internal 5.11K resistor. LED pin current can also be programmed by tying the ADJ pin directly to a voltage source. For proper operation, make sure that LEDA is at least 2.4V at the desired operating point.

The other means by which the LTM8040 can dim a LED is with pulse width modulation using the PWM pin and an optional external NFET. If the PWM pin is unconnected or pulled high, the part operates nominally. If the PWM pin is pulled low, the LTM8040 stops switching and the internal control circuitry is held in its present state. Cir-

cuitry drawing current from the LPWR pin is also disabled. This way, the LTM8040 “remembers” the current sourced from the LEDA output until PWM is pulled high again. This leads to a highly linear relationship between pulse width and output light, allowing for a large and accurate dimming range.

The RT pin allows programming of the switching frequency. The LTM8040 is shipped with 80.6K on this pin to GND, yielding a default switching frequency of 500KHz. For applications requiring a faster switching frequency, apply another resistor in parallel, from RT to GND. Refer to table 2 for the frequencies that correspond to the applied external resistor values.

An external voltage is required at the BIAS pin to power internal circuitry. For proper operation, BIAS must be at least 3.2V. For many applications, BIAS should be tied to LWPR; if LWPR is below 3.2V, BIAS may be tied to  $V_{\text{IN}}$  or some other voltage source.

The switching regulator performs frequency foldback during overload conditions. An amplifier senses when LWPR is less than 2V and begins decreasing the oscillator frequency down from full frequency to 20% of the nominal frequency when  $V_{\text{OUT}} = 0\text{V}$ . The LPWR pin is less than 2V during startup, short circuit, and overload conditions, so the BIAS pin will be below the specified limit for efficient operation if the two pins are tied together. Frequency foldback helps limit internal power and thermal stresses under these conditions.

The LTM8040 is equipped with thermal protection that reduces the output LED current if the internal operating temperature is too high. This thermal protection is active above the 125°C temperature rating of the LTM8040, so continuous operation under this operating condition may impair reliability.

## APPLICATION INFORMATION

For most applications, the design process is straight forward, summarized as follows:

1. Look at Table 1 and find the row that has the desired input voltage range LED string voltage range and output current.
2. Apply the recommended  $C_{IN}$ ,  $R_T$  and  $R_{ADJ}$  values.
3. Connect BIAS as indicated.
4. Connect LEDA to the anode of the LED string.
5. Connect the remaining pins as needed by the system requirements.

While these component combinations have been tested for proper operation, it is incumbent upon the user to verify proper operation over the intended system's line, load and environmental conditions.

### Open LED Protection

The LTM8040 has internal open LED circuit protection. If the LED is absent or fails open, the LTM8040 clamps the voltage on the LEDA pin to 14V. The switching regulator then skips cycles to limit the input current. The input current and output voltage during an open LED condition is shown in the Typical Performance Characteristics section.

### Undervoltage Lockout

Undervoltage lockout (UVLO) is typically used in situations where the input supply is current limited, or has high source resistance. A switching regulator draws constant power from the source, so the source current increases as the source voltage drops. This looks like a negative resistance load to the source and can cause the source to current limit or latch low under low source voltage conditions.

UVLO prevents the regulator from operating at source voltages where this might occur. An internal comparator will force the part into shutdown when  $V_{IN}$  falls below 3.5V. An adjustable UVLO threshold is also realized through the  $\overline{SHDN}$  pin, as the internal comparator that performs this function has a 2.65V threshold. An internal resistor pulls 10.3 $\mu$ A to ground from the  $\overline{SHDN}$  pin at the UVLO threshold in order to provide hysteresis.

Choose resistors according to the following formula:

$$R2 = \frac{2.65V}{\frac{V_{UVLO} - 2.65V}{R1} - 10.3\mu A}$$

where  $V_{UVLO}$  is the desired UVLO Threshold

Suppose that the output needs to stay off until the input is above 8V.

$$V_{TH} = 8V$$

Let  $R1 = 100k$

$$R2 = \frac{2.65V}{\frac{8V - 2.65V}{100k} - 10.3\mu A} = 61.9$$

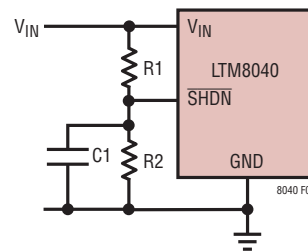

Figure 1. Undervoltage Lockout

Keep the connections from the resistors to the  $\overline{SHDN}$  pin short. If high resistance values are used, the  $\overline{SHDN}$  pin should be bypassed with a 1nF capacitor to prevent coupling problems from switching nodes.

### Setting the Switching Frequency

The LTM8040 uses a constant frequency architecture that can be programmed over a 500kHz to 2MHz range with a single external timing resistor from the  $R_T$  pin to ground. The current that flows into the timing resistor is used to charge an internal oscillator capacitor. The LTM8040 is configured such that the default frequency is 500kHz without adding any resistor. Many applications use this value. If another frequency is desired, a graph for selecting



## APPLICATION INFORMATION

the value of  $R_T$  for a given operating frequency is shown in the Typical Performance Characteristics section. Table 2 shows suggested  $R_T$  selections for a variety of switching frequencies.

**Table 2.  $R_T$  vs Frequency**

$R_T$ (k $\Omega$ )	Frequency (MHz)
13.0	2.00
16.0	1.84
18.7	1.70
24.9	1.50
29.4	1.37
35.8	1.25
54.9	1.00
75.0	0.90
88.7	0.85
137.0	0.75
175.0	0.68
215.0	0.65
487.0	0.57
open	0.50

### BIAS Pin Considerations

For proper operation, The BIAS pin must be powered by at least 3.2V. Figure 2 shows three ways to arrange the circuit. For outputs of 3.2V or higher, the standard circuit (Figure 2a) is best, because the circuit's efficiency is better for lower voltages above 3.2V. For output voltages below 3.2V, the BIAS pin can be tied to the input (Figure 2b) at the cost of some efficiency. Finally, the BIAS pin can be tied to another source that is at least 3.2V (Figure 2c). For example, if a 3.3V source is on whenever the LED is on, the BIAS pin can be connected to the 3.3V output. In all cases, be sure that the maximum voltage at the BIAS pin is both less than 25V and the sum of  $V_{IN}$  and BIAS is less than 51V. If BIAS is powered by a source other than LPWR, a local decoupling capacitor may be necessary. The value of the decoupling cap is dependent upon the source and PCB layout.

### Programming LED Current

The LED current can be set by adjusting the voltage on the ADJ pin. The ADJ pin is internally pulled up to a pre-

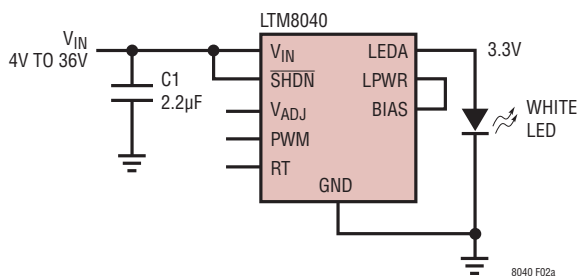

**Figure 2a. Tie BIAS to LPWR if it is Greater Than 2.6V**

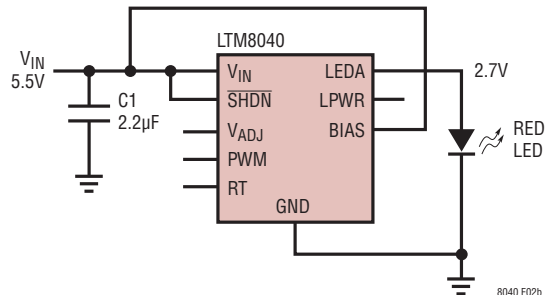

**Figure 2b. BIAS May be Tied to  $V_{IN}$  if LPWR is Below 2.6V**

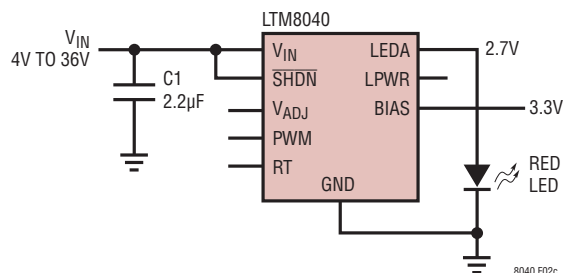

**Figure 2c. Tie BIAS to an External Power Source if Neither  $V_{IN}$  Nor LPWR are Suitable**

## APPLICATION INFORMATION

cision 1.25V voltage source through a 5.11K 1% resistor. This resistor makes it easy to adjust the LED current with a single external resistor. For a 1A LED current, leave the ADJ pin floating. For lower output currents, apply a resistor from ADJ to GND as shown in Figure 3, using the following formula:

$$R_{ADJ} = 5.11 \cdot I_{LED} / (1\text{Amp} - I_{LED}),$$

where  $R_{ADJ}$  is in  $k\Omega$  and  $I_{LED}$  is the desired current out of LEDA.

In order to have accurate LED current, a precision 1% resistor is recommended.

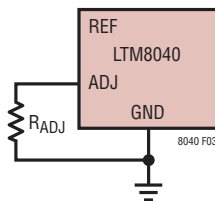

Figure 3. Setting ADJ with a Resistor

The LEDA voltage must be at least 2.4V for proper current regulation.

### Dimming Control

There are several different types of dimming control circuits. One dimming control circuit (Figure 4) changes the voltage on the ADJ pin by tying a low on-resistance FET to the resistor divider string. This allows the selection of two different LED currents. For reliable operation, program an LED current of no less than 35mA. The maximum current dimming ratio ( $I_{RATIO}$ )

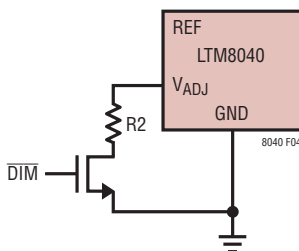

Figure 4. Dimming with an NFET and Resistor

can be calculated from the maximum LED current ( $I_{MAX}$ ) and the minimum LED current ( $I_{MIN}$ ) as follows:

$$\frac{I_{MAX}}{I_{MIN}} = I_{RATIO}$$

Another dimming control circuit (Figure 5) uses the PWM pin and an external NFET tied to the cathode of the LED. When the PWM signal goes low, the NFET turns off, disconnecting the LED from the internal current source and “freezing” the state of LTM8040 internal control and drive circuitry, but leaving the output capacitor of the internal step down converter charged. When the PWM pin goes high again, the LED current returns rapidly to its previous on state. This fast settling time allows the LTM8040 to maintain LED current regulation with PWM pulse widths as short as 40 $\mu$ s. It is also possible to not use an external NFET, but the output capacitor of the internal regulator will be discharged by the LED(s) and have to be charged up again when the current source turns back on. This will lengthen the minimum dimming pulse width, in turn reducing the PWM dimming frequency.

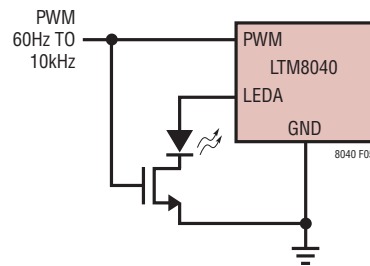

Figure 5. Dimming Using PWM Signal

The maximum PWM dimming ratio ( $PWM_{RATIO}$ ) can be calculated from the maximum PWM period ( $t_{MAX}$ ) and minimum PWM pulse width ( $t_{MIN}$ ) as follows:

$$\frac{t_{MAX}}{t_{MIN}} = PWM_{RATIO}$$

## APPLICATION INFORMATION

Total dimming ratio ( $DIM_{RATIO}$ ) is the product of the PWM dimming ratio and the current dimming ratio.

Example:  $I_{MAX} = 1A$ ,  $I_{MIN} = 0.1A$ ,  $t_{MAX} = 1.0ms$ ,  
 $t_{MIN} = 25\mu s$

$$I_{RATIO} = \frac{1A}{0.1A} = 10:1$$

$$PWM_{RATIO} = \frac{10ms}{25\mu s} = 400:1$$

$$DIM_{RATIO} = 10 \cdot 400 = 4000:1$$

### Minimum Input Voltage

The LTM8040 is a step down converter, so a minimum amount of headroom is required to keep the output in regulation. For most applications at full load, the input needs to be at least 1.5V above the desired output. In addition, it takes more input voltage to initially start than is required for continuous operation. This start voltage is also dependent on whether turn-on is controlled by the LTM8040's  $\overline{SHDN}$  pin or UVLO (that is, the  $\overline{SHDN}$  pin is tied to  $V_{IN}$ ). See Typical Performance Characteristics for details.

### Capacitor Selection Considerations

The  $C_{IN}$  and capacitor values in tables 1 and 2 are the minimum recommended values for the associated operating conditions. Applying capacitor values below those indicated in table 1 is not recommended, and may result in undesirable operation. Using larger values is generally acceptable, and can yield improved performance, if it is necessary. Again, it is incumbent upon the user to verify proper operation over the intended system's line, load and environmental conditions.

Ceramic capacitors are small, robust and have very low ESR. However, not all ceramic capacitors are suitable. X5R and X7R types are stable over temperature and applied voltage and give dependable service. Other types, including Y5V and Z5U have very large temperature and voltage coefficients of capacitance. In an application circuit they may have only a small fraction of their nominal capacitance resulting in much higher output voltage ripple than expected.

Ceramic capacitors are also piezoelectric. While the LTM8040 is a fixed frequency device, the internal regulators may skip cycles at light loads and extend the switching cycle on time as the input voltage falls towards the to output. Under either of these conditions, the LTM8040 can excite a ceramic capacitor at audio frequencies, generating audible noise.

If this audible noise is unacceptable, use a high performance electrolytic capacitor at the output. The input capacitor can be a parallel combination of a 4.7 $\mu$ F ceramic capacitor and a low cost electrolytic capacitor.

A final precaution regarding ceramic capacitors concerns the maximum input voltage rating of the LTM8040. A ceramic input capacitor combined with trace or cable inductance forms a high Q (under damped) tank circuit. If the LTM8040 circuit is plugged into a live supply, the input voltage can ring to twice its nominal value, possibly exceeding the device's rating. This situation is easily avoided by introducing a small series damping resistance into the circuit. This is most often taken care of by the presence of an electrolytic bulk capacitor in the board.

### High Temperature Considerations

The internal operating temperature of the LTM8040 must be lower than 125°C rating, so care should be taken in the layout of the circuit to ensure good heat sinking of the LTM8040. To estimate the junction temperature, approximate the power dissipation within the LTM8040 by applying the typical efficiency stated in this datasheet to the desired output power, or, if you have an actual module, by taking a power measurement. Then calculate the temperature rise of the LTM8040 junction above the surface of the printed circuit board by multiplying the module's power dissipation by the thermal resistance. The actual thermal resistance of the LTM8040 to the printed circuit board depends on the layout of the circuit board, but the thermal resistance given on page 2, which is based upon a 40.3cm<sup>2</sup> 4 layer FR4 PC board, can be used as a guide.

The LTM8040 is equipped with thermal protection that reduces the output LED current if the internal operating temperature is too high. This thermal protection is active above the 125°C temperature rating of the LTM8040, so

## APPLICATION INFORMATION

continuous operation under this operating condition may impair reliability.

### Layout Hints

Most of the headaches associated with PCB layout have been alleviated or even eliminated by the high level of integration of the LTM8040. The LTM8040 is nevertheless a switching power supply, and care must be taken to minimize EMI and ensure proper operation. Even with the high level of integration, you may fail to achieve specified operation with a haphazard or poor layout. See Figure 6 for a suggested layout. Ensure that the grounding and heatsinking are acceptable. A few rules to keep in mind are:

1. Place the  $C_{IN}$  capacitor as close as possible to the  $V_{IN}$  and GND connection of the LTM8040.

2. Connect all of the GND connections to as large a copper pour or plane area as possible on the top layer. Avoid breaking the ground connection between the external components and the LTM8040.
3. Use vias to connect the GND copper area to the board's internal ground plane. Liberally distribute these GND vias to provide both a good ground connection and thermal path to the internal planes of the printed circuit board.
4. If the application requires BIAS to be connected to the input voltage potential, tie BIAS to  $V_{IN}$ , but be careful not to break up the ground plane.

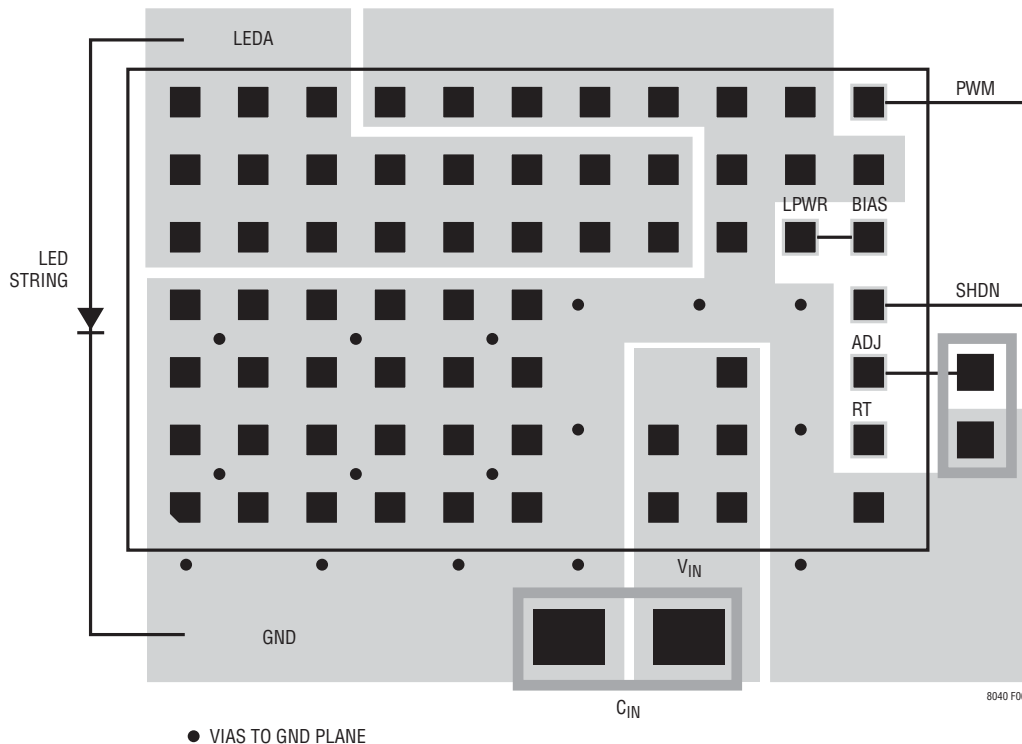

Figure 6. Suggested Layout

## APPLICATION INFORMATION

Table 1. Recommended Configuration

V <sub>IN</sub> RANGE	C <sub>IN</sub>	LED STRING VOLTAGE (LEDA)	LED STRING CURRENT (LEDA)	R <sub>T</sub> OPTIMAL	f <sub>OPTIMAL</sub>	R <sub>T</sub> MIN	f <sub>MAX</sub>	RADJ	BIAS CONNECTION
4.5-36V	1μF 0805 50V	2.5-4V	35mA	open	0.50M	open	0.50M	154	2.8V to 25V source
6.5-36V	1μF 0805 50V	4-6V	35mA	open	0.50M	open	0.50M	154	LPWR
9.5-36V	1μF 0805 50V	6-9V	35mA	open	0.50M	open	0.50M	154	LPWR
12.5-36V	1μF 0805 50V	8-12V	35mA	open	0.50M	open	0.50M	154	LPWR
4.5-36V	1μF 0805 50V	2.5-4V	100mA	open	0.50M	open	0.50M	453	2.8V to 25V source
6.5-36V	1μF 0805 50V	4-6V	100mA	open	0.50M	165k	0.70M	453	LPWR
9.5-36V	1μF 0805 50V	6-9V	100mA	487k	0.57M	137k	0.75M	453	LPWR
12.5-36V	1μF 0805 50V	8-12V	100mA	487k	0.57M	88.7k	0.85M	453	LPWR
4.8-36V	1μF 0805 50V	2.5-4V	350mA	open	0.50M	open	0.50M	2.87k	2.8V to 25V source
7-36V	1μF 0805 50V	4-6V	350mA	open	0.50M	165k	0.70M	2.87k	LPWR
10.5-36V	1μF 0805 50V	6-9V	350mA	137k	0.75M	54.9k	1.0M	2.87k	LPWR
13.8-36V	1μF 0805 50V	8-12V	350mA	75k	0.90M	29.4k	1.37M	2.87k	LPWR
4.8-36V	1μF 0805 50V	2.5-4V	500mA	open	0.50M	open	0.50M	5.11k	2.8V to 25V source
7-36V	1μF 0805 50V	4-6V	500mA	open	0.50M	165k	0.70M	5.11k	LPWR
10.5-36V	1μF 0805 50V	6-9V	500mA	137k	0.75M	54.9k	1.0M	5.11k	LPWR
14.3-36V	1μF 0805 50V	8-12V	500mA	75k	0.90M	29.4k	1.37M	5.11k	LPWR
5-36V	1μF 0805 50V	2.5-4V	700mA	open	0.50M	open	0.50M	11.8k	2.8V to 25V source
7.7-36V	1μF 0805 50V	4-6V	700mA	487k	0.57M	165k	0.70M	11.8k	LPWR
11-36V	1μF 0805 50V	6-9V	700mA	165k	0.70M	54.9k	1.0M	11.8k	LPWR
14.8-36V	1μF 0805 50V	8-12V	700mA	75k	0.90M	29.4k	1.37M	11.8k	LPWR
5.5-36V	1μF 0805 50V	2.5-4V	1A	open	0.50M	open	0.50M	open	2.8V to 25V source
8-36V	1μF 0805 50V	4-6V	1A	open	0.50M	137k	0.75M	open	LPWR
11.5-36V	1μF 0805 50V	6-9V	1A	215k	0.65M	54.9k	1.0M	open	LPWR
15.5-36V	1μF 0805 50V	8-12V	1A	137k	0.75M	29.4k	1.37M	open	LPWR

## TYPICAL APPLICATIONS

### Step Down 1A Drive with Single Red or White LED

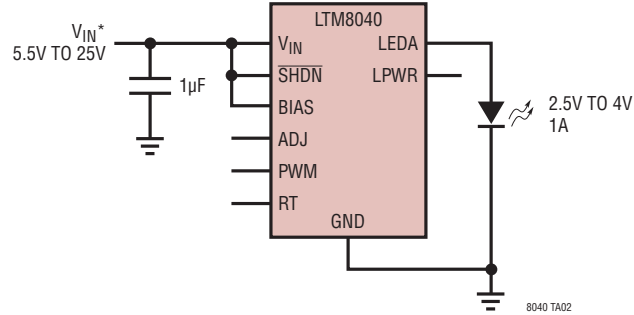

\*RUNNING VOLTAGE. SEE APPLICATION INFORMATION FOR START-UP REQUIREMENTS

### Step Down 350mA Drive with Three Series Red LEDs

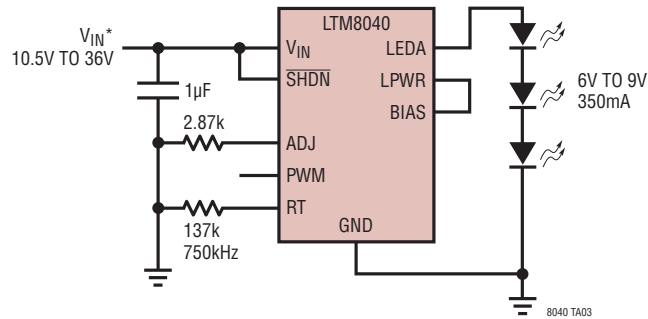

\*RUNNING VOLTAGE. SEE APPLICATION INFORMATION FOR START-UP REQUIREMENTS

### Step Down 1A Drive with Three White Series LEDs

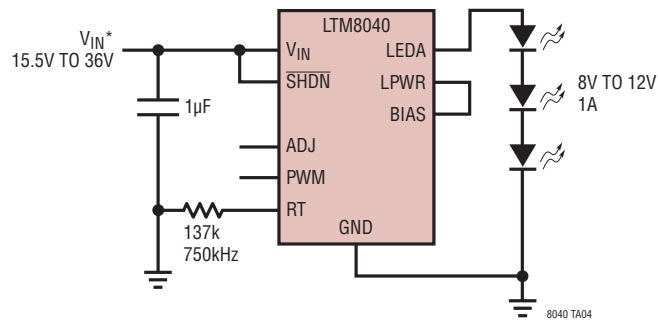

\*RUNNING VOLTAGE. SEE APPLICATION INFORMATION FOR START-UP REQUIREMENTS

# PACKAGE DESCRIPTION

**LGA Package**  
**66-Lead (15mm × 9mm × 2.82mm)**  
 (Reference LTC DWG # 05-08-1810 Rev 0)

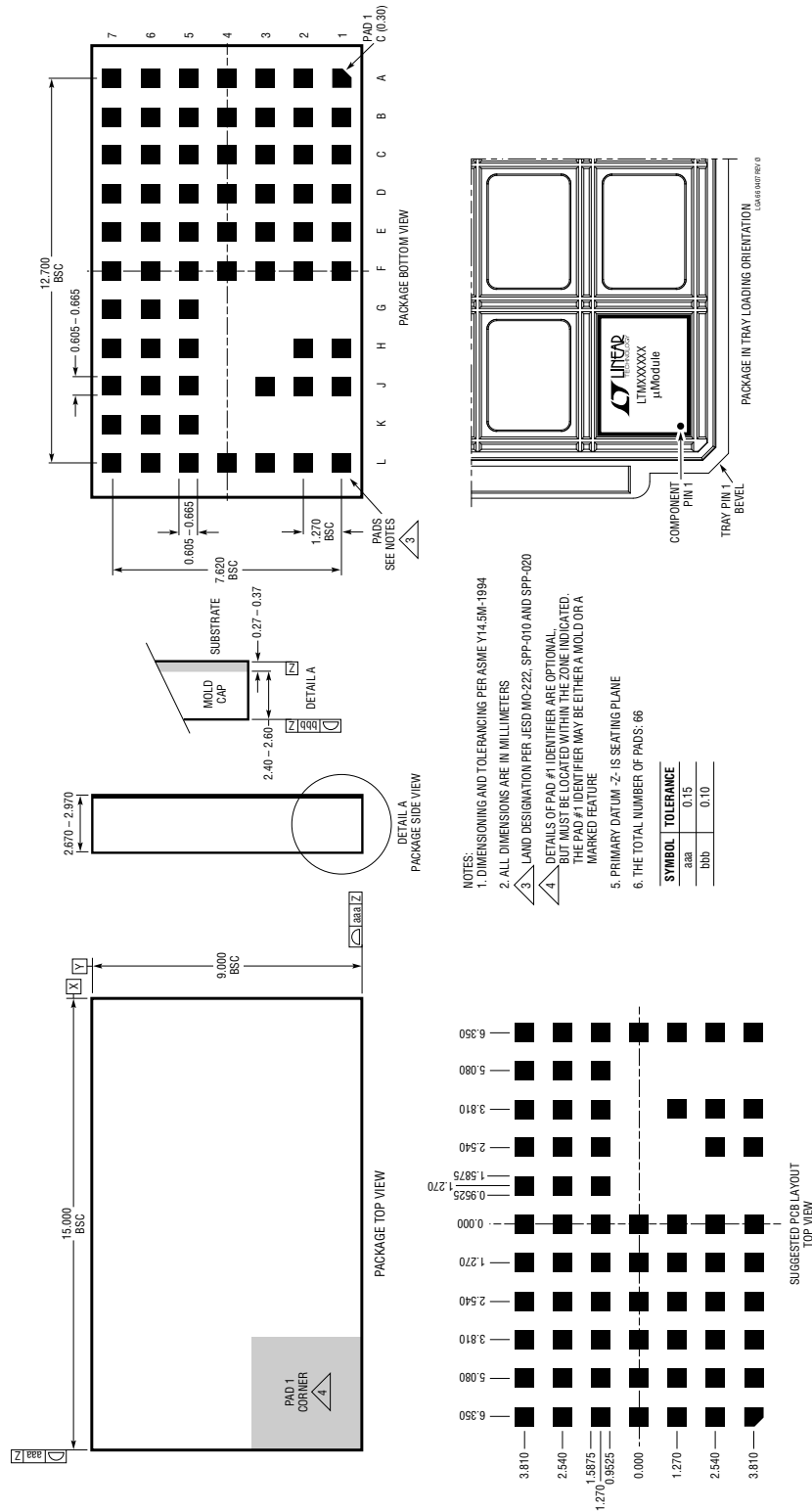

- NOTES:**
1. DIMENSIONING AND TOLERANCING PER ASME Y14.5M-1994
  2. ALL DIMENSIONS ARE IN MILLIMETERS
  3. LAND DESIGNATION PER JEDEC MO-222, SPP-910 AND SPP-020
  4. DETAILS OF PAD #1 IDENTIFIER ARE OPTIONAL BUT MUST BE LOCATED WITHIN THE ZONE INDICATED. THE PAD #1 IDENTIFIER MAY BE EITHER A MOLD OR A MARKED FEATURE
  5. PRIMARY DATUM - Z - IS SEATING PLANE
  6. THE TOTAL NUMBER OF PADS: 66

SYMBOL	TOLERANCE
aaa	0.15
bbb	0.10

## TYPICAL APPLICATION

### Step Down 1A Drive with Four Series Red LEDs

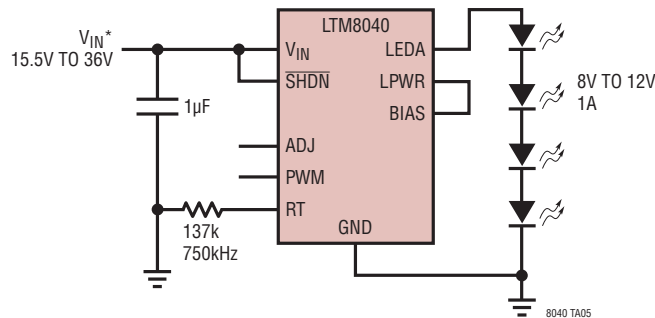

\*RUNNING VOLTAGE. SEE APPLICATION INFORMATION FOR START-UP REQUIREMENTS

## RELATED PARTS

PART NUMBER	DESCRIPTION	COMMENTS
LTM4600	10A DC/DC $\mu$ Module	Basic 10A DC/DC $\mu$ Module, 15mm $\times$ 15mm $\times$ 2.8mm LGA
LTM4600HVMPV	Military Plastic 10A DC/DC $\mu$ Module	-55°C to 125°C Operation, 15mm $\times$ 15mm $\times$ 2.8mm LGA
LTM4601/ LTM4601A	12A DC/DC $\mu$ Module with PLL, Output Tracking/Margining and Remote Sensing	Synchronizable, PolyPhase <sup>®</sup> Operation, LTM4601-1 Version Has No Remote Sensing
LTM4602	6A DC/DC $\mu$ Module	Pin-Compatible with the LTM4600
LTM4603	6A DC/DC $\mu$ Module with PLL and Output Tracking/Margining and Remote Sensing	Synchronizable, PolyPhase Operation, LTM4603-1 Version Has No Remote Sensing, Pin-Compatible with the LTM4601
LTM4604	4A Low $V_{IN}$ DC/DC $\mu$ Module	$2.375V \leq V_{IN} \leq 5V$ , $0.8V \leq V_{OUT} \leq 5V$ , 9mm $\times$ 15mm $\times$ 2.3mm LGA
LTM4605	5A to 12A Buck-Boost $\mu$ Module	High Efficiency, Adjustable Frequency, $4.5V \leq V_{IN} \leq 20V$ , $0.8V \leq V_{OUT} \leq 16V$ , 15mm $\times$ 15mm $\times$ 2.8mm
LTM4607	5A to 12A Buck-Boost $\mu$ Module	High Efficiency, Adjustable Frequency, $4.5V \leq V_{IN} \leq 36V$ , $0.8V \leq V_{OUT} \leq 25V$ , 15mm $\times$ 15mm $\times$ 2.8mm
LTM4608	8A Low $V_{IN}$ DC/DC $\mu$ Module	$2.375V \leq V_{IN} \leq 5V$ , $0.8V \leq V_{OUT} \leq 5V$ , 9mm $\times$ 15mm $\times$ 2.8mm LGA
LTM8020	36V, 200mA DC/DC $\mu$ Module	$4V \leq V_{IN} \leq 36V$ , $1.25V \leq V_{OUT} \leq 5V$ , 6.25mm $\times$ 6.25mm $\times$ 2.3mm LGA
LTM8022	1A, 36V DC/DC $\mu$ Module	Adjustable Frequency, $0.8V \leq V_{OUT} \leq 5V$ , 11.25mm $\times$ 9mm $\times$ 2.82mm, Pin-Compatible to the LTM8023
LTM8023	2A, 36V DC/DC $\mu$ Module	Adjustable Frequency, $0.8V \leq V_{OUT} \leq 5V$ , 11.25mm $\times$ 9mm $\times$ 2.82mm, Pin-Compatible to the LTM8022

PolyPhase is a trademark of Linear Technology Corporation

