

Thermal Design Using LUXEON® Power Light Sources

Introduction

LUXEON® Power Light Sources provide the highest light output with the smallest footprint of any Light Emitting Diodes (LEDs) in the world. This is due, in part, to LUXEON's ground breaking thermal design. LUXEON is the first LED solution to separate thermal and electrical paths, drawing more heat away from the emitter core and significantly reducing thermal resistance. As a result, LUXEON packages handle significantly more power than competing LEDs. LUXEON's larger, brighter emitters together with its unique high-power capabilities provide a tremendous amount of light in a small, durable package. This, in turn, provides lighting designers with a unique opportunity to explore new designs and product ideas and to improve the quality, energy-efficiency, safety and longevity of existing products.

Lighting designers working with LUXEON Power Light Sources do need to consider some potentially unfamiliar factors, such as the impact of temperature rise on optical performance. Proper thermal design is imperative to keep the LED emitter package below its rated operating temperature. This application note will assist design engineers with thermal management strategies.

We recommend taking the time to develop a thermal model for your application before finalizing your design. The LUXEON Custom Design Guide provides important details about operating temperatures for each LED emitter package. Once you determine your target temperature, a thermal model will allow you to consider the impact of factors such as size, type of heat sink, and airflow requirements.

Lighting designers needing additional development support for thermal management issues will find ample resources. The thermal management industry has grown along side advances in electronics design. The thermal analysis resources section at the end of this document provides a useful introduction to some industry resources.

Index

- Introduction1
- Minimum Heat Sink Requirements ..2
- Thermal Modeling2
- Inputs/Output of the Thermal Model 4
- Heat Sink Characterization4
- Attachment to Heat Sinks7
- Best Practices for Thermal Design ..8
- Evaluating Your Design8
- Validation of Method11

Minimum Heat Sink Requirements

All LUXEON products mounted on an aluminum, metal-core printed circuit board (MCPCB, also called Level 2 products) can be lit out of the box, though we do not recommend lighting the Flood for more than a few seconds without an additional heat sink.

As a rule, product applications using LUXEON Power Light Sources require mounting to a heat sink for proper thermal management in all operating conditions. Depending on the application, this heat sink can be as simple as a flat, aluminum plate.

The LUXEON Star, Line and Ring products consist of LEDs mounted on MCPCB in various configurations (see the *LUXEON Product Guide*). These products have 1 in² of MCPCB per emitter. The MCPCB acts as an electrical interconnect, as well as a thermal heat sink interface. While we recommend using an additional heat sink, these products can be operated at 25°C without one. The MCPCB can get very hot (~70°C) without a heat sink. Use appropriate precautions.

A LUXEON Flood should be mounted to a heat sink before being illuminated for more than a few seconds. A flat aluminum plate with an area of about 36 in² (6" x 6" x 0.0625" thick) is adequate when operating at 25°C.

Thermal Modeling

The purpose of thermal modeling is to predict the junction temperature (T_{Junction}). The word "junction" refers to the p-n junction within the semiconductor die. This is the region of the chip where the photons are created and emitted. You can find the maximum recommended value for each LUXEON product in your data sheet. This section describes how to determine the junction temperature for a given application using a thermal model.

A. Thermal Resistance Model

One of the primary mathematical tools used in thermal management design is thermal resistance (R θ). Thermal resistance is defined as the ratio of temperature difference to the corresponding power dissipation. The overall R $\theta_{\text{Junction-Ambient (J-A)}}$ of a LUXEON Power Light Source plus a heat sink is defined in Equation 1:

Equation 1. Definition of Thermal Resistance

$$R\theta_{\text{Junction-Ambient}} = \frac{\Delta T_{\text{Junction - Ambient}}}{P_d}$$

Where:

$\Delta T = T_{\text{Junction}} - T_{\text{Ambient}}$ (°C)

$P_d =$ Power dissipated (W)

$P_d =$ Forward current (If) * Forward voltage (Vf)

Heat generated at the junction travels from the die along the following simplified thermal path: junction-to-slug, slug-to-board, and board-to-ambient air.

For systems involving conduction between multiple surfaces and materials, a simplified model of the thermal path is a series-thermal resistance circuit, as shown in Figure 1A. The overall thermal resistance (R $\theta_{\text{J-A}}$) of an application can be expressed as the sum of the individual resistances of the thermal path from junction to ambient (Equation 2). The corresponding components of each resistance in the heat path are shown in Figure 1B. The physical components of each resistance lie between the respective temperature nodes.

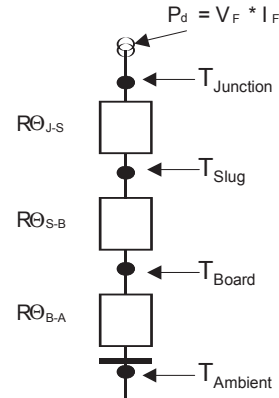

Figure 1A. Series Resistance Thermal Count

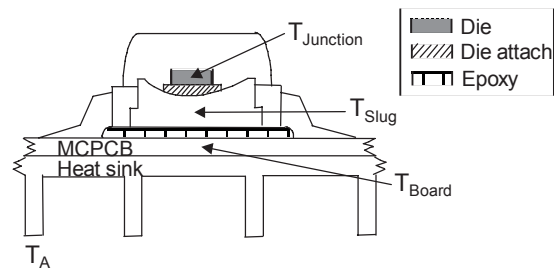

Figure 1B. Emitter Cut-Away

Equation 2. Thermal Resistance Model

$$R\theta_{\text{Junction-Ambient}} = R\theta_{\text{Junction-Slug}} + R\theta_{\text{Slug-Board}} + R\theta_{\text{Board-Ambient}}$$

Where:

R $\theta_{\text{Junction-Slug (J-S)}}$ = R θ of the die attach combined with die and slug material in contact with the die attach.

R $\theta_{\text{Slug-Board (S-B)}}$ = R θ of the epoxy combined with slug and board materials in contact with the epoxy.

R $\theta_{\text{Board-Ambient (B-A)}}$ = the combined R θ of the surface contact or adhesive between the heat sink and the board and the heat sink into ambient air.

Equation 3, derived from Equation 1 can be used to calculate the junction temperature of the LUXEON device.

Equation 3. Junction Temperature Calculation

$$T_{\text{Junction}} = T_A + (P_d)(R\theta_{\text{J-A}})$$

Where:

- T_A = Ambient temperature
- P_d = Power Dissipated (W) = Forward current (I_f) * Forward voltage (V_f)
- $R\theta_{\text{J-A}}$ = Thermal resistance junction to ambient

B. Thermal Resistance of LUXEON Light Sources

In LUXEON Power Light Sources, Philips Lumileds has optimized the junction-to-board thermal path to minimize the thermal resistance. The thermal resistance of a LUXEON emitter (not mounted on an MCPCB, also called a Level 1) is represented by $R\theta_{\text{J-S}}$.

The thermal resistance of LUXEON Power Light Sources (MCPCB mounted, also called a Level 2) representing by $R\theta_{\text{J-B}}$, equal to:

$$R\theta_{\text{J-B}} = R\theta_{\text{J-S}} + R\theta_{\text{S-B}}$$

Typical values for $R\theta$ are shown in Table 2.

Table 2 Typical LUXEON Thermal Resistance

Enter Description	LUXEON Power Light Sources ($R\theta_{\text{J-B}}$) MCPCB Mounted Level 2	LUXEON Emitter ($R\theta_{\text{J-B}}$) MCPCB Mounted Level 1
	Batwing (all colors) Lambertian (Green, Cyan, Blue, Royal Blue)	17°C/W
Lambertian (Red, Red-orange, Amber)	20°C/W	18°C/W

°C/W = °Celsius (ΔT) / Watts (P_d)

Note: Consult current data sheet for $R\theta_{\text{J-S}}$ and $R\theta_{\text{J-B}}$

C. Thermal Resistance of Multiple LUXEON Products

The total system thermal resistance of multiple-emitter LUXEON Products such as the LUXEON Line, Ring or multiple Stars can be determined using the parallel thermal resistance model as shown in Figure 2. In this model, each emitter is represented by individual, parallel thermal resistances.

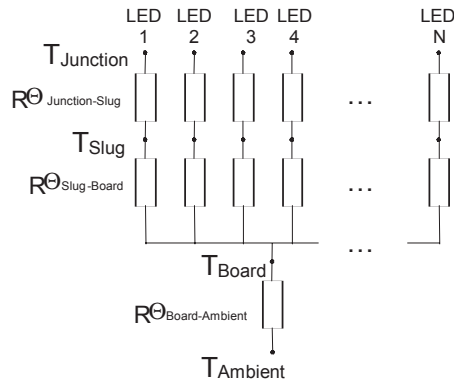

Figure 2. Parallel Thermal Resistance Model of Multiple Emitter Products

The $R\theta_{\text{J-B}}$ of the multiple-emitter array is obtained by using the parallel resistance equation:

$$\frac{1}{\text{Total_Array_}R\theta_{\text{Junction-Board}}} = \frac{1}{\text{LED}(1)_R\theta_{\text{Junction-Board}}} + \dots + \frac{1}{\text{LED}(N)_R\theta_{\text{Junction-Board}}}$$

All the parallel resistances can be assumed equivalent, so the equation becomes:

$$\frac{1}{\text{Total_Array_}R\theta_{\text{Junction-Board}}} = \frac{N}{\text{LED_Emitter_}R\theta_{\text{Junction-Board}}}$$

or:

Equation 4. Multiple Emitter to Single Emitter Thermal Resistance Relation

$$\text{Total_Array_}R\theta_{\text{Junction-Board}} = \frac{\text{LED_Emitter_}R\theta_{\text{Junction-Board}}}{N}$$

Where:

- LED Emitter $R\theta_{\text{Junction-Board}} = R\theta_{\text{Junction-Slug}} + R\theta_{\text{Slug-Board}}$
- N = Number of emitters

For example, in a LUXEON Line, there are 12 emitters, $N=12$. The LUXEON Line uses a batwing emitter; therefore, the Total Array $R\theta_{\text{J-B}}$ is: $(17^\circ\text{C/W})/12 = 1.42^\circ\text{C/W}$.

The Total Array $R\theta_{\text{Junction-Ambient}(J-A)}$ for the LUXEON Line is:

$$\text{Total_Array_}R\theta_{\text{Junction-Ambient}} = 1.42 + R\theta_{\text{Board-Ambient}}$$

The Total Array Dissipated Power must be used in any calculations when using a Total Array thermal resistance model. The Total Array Dissipated Power is the sum of $V_F * I_F$ for all the emitters.

Equation 5. Thermal Resistance of a Multiple Emitter Array

$$\text{Total Array } R\theta_{\text{J-A}} = \frac{\Delta T}{P_{d_Total}}$$

Where:

- ΔT = $T_{\text{Junction}} - T_{\text{Ambient}}$ (°C)
- P_{d_Total} = Total Array Dissipated Power (W)

Inputs/Output of the Thermal Model

You can use a thermal model to predict the junction temperature (T_J) for your application. This section discusses setting a goal for a maximum T_J as well as the variables in the right-hand-side of Equation 3 below. You can use variables in the thermal model as control factors in your application design.

$$T_{\text{Junction}} = T_{\text{Ambient}} + (P_d)/(R\theta_{\text{Junction-Ambient}})$$

A. Set Limit for Junction Temperature (T_J)

Good thermal design incorporates T_J limits based on three factors:

1. Light output with T_J rise
2. Color shift with T_J rise
3. Reliability

Consult *LUXEON Custom Design Guide* for more detailed information on light output and color shift with rise in T_J .

1. Light Output with Temperature Rise

LEDs experience a reversible loss of light output as the T_J increases. The lower the T_J is kept, the better the luminous efficiency of the product (i.e. the better the light output). Light output from red, red-orange and amber emitters (based on AlInGaP LED technology) are more sensitive to increases in junction temperature than other colors.

An example of light output loss associated with temperature rise occurs with traffic signals. Signals that are simply retro-fitted with LED sources may not account adequately for heat dissipation. As temperatures rise during the day, the signals may dim. Redesigning the signal housing to provide airflow to cool the components alleviates this condition.

The chart on the LUXEON product data sheet will help you determine a maximum T_J based on the light output requirements of your application.

2. Color Shift with Temperature Rise

Emitter color can shift slightly to higher wavelengths with T_J rise. Shift values quantifying this effect are included in the *LUXEON Custom Design Guide*. Red, Red-Orange and Amber color emitters are the most sensitive to this effect, although the human eye is more sensitive to color changes in the amber region. The importance of this effect depends on the color range requirements for the application. If the allowed color range is very small, you will need to account for color shift when setting your maximum T_J goal.

3. Reliability-Based Temperature Ratings

To ensure the reliable operation of LUXEON Power Light Sources, observe the absolute maximum thermal ratings for the LEDs provided in Table 1. The maximum T_J is based on the allowable thermal stress of the silicone encapsulate that surrounds die.

Table 1. Maximum Thermal Ratings.

Parameter	Maximum
LED Junction Temperature	120
Aluminum-Core PCB Temperature	105
Storage/Operating Temperature:	
LUXEON Products without optics (Star, Star/C)	-40 to 105
LUXEON Products with optics (Star/O, Line, Ring)	-40 to 75

B. Assess Ambient Temperature Conditions

The designer must take into account the maximum ambient temperature (T_A) the LUXEON Power Light Source will experience over its lifetime. In most cases, you can use product standards to determine the worst case T_A . Otherwise, use representative maximum T_A measurements. Please note that the ambient temperatures should include other sources of heat such as electronics or heating due to sun exposure.

C. Power Dissipated

The dissipated power (P_d) can be determined as the forward voltage (V_f) of the emitter times the forward current (I_f). The portion of power emitted as visible light (about 10%) is negligible for thermal design.

D. Add Heat Sink to Model

The $R\theta_{B-A}$ component of $R\theta_{J-A}$ (see Figure 1A) represents the heat sink and attachment interface. The responsibility for the proper selection of the heat sink thermal resistance, $R\theta_{B-A}$, lies with the engineer using the product. A process for selecting $R\theta_{B-A}$ is explained in the examples that follow. Many resources exist to assist with this selection. Some are listed in the resources section at end of this document. The following section provides additional guidance to help you determine the most suitable heat sink for your application.

Heat Sink Characterization

A. Explanation of Data Charts

1. Test Set Up

We tested some typical heat sink configurations on LUXEON Stars and Floods including both finned and flat heat sinks. We used the following test conditions: free (or natural) convection environment with no fan (Figures 3A, 3B, 3C and 3D) and forced convection in a small wind tunnel (Figure 3E). The LUXEON Stars tested did not have optics. The optics do not affect the $R\theta_{J-B}$ of the LUXEON emitter; however, depending on the orientation, they may affect the convection flow over the attached heat sink.

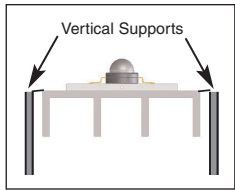

Figure 3.A. Finned Horiz.

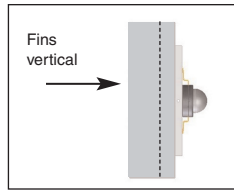

Figure 3.B. Finned Vert.

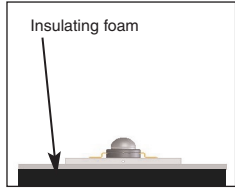

Figure 3.C. Flat Horiz.

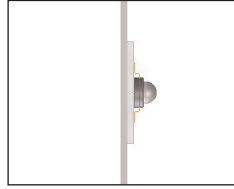

Figure 3.D. Flat Vert.

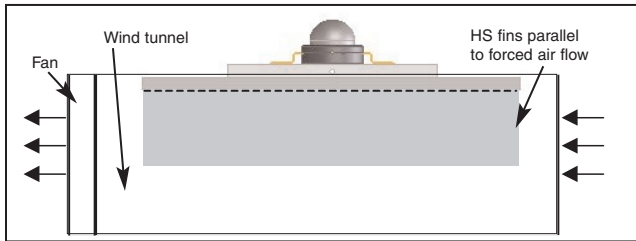

Figure 3.E. Finned Horiz. in Wind Tunnel

We tested two types of heat sinks: finned heat sinks and flat plates. All heat sinks were aluminum, which is typically the best choice because of its excellent thermal conductivity and ready, low-cost availability. We tested several different sizes of flat heat sinks and two sizes of finned heat sinks.

We tested some samples in free convection oriented both horizontally and vertically, as illustrated in Figures 3B, 3C and 3D.

Finned heat sinks were tested in a small wind tunnel enclosed in a control volume. Figure 3E shows the forced air set-up. We used the same set-up to characterize the finned heat sinks in free convection by turning the fan off (Figure 3A).

We suspended the finned heat sink so that air could circulate underneath it.

We used mechanical fasteners to mount the LUXEON Stars. The mounting surface of the heat sink was smooth and lightly polished. We did not use thermal grease.

We ran all tests in a closed volume test box to control the free convection and to improve repeatability. We made all measurements at steady state conditions. Initial ambient conditions were nominally 25°C, but the ambient temperature increased as the LEDs reached steady-state temperatures.

2. Heat Sink Characterization Chart Format

The following charts (Figures 4 to 9) are intended to guide the design engineer in selecting the size and type of heat sink required for an application. The charts for 25 mm spaced emitters in Figures 4 to 8 show $R_{\Theta_{B-A}}$ on the y-axis vs. heat sink area required per emitter on the x-axis. The chart for densely spaced emitters in Figure 9 shows $R_{\Theta_{B-A}}$ vs. heat sink area required for the entire array. The heat sink type and test set-up (Figures 3A to 3E) is referenced in the title and discussion of each chart.

3. Definition of Heat Sink Size

The following charts quantify heat sink size in two ways. The term "exposed surface area" is the sum total of all surfaces of the heat sink exposed to convection. The "footprint area" quantifies the projected area of the heat sink as shown in following diagram.

A finned heat sink can fit more exposed surface area in a given foot print than a flat heat sink.

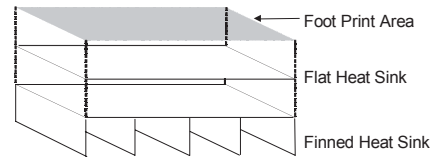

B. Heat Sink Characterization Charts - 25mm Emitter Spacing

When LUXEON emitters are spaced at least 25 mm apart, each acts as a discrete heat source. The charts in figures 4 to 8 will help you size heat sinks for the LUXEON Star, Line and Ring as well as custom boards with individual emitters spaced 25 mm or further apart. These charts should also be helpful in characterizing heat sinks for custom boards with emitter spacing as dense as 20 mm. For boards with more densely spaced emitters, use the chart in Section C. The following in Figures 4 to 8 show $R_{\Theta_{B-A}}$ vs. heat sink area required per emitter in your application.

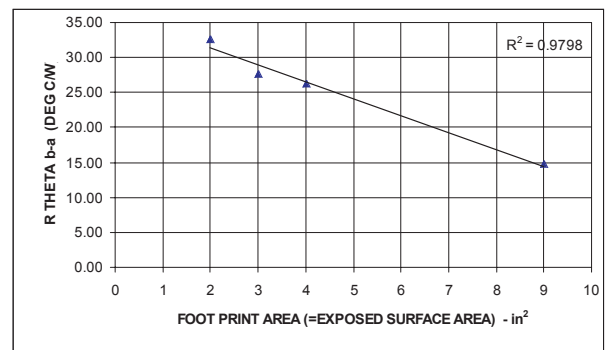

Flat Heat Sink, 0.09" (2.3 mm) Horizontal on insulating foam Set-up in Figure 3C. Solid Line: Linear Fit of Data

Figure 4. $R_{\Theta_{Board-Ambient}}$ per Emitter vs. Foot Print Area

2. Horizontal, Flat Heat Sink (Fig. 3C) in Free (Natural) Convection

As exposed surface area increases, thermal resistance decreases. Figure 4 illustrates this relationship with a flat, horizontal heat sink, which is close to linear.

In the horizontal orientation, only a single, upward-facing surface of the flat heat sink is exposed to convection. The bottom surface contacts the insulating foam. This is the least efficient orientation for convection, resulting in the highest expected thermal resistance.

3. Horizontal (Fig. 3C) vs. Vertical Orientation (Fig. 3D) in Free Convection

When the flat heat sink is oriented vertically, the surface area doubles, as both sides are exposed to free convection. This results in a more efficient heat sink within the same foot print area. This effect is illustrated with respect to the foot print area in Figure 5.

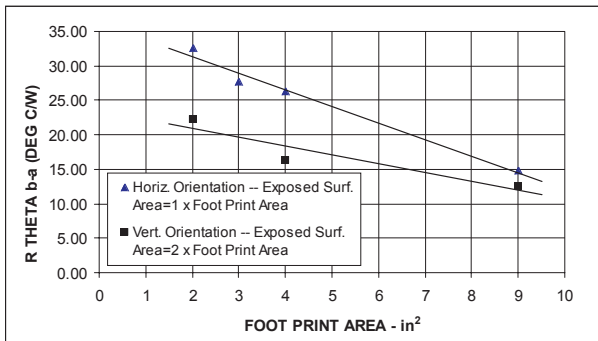

Flat Heat Sink 0.09" (2.3 mm) Thick - Horiz. Set-up Fig. 3C - Vert. Set-up Fig 3D

Figure 5. $R\Theta_{Board-Ambient}$ Per Emitter in Free Convection Vs. Foot Print Area.

In the vertical orientation, the thermal resistance decreases noticeably as the exposed surface area doubles. The total surface area of the horizontal heat sink equals the foot print area. For the vertical heat sink, the total surface area is double the foot print area.

The vertical heat sink is also more efficient due to the nature of free convection. Buoyant, warm air moving over a vertical surface is more efficient than air that moves vertically away from a horizontal surface.

As the foot print areas approach 9in², the $R\Theta_{B-A}$ of the two orientations begin to converge. This indicates that as foot print areas approach 9in² per emitter, heat sink orientation is not influential. Also, with areas greater than 9in² per emitter, there are diminishing reductions in the $R\Theta_{B-A}$. The lower limit for $R\Theta_{B-A}$ with increasing area will approach about 10 to 11 °C/W.

4. Range of Efficiency with Flat Heat Sinks

The two conditions shown in Figure 5 represent the most efficient (vertical, 2 convective surfaces) and least efficient

(horizontal on low-conducting insulating foam) configurations of a flat heat sink. Most applications probably fall some where in between.

When selecting a heat sink for your application, you will need to determine the most comparable condition. You will also need to assess other factors that might make the $R\Theta_{B-A}$ of the larger or smaller than the extremes shown in Figure 5. Mounting the heat sink to a conductive surface or at a 45° angle, for example, are both factors that would reduce the $R\Theta_{B-A}$ compared to the horizontal orientation in Figure 5.

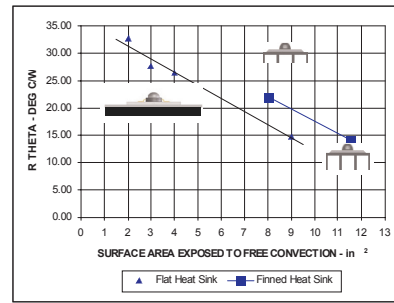

Figure 6.

$R\Theta_{Board-Ambient}$ per Emitter in Free Conv.

Horizontal Flat Heat Sink - Set-up Fig. 3A vs. Horizontal Finned Heat Sink - Set-up Fig. 3C

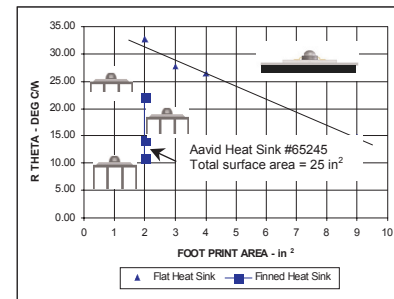

Figure 7.

5. Finned (Fig. 3A) vs. Flat Heat Sinks (Fig. 3C) in Free (Natural) Convection

We tested two finned heat sinks with identical 2 in² foot print areas, but different exposed surface areas. Increasing the number and length of fins on the heat sink increases the surface area. The fin spacing was about 0.25 in. Figure 6 shows $R\Theta_{B-A}$ per exposed surface area for finned heat sinks and flat heat sinks. The heat sinks plotted in Figure 6 are horizontal (Set-up Figure 3A for finned, Figure 3C for flat).

The finned heat sinks required more exposed surface area for a given $R\Theta_{B-A}$ compared to the flat heat sinks. This shows that a flat heat sink can be effective in thermally managing LUXEON Power Light Sources with 25 mm emitter spacing.

In order to fully utilize the surface area on the finned heat sinks, the fins must lie in parallel with the convection airflow. The finned heat sinks would probably have a slightly lower $R\Theta_{B-A}$ if oriented vertically (Set-up Figure 3B).

6. Finned Heat Sinks Reduce Foot Print Size

The Figure 7 shows $R\Theta_{B-A}$ per foot print area for finned heat sinks and flat heat sinks. Each of the finned heat sinks had 2 in² footprints. The flat heat sinks have footprints equal to the exposed area. A flat heat sink needs about 6 in² footprint to match the $R\Theta_{B-A}$ of a 2 in² foot print finned heat sink. If foot print size is a major design constraint, a finned heat sink offers an efficient solution.

The lower limit for $R\Theta_{B-A}$ using a 2 in² footprint finned heat sink is about 10 to 11 °C/W. A heat sink typical of this performance is an AAVID heat sink extrusion part # 65245. A 1.6 in length of this heat sink extrusion has 25 in² total surface area with a 2 in² footprint. $R\Theta_{B-A}$ for this heat sink is plotted in Figure 7. Looking at Figure 5, a 9 in² vertical flat heat sink (18 in² total surface area) would have about the same $R\Theta_{B-A}$.

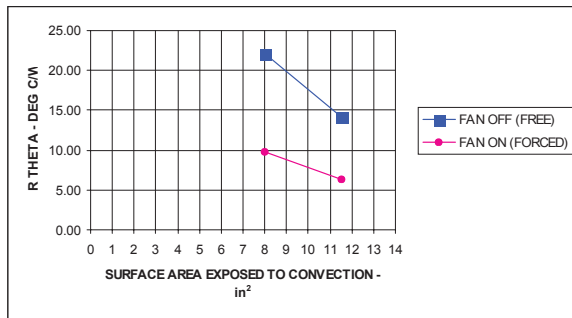

Figure 8. $R\Theta_{Board-Ambient}$ per Emitter - Free Conv. (Test Set-up Fig. 3A) vs. Forced Conv. (Test Set-up Fig. 3E) - 42f/min (12.8m/min) Air Flow with Fan On

B. Heat Sinks in Free Convection - Dense Emitter Spacing

When LUXEON emitters are densely packed, they function as a single heat source. This chart will help you characterize the LUXEON Flood as well as custom Level 2 Boards with emitter spacing between 9 and 13 mm. This chart can also be used to characterize heat sinks for clustered emitters, with spacing up to about 19 mm. For wider spacing, use the charts in Section B. The following chart in Figure 9 shows the Total Array $R\Theta_{B-A}$ vs. heat sink area required for the total array. It is the total array $R\Theta_{B-A}$ shown in Figure 2, which is the thermal resistance model for multiple emitter products.

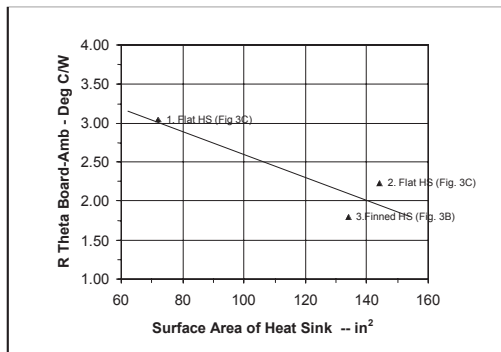

Figure 9. High Density Emitter Heat Sink Total Array Thermal Resistance (Board to Ambient) vs. Surface Area Exposed

We characterized three types of heat sinks using 12 and 18 emitter LUXEON Floods. The results are shown in Figure 9. All heat sinks were vertically orientated with free convection on all sides. We tested both flat plate (see Figure 3D test set-up) and finned heat sinks (see Figure 3B.)

Figure 9 should be most useful in sizing heat sinks for custom applications that use ten to twenty emitters. However, it can also be used as a rough guide for sizing heat sinks for applications with about 3 to 20 densely spaced emitters.

Attachment to Heat Sinks

A. Mechanical Attachment

We recommend mounting LUXEON Power Light Sources (Level 2 products) directly to a heat sink with mechanical fasteners for best performance. You can use fasteners when mounting to a smooth machined or extruded metal surface. The addition of thermal grease (e.g. Wakefield Eng. Thermal Compound) can minimize air gaps and improve thermal contact to castings and uneven surfaces.

B. Adhesive Attachment

Tapes and adhesives can aid in thermal contact with most surfaces. Philips Lumileds utilizes Amicon E 3503-1 as the epoxy for attaching LEDs onto boards. The thermal properties of Amicon and a double sided Bergquist tape are shown in Table 3.

Adhesives are available from many sources, such as, Epo-Tek, Dow Corning, 3M, and others, however, the customer must perform a thorough evaluation of the adhesive in terms of thermal performance, manufacturability, lumen maintenance, and mechanical durability.

Furthermore, Philips Lumileds does not recommend adhesives containing hydrocarbons such as amine, heptane, hexane, and other volatile organic compounds.

Table 3 Typical Thermal Resistances of Glues and Tapes.

		Level 1 Mounting - Emitter Slug to Board Added $R\Theta_{\text{slug-board}}$ ($^{\circ}\text{C}/\text{W}$) per Emitter 0.044 in ² (28 mm ²) Slug Area	Level 2 Mounting - Board to Heat Sink Added $R\Theta_{\text{Board-Heat_Sink_Top}}$ ($^{\circ}\text{C}/\text{W}$) per Emitter 1 in ² (625 mm ²) Board Area	Manufacturer Information
	Adhesives			
Glues approx. 0.05" thick	Amicon E3503-1	4.5	*	Emerson & Cuming-Belgium Ph: 0032/ 14 57 56 11
Tapes	Bond Ply 105 (0.005" thick)	14	3 $^{\circ}\text{C}/\text{W}$	The Bergquist Company www.bergquistcompany.com

Before selecting an adhesive or interface material be sure to determine its suitability and compatibility with LUXEON, your manufacturing processes, and your application. Philips Lumileds uses Amicon 3503-1 from Emerson and Cuming. This epoxy may be purchased from multiple distributors. Some examples of these distributors may be found in the Philips Lumileds Resource Guide at www.philipslumileds.com.

Best Practices for Thermal Design

- A flat, aluminum heat sink can be as effective as a finned heat sink when emitters are spaced at least 25 mm apart.
- A finned heat sink is an effective solution to minimize footprint area.
- For maximum thermal performance using a flat heat sink, allow an exposed surface area of about 9in² per emitter (with 25 mm emitter spacing).
- A LUXEON Flood requires a flat heat sink with an exposed surface area of 36in² to operate at room temperature (25 $^{\circ}\text{C}$).
- Where practical, use mechanical fasteners to mount heat sinks to smooth and flat surfaces.

Evaluating Your Design

Use the charts in Figures 4 to 9 to approximate the heat sink size, as well as its orientation and shape.

To do so, you must first determine the required $R\Theta_{\text{B-A}}$, per emitter, given both the thermal and optical requirements of your application. Then based on the required $R\Theta_{\text{B-A}}$, you can use the data in the charts to define your heat sink requirements. General steps for doing this follow.

For single or multi-emitter applications with 25mm spacing, you can approximate heat sink requirements using Figures 4 to 8. For applications with dense emitter spacing such as the LUXEON Flood, use Figure 9.

A. Steps to Select Minimum Size Heat Sink

Step 1) Determine allowable $R\Theta_{\text{J-A}}$

With T_{J} as the constraining variable, you can use the following equation:

$$T_{\text{J}} = T_{\text{A}} + (P)(R\Theta_{\text{J-A}})$$

Enter the absolute maximum T_{J} and the worst case operating conditions T_{A} into the equation. You may need to specify a maximum T_{J} lower than 120 $^{\circ}\text{C}$ in order to achieve the optical performance required for your application. See the *LUXEON Custom Design Guide* for more information.

The dissipated power per string, P, can be determined by:

$$P = (V_{\text{F}})(I_{\text{F}})$$

Solve for $R\Theta_{\text{J-A}}$ using:

$$R\Theta_{\text{Junction - Ambient}} = \frac{(T_{\text{Junction}} - T_{\text{Ambient}})}{P}$$

Step 2) Subtract the $R\Theta_{J-B}$ (found in Table 1, also check current product data sheet) of LUXEON emitter from $R\Theta_{J-A}$ to obtain the target $R\Theta_{B-A}$.

Step 3) Using the calculated $R\Theta_{B-A}$ as a target, review the charts in Figures 4 to 9 to determine the heat sink configuration that best suits your application. Look up the heat sink area that corresponds to the target $R\Theta_{B-A}$. The aim is to determine heat sink size range your application requires. You can reduce heat sink footprint area with a finned heat sink.

If you know the heat sink size constraints for your application, you can determine a target $R\Theta_{B-A}$ for the particular heat sink design first. As you evaluate your design, you can change input variables from Step 1 iteratively using the heat sink size as a constraint.

For example, an application may be able to run at a lower drive current, I_F , and still meet the light output requirements. This would reduce the dissipated power, P , resulting in a larger target $R\Theta_{B-A}$ which could be met with a smaller heat sink.

B. Utilizing Other Thermal Analysis Resources

In addition to the data in the results section, other resources are available to help determine an appropriate heat sink to meet your target $R\Theta_{B-Ak}$ including published heat sink characterization data references and thermal analysis software.

When using reference materials, realize the LUXEON emitters act as point sources of heat that are not evenly distributed over an entire mounting surface.

Aavid Thermalloy is a manufacturer of extruded heat sink products. They offer free selector tool software for choosing standard heat sink profiles size with a given $R\Theta$. That software tool, as well as links to other thermal analysis tools and software can be accessed from the following web link: <http://www.aavidthermalloy.com/>

R-theta is another manufacturer of heat sink products. They also offer analysis tools at their web link: <http://www.r-theta.com/>

Thermal resources and tools can be found at these sites:
<http://www.electronics-cooling.com>
<http://www.coolingzone.com>
<http://www.thermalwizard.com>

C. Check Your Design

When physical prototypes of the application are available, it is important to monitor the metal-core PCB temperature of the emitters and compare with the results from the thermal model.

Monitor temperatures at the hottest part of the board, typically near the center of the emitter array and as close as

possible to an emitter base (Figure 10). Evaluate the design at the expected ambient temperature range, ambient air flow and with any additional heat loads.

You can monitor temperatures using a surface probe temperature meter, though this is not practical for applications in enclosures. In general, thermocouples offer the most practical temperature monitoring solution.

Recommended thermocouple (TC) attachment:

1. Locate TCs on the hottest areas of the board. Examples are: near the center of a cluster array of emitters or near any heat producing electronics.
2. Locate the TCs as close as possible near the base of an emitter. Do not mount TC tip on lead traces. Do solder or mount TCs to the emitter solder pads.
3. If using small diameter TCs (J-type) or adhesive mounted TCs, they can be taped flat to the top of the board, with the TC tip at the base of the emitter.
4. If using a larger T or K-type TC, it may not be possible to tape the TC tip flat on the board, which would lead to inaccuracies. In this case, drill a hole, just larger than the TC dia. in the top of the board, 0.03" deep. (Figure 11) Bend the TC tip at right angle. For better contact, dip the TC tip in a conductive paste (e.g. Wakefield Eng, Thermal Compound). Insert the TC tip and secure the TC wire with tape or glue to keep the TC tip fully inserted.

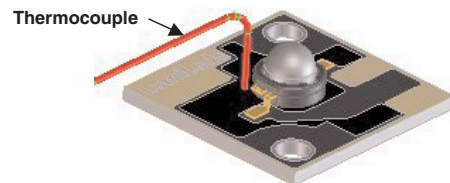

Figure 10. Location of thermocouple to Monitor T_{Board} .

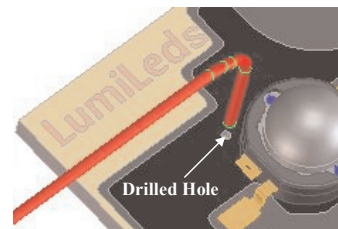

Figure 11. Thermocouple tip inserted in board.

D. Examples

Example 1: LUXEON Star-Single Emitter

A single-emitter LUXEON Star application requires a flat, aluminum heat sink using free convection: It will operate at a maximum ambient of 85°C. The application uses an amber batwing emitter driven at 335mA.

Step 1) Determine allowable $R\Theta_{\text{Junction-Ambient}}$.

Using the heat transfer formula:

$$T_{\text{Junction}} = T_{\text{Ambient}} + (P)(R\Theta_{\text{Junction-Ambient}})$$

or:

$$R\Theta_{\text{Junction-Ambient}} = \frac{(T_{\text{Junction}} - T_{\text{Ambient}})}{(P)}$$

Where:

$$\begin{aligned} T_J &= 120^\circ\text{C (max. junction temp.)} \\ T_A &= 85^\circ\text{C (max. based on operating conditions)} \\ \text{Maximum } V_f &= 3.3 \text{ V for amber batwing (consult data sheet)} \\ P_d &= (V_f)(I_f) \\ P_d &= 3.3 \text{ V} * 335\text{mA} = 1.1\text{W} \end{aligned}$$

Solving for $R\Theta_{\text{J-A}}$:

$$R_{\text{J-A}} = \frac{(120 - 85)}{1.1}$$

$$R\Theta_{\text{J-A}} = 32^\circ\text{C/W}$$

Step 2) Obtain the target $R\Theta_{\text{B-A}}$.

Subtract $R\Theta_{\text{J-B}}$ of the LUXEON emitter:

$$R\Theta_{\text{B-A}} = 32^\circ\text{C/W} - 17^\circ\text{C/W (for Batwing LED)}$$

$$R\Theta_{\text{B-A}} = 15^\circ\text{C/W}$$

Step 3) Review heat sink characterization data in results section.

Depending on the space requirements of the application, the thermal resistance target ($R\Theta_{\text{B-A}} = 15^\circ\text{C/W}$) could be met with several different heat sink designs. The area required for a flat, horizontal heat sink with only one free convection surface would be about 9in² (Figure 4).

The design could also be executed using a 4in² flat, vertical heat sink that has two free convection surfaces (Figure 5).

To reduce the foot print area to 2in², a finned heat sink may be used with a total surface area of about 11.5in² (Figure 8).

If the required drive current of the emitter was 350mA, then the target $R\Theta_{\text{B-A}}$ would have been slightly lower, necessitating a heat sink with a slightly larger area.

Example 2: LUXEON Line -12 Emitter

A LUXEON Line (12 emitters) will be mounted in a vertical position. The maximum ambient operating condition is 75°C for LUXEON products with optics. The emitters are red and driven at 325mA.

Step 1) Determine allowable $R\Theta_{\text{Board-Ambient}}$.

Using the heat transfer formula:

$$R\Theta_{\text{Junction-Ambient}} = \frac{(T_{\text{Junction}} - T_{\text{Ambient}})}{(P)}$$

Where:

$$\begin{aligned} T_J &= 120^\circ \text{ (max. junction temp.)} \\ T_A &= 75^\circ\text{C} \\ \text{Maximum } V_f &= 20 \text{ V/6 emitters in series (consult data sheet)} \\ \text{Maximum } V_f &= 3.3 \text{ V} \\ P_d &= 325\text{mA} * 3.3 \text{ V} = 1.1\text{W per emitter} \end{aligned}$$

Solving for $R\Theta_{\text{J-A}}$:

$$R_{\text{J-A}} = \frac{(120 - 75)}{1.1}$$

$$R_{\text{J-A}} = 41^\circ\text{C/W}$$

Step2) Obtain the target $R\Theta_{\text{B-A}}$.

Use Equation 4 to obtain the $R\Theta_{\text{J-B}}$ per emitter:

$$\text{Total_Array_}R\Theta_{\text{Junction-Board}} = \frac{\text{LED_Emitter_}R\Theta_{\text{Junction-Board}}}{N}$$

$$\begin{aligned} \text{Total } R\Theta_{\text{J-B}} &= 1.4^\circ\text{C/W for LUXEON Line (consult data sheet)} \\ R\Theta_{\text{J-B}} \text{ per emitter} &= 1.4^\circ\text{C/W} * 12 \\ R\Theta_{\text{J-B}} \text{ per emitter} &= 17^\circ\text{C/W} \\ R\Theta_{\text{B-A}} &= 41^\circ\text{C/W} - 17^\circ\text{C/W} \\ R\Theta_{\text{B-A}} &= 24^\circ\text{C/W per emitter} \end{aligned}$$

Step 3) Review heat sink characterization data in results section.

Reviewing Figure 5, the LUXEON Line would require 2in² foot print of flat heat sink per emitter with two vertically oriented, free convection surfaces. That would correspond to a total HS area of 48in² with a 24in² footprint.

The total system $R\Theta_{\text{J-A}}$ can be obtained by using a calculation similar to Equation 4, where "N" is the number of emitters.

$$\text{Total_System_}R\Theta_{\text{Junction-Ambient}} = \frac{\text{Emitter_}R\Theta_{\text{Junction-Ambient}}}{N}$$

$$\text{Total_System_R}_{J-A} = 3.4^{\circ}\text{C/W}$$

The T_J at a given T_A can be calculated using Equation 3. The total array power must be used when using the total system $R_{\Theta_{J-A}}$.

$$\text{Calculate } T_J \text{ at } T_A = 25^{\circ}\text{C}$$

$$\text{Total Array Power} = 12 \times 1.1 \text{ W} = 13.2 \text{ W}$$

Equation 3:

$$T_{\text{Junction}} = T_{\text{Ambient}} + (P)(R_{\Theta_{\text{Junction-Ambient}}})$$

$$T_J = 25^{\circ}\text{C} + (13.2 \text{ W})(3.4^{\circ}\text{C/W})$$

$$T_J = 70^{\circ}\text{C}$$

Validation of Method

To test the validity of this method, we instrumented and measured a LUXEON Line 12-emitter array with 48in² of flat heat sink. In a vertically oriented position, the measured $R_{\Theta_{B-A}} = 2.5^{\circ}\text{C/W}$.

By adding the Total Array $R_{\Theta_{J-B}}$ of 1.42^oC/W, the measured Total System $R_{\Theta_{J-A}}$ is 3.9^oC/W versus the predicted $R_{\Theta_{J-A}}$ of 3.4^oC/W.



Company Information

LUXEON®, SuperFlux and SnapLED are developed, manufactured and marketed by Philips Lumileds Lighting Company. Philips Lumileds is a world-class supplier of Light Emitting Diodes (LEDs) producing billions of LEDs annually. Philips Lumileds is a fully integrated supplier, producing core LED material in all three base colors (Red, Green, Blue) and White. Philips Lumileds has R&D centers in San Jose, California and in The Netherlands and production capabilities in San Jose and Penang, Malaysia. Founded in 1999, Philips Lumileds is the high-flux LED technology leader and is dedicated to bridging the gap between solid-state LED technology and the lighting world. Philips Lumileds technology, LEDs and systems are enabling new applications and markets in the lighting world.

Philips Lumileds may make process or materials changes affecting the performance or other characteristics of our products. These products supplied after such changes will continue to meet published specifications, but may not be identical to products supplied as samples or under prior orders.



WWW.LUXEON.COM
WWW.LUMILEDSFUTURE.COM

FOR TECHNICAL ASSISTANCE OR THE LOCATION OF YOUR NEAREST SALES OFFICE CONTACT ANY OF THE FOLLOWING:

NORTH AMERICA:
+1 888 589 3662 OR
ASKLUXEON@FUTUREELECTRONICS.COM

EUROPE:
OO 800 443 88 873 OR
LUXEON.EUROPE@FUTUREELECTRONICS.COM

ASIA:
800 5864 5337 OR
LUMILEDS.ASIA@FUTUREELECTRONICS.COM