

LED Animator

RGB Color Animation Single Color LED Controller	
Total Power	25 Watts max. / channel
Input Voltages	8 ~ 30VDC
Number of Outputs	Up to 8

Product Specifications

ANZ#: Z111a, October 12, 2005

Our LED Lighting Controllers Animation line of products includes simple 3, 4 or 8-circuit solid-state chaser/sequencers, available in different models for driving 12, 24VDC loads. These designs provide chasing, fading and flashing effects for conventional through hole LED (uses Constant Voltage Mode) or high brightness LED (uses Constant Current Mode)

Features

- Wide Input Voltage Range (8V ~ 30VDC)
- Radial switch with adjustable speed
- Up to 8 pre-selectable patterns
- Chasing, Cross-Fading or Flashing Effects
- High efficient, low power loss
- Compact size, approx. 5" x 2" x 1" (LxWxH)
- 3A max. per channel

Electrical Specifications

Input Voltage	8 ~ 30VDC
Output Freq.	1KHz
Output Current	1 Amp max. – Constant Current Mode 6 Amps max. – Constant Voltage Mode
Output Voltage	Vin – 5VDC
Output Channels	3, 4 or 8 channels
Temp. Range	-20 ~ +50 Deg. C

Wiring Diagram with Constant Voltage Mode

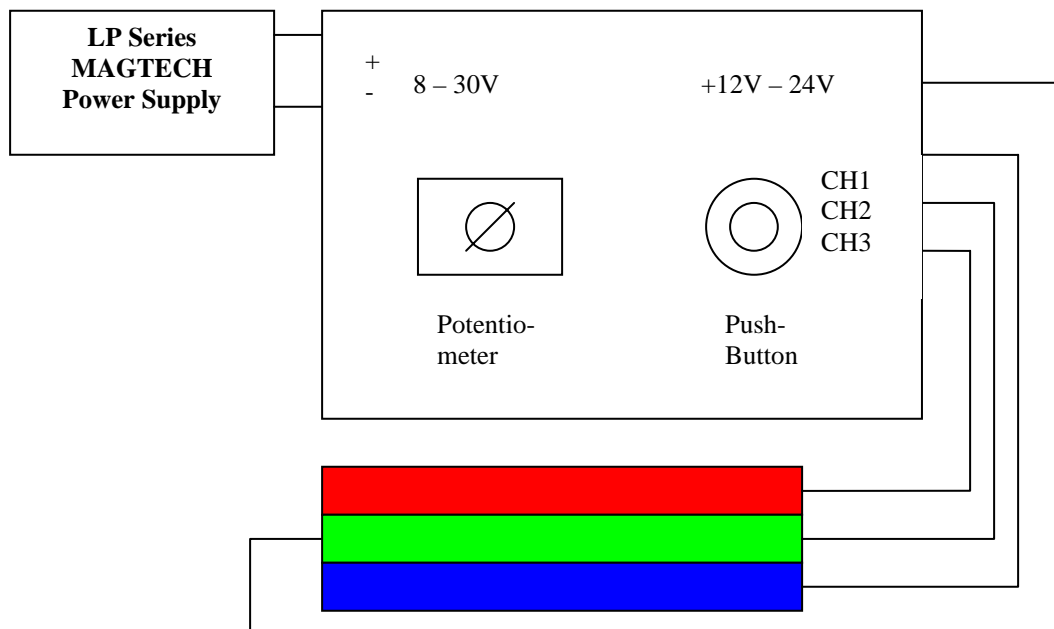

Wiring Diagram with Constant Current Mode

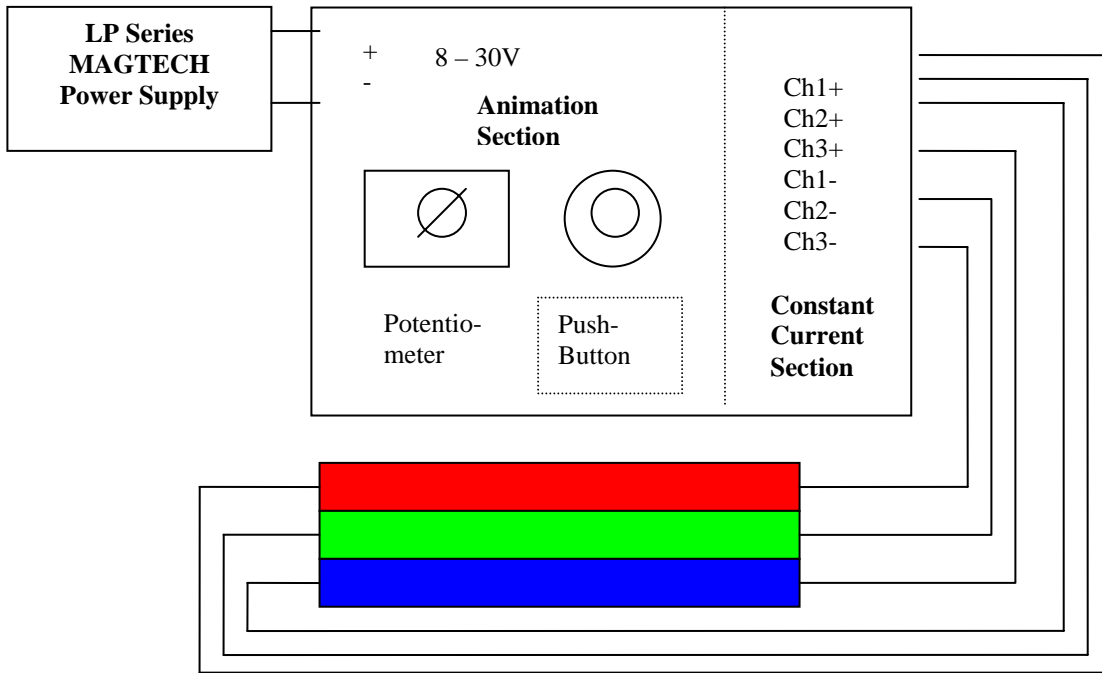

REVISIONS		
REV	DESCRIPTION	DATE
A	RELEASE TO PRODUCTION	

3 CHANNELS

Seq #1

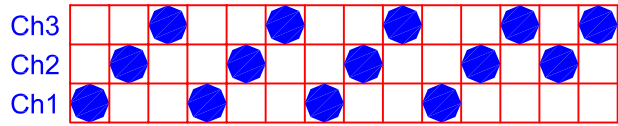

Seq #2

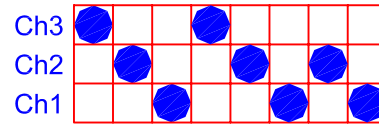

Seq #3

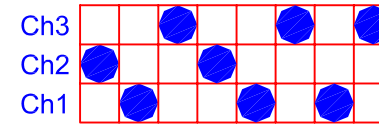

Seq #4

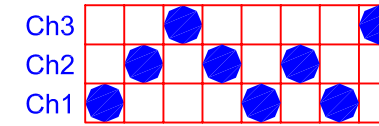

Seq #5

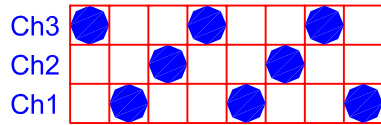

Seq #6

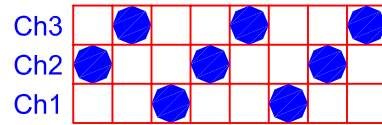

Seq #7

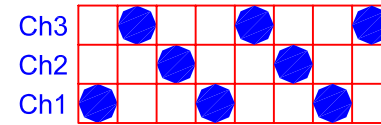

Fading

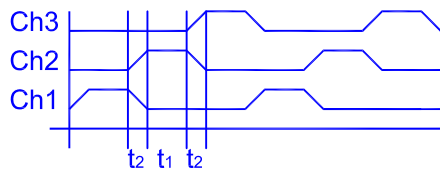

Standard timing:
 t_1 : 3~17 Sec, 6~35 Sec
 (pot selectable)
 t_2 : 5.5 Sec, 13.5 Sec

non-Fading

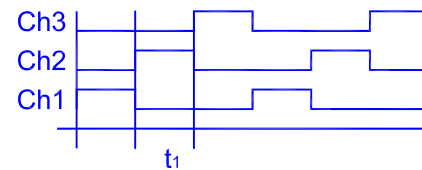

THIS ITEM IS THE PROPERTY OF PFC AND CONTAINS PROPRIETARY CONFIDENTIAL AND TRADE SECRET INFORMATION. THE INFORMATION CONTAINED HEREIN MUST NOT BE USED, DISCLOSED OR REPRODUCED IN WHOLE OR IN PART WITHOUT PRIOR WRITTEN CONSENT FROM PFC.

UNLESS OTHERWISE SPECIFIED		APPROVAL DATE		10/04/05		PFC Corporation	
DIMENSIONS ARE IN INCHES [MM]		CHECKED BY					
TOLERANCES: .X DECIMALS± .05 [1.3] .XX DECIMALS± .02 [0.5] .XXX DECIMALS± .005 [0.13]		APPROVED BY				MODEL NO. TBD	
ANGLES± 1° FRACTIONS± 1/16		DO NOT SCALE THIS DRAWING		INTERPRET DRAWING PER ANSI Y14.5M		DWG NO. 01-0101	
						REV. SHEET OF A 1 1	

REVISIONS		
REV	DESCRIPTION	DATE
A	RELEASE TO PRODUCTION	

8 CHANNELS

Seq #1

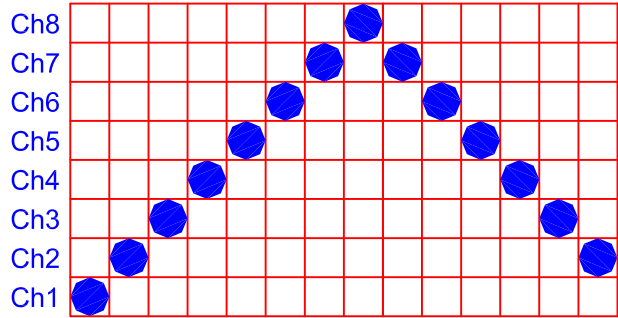

Seq #2

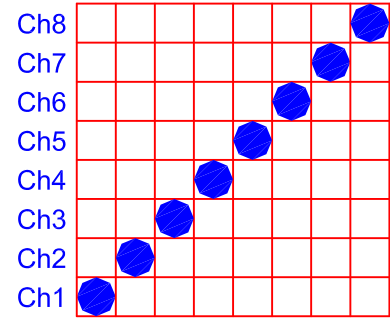

Seq #3

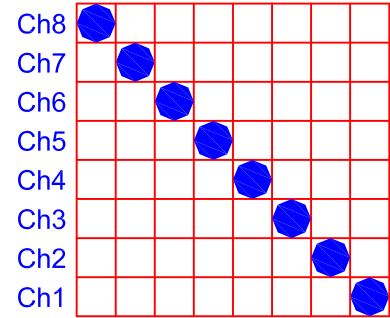

non-Fading

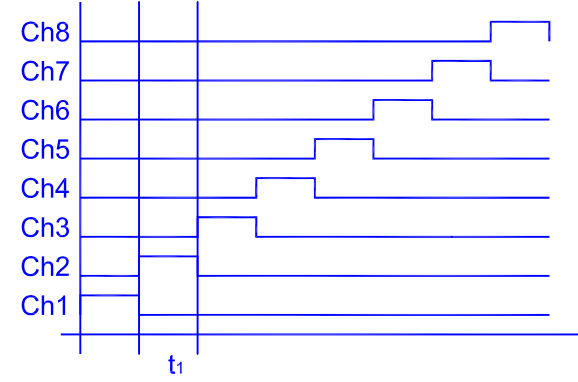

Standard timing:
 t_1 : 3~17 Sec, 6~35 Sec
 (pot selectable)

Time



Seq #4

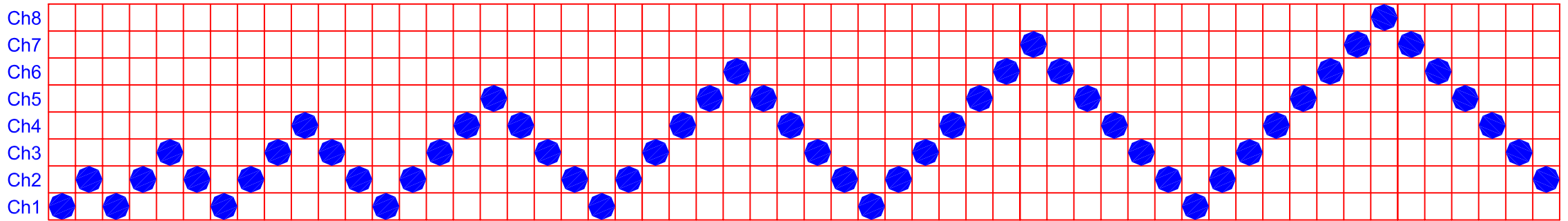

Seq #5

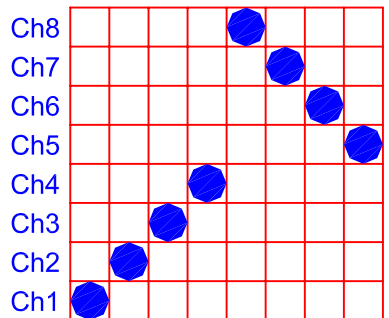

Seq #6

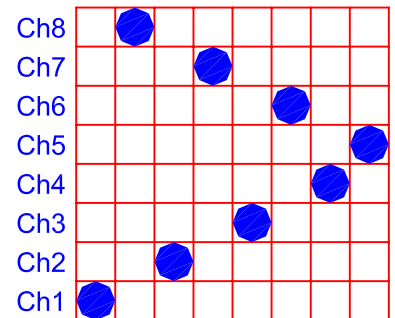

Seq #7

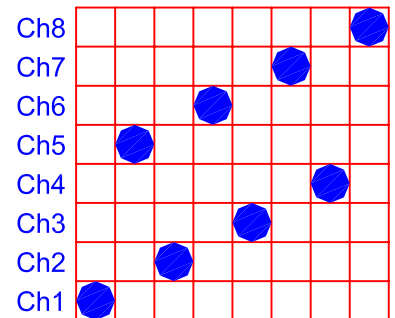

THIS ITEM IS THE PROPERTY OF PFC AND CONTAINS PROPRIETARY CONFIDENTIAL AND TRADE SECRET INFORMATION. THE INFORMATION CONTAINED HEREIN MUST NOT BE USED, DISCLOSED OR REPRODUCED IN WHOLE OR IN PART WITHOUT PRIOR WRITTEN CONSENT FROM PFC.

UNLESS OTHERWISE SPECIFIED		APPROVAL DATE		10/05/05		PFC Corporation	
DIMENSIONS ARE IN INCHES [MM]		CHECKED BY					
TOLERANCES: .X DECIMALS± .05 [1.3] .XX DECIMALS± .02 [0.5] .XXX DECIMALS± .005 [0.13]		APPROVED BY				TITLE: PREDEFINED SEQUENCES	
ANGLES± 1° FRACTIONS± 1/16		DO NOT SCALE THIS DRAWING		INTERPRET DRAWING PER ANSI Y14.5M		MODEL NO. TBD	
						DWG NO. 01-0102	
						REV. SHEET OF A 1 1	

REVISIONS		
REV	DESCRIPTION	DATE
A	RELEASE TO PRODUCTION	

4 CHANNELS

Seq #1

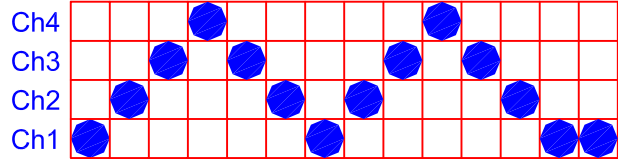

Seq #2

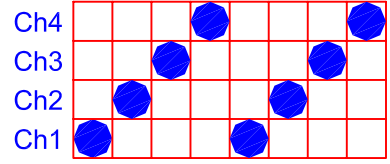

Seq #3

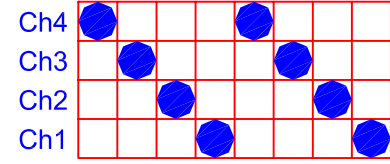

Seq #4

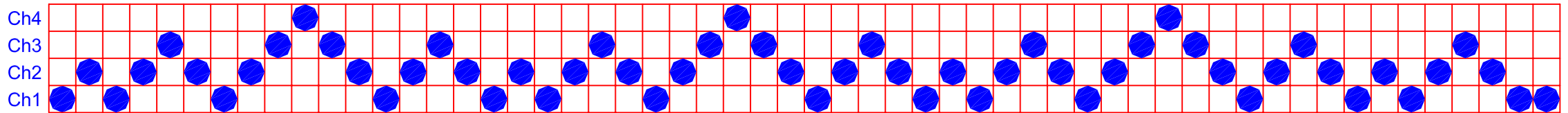

Seq #5

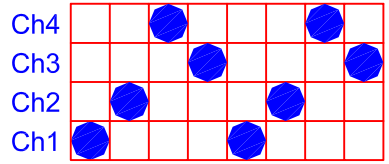

Seq #6

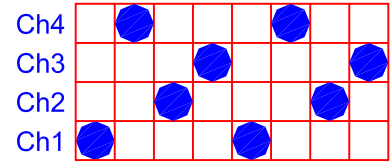

Seq #7

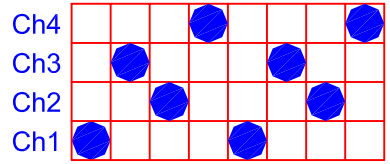

Fading

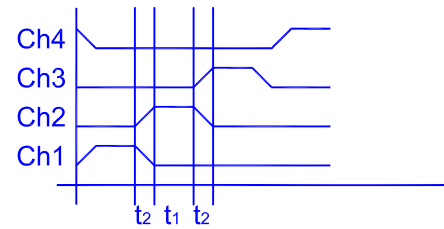

Standard timing:
 t1: 3~17 Sec, 6~35 Sec
 (pot selectable)
 t2: 5.5 Sec, 13.5 Sec

non-Fading

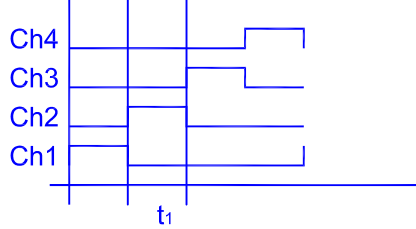

THIS ITEM IS THE PROPERTY OF PFC AND CONTAINS PROPRIETARY CONFIDENTIAL AND TRADE SECRET INFORMATION. THE INFORMATION CONTAINED HEREIN MUST NOT BE USED, DISCLOSED OR REPRODUCED IN WHOLE OR IN PART WITHOUT PRIOR WRITTEN CONSENT FROM PFC.

UNLESS OTHERWISE SPECIFIED		APPROVAL DATE		10/05/05		PFC Corporation	
DIMENSIONS ARE IN INCHES [MM]		CHECKED BY					
TOLERANCES: .X DECIMALS± .05 [1.3] .XX DECIMALS± .02 [0.5] .XXX DECIMALS± .005 [0.13]		APPROVED BY				MODEL NO. TBD	
ANGLES± 1° FRACTIONS± 1/16		DO NOT SCALE THIS DRAWING INTERPRET DRAWING PER ANSI Y14.5M				DWG NO. 01-0106	
						REV. SHEET OF A 1 1	