

# HE8811

## GaAlAs Infrared Emitting Diode

ODE-208-051 (Z)  
Rev.0  
Oct. 30, 2006

### Description

The HE8811 is a GaAlAs infrared emitting diode with a double heterojunction structure. Its high brightness, high output power and fast response make it suitable as a light source in measuring instruments and infrared-beam communication equipment.

### Features

- High-frequency response
- High efficiency and high output power
- Broad radiation pattern

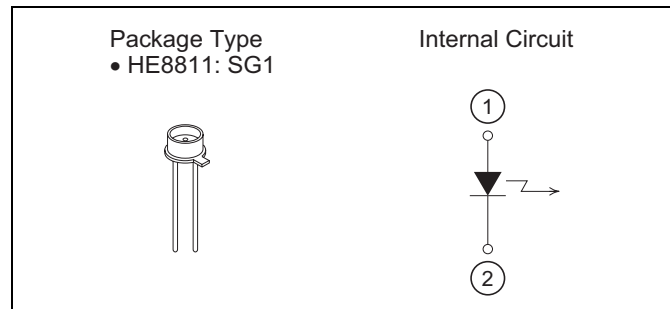

### Absolute Maximum Ratings

( $T_C = 25^\circ\text{C}$ )

Item	Symbol	Ratings	Unit
Forward current	$I_F$	200	mA
Reverse voltage	$V_R$	3	V
Operating temperature	$T_{opr}$	-20 to +60	$^\circ\text{C}$
Storage temperature	$T_{stg}$	-40 to +90	$^\circ\text{C}$

### Optical and Electrical Characteristics

( $T_C = 25^\circ\text{C}$ )

Item	Symbol	Min	Typ	Max	Unit	Test Conditions
Optical output power	$P_O$	20	30	—	mW	$I_F = 150 \text{ mA}$
Peak wavelength	$\lambda_p$	780	820	900	nm	$I_F = 150 \text{ mA}$
Spectral width	$\Delta\lambda$	—	50	—	nm	$I_F = 150 \text{ mA}$
Forward voltage	$V_F$	—	—	2.5	V	$I_F = 150 \text{ mA}$
Reverse current	$I_R$	—	—	100	$\mu\text{A}$	$V_R = 3 \text{ V}$
Capacitance	$C_t$	—	10	—	pF	$V_R = 0 \text{ V}, f = 1 \text{ MHz}$
Rise time	$t_r$	—	5	—	ns	$I_F = 50 \text{ mA}$
Fall time	$t_f$	—	7	—	ns	$I_F = 50 \text{ mA}$

### Typical Characteristic Curves

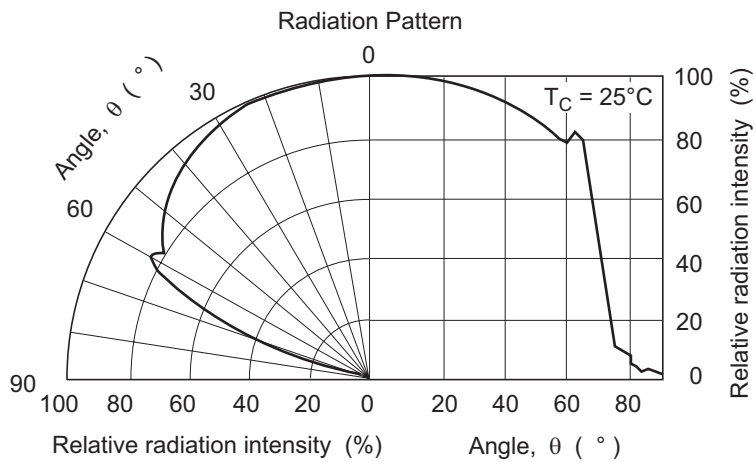
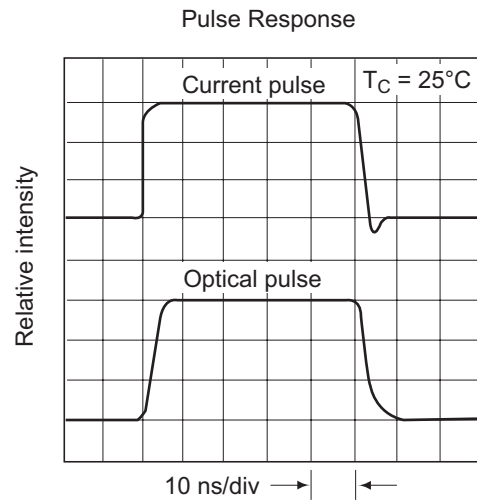
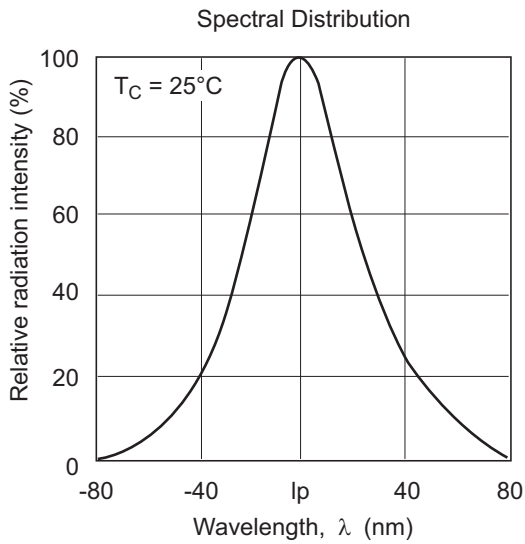
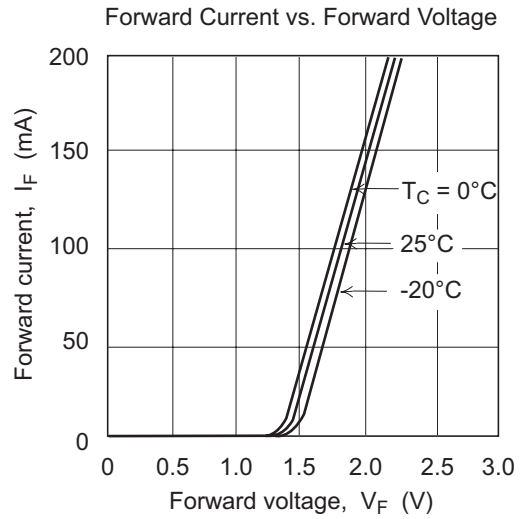
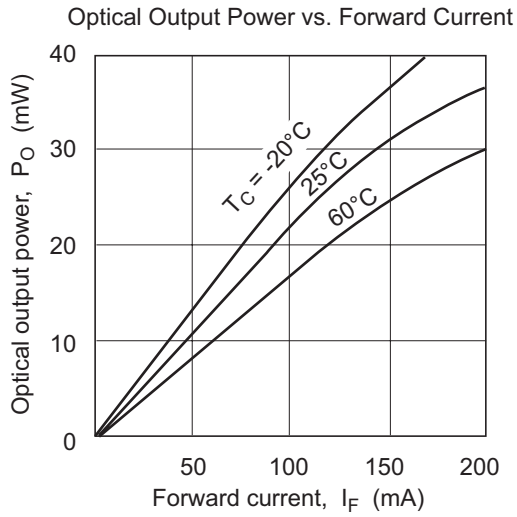

Package Dimensions

As of July, 2002  
Unit: mm

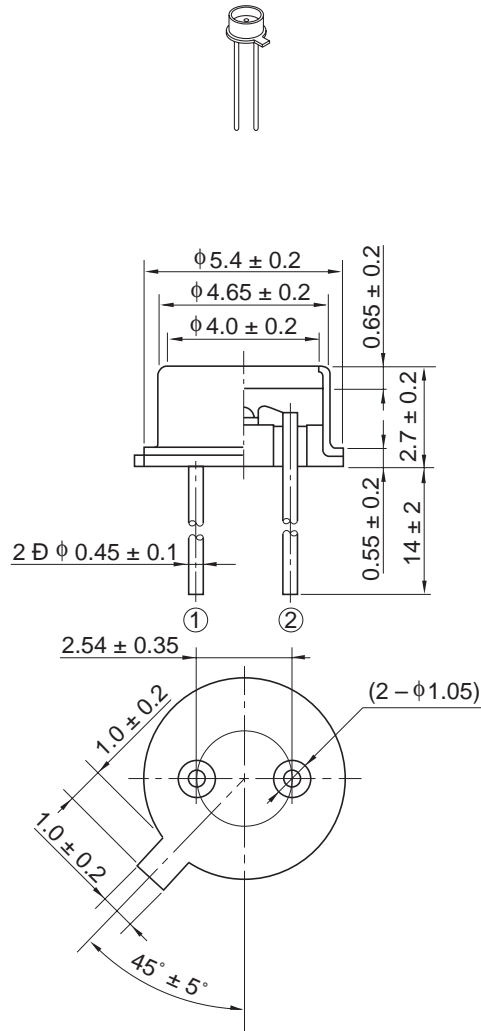

OPJ Code	IR/SG1
JEDEC	—
JEITA	—
Mass (reference value)	0.25 g

## Cautions

1. Opnext Japan, Inc. (OPJ) neither warrants nor grants licenses of any of our rights or any third party's patent, copyright, trademark, or other intellectual property rights for information contained in this document. OPJ bears no responsibility for problems that may arise with third party's rights, including intellectual property rights, in connection with use of the information contained in this document.
2. Products and product specifications may be subject to change without notice. Confirm that you have received the latest product standards or specifications before final design, purchase or use.
3. OPJ makes every attempt to ensure that its products are of high quality and reliability. However, contact our sales office before using the product in an application that demands especially high quality and reliability or where its failure or malfunction may directly threaten human life or cause risk of bodily injury, such as aerospace, aeronautics, nuclear power, combustion control, transportation, traffic, safety equipment or medical equipment for life support.
4. Design your application so that the product is used within the ranges guaranteed by OPJ particularly for maximum rating, operating supply voltage range, heat radiation characteristics, installation conditions and other characteristics. OPJ bears no responsibility for failure or damage when used beyond the guaranteed ranges. Even within the guaranteed ranges, consider normally foreseeable failure rates or failure modes in semiconductor devices and employ systemic measures such as fail-safes, so that the equipment incorporating OPJ product does not cause bodily injury, fire or other consequential damage due to operation of the OPJ product.
5. This product is not designed to be radiation resistant.
6. No one is permitted to reproduce or duplicate, in any form, the whole or part of this document without written approval from OPJ.
7. Contact our sales office for any questions regarding this document or OPJ products.

1. The laser light is harmful to human body especially to eye no matter what directly or indirectly. The laser beam shall be observed or adjusted through infrared camera or equivalent.
2. This product contains gallium arsenide (GaAs), which may seriously endanger your health even at very low doses. Please avoid treatment which may create GaAs powder or gas, such as disassembly or performing chemical experiments, when you handle the product.  
When disposing of the product, please follow the laws of your country and separate it from other waste such as industrial waste and household garbage.
3. Definition of items shown in this CAS is in accordance with that shown in Opto Device Databook issued by OPJ unless otherwise specified.

## Sales Offices



### Device Business Unit Opnext Japan, Inc.

Takagi Bldg., 3F, 1-3-9, Iwamoto-cho, Chiyoda-ku, Tokyo 101-0032 Japan  
Tel: (03) 3865-5591

For the detail of Opnext, Inc., see the following homepage:

Japan (Japanese) <http://www.opnext.com/jp/products/>  
Other area (English) <http://www.opnext.com/products/>

©2007 Opnext Japan, Inc., All rights reserved. Printed in Japan.  
Colophon 2.0