

# Ambient Light Sensors SFH3410, SFH3710

## Application Note

---

### **Abstract**

This application note describes the ambient light sensors SFH 3710 and SFH 3410. Both sensors are photo transistors which are especially adapted to the human eye.

### **Introduction**

Osram OS has developed the SFH 3710 and SFH 3410 as low cost ambient light sensors. Both devices are Silicon Phototransistors in small and flat SMT packages.

### **Applications for ambient light sensors**

Ambient light sensors are designed to detect brightness in the same way as human eyes do. They are used wherever the settings of a system have to be adjusted to the ambient light conditions as perceived by humans:

- Saving battery power  
These sensors provide low cost power saving solutions for hand-held electronic devices such as PDAs, mobile phones and notebook PCs. Nearly all LCD displays and keypads have backlighting. Studies have shown that backlighting is only required about 40% of the time. If you have a way to automatically adjust (auto dimming) the backlighting to be on only when you need it you can have considerable power savings. This is welcome news for battery powered devices.
- Automatic dimming of flat panel displays such as LCD screens to maintain the same display appearance under all lighting conditions from twilight to bright sunlight.
- Automatic dimming of instruments in automobiles to ensure reliable visibility under all circumstances

### **Basic facts about ambient light sensing**

#### **Brightness**

Brightness is a term that describes how intense a light source is perceived by the human eye. Brightness is measured in the units called "LUX". Light sources with the same LUX level appear at the same brightness to the human eye. **Tab. 1.0** below shows the brightness (LUX measurement) of some everyday light sources.

Light source	Illuminance [Lux]
candle (1m(3 ft) distance)	1
street light	20
office desk lighting	750
overcast day	3000
overcast sunny day	20 000
direct sunlight	100 000

**Tab. 1** Lux measurement of every day light sources.

### Spectral Sensitivity.

Spectral Sensitivity relates to where on the light spectrum the sensor is most effective. Standard silicon phototransistors have a spectral response ranging from 1100nm right down to 350nm with the peak sensitivity around 900nm. The new OSRAM OS ambient light sensors have a spectral response ranging from 1100nm right down to 350nm but with the peak sensitivity around 580nm. This peak is very similar to the human eye spectral sensitivity. The graph in **figure 1** shows the spectral sensitivity of a silicon phototransistor, an ambient light sensor and the human eye (V-lambda curve).

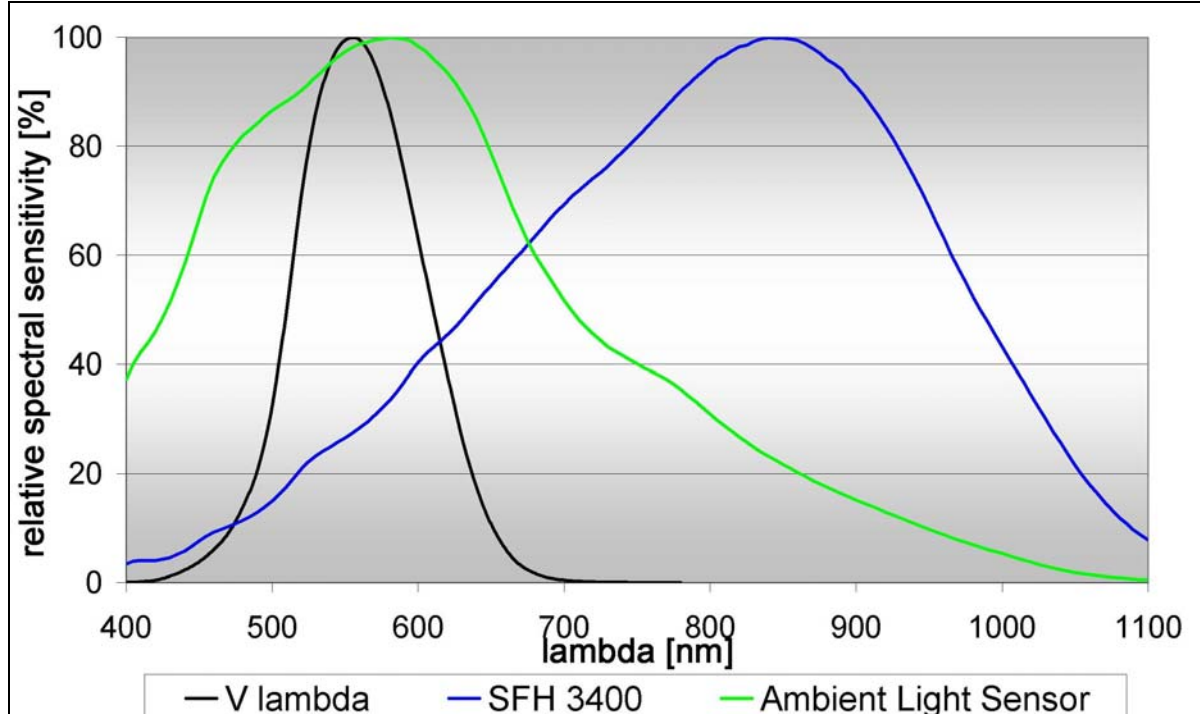
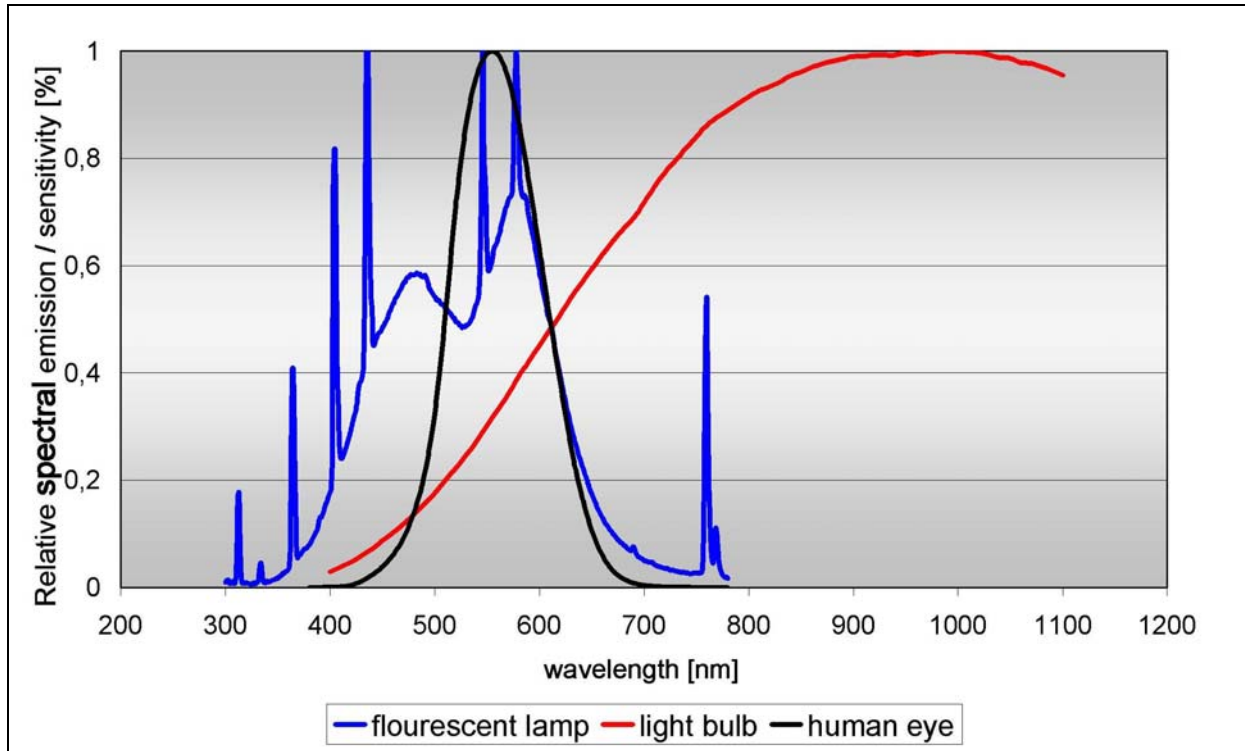

**Figure 1** Spectral sensitivity of different detectors compared to the human eye (V lambda).

## Ambient Light Sensors versus standard Silicon detectors.

Every light source emits both visible and IR light.

Different light sources can have similar visible brightness (LUX) but different IR emissions. (Figure 2)

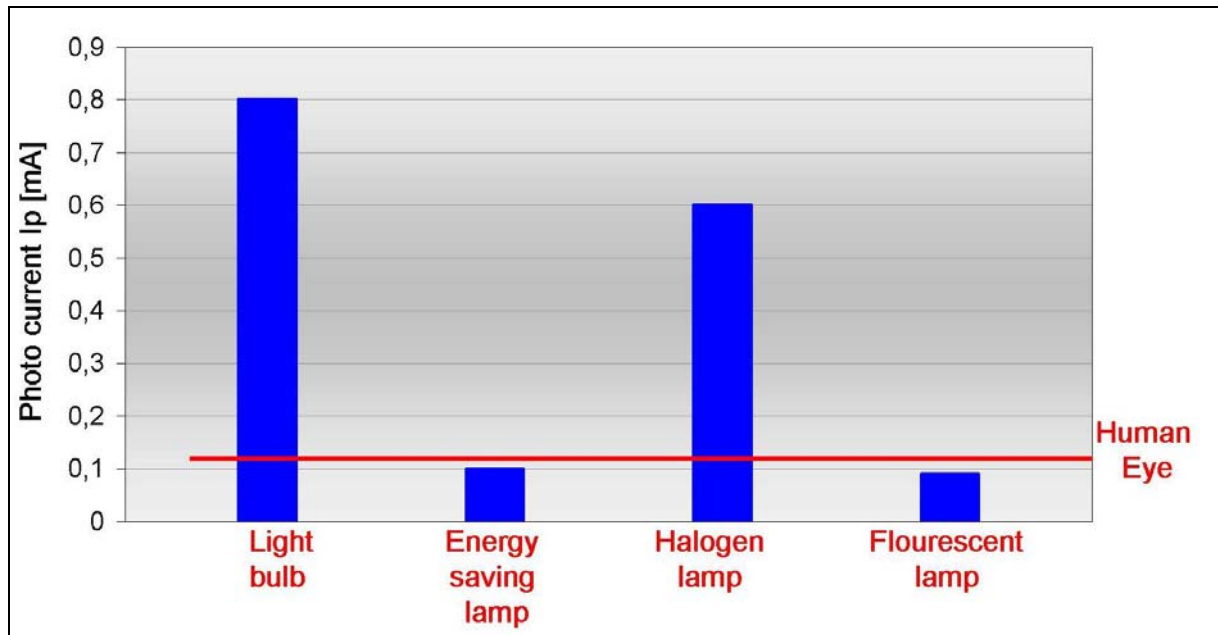

**Figure 2** spectral emission of different light sources compared to the spectral sensitivity of human eyes ( $V_{\lambda}$ )

Using silicon photo detectors that measure mostly IR emissions (peak sensitivity at 880nm) can give you a false reading as to what the real Ambient Visible conditions are.

In other words, for light sources with a high contribution of IR light, the signal received by a silicon detector would suggest a much brighter situation than our eyes actually see.

**Figure 3** shows the different signals a silicon detector yields for different light sources compared to the signals that a “human eye like” detector would see. Hence using a lighting controlled by such sensors will not resemble the optimum brightness as felt by humans. To establish a more suitable dimming or lighting control, it is essential to find a sensor which emulates human eyes as closely as possible.



**Figure 3** Signals received by a Si-Photo detector for different light sources at the same brightness compared to a detector with perfect human eye characteristics

Because the IR portion of the spectral sensitivity of ambient light sensors is greatly reduced compared to Si-Photo detectors (see **Figure 1**), they are less sensitive to the effects of different lamps. **Figure 4** shows the signals of an ambient light sensor received from different lamps compared to the signals standard photo detector. The errors that are made are greatly reduced.

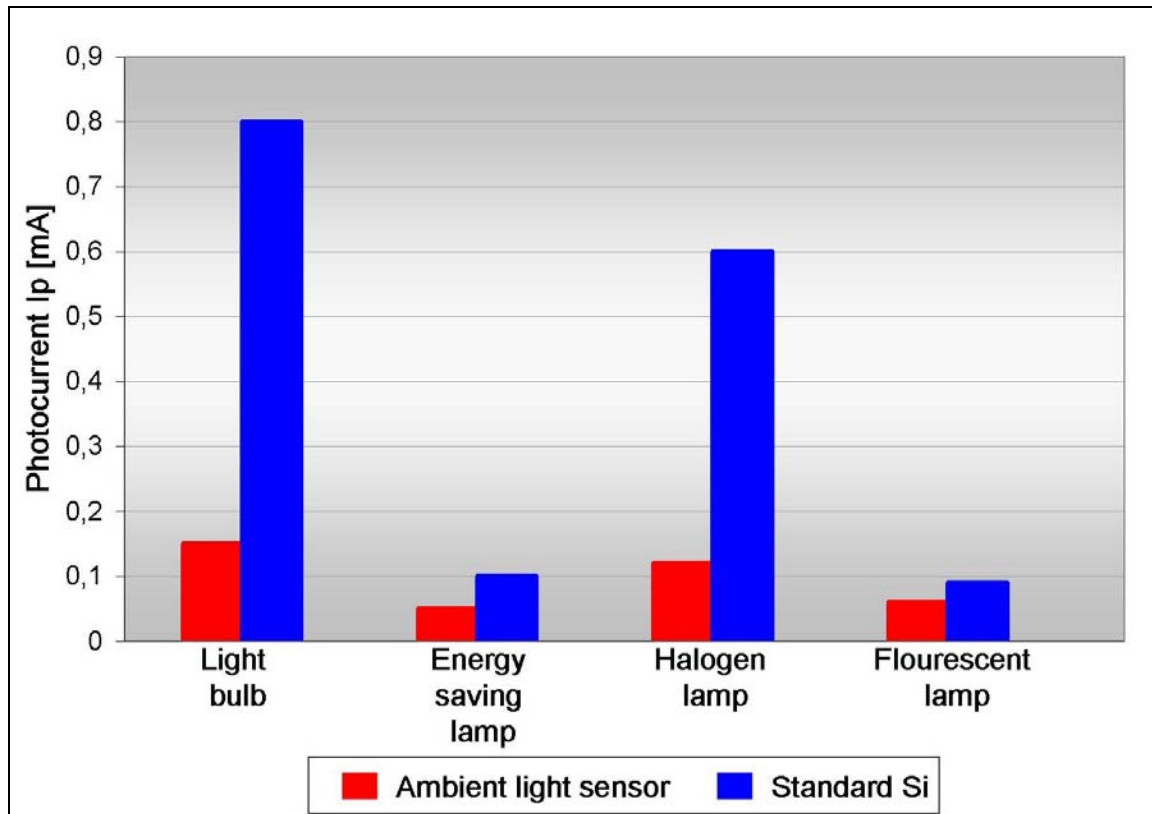
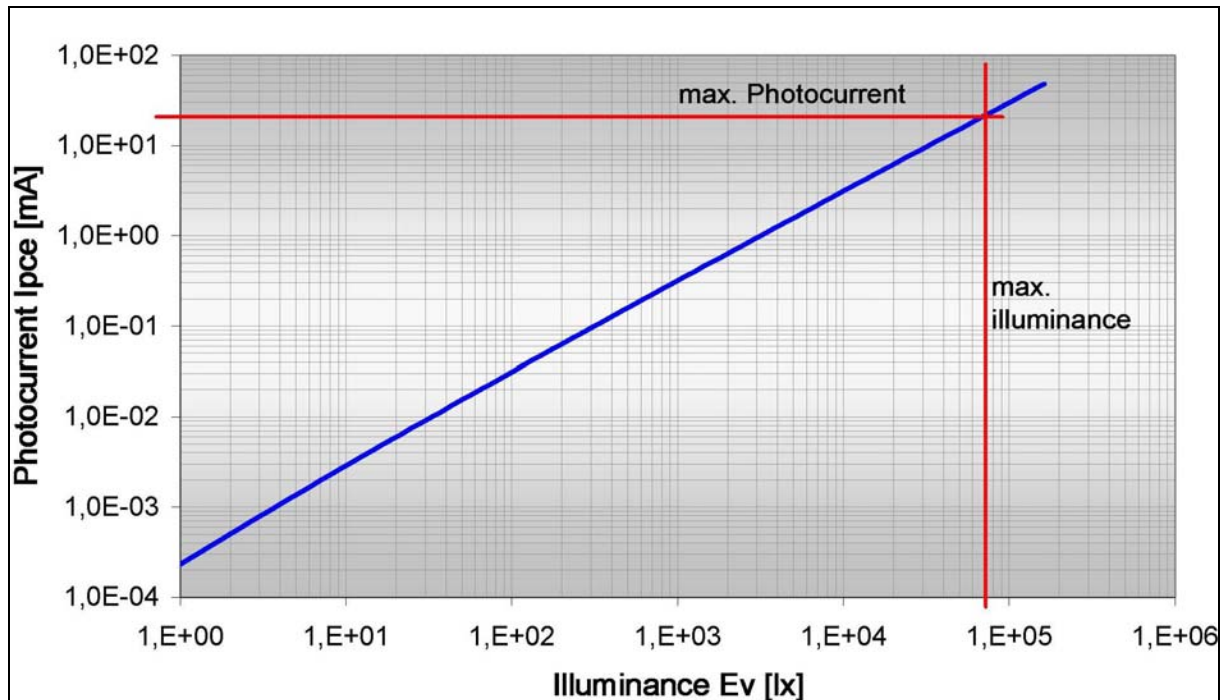

**Figure 4** Signals received by a standard photo detector and an ambient light sensor for different light sources.

#### Operation of the ambient light sensors SFH 3410 and SFH 3710<sup>(1)</sup>

Both, SFH 3410 and SFH 3710 are Silicon Phototransistors. Their output signal is an analog photocurrent  $I_{pce}$  which is proportional to the incident light level. (**Figure 5**)

(1): SFH 3710 and SFH 3410 have similar electrical and optical characteristics. All information in this paragraph is valid for both devices



**Figure 5** Output signal  $I_{pce}$  of SFH 3410 and SFH 3710 versus Illuminance.

Due to manufacturing process different phototransistors will give different outputs for the same illuminance. To account for this, OSRAM offers the designer a choice of binning options. **Table 2** gives a summary of the binning options for the SFH 3410 and SFH 3710

SFH 3410	$I_{pce}$ @ 20lx [ $\mu$ A]	SFH 3710	$I_{pce}$ [ $\mu$ A] @ $E_e = 10\mu\text{W}/\text{cm}^2$ , $\lambda = 560\text{nm}$
SFH 3410-1	3.2 ... 6.3	SFH 3710-2	2.5 ... 5
SFH 3410-2	5 ... 10	SFH 3710-3	4 ... 8
SFH 3410-3	8 ... 16	SFH 3710-4	6.3 ... 12.5
SFH 3410-4	12.5 ... 25		

**Table 2** Sensitivity binning for SFH 3410 and SFH 3710

The phototransistors can be operated with different circuits (**Figure 6** a-c).

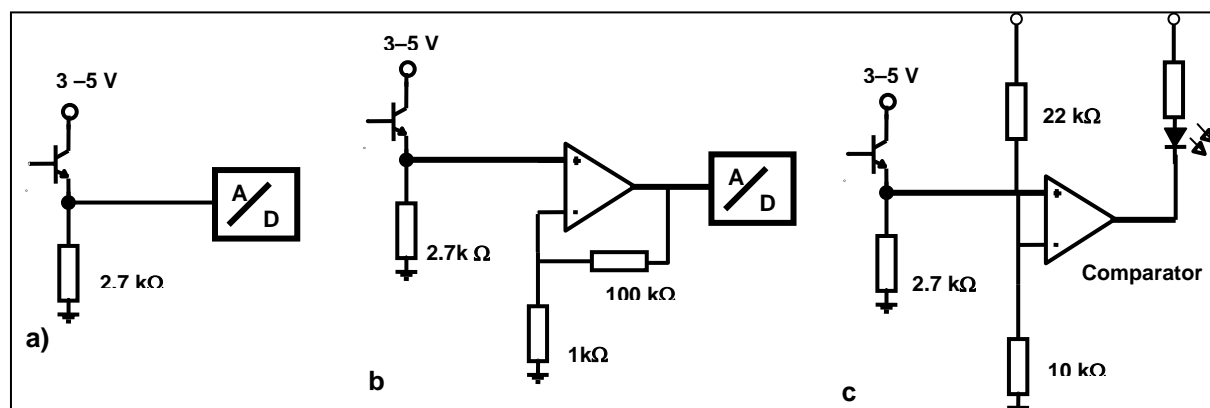

**Figure 6** Different circuits for ambient light phototransistors:

- a): analog signal  $I_{pce}$  is used directly. This circuit is suitable for  $E_v = 10lx \dots 1000lx$ ;
- b):  $I_{pce}$  is amplified. This circuit is suitable if sensor is mounted behind displays,  $E_v = 0.1lx \dots 10lx$
- c): In this circuit the lightsource is controlled by a comparator.

An evaluation board with different circuits together with a detailed description of the boards can be obtained through the OSRAM OS sales representatives. The board enables the designer to test the ambient light sensor under different lighting conditions and get a feeling for its output signals under those conditions. <sup>(2)</sup>

### **Features of the ambient light sensors SFH 3710 and SHF 3410**

**Table 3** summarizes the main features of the ambient light sensors SFH 3710 and SFH 3410. Both parts are phototransistors with ambient light characteristics. Their main differences are package and spectral sensitivity. The spectral sensitivity of the SFH 3710 is improved compared to the SFH 3410.

**(2)** Since ambient light sensors are used increasingly for backlight control, some LED driver suppliers have implemented an interface to an ambient light sensor into their devices.

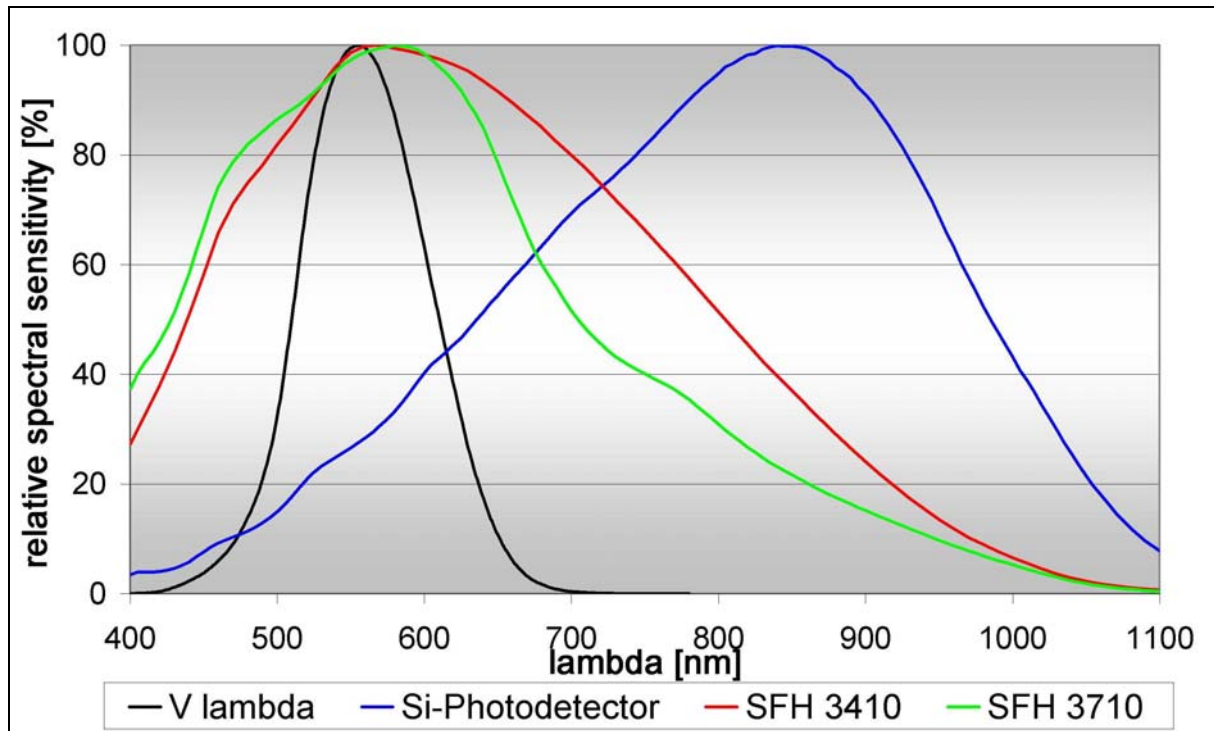

**Figure 6:** spectral sensitivity of SFH 3410 and SFH 3710 compared to human eyes and standard Si Photo detector

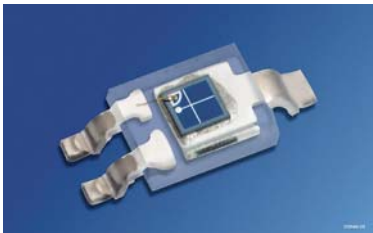
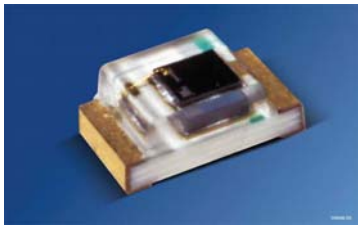
Parameter	SFH 3410	SFH 3710
		
Functionality	Phototransistor	Phototransistor
package	SmartDIL	ChipLED
Size (LxBxH)[mm]	4.6 x 2.0 x 1.1	2.0 x 1.6 x 0.8
Temperature range Top [°C]	-40 ... +100	-40 ... +85
Wavelength of max. sensitivity	570nm	570nm
Radiant sensitive Area [mm <sup>2</sup> ]	0.29	0.29
Photocurrent I <sub>pce</sub> [mA] @ E <sub>v</sub> = 1000lx	0.5 typ.	0.5 typ.
Sensitivity Binning	Bins with +-30% sensitivity variation per bin	

For further details, please refer to the datasheets. Both devices are RoHS compliant.



Authors: Dr. Christine R uth, Andreas Vogler, Wilhelm Karsten

#### **About Osram Opto Semiconductors**

**Osram Opto Semiconductors GmbH, Regensburg, is a wholly owned subsidiary of Osram GmbH, one of the world's three largest lamp manufacturers, and offers its customers a range of solutions based on semiconductor technology for lighting, sensor and visualisation applications. The company operates facilities in Regensburg (Germany), San Jos  (USA) and Penang (Malaysia). Further information is available at [www.osram-os.com](http://www.osram-os.com).**

All information contained in this document has been checked with the greatest care. OSRAM Opto Semiconductors GmbH can however, not be made liable for any damage that occurs in connection with the use of these contents.