

SPECIFICATIONS FOR UPEC LAMP TYPE GREEN LED

MODEL: UE-LD400PG0-4TSI

Features

- High Luminous intensity
- Elliptical LED Lamp
- General purpose leads
- Reliable and rugged

Package Dimensions

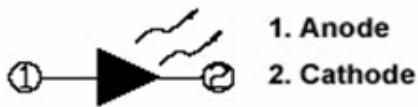
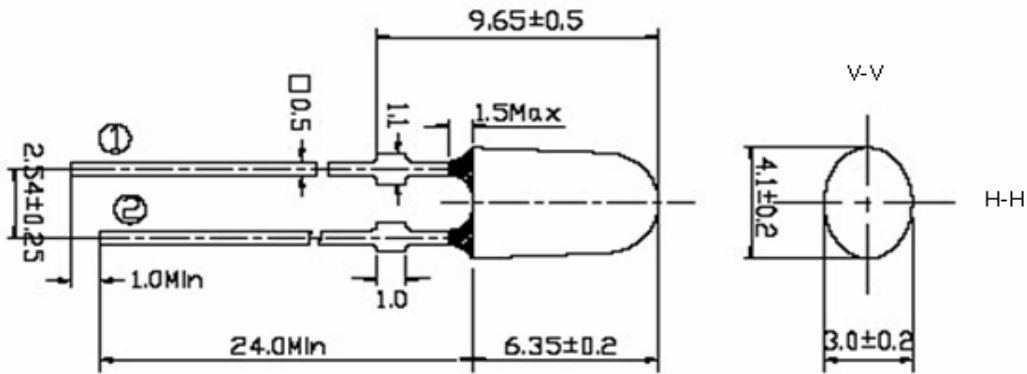

Part NO.	Chip Material	Lens Color	Source Color
UE-LD400PG0-4TSI	InGaN	Color Diffused	Green

Notes

1. All dimensions are in millimeters .
2. Tolerance is ± 0.25 mm unless otherwise noted.
3. Protruded resin under flange is 1.5mm max.
4. Lead spacing is measured where the leads emerge from the package.

Mark	Date	Description Approve	Approved	Checked	Symbol	UPEC LED
-	MAR/03/05		Joseph	Stone	Name	UE-LD400PG0-4TSI
					Drawing No	WIENDS435

Absolute Maximum Ratings at Ta=25

Parameter	Symbol	Max	Unit
Power Dissipation	PD	110	mW
Pulse Forward Current	IPF	100	mA
Forward Current	IF	30	mA
Reverse Voltage	VR	5	V
Operating Temperature Range	Topr	- 20 to + 75	°C
Storage Temperature Range	Tstg	- 30 to + 80	°C
Lead Soldering Temperature [1.6mm (0.063inch) From Body] 260 °C For 5 Seconds			

Electrical / Optical Characteristics at Ta=25

Parameter	Symbol	Min.	Typ.	Max.	Unit	Test Condition
Luminous Intensity	Iv	310	460	---	mcd	IF=20mA
50% Power Angle	2 θ _{1/2} H-H	---	50	---	Deg	IF=20mA
	2 θ _{1/2} V-V	---	110	---	Deg	IF=20mA
Dominant Wavelength	λ _d	---	525	---	nm	IF=20mA
Forward Voltage	V _F	3.0	---	4.0	V	IF=20mA
Reverse Current	I _R	---	---	100	μA	VR = 5V

BIN	LM	LN	LO	---	---	---
Range	310-460	460-690	690---	---	---	---

Measurement Uncertainty of the Luminous Intensity: ± 15%

Measurement Uncertainty of the Dominant Wavelength: ±1nm

Measurement Uncertainty of the Forward Voltage: ±0.1V

Notes

- Luminous intensity is measured with a light sensor and filter combination that approximates the CIE eye-response curve.
- θ_{1/2} is the off-axis angle at which the luminous intensity is half the axial luminous intensity.
- The dominant wavelength (λ_d) is derived from the CIE chromaticity diagram and represents the single wavelength which defines the color of the device.

			Approved	Checked	Symbol	UPEC LED
			Joseph	Stone	Name	UE-LD400PG0-4TSI
					Drawing No	WIENDS435
-	MAR/03/05					
Mark	Date	Description Approve				

Typical Electrical / Optical Characteristics Curves

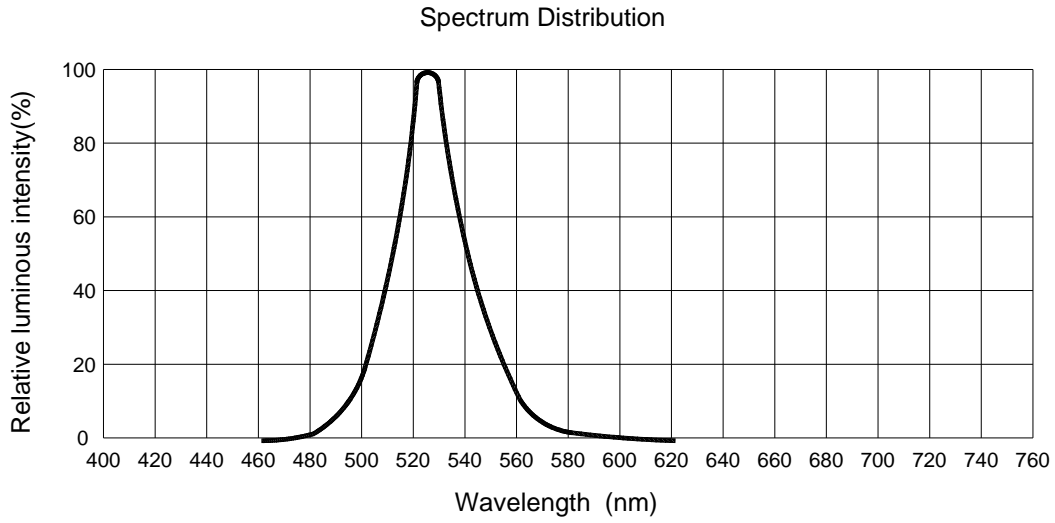

Forward Current VS. Forward Voltage

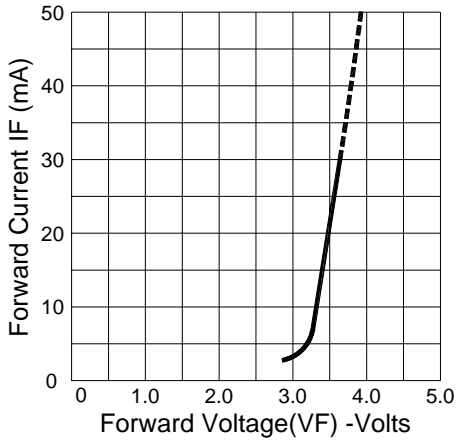

Luminous Intensity VS. Forward Current

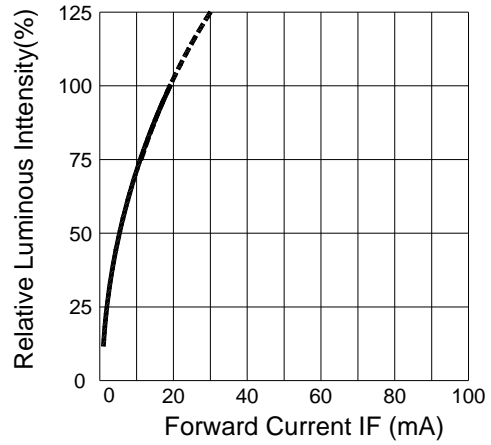

Forward Current VS. Ambient Temperature

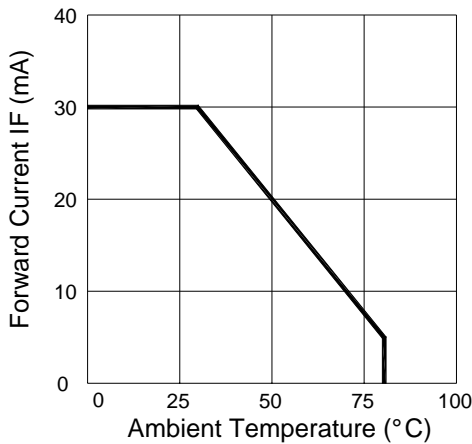

Radiation Diagram

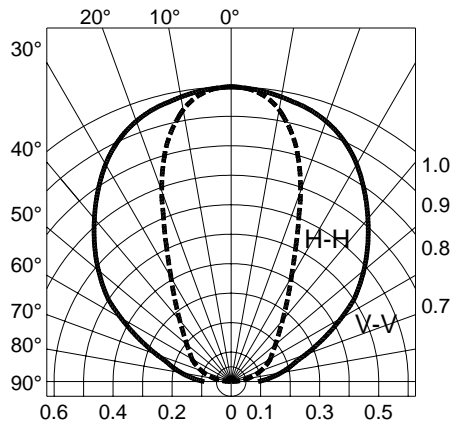

			Approved	Checked	Symbol	UPEC LED
			Joseph	Stone	Name	UE-LD400PG0-4TSI
-	MAR/03/05				Drawing No	WIENDS435
Mark	Date	Description Approve				

Reliability Test Items and Conditions

No.	Item	Test Conditions	Test Hours / Cycle	Sample Q'ty	Ac/Re
1	Solder Heat	TEMP : 260 ±5	5 sec	22 pcs	0/1
2	Temperature Cycle	H : +85 30min. ∩ 5min. L : -35 30min.	50 cycle	22 pcs	0/1
3	Thermal Shock	H : +85 ∩ 5min. L : -35 5min.	50 cycle	22 pcs	0/1
4	High Temperature Storage	TEMP : 85	1000 hrs	22 pcs	0/1
5	Low Temperature Storage	TEMP : -35	1000 hrs	22 pcs	0/1
6	DC Operating Life	I _F = 20mA	1000 hrs	22 pcs	0/1
7	High Temperature / High Humidity	65 / 85 ~ 90% R.H.	1000 hrs	22 pcs	0/1

Judgment Criteria

Forward Voltage Vf	V _{fmax} Increase < 1.2x
Reverse Current Ir	I _{rmax} Increase < 2x
Luminous Intensity Iv	Iv Decay < 50%

Note : Measurement shall be taken after the tested samples have been returned to normal ambient conditions (generally after two hours)

			Approved	Checked	Symbol	UPEC LED
			Joseph	Stone	Name	UE-LD400PG0-4TSI
					Drawing No	WIENDS435
-	MAR/03/05					
Mark	Date	Description Approve				