



ALPHA 1655 HS Plus

Schnurloses Telefon nach CT+ Standard
inklusive Headset

BEDIENUNGSANLEITUNG

INSTRUCTION MANUAL

MODE D'EMPLOI

TABLE OF CONTENTS

TABLE OF CONTENTS	1-2
INTRODUCTION / BEFORE USE	3-7
SECTION A FUNCTION DESCRIPTION	8
1. Phone On from Standby State	8
2. Phone Off	8
3. Make Call	8
4. Make a New Call in the Phone state	8
5. Call Answering	8
6. Pre-dialing	8-9
7. Last number Redial	9
8. Memory dialing	9
9. Extended Redial	9
10. Temporary Tone Mode (optional, country dependent)	9-10
11. Emergency Call /Baby Call	10
12. Microphone Mute	10
13. Base Paging	10
14. Call Barring	10
15. Battery Low Warning	10-11
16. Battery Level indication	11
17. Out of Range Warning	11
18. Key Lock	11
19. Recall	12
20. Awado mode	12
21. Comfort Features in the Telekom Network	12
SECTION B PROGRAMMING PROCEDURE DESCRIPTIO	13
1. Key Touch Tone Enable/Disable	13
2. Ringer Tone Select	13
3. Ringer Loudness Select	13
4. Auto Phone On	14
5. Baby Call	14

TABLE OF CONTENTS

6. Key Lock	14
7. Setting Barring Number for Call Barring	15
8. Setting tone/pulse dialing (Optional, country dependent)	15
9. Reset to default values	15-16
10. Program Personal Identity Number (PIN)	16
11. Extended Redial	16
12. Programming Memory	16-17
13. Selecting Signal [R] (Optional, country dependent)	17
14. Programming Key List	17-18
SECTION C DEFAULT SETTING	19

Precaution

Emergency calls (baby call function) are not available
in case of power failure.

Use only rechargeable batteries.

Replace only with the same or equivalent
type recommended by the manufacturer.

Attention should be drawn to the
environmental aspects of battery disposal.

INTRODUCTION / BEFORE USE

DEAR CUSTOMER

*For user notes and tips
"How to extend the life
of your battery", see
pp. 19.*

NOTE

We are glad that you have decided for this Phone. The product you have bought is state of the art, of highest quality and has many advanced features.

Please read this Instruction Manual carefully so that you get the most from your phone .

The purpose of the Instruction Manual is to provide information. Its content is not the subject of contract. All data in this booklet is merely nominal. The right to technical modifications is reserved.

Closing date: 10/2001

BATTERY INSTALLATION

- a) The battery cover is on the back side of the unit. Push it in the arrowed direction and remove it.
- b) Insert the 3 supplied "AAA" size, NiMH (3 x 550mAh) storage batteries as shown here (Fig 1). Ensure correct polarity.
- c) Close the battery compartment.

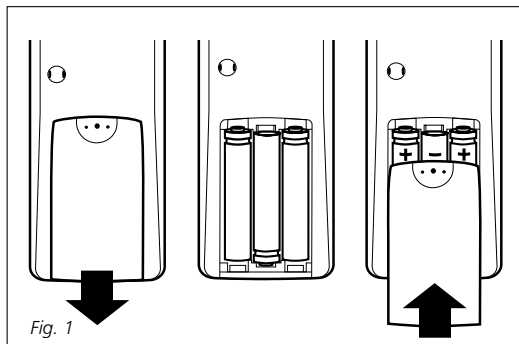

NOTE

Before first use, load up the storage batteries in the base unit 10 hours at least.

BEFORE USE

PARTS AND ACCESSORIES

Fig. 2

After unpacking the unit, please make sure the parts below are counted for:

- 1 Handset with storage batteries
- 2 Base unit
- 3 Telephone connection with cord
- 4 Power supply adaptor with cord
- 5 Belt clip
- 6 Headset
- 7 Instruction manual (no figure)

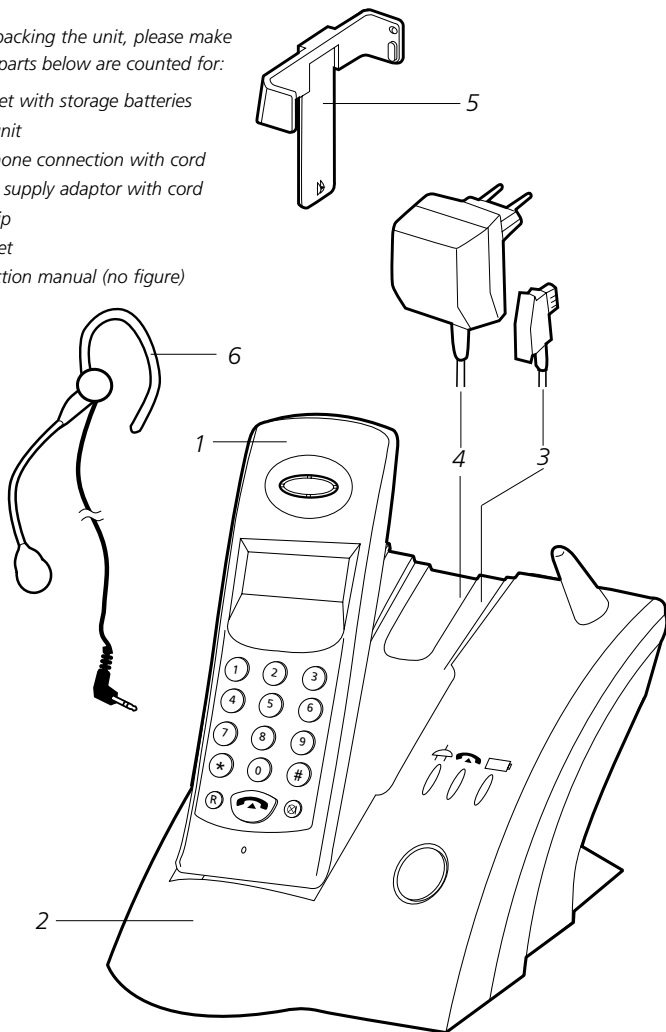

BEFORE USE

CONNECTING THE UNIT

As shown in the figure below, insert one end of the telephone cord into the wall jack and the other end into the opening at the underside of the unit.

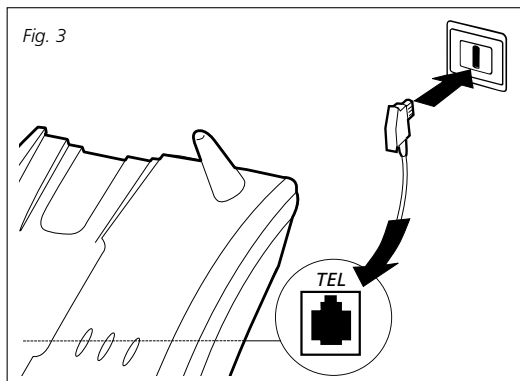

As shown in the figure below, insert one end of the power cord into the 230 V AC outlet and the other end into the opening at the underside of the unit.

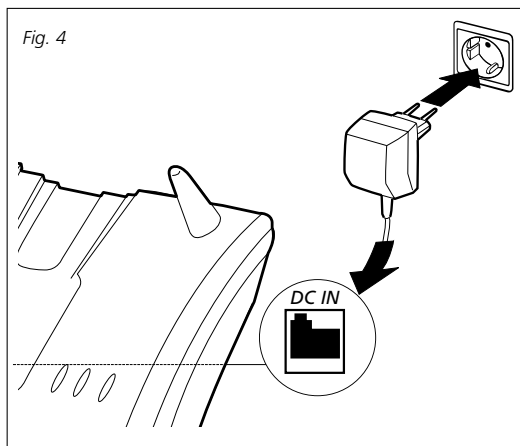

BEFORE USE

BASE UNIT

(PARTS BY USING HANDSET)

Fig. 5

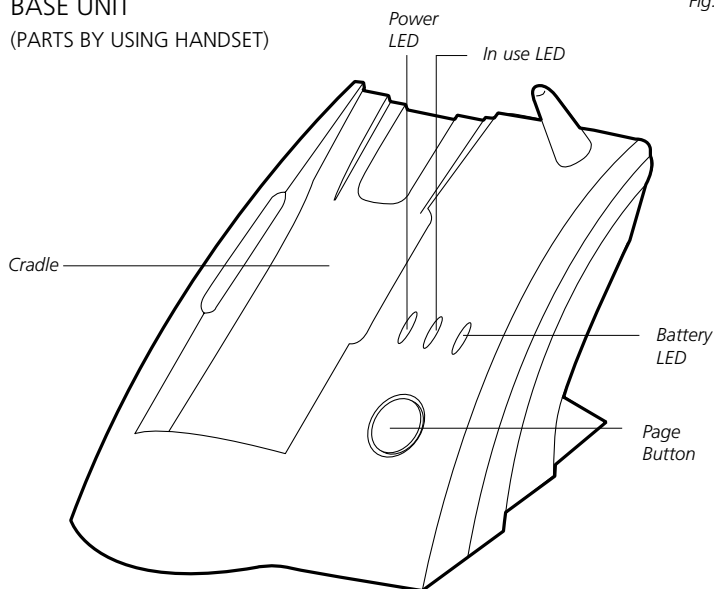

DISPLAY ICONS

(HANDSET)

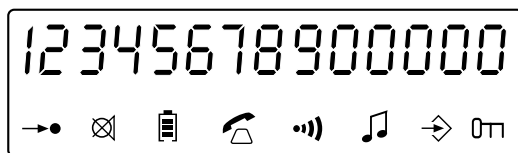

→● Memory icon

⊗ Mic icon

🔋 Battery icon

📞 In use icon

📶 Paging icon

🎵 Tone icon

➡️ Programming icon

🚫 Barring icon

📱 7-Digit-sign
for numbers
and letters

BEFORE USE

HANDSET

Fig. 6

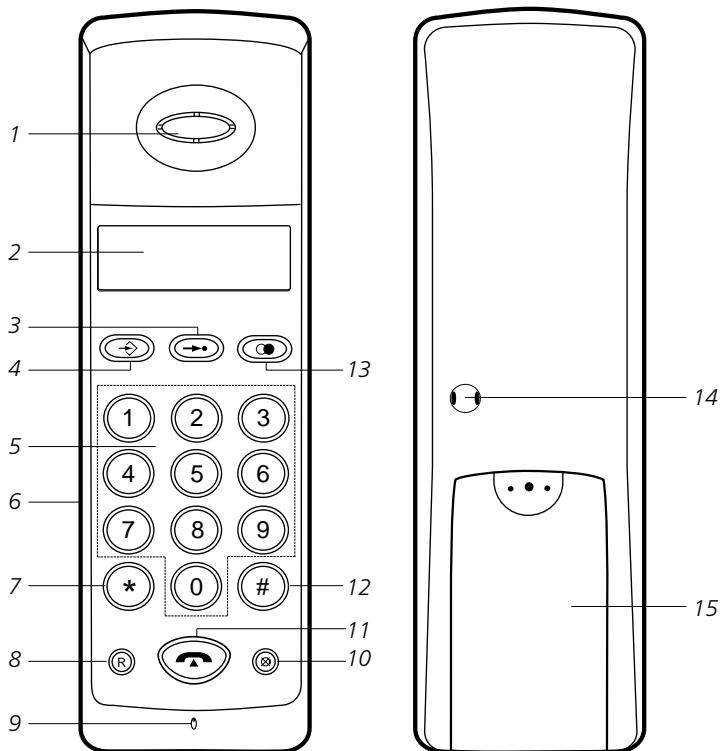

1 Earpiece

2 LCD

3 Memory key

4 Programming key

5 Number keys

6 Headset connection

7 Star key

8 Signal key

10 Mic key

11 Call key

12 Rhomb key

13 Redial key



14 Sound opening

15 Battery cover



SECTION A

FUNCTION DESCRIPTION

1. Phone On from Standby State

- Press [] button, key tone will be heard, a phone icon [] will flash on LCD.
- If linking success, [] is on. In use LED on base is on. After 5 sec. and then in stead of Call Time.
- If linking fails after 5 sec. 3 long beep fail tone will be heard.

2. Phone Off

- Press [] button again, Handset exits phone state.
- Return Handset to cradle also exits phone state.
- Phone_on icon [] on handset and In use LED on base will be off.
- Call time on LCD is off after a while.



3. Make Call

- Press [] button to link up the line.
- Hearing dial tone and then dial telephone number.
- LCD shows the Telephone Number you dial.

4. Make a New Call in the Phone state

- During phone state, press and hold the [] button for 1 sec. 2 beep tone will be heard.
- Hearing dial tone and dial the new telephone number.
- LCD shows the Telephone Number you dial.

5. Call Answering

- During ring in, the special ring sound on H/S and B/S will be heard, [] on LCD will flash.
- Press [] button to answer the call.
- When H/S is in cradle, pick up H/S, the call will be received automatically if H/S is set to Auto Phone on by programming.

6. Pre-dialing

- Before Phone on, Enter a Tel. no. (up to 24 digits available) on LCD.
- Press [] button to make Phone on, the line will

SECTION A

FUNCTION DESCRIPTION

be linked up and the Tel. no. will be sent automatically.

- During digit entering, LCD will shows the Tel. no. one by one. User can press [✕] button to perform backspace function. If depress [✕] button for 1 sec., whole entry will be erased.
- Leave the handset without pressing any key for 15 sec., the pre-entered digit will be clear and the handset will go back to normal.

7. Last number Redial

- During phone state, Pressing [●] button, The last number dialed will be shown on LCD and sent to telephone line.
- It can also be used in pre-digit dialing. Pressing [●] button, LCD shows the last number dialed. If it exceeds 24 digits, the process will be invalid.

8. Memory dialing

- During in phone state, press [→●] button and memory location from "0" to "9".
- The Tel. no. pre-stored by programming will be dialed out.
- It can also be used in pre-dialing.
- The contents of memory stored will be stored or cleared by programming process.

9. Extended Redial

- It is used to redial an extra memory for last number dialed.
- During in phone state, press [→●] + [●] to dial out the pre-stored extending redial digits.
- The contents of extra memory will be stored or cleared by programming process.

10. Temporary Tone Mode (optional, country dependent)

- During pulse dialing, press [*] button to change pulse dialing to tone dialing temporarily.
- A 3s/6s pause (optional depend on deferent country)

SECTION A

FUNCTION DESCRIPTION

will be attached automatically.

- The temporary tone function can also be used in pre-dialing and storing memory redial.



11. Emergency Call (Baby Call)

- When emergency call function is enabled by program setting, Only the pre-programmed Tel. no. ("mem 0") can be dialed out if any button is pressed except for [] key.
- The emergency call is invalid if "mem 0" is not pre-programmed.

NOTE:

When Emergency Call (Baby Call) is activated, H/S can enter to Remote control mode.

12. Microphone Mute

- Press [] button to mute H/S microphone, Mute icon [] is on, and press again to return normal.

13. Base Paging

- Press **PAGE** button on base to perform page function.
- The page tone on H/S will continue for 15 sec.
- Page icon [] will flash, "bASE PAGE" message is displayed on LCD.

14. Call Barring

- When a barring number is set by programming, any dialing number start with this no. will be blocked.
- LCD on H/S will show "bArring" message.
- The default barring number is NULL.

15. Battery Low Warning



- During power up, if battery low, H/S doesn't make any operation and LCD shows [] for 10s while then go to sleep (LCD turns off) until the battery is recharged to normal voltage.
- 5 minutes after battery low in standby state, H/S doesn't response to any buttons and LCD turns off until the battery is recharged to normal voltage.

SECTION A

FUNCTION DESCRIPTION

- During conversation, when battery power is lower than a certain level, a short warning beep tone is heard every 2 sec. and the normal operation of the phone will be shut down in 3 minutes.
- Return Handset to cradle to re-charge to stop warning tone.
- **Notice:** If the battery level is too low H/S may not turn on after recharge battery to normal. In this case the battery should be remove and re-plug to H/S to turn H/S on.
- **Notice:** When handset is battery low, press [] key the display will show "Lo bAtt".



16. Battery Level indication

- Battery level icon is shown on LCD.
- When battery level is high, LCD shows [].
- When battery level is low, LCD shows [], a warning tone is heard if H/S in use.
- **Notice:** using a fully discharged battery, the battery level indicator will show good after you placing the handset on charge cradle a moment. It doesn't mean the battery is good, it will drop down rapidly after off cradle. It is recommended that an overnight charging could be performed for a new or discharged battery.

17. Out of Range Warning

- During in conversation, if Handset is far away from base unit, a 2-short alert beep tone will be heard in every 2 sec. to remind the user that the RF linking is at a poor condition.
- If the user do not return to range within 10 sec. the base will disconnect the line automatically.

18. Key Lock

- When key lock is set enable by programming, no key can be press except [] button.
- During ringing, phone key [] can bypass the key-lock function.

**FUNCTION
DESCRIPTION****19. Recall**

- During in phone state, press [**R**] button will break the Line for short time.
- The function is used to access special services offered by Telephone Company.
- Recall time can be selected by programming function according to deferent

20. Awado mode

- The set cannot be used on an automatic change-over switch junction box.

21. Comfort Features in the German Telekom Network

- If the set is used in a PBX environment, you must set the flash time* ("Setting the signal key function") to use the comfort functions of the German Telekom network, such as call waiting indication, brokering, etc.
- *) The flash time is specified in the user manual of your telephone system.

SECTION B

PROGRAMMING PROCEDURE DESCRIPTION

During in programming mode, press the [↵] button to cancel and escape, no any changing will be performed.

1. Key Touch Tone Enable/Disable

Key Entered	Display Shown	Tone Indication
Press [↵]	Pro-	
Press [1]	Pro-tonE @	
Press [1] for toggle on/off	Pro-tonE on/OFF	
Press [→●]		Confirmation tone

Programming icon [↵] flash during the process. @ for current setting, default is on.

2. Ringer Tone Select

Key Entered	Display Shown	Tone Indication
Press [↵]	Pro-	
Press [2]	Pro-ringtonE @	
Enter the ringer selection 1 to 4	Pro-ringtonE X	Corresponding ring
Press [→●]		Confirmation tone

Programming icon [↵] flash during the process. @ for current setting, default is 2, X for digit 1 to 4.

3. Ringer Loudness Select



Key Entered	Display Shown	Tone Indication
Press [↵]	Pro-	
Press [3]	Pro-ring @	
Press [1] to Select the ringer off/Low/high	Pro-ring off/Lo/Hi	
Press [→●]		Confirmation tone

Programming icon [↵] flash during the process. @ for current setting, default ringer is high.

SECTION B



PROGRAMMING PROCEDURE DESCRIPTION

4. Auto Phone On

Key Entered	Display Shown	Tone Indication
Press []	Pro-	
Press [4]	Pro-Auto @	
Press [1] for toggle on/off	Pro-Auto on/off	
Press []		confirmation tone



Programming icon [] flash during the process. @ for current setting, default is off.



5. Emergency call (Baby call)

Key Entered	Display Shown	Tone Indication
Press []	Pro-	
Press [6]	Pro-bAby @	
Press [1] for toggle on/off	Pro-bAby on/off	
Press []		confirmation tone

Memory [0] must be programmed. Programming icon [] flash during the process. @ for current setting, default is off.

6. Key Lock

Key Entered	Display Shown	Tone Indication
Press []	Pro-	
Press [7]	Pro-Hold @	
Press [1] for toggle on/off	Pro-Hold on/off	
Press []		confirmation tone

Programming icon [] and Key-lock setting icon [] flash during the process. @ for current setting, default is off.



After Key-lock is set to on, LCD shows [Hold] message if any key, except  , is pressed.

SECTION B

PROGRAMMING PROCEDURE DESCRIPTION



**) To lift the bar, repeat steps 1 to 4 of the bar procedure. Then press the microphone button, followed by the memory button.*



7. Setting Barring Number for Call Barring

Key Entered	Display Shown	Tone Indication
Press []	Pro-	
Press [8]	EntEr codE	
Press 4-digit PIN	codE —	
PIN entered is correct	bArring @	Happy tone
Enter the 1.. 3-digit barring no. / Press [] erase barring no.	bArring X	
Press []		confirmation tone

Programming icon [] flash during the process. @ for current setting, default is NULL, X for 1..3-digit barring no.

8. Setting tone/pulse dialing (Optional, country dependent)

Key Entered	Display Shown	Tone Indication
Press []	Pro-	
Press [*]	Pro-@ diAL	
Press [1] for toggle tone/pulse	Pro-tonEdiAL/ Pro-PuLSE diAL	
Press []		confirmation tone

Programming icon [] flash during the process. @ for current setting, default is tone. If tone function is set, tone icon [] is shown on LCD. Else [] is off.

9. Reset to default values

Key Entered	Display Shown	Tone Indication
Press []	Pro-	
Press [0]	EntEr codE	
Enter 4-digit PIN	codE —	
If PIN is correct, process continue Else terminate	rESet ? y	Happy tone / Sad tone

SECTION B

PROGRAMMING
PROCEDURE
DESCRIPTION

Press [1] to toggle y/n	rESet ? y/n	
Press [→●]		Confirmation tone

Programming icon [→] flash during the process.

10. Program Personal Identity Number (PIN)

Key Entered	Display Shown	Tone Indication
Press [→]	Pro-	
Press [#]	EntEr codE	
Enter the old 4-digit PIN.	codE —	
If PIN entered is correct, process continue Else terminate	EntEr codE	a happy tone / a sad tone
Enter new 4-digit PIN	codE xxxx	
Press [→●]		confirmation tone

Programming icon [→] flash during the process. xxxx for 4-digit PIN, default is 0000.

11. Extended Redial (PIN)

Key Entered	Display Shown	Tone Indication
Press [→]	Pro-	
Press [☒]	Pro-rEdiAL	
Show redial Tel. no. Modify it if necessary	XXXXXX	
Press [→●]		confirmation tone

Programming icon [→] flash during the process. If extended redial Tel. no. exceed 24 digits, the process will be invalid. XXXXX is telephone number. Extended redial memory content will be cleared after programming reset.

12. Programming Memory

Key Entered	Display Shown	Tone Indication
Press [→]	Pro-	

To delete the memory, repeat steps 1 and 2, then press the microphone button ☒ and then the memory button →●. It is possible to overwrite the memory content with a new number.

SECTION B

Key Entered	Display Shown	Tone Indication
Press [→↵]	SEL LocAtion	
Select memory location 0..9	EntEr no	
Enter Tel. No. : 0..9, #, *, pause	entered digit	
'*' for temp. tone in pulse mode	"r" for recall	
Pressing [☒] for backspace	"P" for pause "u" for "u", "n" for "n"	
Press [→●]		Confirmation tone

Programming icon [→↵] flash during the process. All memory contents will be cleared after programming reset.

13. Selecting Signal [R] (Optional, country)

Key Entered	Display Shown	Tone Indication
Press [→↵]	Pro-	
Press [R]	Pro-r @	
Enter selection 1 to 3	Pro-r 100/260/600	
Press [→●]		Confirmation tone

programming icon [→↵] flash during the process. @ for current setting (1/2/3 for 100ms/260ms/600ms time break).

Note: For some country without this option, it is fixed at 100ms and cannot be changed.

SECTION B

14. Programming Key List

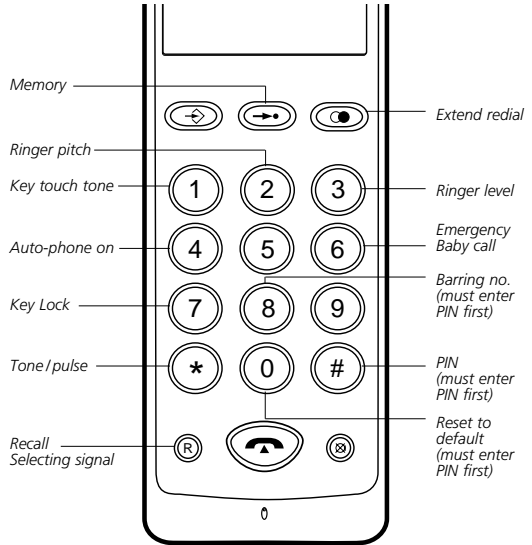

DEFAULT SETTING

Ringer Tone select	pitch 2
Key touch Tone	on
Auto phone on	off
Baby call	off
Key lock	off
Barring number for Call Barring	NULL
Tone/pulse dialing	tone
Personal identity number	0000
Recall time break	100 ms
Memory location 0..9	clear
Extended redial memory	clear

SECTION C

HOW TO EXTEND THE LIFE OF YOUR BATTERY

You can extend the life of the batteries if you follow these tips:

Tip 1: The first charge is critical. Make sure that the battery is fully charged before first use.

Tip 2: Exploit the power of the battery. Use all the power the battery has until it is depleted. This maintains the charge potential of the battery.

Tip 3: Do not charge the battery when it still has power. If you charge the battery too often, the so-called memory effect develops. This means the battery "knows" that not much power is used and will only provide as much power as is needed.

Tip 4: Completely discharge the battery once every week. This is very useful: Fully discharge and then charge the battery.

Tip 5: If the battery has little "stamina", several complete discharges and recharges will help.

Tip 6: Do not overcharge! Make sure to charge the battery for as long as it needs. Frequent overcharging in the quick charger causes early ageing and reduces the battery capacity.

Tip 7: Charge the battery at room temperature. Do not charge the battery when it is cold. This damages the cells.

Tip 8: Store the battery in a cool place. Batteries will lose charge (about 20 % per month) even when not used. If you want to store your battery for a long time, put it in the fridge.

WARRANTY

This product is under warranty for 24 months from the date of purchase. Defects which are obviously due to the material or workmanship will be repaired free of charge during this period. This warranty will not be honoured if the product has been mishandled, e.g., dropped or pushed hard, or tampered with or altered by anyone other than the manufacturer.

If you have a warranty claim, please call the service number on the rear cover page. Please have the following handy:

- 1) a brief description of the difficulties encountered
- 2) proof of purchase.

CE 0681 ①

GARANTIE

Bei Garantie-Inanspruchnahme wenden Sie sich bitte an die unten stehende Telefonnummer.

WARRANTY

If your product is defective, please call the phone number at the bottom of this page.

GARANTIE

Lors de la demande de prestation de garantie, veuillez-vous adresser au numéro de téléphone ci-dessous.

Service in Deutschland:

Hotline 0180 / 532 37 49

Service for Germany:

Hotline 0180 / 532 37 49

Service en Allemagne:

Hotline 0180 / 532 37 49