

N-Channel Enhancement Mode MOSFET

Features

- 20V/40A,
 $R_{DS(ON)} = 12m\Omega$ (typ.) @ $V_{GS} = 4.5V$
 $R_{DS(ON)} = 18m\Omega$ (typ.) @ $V_{GS} = 2.5V$
- Super High Dense Cell Design
- Reliable and Rugged
- Lead Free Available (RoHS Compliant)

Pin Description

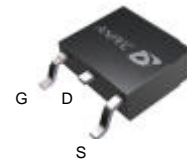

Top View of TO-252

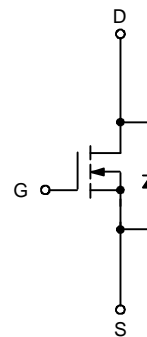



N-Channel MOSFET

Applications

- Power Management in Desktop Computer or DC/DC Converters

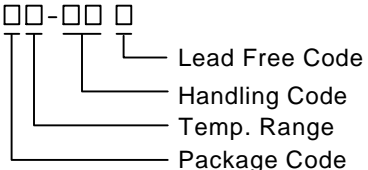
Ordering and Marking Information

<p>APM2014N □□-□□□</p>  <p> □□ - Temp. Range -□□ - Handling Code □ - Lead Free Code </p>	<p>Package Code U : TO-252</p> <p>Operating Junction Temp. Range C : -55 to 150°C</p> <p>Handling Code TU : Tube TR : Tape & Reel</p> <p>Lead Free Code L : Lead Free Device Blank : Original Device</p>
<p>APM2014N U :</p> 	<p>XXXXX - Date Code</p>

Note: ANPEC lead-free products contain molding compounds and 100% matte tin plate termination finish; which are fully compliant with RoHS and compatible with both SnPb and lead-free soldering operations. ANPEC lead-free products meet or exceed the lead-free requirements of IPC/JEDEC J STD-020C for MSL classification at lead-free peak reflow temperature.

ANPEC reserves the right to make changes to improve reliability or manufacturability without notice, and advise customers to obtain the latest version of relevant information to verify before placing orders.

Absolute Maximum Ratings

Symbol	Parameter	Rating	Unit
Common Ratings ($T_A=25^\circ\text{C}$ Unless Otherwise Noted)			
V_{DSS}	Drain-Source Voltage	20	V
V_{GSS}	Gate-Source Voltage	± 16	
T_J	Maximum Junction Temperature	150	$^\circ\text{C}$
T_{STG}	Storage Temperature Range	-55 to 150	$^\circ\text{C}$
I_S	Diode Continuous Forward Current	$T_C=25^\circ\text{C}$ 16	A
Mounted on Large Heat Sink			
I_{DP}	300 μs Pulse Drain Current Tested	$T_C=25^\circ\text{C}$ 100	A
		$T_C=100^\circ\text{C}$ 75	
I_D	Continuous Drain Current	$T_C=25^\circ\text{C}$ 40*	A
		$T_C=100^\circ\text{C}$ 25	
P_D	Maximum Power Dissipation	$T_C=25^\circ\text{C}$ 50	W
		$T_C=100^\circ\text{C}$ 20	
$R_{\theta\text{JC}}$	Thermal Resistance-Junction to Case	2.5	$^\circ\text{C/W}$
Mounted on PCB of 1in² pad area			
I_{DP}	300 μs Pulse Drain Current Tested	$T_A=25^\circ\text{C}$ 100	A
		$T_A=100^\circ\text{C}$ 75	
I_D	Continuous Drain Current	$T_A=25^\circ\text{C}$ 10	A
		$T_A=100^\circ\text{C}$ 6	
P_D	Maximum Power Dissipation	$T_A=25^\circ\text{C}$ 2.5	W
		$T_A=100^\circ\text{C}$ 1	
$R_{\theta\text{JA}}$	Thermal Resistance-Junction to Ambient	50	$^\circ\text{C/W}$
Mounted on PCB of Minimum Footprint			
I_{DP}	300 μs Pulse Drain Current Tested	$T_A=25^\circ\text{C}$ 100	A
		$T_A=100^\circ\text{C}$ 75	
I_D	Continuous Drain Current	$T_A=25^\circ\text{C}$ 9	A
		$T_A=100^\circ\text{C}$ 6	
P_D	Maximum Power Dissipation	$T_A=25^\circ\text{C}$ 1.6	W
		$T_A=100^\circ\text{C}$ 0.6	
$R_{\theta\text{JA}}$	Thermal Resistance-Junction to Ambient	75	$^\circ\text{C/W}$

Note:

* Current limited by bond wire.

Electrical Characteristics (T_A = 25°C unless otherwise noted)

Symbol	Parameter	Test Condition	APM2014NU			Unit
			Min.	Typ.	Max.	
Static Characteristics						
BV _{DSS}	Drain-Source Breakdown Voltage	V _{GS} =0V, I _{DS} =250μA	20			V
I _{DSS}	Zero Gate Voltage Drain Current	V _{DS} =16V, V _{GS} =0V			1	μA
		T _J =85°C			30	
V _{GS(th)}	Gate Threshold Voltage	V _{DS} =V _{GS} , I _{DS} =250μA	0.7	0.9	1.5	V
I _{GSS}	Gate Leakage Current	V _{GS} =±16V, V _{DS} =0V			±100	nA
R _{DS(ON)} ^a	Drain-Source On-state Resistance	V _{GS} =4.5V, I _{DS} =10A		12	14	mΩ
		V _{GS} =2.5V, I _{DS} =5A		18	25	
Diode						
V _{SD} ^a	Diode Forward Voltage	I _{SD} =4A, V _{GS} =0V		0.8	1.3	V
Dynamic Characteristics^b						
R _G	Gate Resistance	V _{GS} =0V, V _{DS} =0V, F=1MHz		1.7		Ω
C _{iss}	Input Capacitance	V _{GS} =0V, V _{DS} =15V, Frequency=1.0MHz		1290		pF
C _{oss}	Output Capacitance			300		
C _{riss}	Reverse Transfer Capacitance			210		
t _{d(ON)}	Turn-on Delay Time	V _{DD} =10V, R _L =10Ω, I _{DS} =1A, V _{GEN} =4.5V, R _G =6Ω		10	20	ns
T _r	Turn-on Rise Time			15	29	
t _{d(OFF)}	Turn-off Delay Time			28	52	
T _f	Turn-off Fall Time			17	33	
t _{rr} ^b	Reverse Recovery Time	I _{SD} =10A, dI _{SD} /dt =100A/μs		20		ns
Q _{rr} ^b	Reverse Recovery Charge			9		nC
Gate Charge Characteristics^b						
Q _g	Total Gate Charge	V _{DS} =10V, V _{GS} =4.5V, I _{DS} =5A		18.2	24	nC
Q _{gs}	Gate-Source Charge			5.6		
Q _{gd}	Gate-Drain Charge			4.8		

Notes:

- a : Pulse test ; pulse width ≤ 300μs, duty cycle ≤ 2%.
- b : Guaranteed by design, not subject to production testing.

Typical Characteristics

Power Dissipation

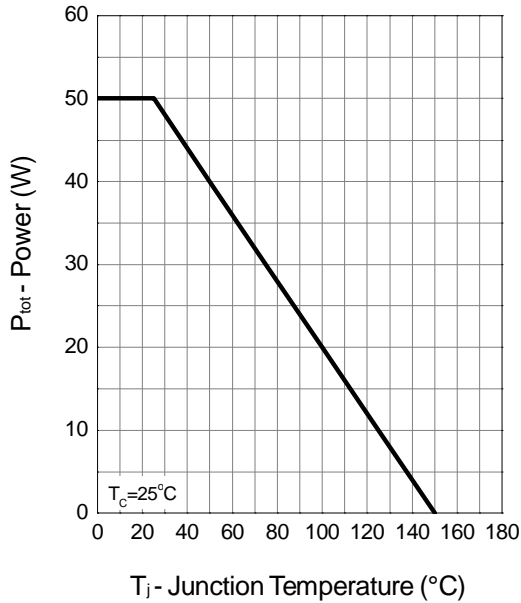

Drain Current

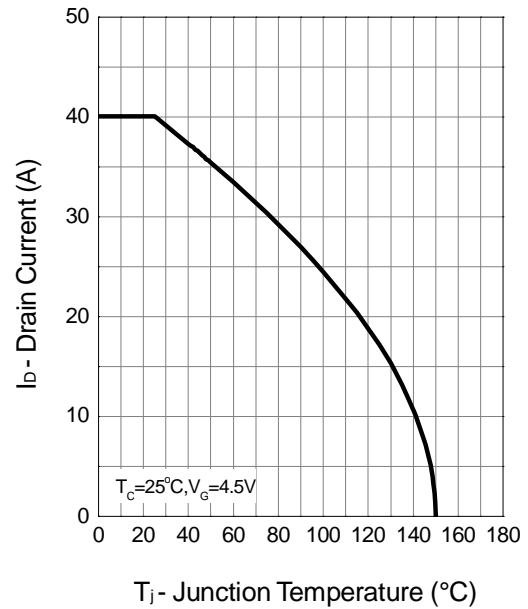

Safe Operation Area

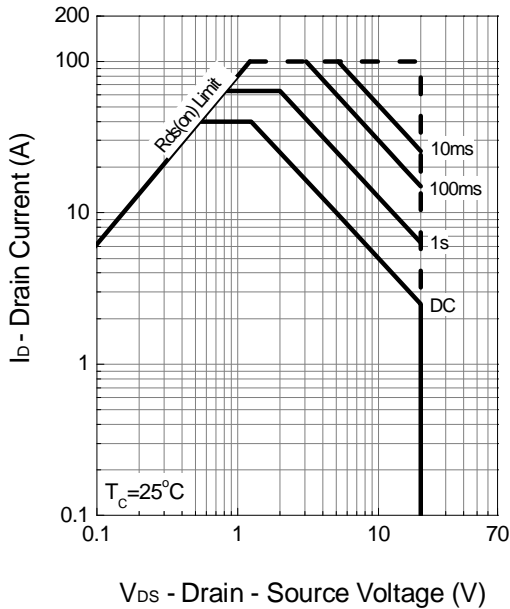

Thermal Transient Impedance

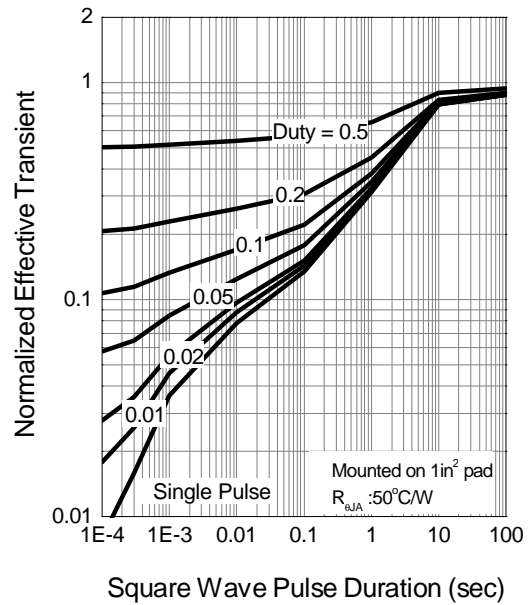

Typical Characteristics (Cont.)

Output Characteristics

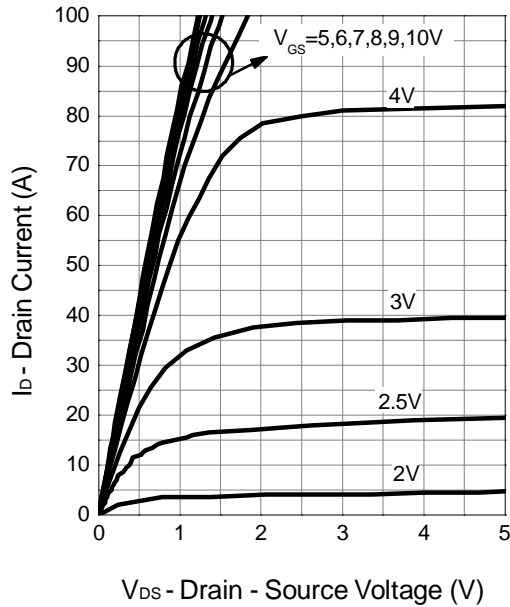

Drain-Source On Resistance

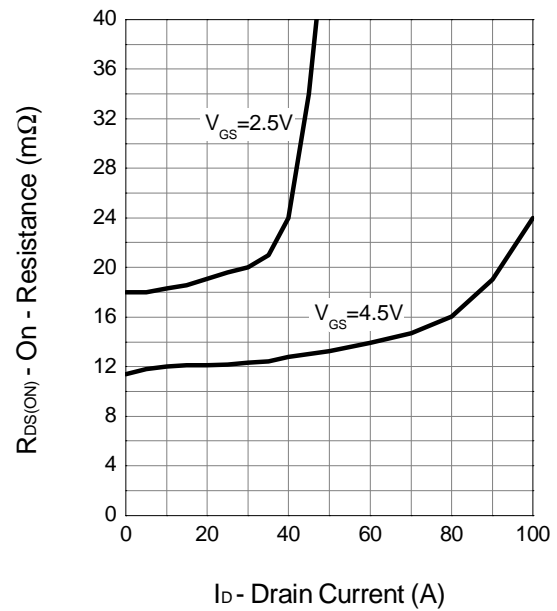

Transfer Characteristics

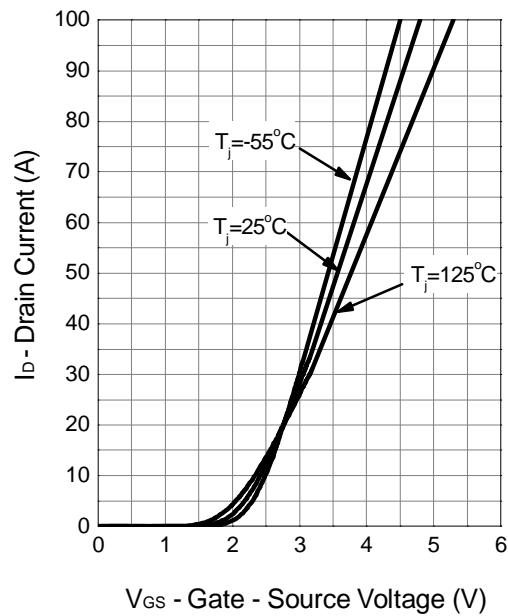

Gate Threshold Voltage

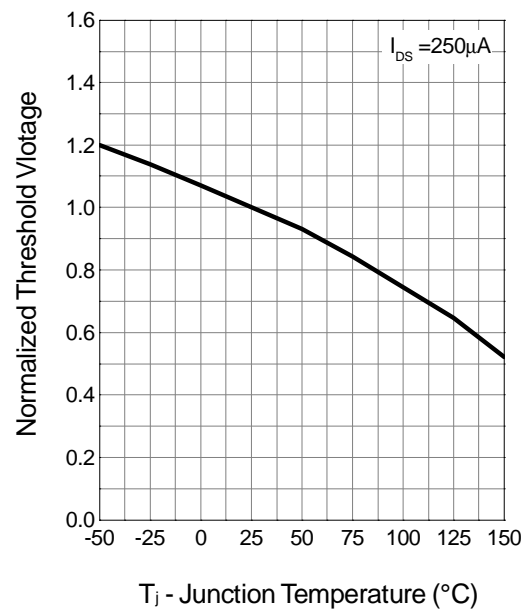

Typical Characteristics (Cont.)

Drain-Source On Resistance

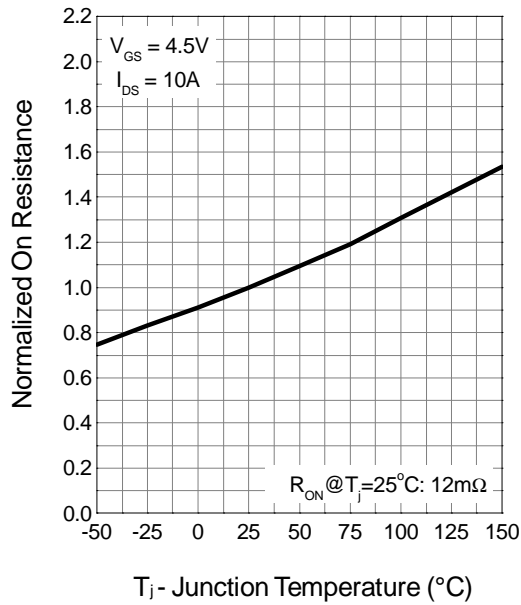

Source-Drain Diode Forward

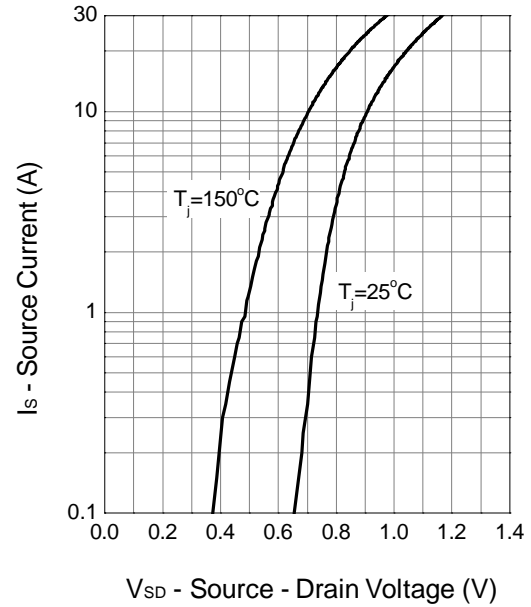

Capacitance

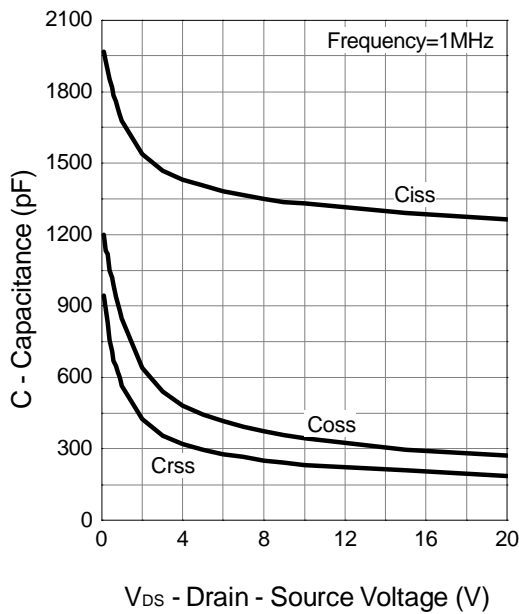

Gate Charge

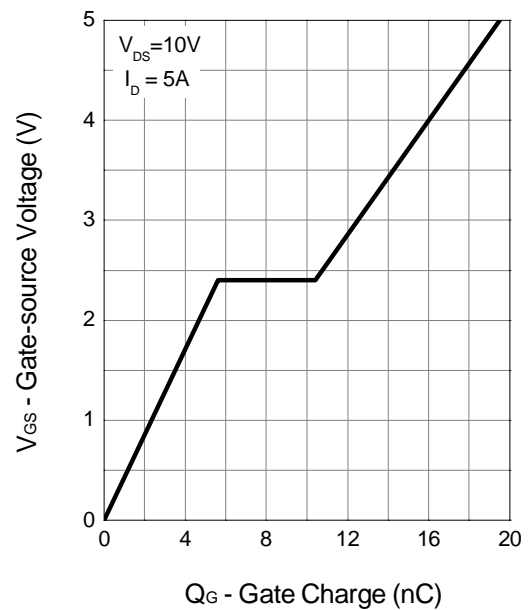

Package Information

TO-252 (Reference JEDEC Registration TO-252)

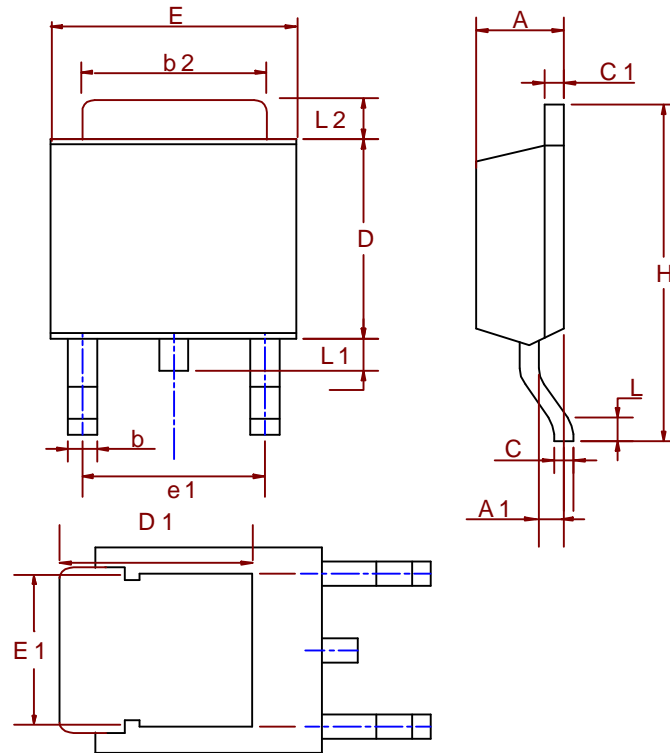

Dim	Millimeters		Inches	
	Min.	Max.	Min.	Max.
A	2.18	2.39	0.086	0.094
A1	0.89	1.27	0.035	0.050
b	0.508	0.89	0.020	0.035
b2	5.207	5.461	0.205	0.215
C	0.46	0.58	0.018	0.023
C1	0.46	0.58	0.018	0.023
D	5.334	6.22	0.210	0.245
D1	5.2 REF		0.205 REF	
E	6.35	6.73	0.250	0.265
E1	5.3 REF		0.209 REF	
e1	3.96	5.18	0.156	0.204
H	9.398	10.41	0.370	0.410
L	0.51		0.020	
L1	0.64	1.02	0.025	0.040
L2	0.89	2.032	0.035	0.080

Physical Specifications

Terminal Material	Solder-Plated Copper (Solder Material : 90/10 or 63/37 SnPb), 100%Sn
Lead Solderability	Meets EIA Specification RSI86-91, ANSI/J-STD-002 Category 3.

Reflow Condition (IR/Convection or VPR Reflow)

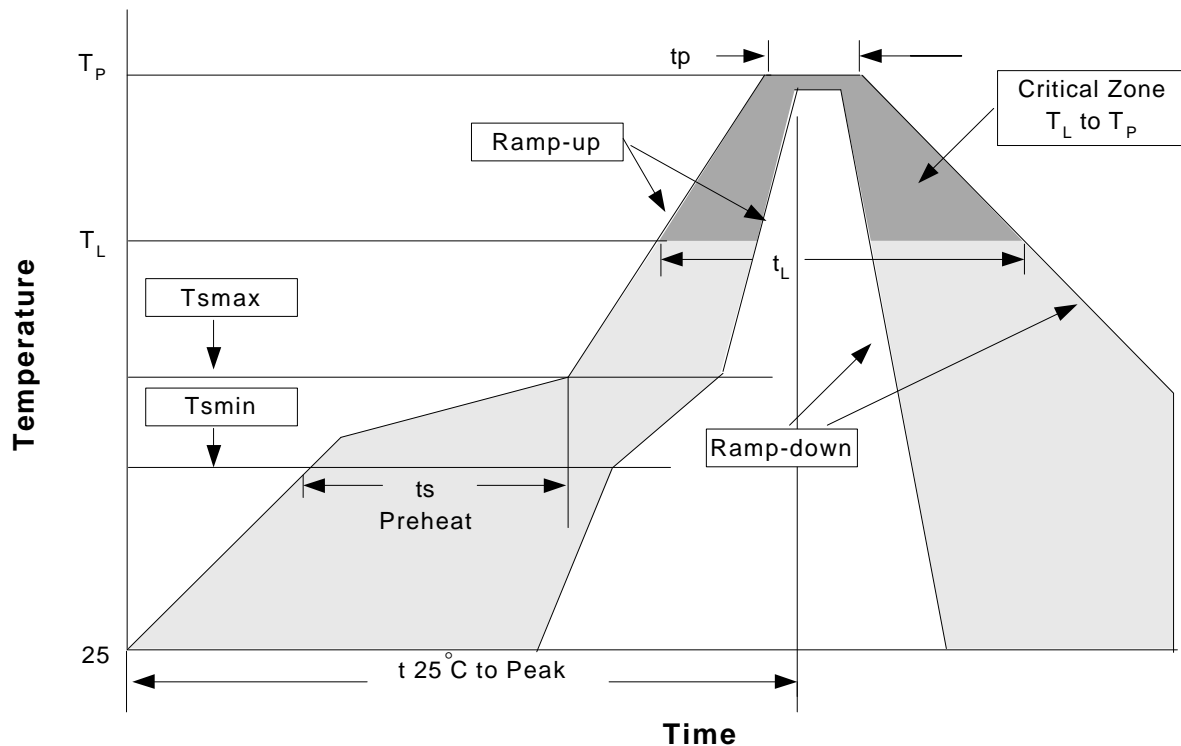

Classification Reflow Profiles

Profile Feature	Sn-Pb Eutectic Assembly	Pb-Free Assembly
Average ramp-up rate (T_L to T_P)	3°C/second max.	3°C/second max.
Preheat		
- Temperature Min (T_{smin})	100°C	150°C
- Temperature Max (T_{smax})	150°C	200°C
- Time (min to max) (t_s)	60-120 seconds	60-180 seconds
Time maintained above:		
- Temperature (T_L)	183°C	217°C
- Time (t_L)	60-150 seconds	60-150 seconds
Peak/Classification Temperature (T_p)	See table 1	See table 2
Time within 5°C of actual Peak Temperature (t_p)	10-30 seconds	20-40 seconds
Ramp-down Rate	6°C/second max.	6°C/second max.
Time 25°C to Peak Temperature	6 minutes max.	8 minutes max.

Notes: All temperatures refer to topside of the package .Measured on the body surface.

Classification Reflow Profiles(Cont.)

Table 1. SnPb Eutectic Process – Package Peak Reflow Temperatures

Package Thickness	Volume mm ³ <350	Volume mm ³ ≥350
<2.5 mm	240 +0/-5°C	225 +0/-5°C
≥2.5 mm	225 +0/-5°C	225 +0/-5°C

Table 2. Pb-free Process – Package Classification Reflow Temperatures

Package Thickness	Volume mm ³ <350	Volume mm ³ 350-2000	Volume mm ³ >2000
<1.6 mm	260 +0°C*	260 +0°C*	260 +0°C*
1.6 mm – 2.5 mm	260 +0°C*	250 +0°C*	245 +0°C*
≥2.5 mm	250 +0°C*	245 +0°C*	245 +0°C*

*Tolerance: The device manufacturer/supplier **shall** assure process compatibility up to and including the stated classification temperature (this means Peak reflow temperature +0°C. For example 260°C+0°C) at the rated MSL level.

Reliability Test Program

Test item	Method	Description
SOLDERABILITY	MIL-STD-883D-2003	245°C, 5 SEC
HOLT	MIL-STD 883D-1005.7	1000 Hrs Bias @ 125°C
PCT	JESD-22-B, A102	168 Hrs, 100% RH, 121°C
TST	MIL-STD 883D-1011.9	-65°C ~ 150°C, 200 Cycles

Carrier Tape & Reel Dimensions

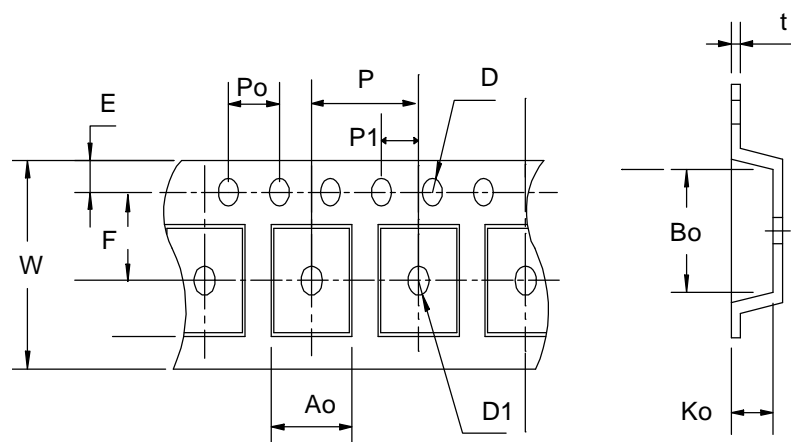

Carrier Tape & Reel Dimensions (Cont.)

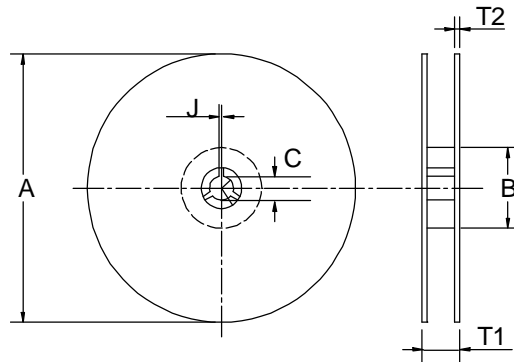

Application	A	B	C	J	T1	T2	W	P	E
TO-252	330 ±3	100 ±2	13 ±0.5	2 ±0.5	16.4 +0.3 -0.2	2.5 ±0.5	16+ 0.3 -0.1	8 ±0.1	1.75 ±0.1
	F	D	D1	Po	P1	Ao	Bo	Ko	t
	7.5 ±0.1	1.5 +0.1	1.5 ±0.25	4.0 ±0.1	2.0 ±0.1	6.8 ±0.1	10.4 ±0.1	2.5 ±0.1	0.3 ±0.05

(mm)

Cover Tape Dimensions

Application	Carrier Width	Cover Tape Width	Devices Per Reel
TO-252	16	13.3	2500

Customer Service

Anpec Electronics Corp.

Head Office :

No.6, Dusing 1st Road, SBIP,

Hsin-Chu, Taiwan, R.O.C.

Tel : 886-3-5642000

Fax : 886-3-5642050

Taipei Branch :

7F, No. 137, Lane 235, Pac Chiao Rd.,

Hsin Tien City, Taipei Hsien, Taiwan, R. O. C.

Tel : 886-2-89191368

Fax : 886-2-89191369