

SPEC No.	E L 0 7 Y 0 0 5
ISSUE:	Nov. 6. 1995

To: _____

REQUEST FOR
CONFIRMATION

S P E C I F I C A T I O N S

Product Type Drive IC (190K/220K pixels single voltage B/W CCD)

Model No. L Z 9 G G 3 2 M

※This specifications contains 30 pages including the cover and appendix.
If you have any objections, please contact us before issuing purchasing order.

CUSTOMERS ACCEPTANCE

DATE: _____

BY: _____

PRESENTED

BY: X. Kusano
X. KUSANO
Dept. General Manager

REVIEWED BY:

PREPARED BY:

A. Tokino H. Yoshizawa

Engineering Dept. 3
Logic IC Engineering Center
Tenri Integrated Circuits Group
SHARP CORPORATION

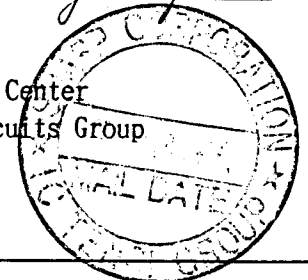

- Handle this document carefully for it contains material protected by international copyright law. Any reproduction, full or in part, of this material is prohibited without the express written permission of the company.
- When using the products covered herein, please observe the conditions written herein and the precautions outlined in the following paragraphs. In no event shall the company be liable for any damages resulting from failure to strictly adhere to these conditions and precautions.
 - (1) The products covered herein are designed and manufactured for the following application areas. When using the products covered herein for the equipment listed in Paragraph (2), even for the following application areas, be sure to observe the precautions given in Paragraph (2). Never use the products for the equipment listed in Paragraph (3).
 - Office electronics
 - Instrumentation and measuring equipment
 - Machine tools
 - Audiovisual equipment
 - Home appliances
 - Communication equipment other than for trunk lines
 - (2) Those contemplating using the products covered herein for the following equipment which demands high reliability, should first contact a sales representative of the company and then accept responsibility for incorporating into the design fail-safe operation, redundancy, and other appropriate measures for ensuring reliability and safety of the equipment and the overall system.
 - Control and safety devices for airplanes, trains, automobiles, and other transportation equipment
 - Mainframe computers
 - Traffic control systems
 - Gas leak detectors and automatic cutoff devices
 - Rescue and security equipment
 - Other safety devices and safety equipment, etc.
 - (3) Do not use the products covered herein for the following equipment which demands extremely high performance in terms of functionality, reliability, or accuracy.
 - Aerospace equipment
 - Communications equipment for trunk lines
 - Control equipment for the nuclear power industry
 - Medical equipment related to life support, etc.
 - (4) Please direct all queries and comments regarding the interpretation of the above three Paragraphs to a sales representative of the company.
- Please direct all queries regarding the products covered herein to a sales representative of the company.

CONTENTS

1. General	P. 2
1-1. Features		
1-2. Functions		
2. Pin Assignment	P. 3
3. Block Diagram	P. 4
4. Pin Description	P. 5
5. Electrical Characteristics	P. 11
5-1. Absolute Maximum Ratings		
5-2. DC Characteristics		
6. Pulse Timing	P. 12
7. Package Outline	P. 25

1. General

The LZ9GG32M is a CMOS gate array LSI. It generates timing pulses for driving a CCD area sensor, and synchronous pulses for TV signals and processing pulses for video signals.

1-1. Features

- * The package material is plastic.
- * A p-type silicon circuit board is used.
- * The package type is 48-pin QFP (0.5mm pin-pitch)
- * The process (structure) is CMOS.
- * The delay time per 1 gate is 0.9ns.
- * Not designed or rated as radiation hardened.

1-2. Functions

- * Designed for single +5V power supply CCD monochrome area sensor with 190,000 or 220,000 pixels on 1/5 inch size.
- * Switchable between EIA and CCIR mode.
- * Single +5V power supply.
- * Electronic shutter or EE control is possible.

2. Pin Assignment



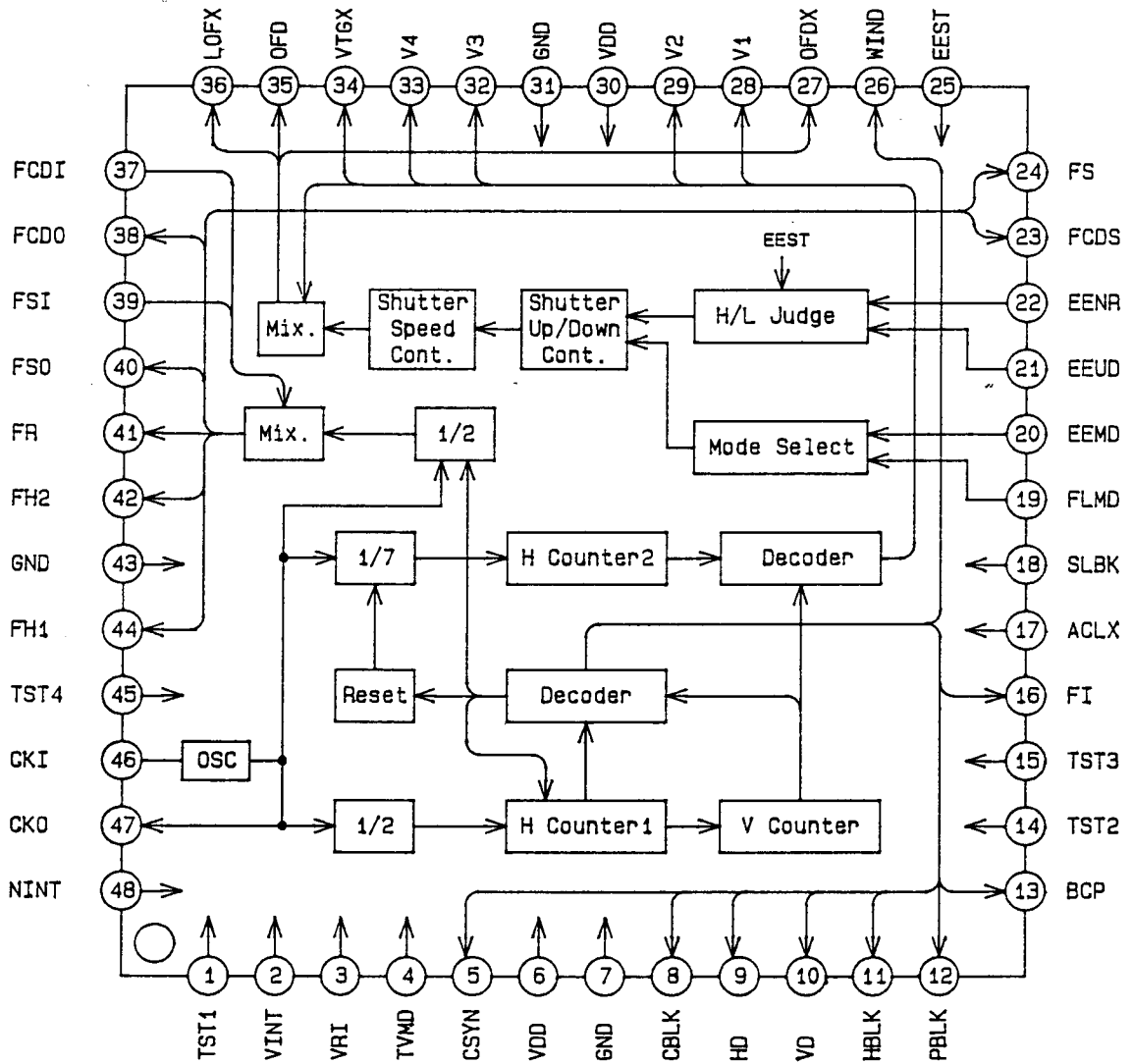

PIN NO.	I/O	SIGNAL	PIN NO.	I/O	SIGNAL
1	ICD	TST1	25	ICU	EEST
2	ICSU	VINT	26	O	WIND
3	ICSU	VR I	27	O	OFDX
4	ICU	TVMD	28	O6MA2	V 1
5	O	CSYN	29	O6MA2	V 2
6	-	V D D	30	-	V D D
7	-	G N D	31	-	G N D
8	O	CBLK	32	O6MA2	V 3
9	O	H D	33	O6MA2	V 4
10	O	V D	34	O6MA	VTGX
11	O	HBLK	35	O6MA	O F D
12	O	PBLK	36	O6MA	LOFX
13	O	B C P	37	IC	FCDI
14	ICD	TST2	38	O6MA2	FCDO
15	ICD	TST3	39	IC	F S I
16	O	F I	40	O6MA2	F S O
17	ICU	ACLX	41	O6MA3	F R
18	ICU	SLBK	42	O6MA3	F H 2
19	ICU	FLMD	43	-	G N D
20	ICU	EEMD	44	O6MA3	F H 1
21	IC	EEUD	45	ICD	TST4
22	IC	EENR	46	OSCI	CKI
23	O6MA2	FCDS	47	OSCO	CKO
24	O6MA2	F S	48	ICU	NINT

IC : Input (CMOS level)
 ICU : Input (CMOS level with pull-up resistor)
 IC SU : Schmitt-trigger Input (CMOS level with pull-up resistor)
 ICD : Input (CMOS level with pull-down resistor)
 O : Output
 O6MA : Output
 O6MA2 : Output
 O6MA3 : Output
 OSCI : Input pin for oscillation
 OSCO : Output pin for oscillation

3. Block Diagram















4. Pin Description



No.	Symbol	I/O	Pol.	Pin Name	Description
1	TST1	ICD	-	Test terminal 1	A test pin. Set open or to L level in the normal mode.
2	VINT	ICSU	-	Initialize input	An input pin for initializing circuit. It can be used Field-reset input, and the circuit is initialized with the 1/2 dividing pulse of VINT. The frequency of VINT is 60Hz in EIA or 50Hz in CCIR. It may be occurred jitter because of catching VINT pulse with the 1/2 dividing pulse of CKI(pin 46). The point of resetting is following, the trailing edge of VINT is advanced, at EIA mode, 0~148ns from the start of ODD field at CCIR mode, 0~148ns from the start of 1st field Set open or H level when internal sync. mode or no intilizing.
3	VRI	ICSU	-	Vertical reset input	An input pin for resetting internal Ver. counter. The input pulse ic necessary 1/2 Hor. max delay from ver. sync. start point, because VRI is counted 2 times Hor. frequency. The point of resetting is following, at EIA mode, 3.5H from the start of VD, at CCIR mode, 3H from the start of VD. Set open or H level when internal sync. or using VINT(pin 2).
4	TVMD	ICU	-	TV mode select	An input pin to select TV standards. L level ; EIA mode H level or open ; CCIR mode
5	CSYN	0		Composite synchronizing pulse	Composite sync. signal output pin.
6	VDD	-	-	Power supply	Supply +5 V power.
7	GND	-	-	Ground	A grounding pin.
8	CBLK	0		Composite blanking pulse	Composite blanking pulse. When SLBK(pin 18) is L level, at EIA mode ; H:10.52ns, V:20H period, at CCIR mode ; H:11.26ns, V:25H period. When SLBK(pin 18) is H level, at EIA mode ; H:10.81ns, V:20H period, at CCIR mode ; H:12.15ns, V:25H period.
9	HD	0		Hor. drive pulse	The pulse occurs at the start of lines.
10	VD	0		Ver. drive pulse	The pulse occurs at the start of every fields.

No.	Symbol	I/O	Pol.	Pin Name	Description																								
11	HBLK	0		Hor. blanking pulse	A pulse that correspondes to the cease period of the Hor. transfer pulse.																								
12	PBLK	0		Pre-blanking pulse	Equivalent to CBLK(pin 8) pulse except for shorter pulse width with cut-off trailing edge.																								
13	BCP	0		Optical black clamp pulse	A pulse to clamp the optical black signal. This pulse stays low during the absence of effective pixels within the ver. blanking.																								
14	TST2	ICD	-	Test terminal 2	A test pin. Set open or to L level in the normal mode.																								
15	TST3	ICD	-	Test terminal 3	A test pin. Set open or to L level in the normal mode.																								
16	FI	0		Field index	The pulse is used for detecting field. at EIA mode ; ODD field : LOW EVEN field : HIGH at CCIR mode ; 1st and 3rd fields : LOW 2nd and 4th fields : HIGH																								
17	ACLX	ICU	-	All clear input	An input pin for resetting all internal circuit.																								
18	SLBK	ICU	-	CBLK width select	An input pin to select the Hor. period of CBLK. L level; at EIA mode ; H:10.52ns, V:20H period at CCIR mode ; H:11.26ns, V:25H period H level; at EIA mode ; H:10.81ns, V:20H period or open at CCIR mode ; H:12.15ns, V:25H period at power on.																								
19	FLMD	ICU	-	Flickerless select	An input pin to select Flickerless shutter mode, with using EEMD(pin 20).																								
20	EEMD	ICU	-	Electronic Exposure select	An input pin to select Electronic Exposure mode, with using FLMD(pin 19). <table border="1" style="margin-left: 20px;"> <thead> <tr> <th>FLMD</th> <th>EEMD</th> <th colspan="2">Shutter speed(s)</th> </tr> <tr> <td></td> <td></td> <th>EIA</th> <th>CCIR</th> </tr> </thead> <tbody> <tr> <td>L</td> <td>L</td> <td>1/60</td> <td>1/50</td> </tr> <tr> <td>H</td> <td>L</td> <td>1/100</td> <td>1/120</td> </tr> <tr> <td>L</td> <td>H</td> <td>1/31, 320max</td> <td>1/30, 890max</td> </tr> <tr> <td>H</td> <td>H</td> <td>1/109, 890max</td> <td>1/109, 890max</td> </tr> </tbody> </table>	FLMD	EEMD	Shutter speed(s)				EIA	CCIR	L	L	1/60	1/50	H	L	1/100	1/120	L	H	1/31, 320max	1/30, 890max	H	H	1/109, 890max	1/109, 890max
FLMD	EEMD	Shutter speed(s)																											
		EIA	CCIR																										
L	L	1/60	1/50																										
H	L	1/100	1/120																										
L	H	1/31, 320max	1/30, 890max																										
H	H	1/109, 890max	1/109, 890max																										
21	EEUD	IC	-	Electronic Exposure control 1	An input pin to control Electronic Exposure, with using EENR(pin 22).																								
22	EENR	IC	-	Electronic Exposure control 2	An input pin to control Electronic Exposure, with using EEUD(pin 21).																								
23	FCDS	06MA2		CDS pulse 1	A pulse to clamp the feed-through level from CCD.																								
24	FS	06MA2		CDS pulse 2	A pulse to sample-hold the signal from CCD.																								
25	EEST	ICU	-	Electronic Exposure control 3	An input pin to control Electronic Exposure, with using EEUD(pin 21) and EENR(pin 22). L level : Electronic Exposure is stopped. H level or open : Electronic Exposure is operated																								

LZ9GG32M

No.	Symbol	I/O	Pol.	Pin Name	Description
26	WIND	0		Wind pulse	A pulse for wind pulse. When connected to EEST(pin 38), the operation of Electronic Exposure can be stopped at the upper side of monitor.
27	OFDX	06MA		Inverse OFD PULSE output	A pulse that is used for pulse additional circuit of electronic shutter.
28	V1	06MA2		Ver. transfer pulse 1	A vertical transfer pulse for CCD. Connect to ϕ V1 pin of CCD.
29	V2	06MA2		Ver. transfer pulse 2	A vertical transfer pulse for CCD. Connect to ϕ V2 pin of CCD.
30	VDD	-	-	Power supply	Supply +5 V power.
31	GND	-	-	Ground	A grounding pin.
32	V3	06MA2		Ver. transfer pulse 3	A vertical transfer pulse for CCD. Connect to ϕ V3 pin of CCD.
33	V4	06MA2		Ver. transfer pulse 4	A vertical transfer pulse for CCD. Connect to ϕ V4 pin of CCD.
34	VTGX	06MA		Read out pulse	A pulse that transfers the charge of the photodiode to the vertical shift resistor. Connect to ϕ TG pin of CCD.
35	OFD	06MA		OFD pulse output	A pulse that sweeps the charge of the photodiode for electronic shutter. Connect to OFD pin of CCD through the D.C. offset circuit.
36	LOFX	06MA		LOFX pulse output	A last pulse that sweeps the charge of the photodiode for electronic shutter. Connect to LOFX pin of CCD.
37	FCDI	IC	-	FCDS phase control input	Pins to control the phase between FH1(pin 44) and FCDS(pin 23).
38	FCDO	06MA2	-	FCDS phase control output	A pulse to control pulse timing of FCDS, connect to FCDI(pin 37) pin through the CR delay circuit.
39	FSI	IC	-	FS phase control input	Pins to control the phase between FH1(pin 44) and FS(pin 24).
40	FSO	06MA2	-	FS phase control output	A pulse to control pulse timing of fs, connect to FSI(pin 39) pin through the CR delay circuit.
41	FR	06MA2		Reset pulse	A reset pulse for CCD. Connect to ϕ RS of CCD through the D.C. offset circuit.
42	FH2	06MA3		Hor. transfer pulse 2	A horizontal transfer pulse for CCD. Connect to ϕ H2 of CCD.
43	GND	-	-	Ground	A grounding pin.
44	FH1	06MA3		Hor. transfer pulse 1	A horizontal transfer pulse for CCD. Connect to ϕ H1 of CCD.
45	TST4	ICD	-	Test terminal 4	A test pin. Set open or to L level in the normal mode.

LZ9GG32M

No.	Symbol	I/O	Pol.	Pin Name	Description
46	CKI	OSCI		Clock input	An input pin for reference clock oscillation. The frequencies are as follows : at EIA mode : 13.500MHz (858fH) at CCIR mode : 13.500MHz (864fH) fH=Hor. frequency
47	CKO	OSCO		Clock output	An output pin for reference clock oscillation. The output is the inverse CKI(pin 46).
48	NINT	ICU	-	Non-interlace select	An input pin to select non-interlace mode. L level : Interlace mode H level or open : Non-interlace mode At non-interlace mode, the field is ODD field and 262H period at EIA mode, and 1st field and 312H period at CCIR mode.

4-2. How to use ACLX pin.

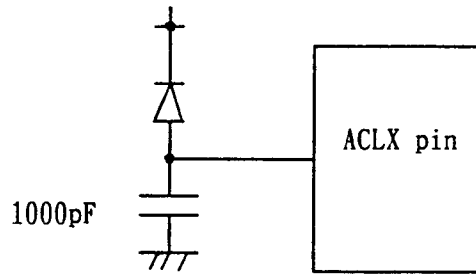

4-3. Fixed shutter mode

E E M D (pin 20)	F L M D (pin 19)	Shutter speed (s)	
		E I A	C C I R
L	L	appro. 1/ 60	appro. 1/ 50
L	H	appro. 1/ 100	appro. 1/ 120

4-4. Electronic Exposur control

E E M D (pin 20)	F L M D (pin 19)	Start shutter speed (s)	
		E I A	C C I R
H	L	1/ 31, 320max	1/ 30, 890max
H	H	1/109, 890max	1/109, 890max

E E M D (pin 20)	E E S T (pin 25)	E E U D (pin 21)	E E N R (pin 22)	Electronic Exposur control
H	H	H	L	Shutter speed up
H	H	H	H	Control stopped
H	H	L	H	Shutter speed down
H	L	×	×	Control stopped

4-5. Shutter speed changes at Electronic Exposure control.

E I A			C C I R		
	Charge time	Shutter speed		Charge time	Shutter speed
0	262H, 263H	$\approx 1/60$ s	0	322H, 323H	$\approx 1/50$ s
1	252H+0.209H	$\approx 1/62$ s	1	302H+0.207H	$\approx 1/52$ s
	(by 10H step)			(by 10H step)	
18	82H+0.209H	$\approx 1/191$ s	23	82H+0.207H	$\approx 1/190$ s
19	72H+0.209H	$\approx 1/218$ s	24	72H+0.207H	$\approx 1/216$ s
20	68H+0.209H	$\approx 1/231$ s	25	68H+0.207H	$\approx 1/230$ s
	(by 4H step)			(by 4H step)	
29	32H+0.209H	$\approx 1/490$ s	34	32H+0.207H	$\approx 1/485$ s
30	28H+0.209H	$\approx 1/560$ s	35	28H+0.207H	$\approx 1/555$ s
31	26H+0.209H	$\approx 1/600$ s	36	26H+0.207H	$\approx 1/595$ s
	(by 2H step)			(by 2H step)	
36	16H+0.209H	$\approx 1/970$ s	41	16H+0.207H	$\approx 1/965$ s
37	14H+0.209H	$\approx 1/1,110$ s	42	14H+0.207H	$\approx 1/1,100$ s
38	13H+0.209H	$\approx 1/1,190$ s	43	13H+0.207H	$\approx 1/1,180$ s
	(by 1H step)			(by 1H step)	
43	8H+0.209H	$\approx 1/1,920$ s	48	8H+0.207H	$\approx 1/1,900$ s
44	7H+0.209H	$\approx 1/2,180$ s	49	7H+0.207H	$\approx 1/2,170$ s
45	6.5H+0.209H	$\approx 1/2,350$ s	50	6.5H+0.207H	$\approx 1/2,335$ s
	(by 0.500H step)			(by 0.500H step)	
49	4.5H+0.209H	$\approx 1/3,360$ s	54	4.5H+0.207H	$\approx 1/3,330$ s
50	4H+0.209H	$\approx 1/3,740$ s	55	4H+0.207H	$\approx 1/3,715$ s
51	3.75H+0.209H	$\approx 1/3,980$ s	56	3.75H+0.207H	$\approx 1/3,960$ s
	(by 0.250H step)			(BY 0.250H step)	
61	1.25H+0.209H	$\approx 1/11,040$ s	66	1.25H+0.207H	$\approx 1/10,930$ s
62	1H+0.209H	$\approx 1/13,020$ s	67	1H+0.207H	$\approx 1/12,945$ s
63	0.875H+0.209H	$\approx 1/14,600$ s	68	0.875H+0.207H	$\approx 1/14,500$ s
	(by 0.125H step)			(by 0.125H step)	
69	0.294H	$\approx 1/53,360$ s	69	0.300H	$\approx 1/52,120$ s
70	0.209H	$\approx 1/75,420$ s	75	0.207H	$\approx 1/75,420$ s
71	0.151H	$\approx 1/103,850$ s	76	0.150H	$\approx 1/103,850$ s

5. Electorical Characteristics

5-1. Absolute Maximum Ratings

Parameter	Symbol	Rating	Unit
Supply voltage	V_{DD}	-0.3 ~ 6.0	V
Input voltage	V_I	-0.3 ~ $V_{DD} + 0.3$	V
Output voltage	V_O	-0.3 ~ $V_{DD} + 0.3$	V
Operation temperature	T_{OPR}	-20 ~ +70	°C
Storage tempetature	T_{STG}	-55 ~ +150	°C

5-2. DC Characteristics ($V_{DD}=+5V\pm 10\%$, $T_{OPR}=-20\sim+70^\circ\text{C}$)

Parameter	Symbol	Condition	MIN.	TYP.	MAX.	Unit	Note
Input "Low" voltage	V_{IL}				1.5	V	1
Input "High" voltage	V_{IH}		3.5			V	
Input "High"	V_{T+}				3.7	V	2
Input "Low"	V_{T-}		1.0			V	
Hysterisis voltage	$V_{T+}-V_{T-}$		0.2			V	
Input "Low" current	$ I_{IL1} $	$V_I = 0\text{ V}$			1.0	μA	3
	$ I_{IL2} $	$V_I = 0\text{ V}$	8.0		75	μA	2,4
Input "High" current	$ I_{IH1} $	$V_I = V_{DD}$			1.0	μA	2,5
	$ I_{IH2} $	$V_I = V_{DD}$	8.0		75	μA	6
Output "High" voltage	V_{OH1}	$I_{OH} = -2\text{mA}$	4.0			V	7
Output "Low" voltage	V_{OL1}	$I_{OL} = 4\text{mA}$			0.4	V	
Output "High" voltage	V_{OH2}	$I_{OH} = -3\text{mA}$	4.0			V	8
Output "Low" voltage	V_{OL2}	$I_{OL} = 4\text{mA}$			0.4	V	
Output "High" voltage	V_{OH2}	$I_{OH} = -6\text{mA}$	4.0			V	9
Output "Low" voltage	V_{OL2}	$I_{OL} = 8\text{mA}$			0.4	V	
Output "High" voltage	V_{OH3}	$I_{OH} = -9\text{mA}$	4.0			V	10
Output "Low" voltage	V_{OL3}	$I_{OL} = 12\text{mA}$			0.4	V	

Note 1 : Applied to Inputs(IC, ICD, ICU, OSC1).

Note 2 : Applied to Inputs(ICSU).

Note 3 : Applied to Inputs(IC, ICD, OSC1).

Note 4 : Applied to Input(ICU).

Note 5 : Applied to Inputs(IC, ICU, OSC1).

Note 6 : Applied to Input(ICD).

Note 7 : Applied to (O, OSC0).

(Output(OSC0) measures on conditions that input(OSC1) level is 0V or V_{DD} .)

Note 8 : Applied to Output(O6MA).

Note 9 : Applied to Output(O6MA2).

Note 10 : Applied to Output(O6MA3).

6. Pulse Timing

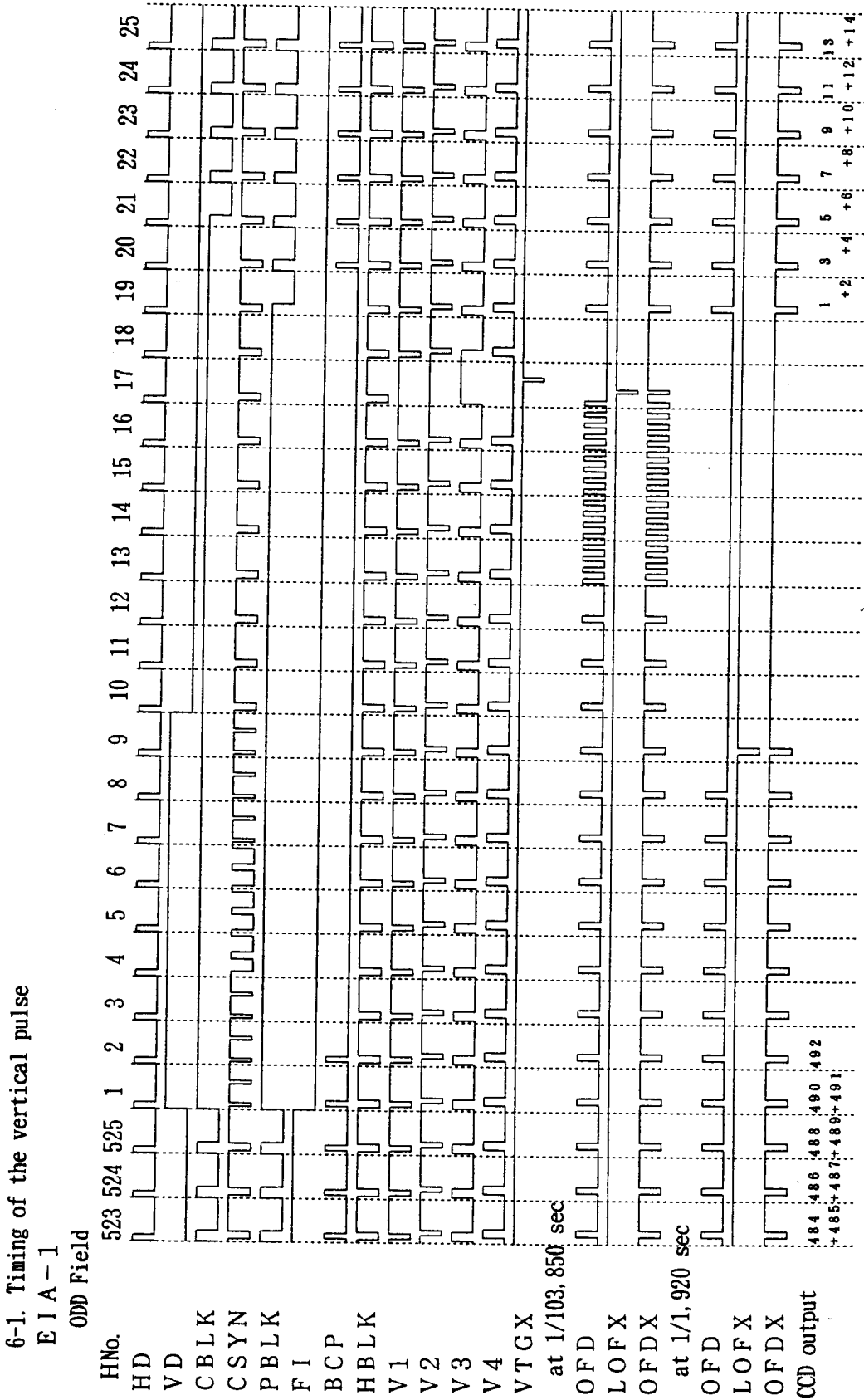

E I A - 2

EVEN Field

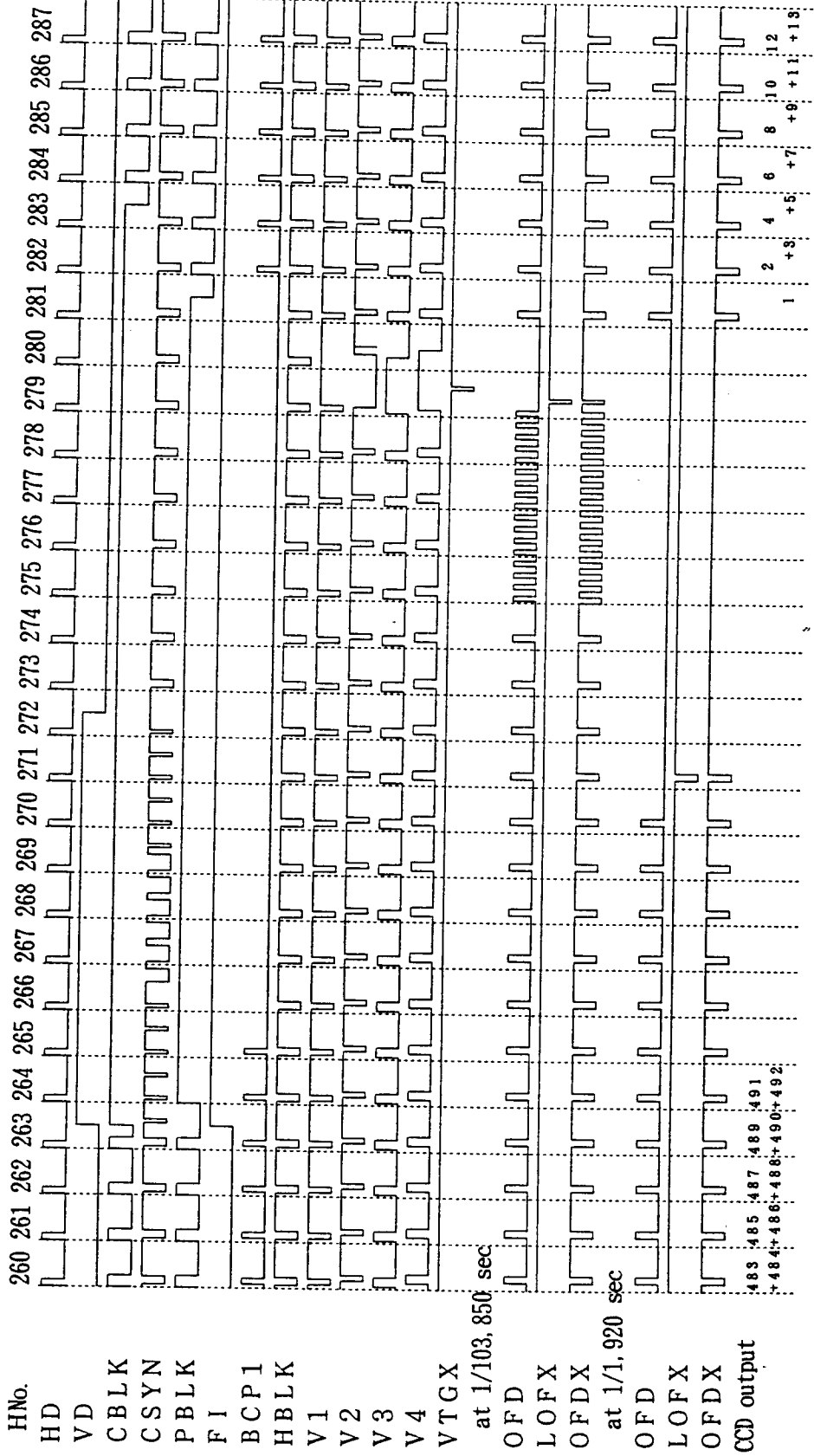

483:485-487 489:491
+484:+486:+488:+490:+492:

CCIR-1 1,3 Field

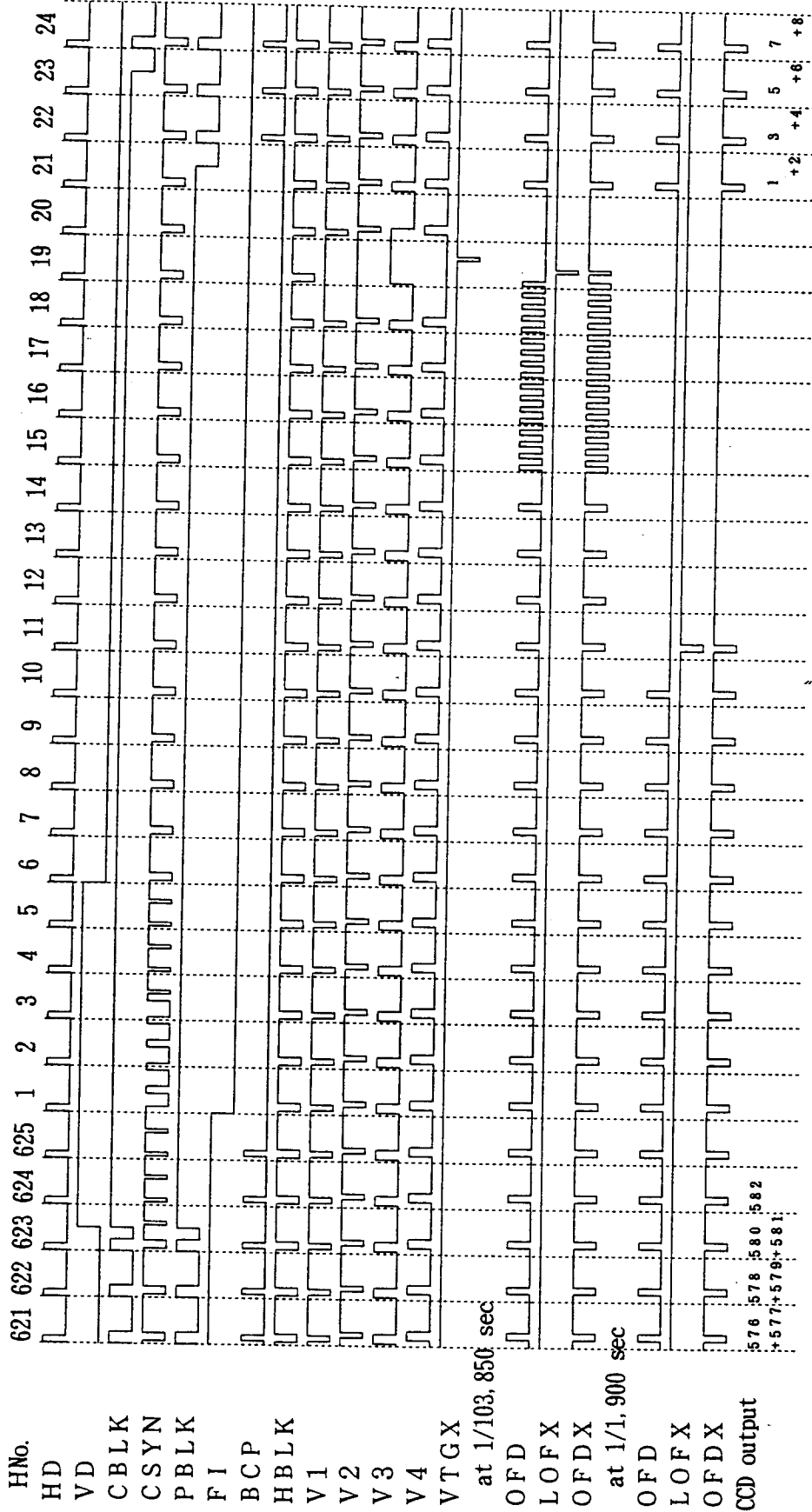

CCIR-2
2,4 Field

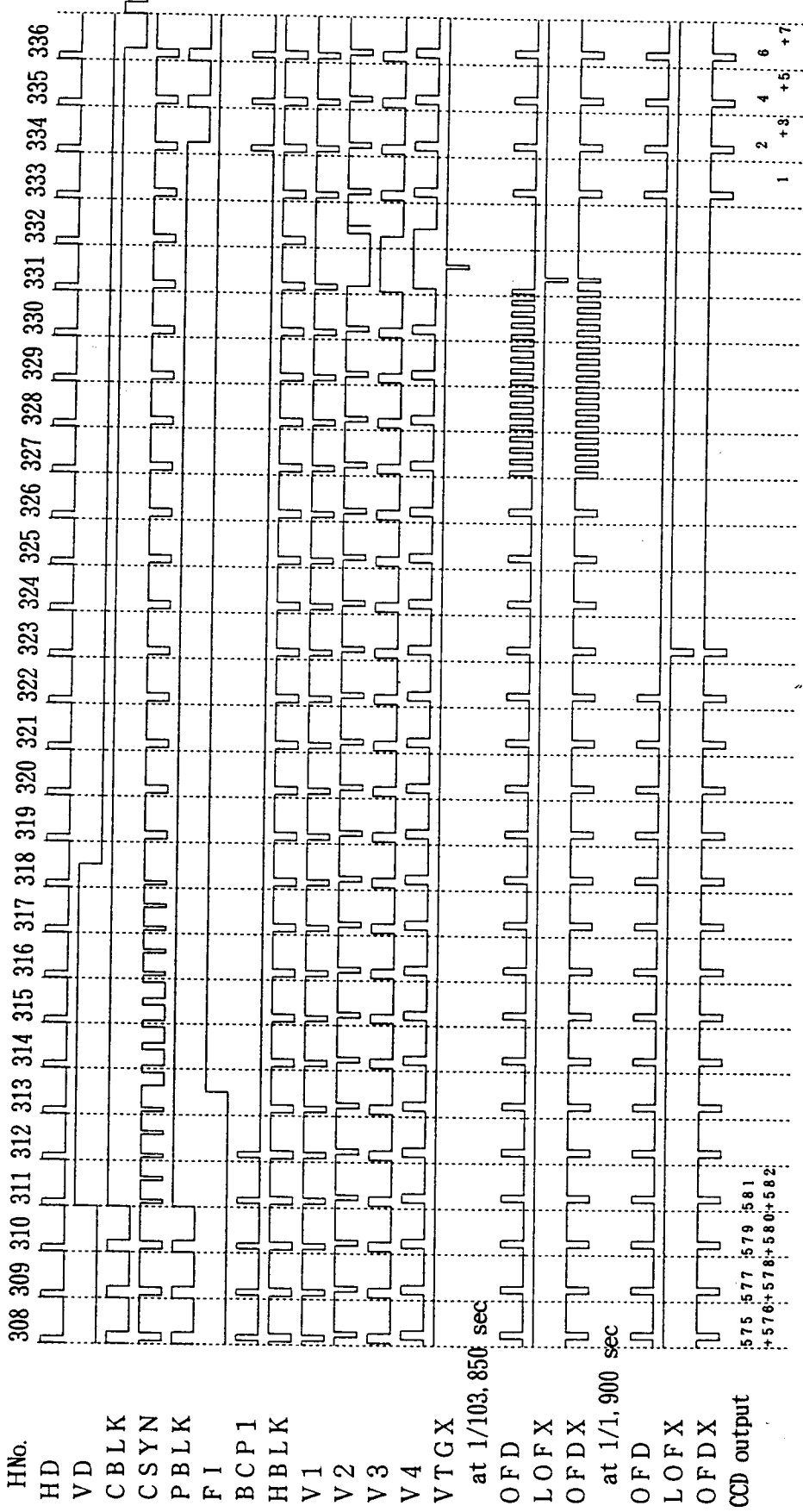

6-2. WIND pulse

E I A

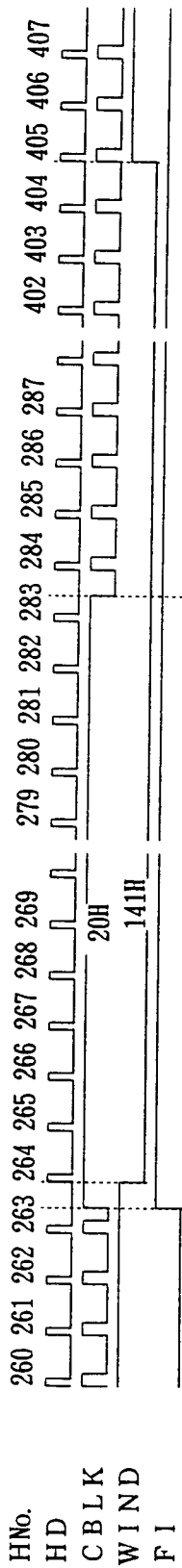
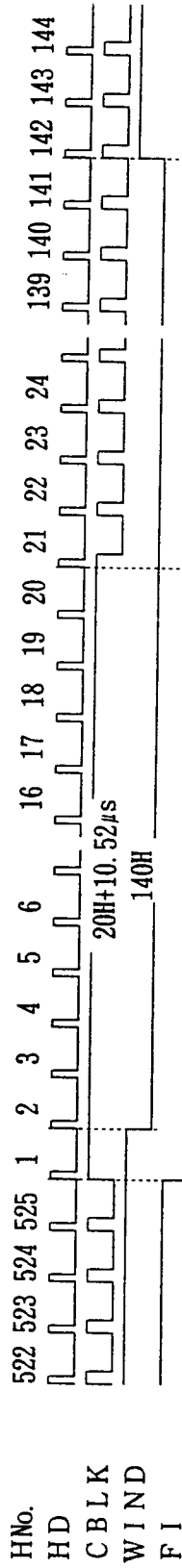

CCIR

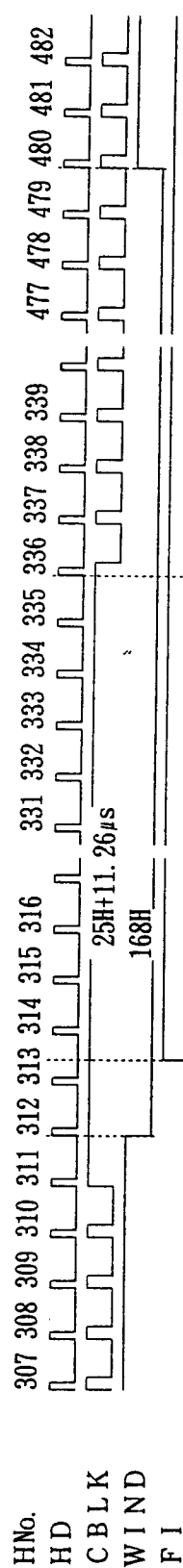
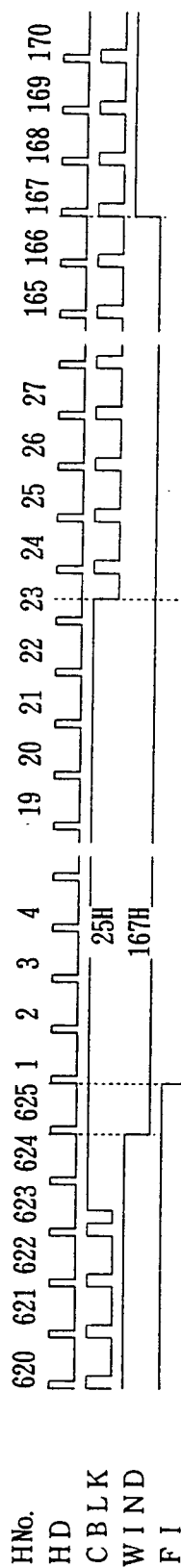

6-4. Timing of the Fast pulse
EIA (1)

1ck=74.07ns

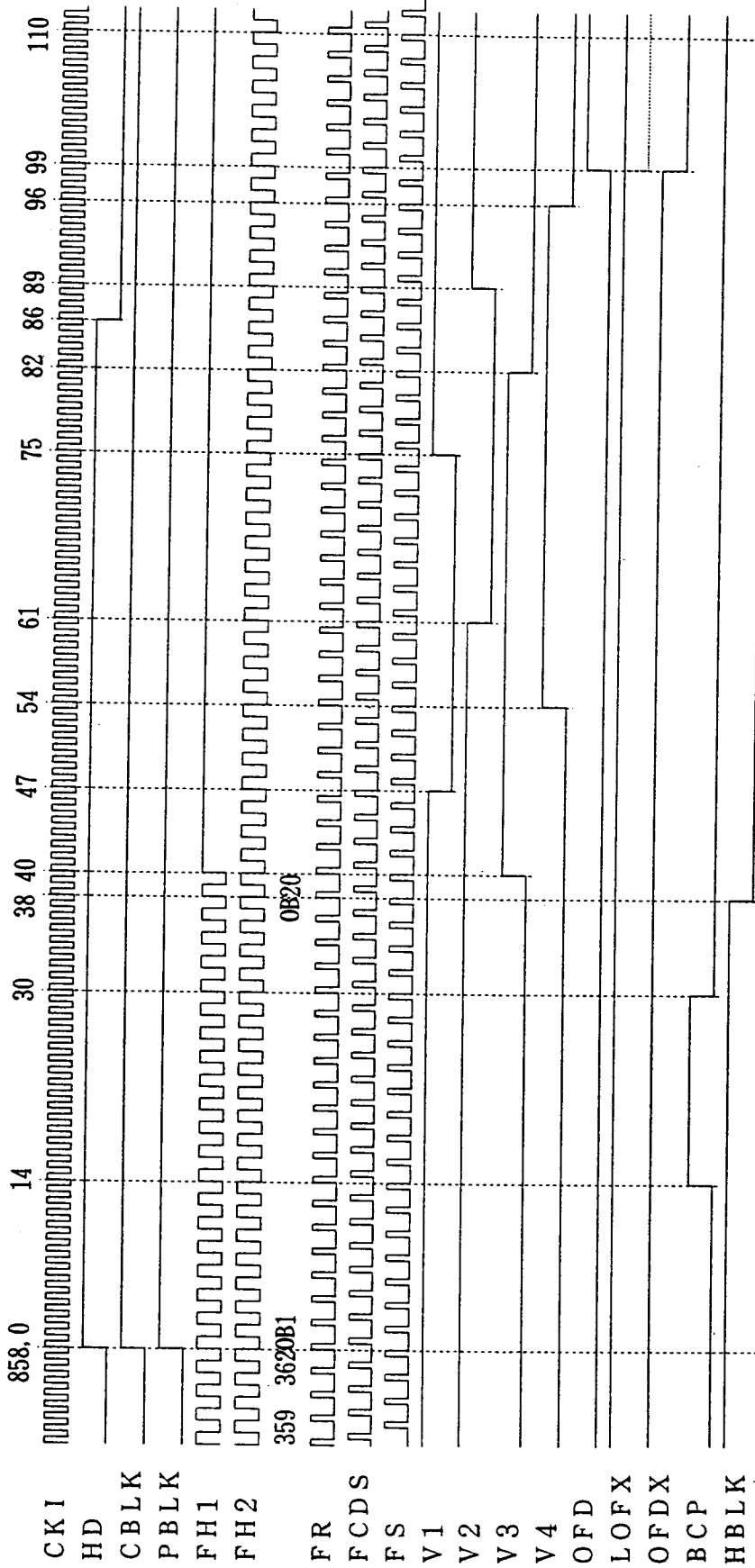

EIA (2)

1clk=74.07ns

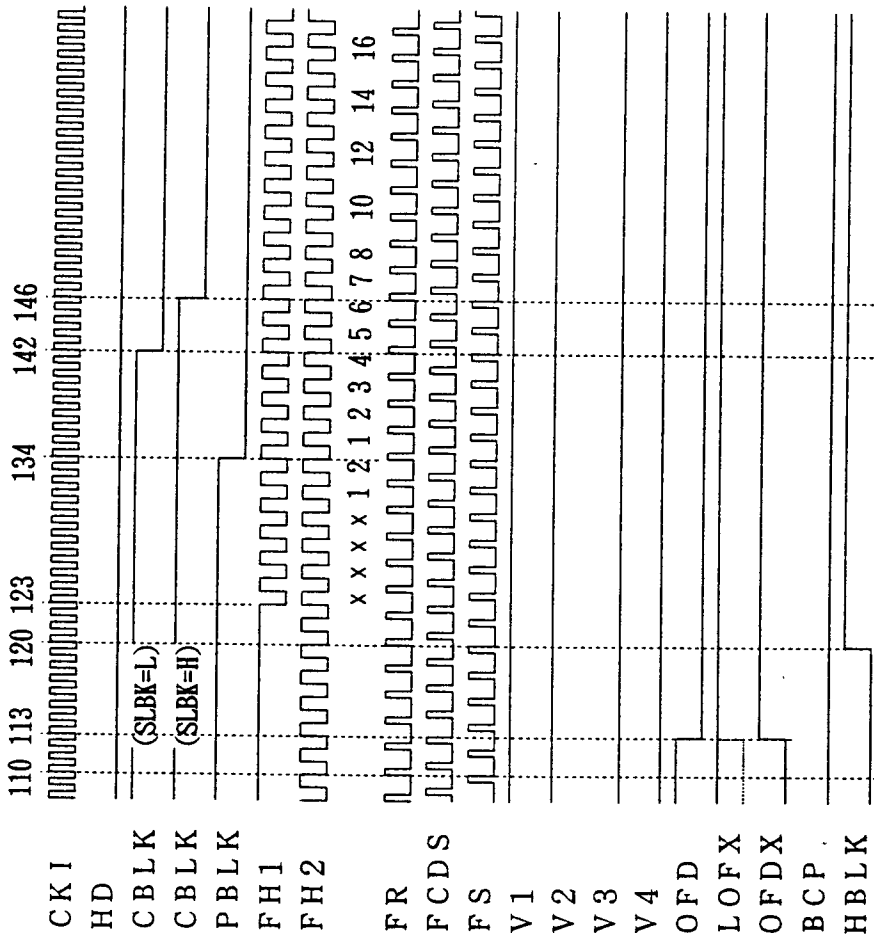

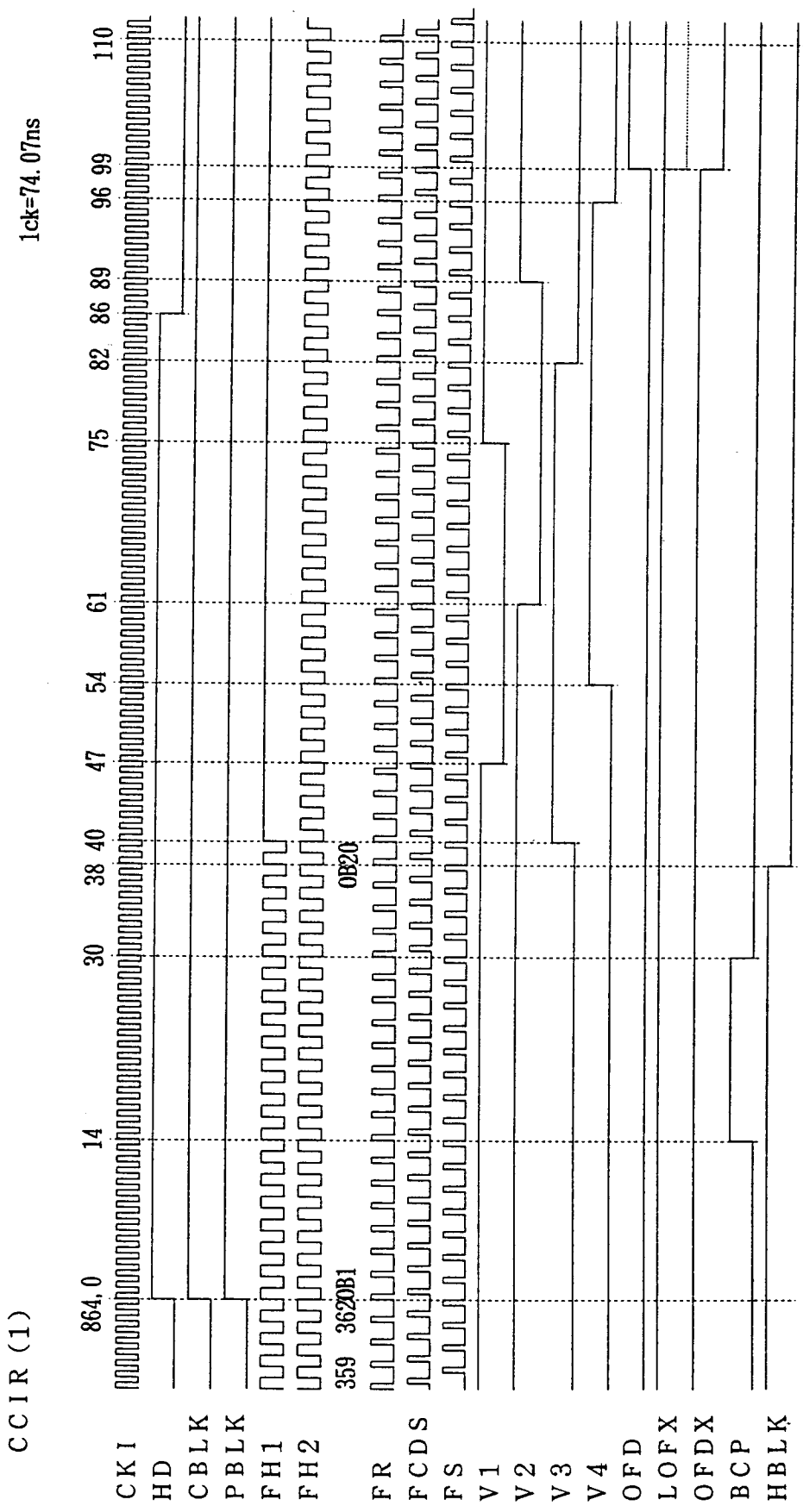

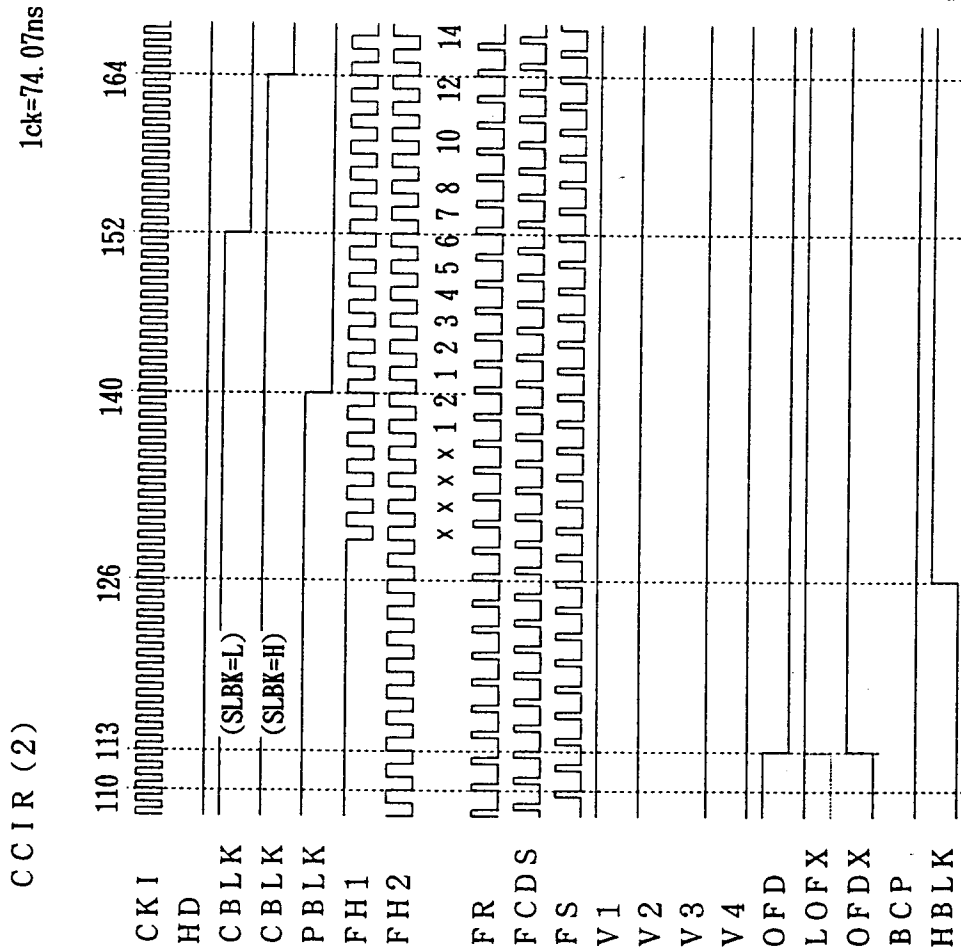

6-3. Timing of the horizontal synchronus pulse

E I A

Unit: μ s (); Number of the CKI

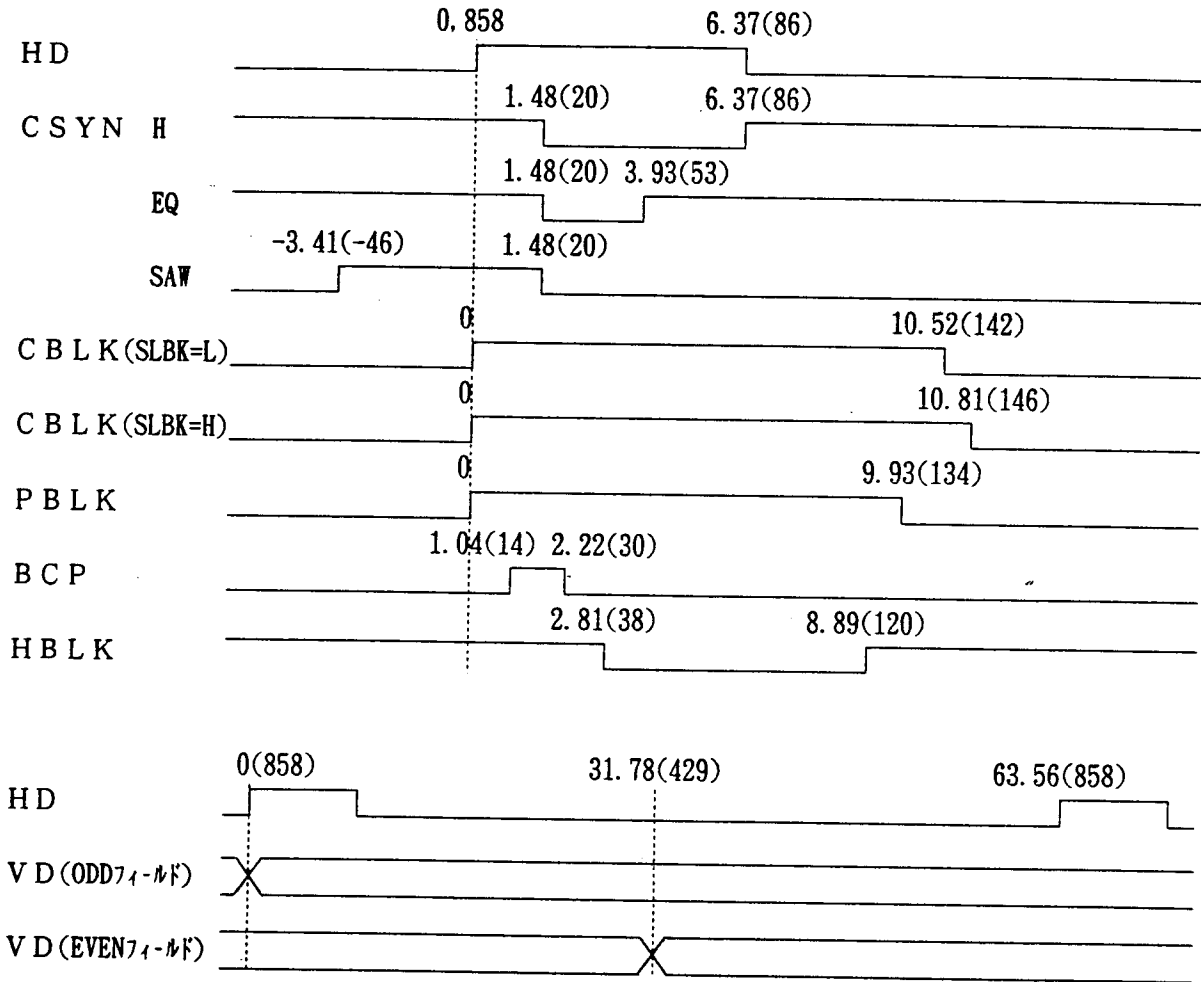

CCIR

Unit: μ s (); Number of the CKI

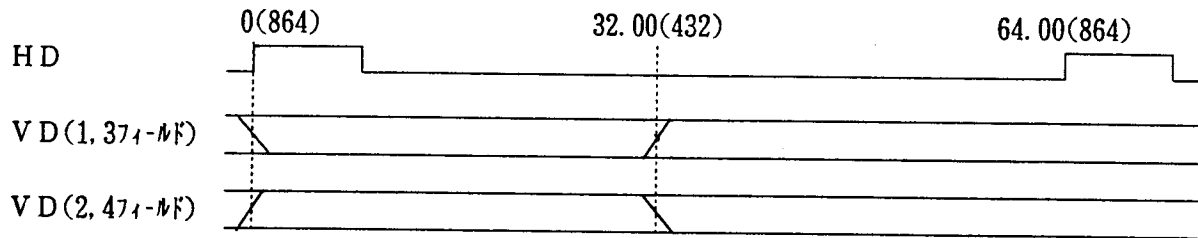
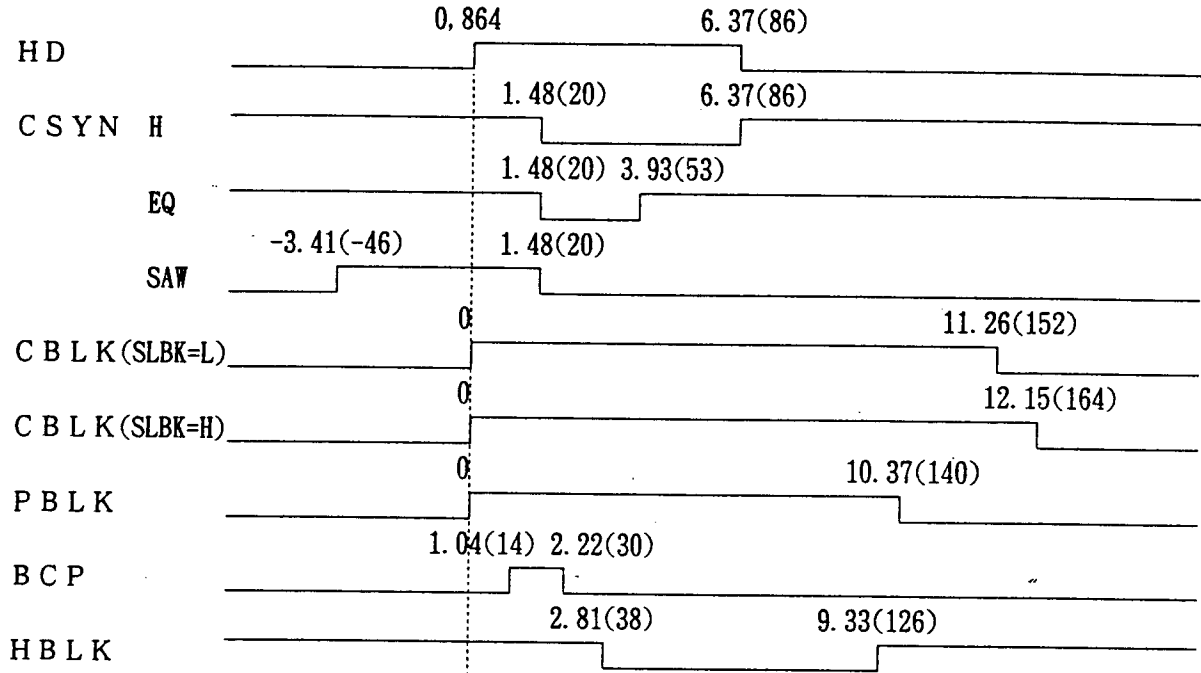

6-5. Timing of the read-out pulse

The number of the CKI () ; CCIR

ODD(1,3) Field

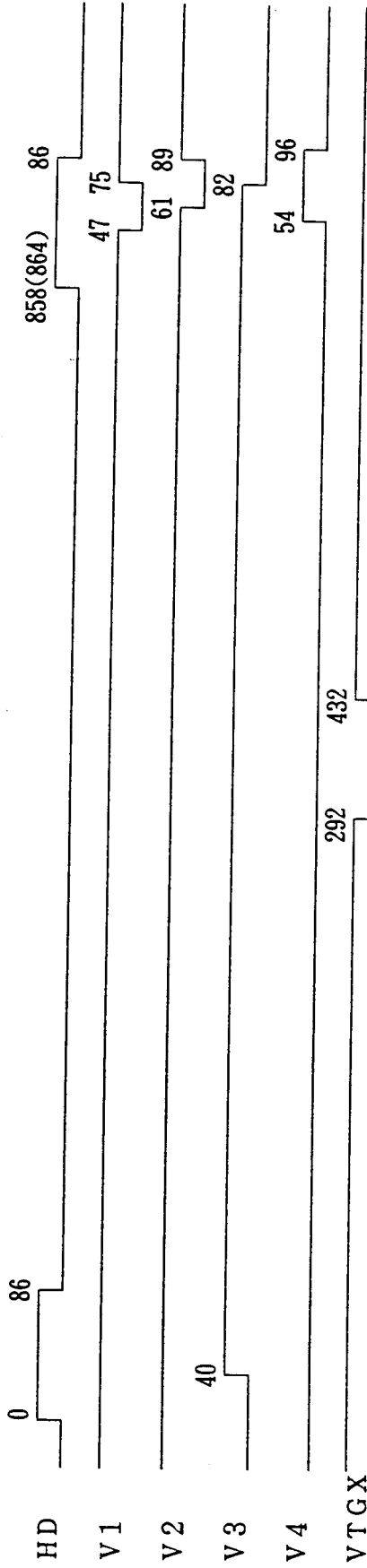

EVEN(2,4) Field

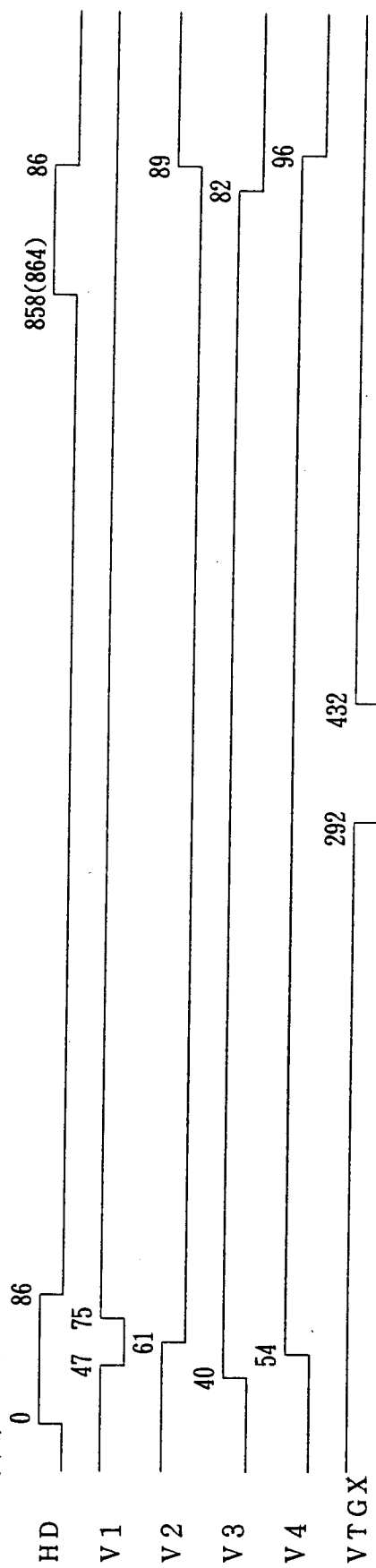

6-6. Timing of the Sweep pulse

The number of the CKI () ; CCIR

•At shutter speed changed 9H, 4H or 1H

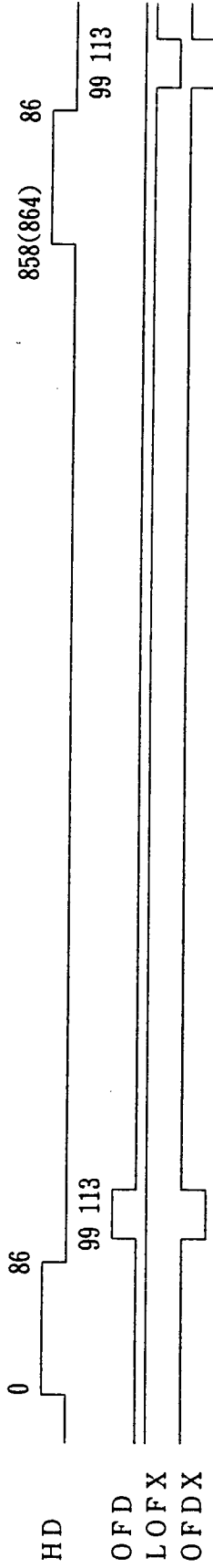

•At 1/4, 900 sec(1/4, 870 sec) with shutter speed changed 0.25H

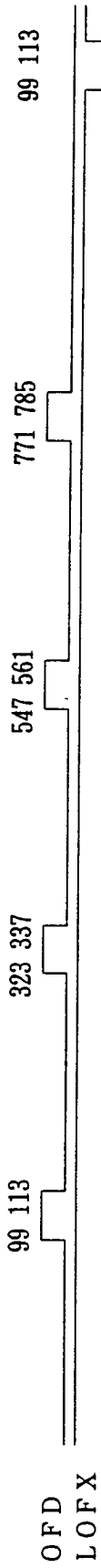

•At max. shutter speed 1/103, 850 sec(1/103, 850)

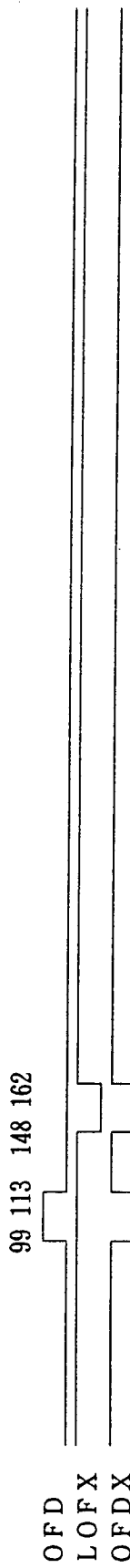

7 Package and packing specification

1. Package Outline Specification

Refer to drawing No. AA1035

2. Markings

2-1. Marking contents

(1) Product name : LZ9GG32M

(2) Company name : SHARP

(3) Date code

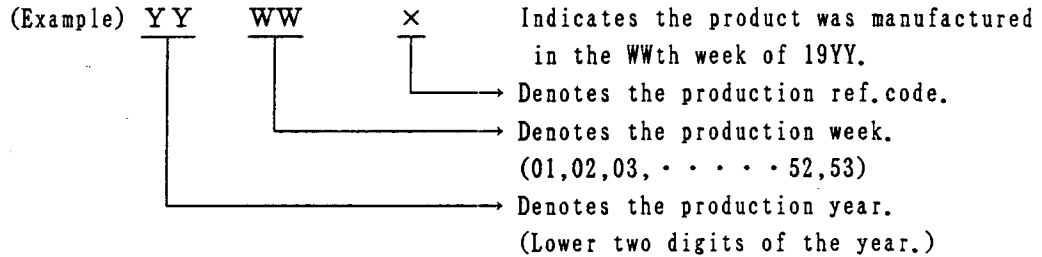

(4) The marking of "JAPAN" indicates the country of origin.

2-2. Marking layout

Refer to drawing No. AA1035

(This layout do not define the dimensions of marking character and marking position.)

3. Packing Specification

3-1. Packing materials

Material Name	Material Specification	Purpose
Tray	Conductive plastic (80devices/tray)	Fixing of device
Upper cover tray	Conductive plastic (1tray/case)	Fixing of device
Laminated aluminum bag	Aluminum polyethylene (1bag/case)	Drying of device
Desiccant	Silica gel	Drying of device
P P band	polypropylene (3 pcs/case)	Device tray fixing
Inner case	Card board (800devices/case)	Packaging of device
Label	Paper	Indicates part number, quantity and date of manufacture
Outer case	Cardboard	Outer packing of device case

(Devices shall be placed into a tray in the same direction.)

3-2. Outline dimension of tray

Refer to attached drawing

4. Precaution For Unpacking

(1) Unpacking should be done on the stand as well as human body treated with anti-ESD.

(2) Conductive treatment or anti-ESD treatment is given to a dray.

Use the equivalent tray, if it is changed to another one.

5. Surface Mount Conditions

Please perform the following conditions when mounting ICs not to deteriorate IC quality.

5-1. Soldering conditions (The following conditions are valid only for one time soldering.)

Mounting Method	Temperature and Duration	Measurement Point
Reflow soldering (air)	Peak temperature of 240°C, duration less than 15 seconds above 230°C, temperature increase rate of 1~4°C/second	IC surface
Vapor phase soldering	215°C or less, duration less than 40 seconds above 200°C	Steam
Manual soldering (soldering iron)	260°C or less, duration less than 10 seconds	IC outer lead surface

5-2. Conditions for removal of residual flux

- (1) Ultrasonic washing power : 25 Watts/liter or less
- (2) Washing time : Total 1 minute maximum
- (3) Solvent temperature : 15~40°C

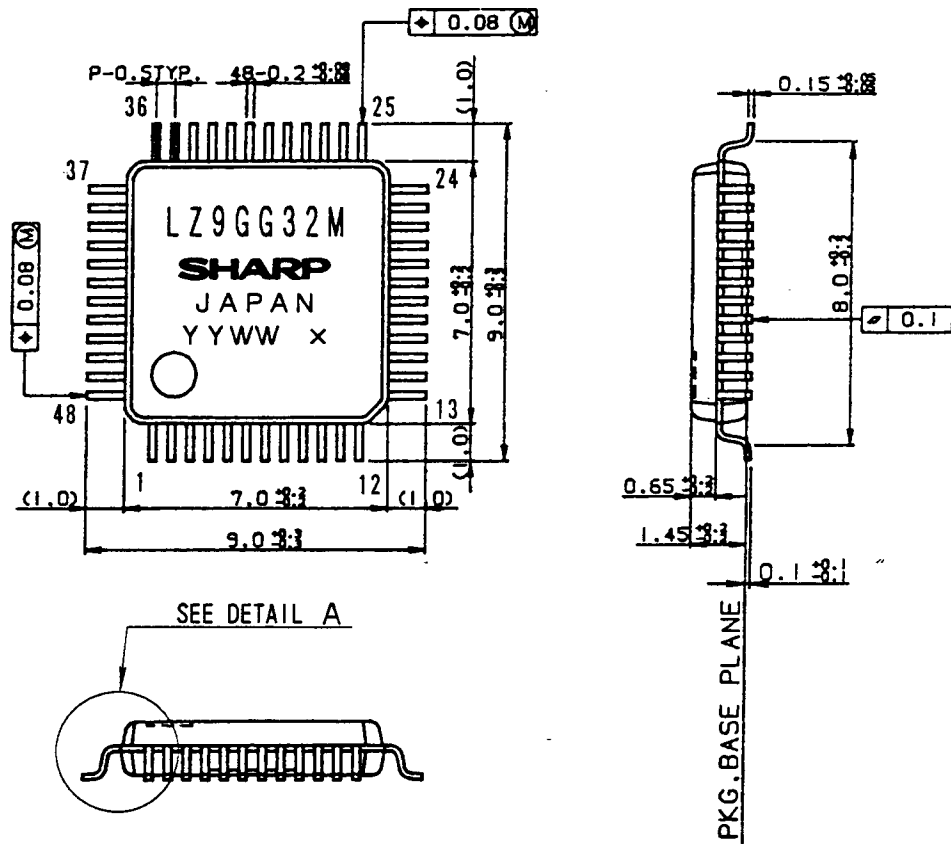

SEE DETAIL A

DETAIL A

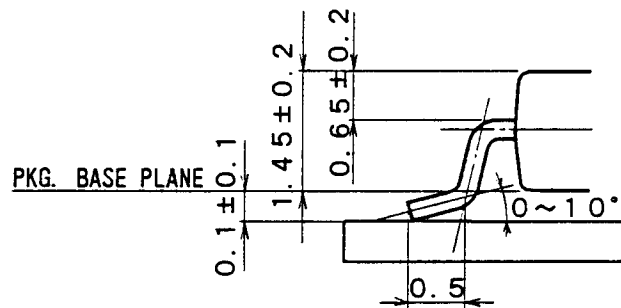

名称	リード仕上	TIN-LEAD	備考
NAME	LEAD FINISH	PLATING	プラスチックパッケージ外形寸法は、バリを含まないものとする。
DRAWING NO	単位	INIT	NOTE
AA1035	mm		Plastic body dimensions do not include burr of resin.

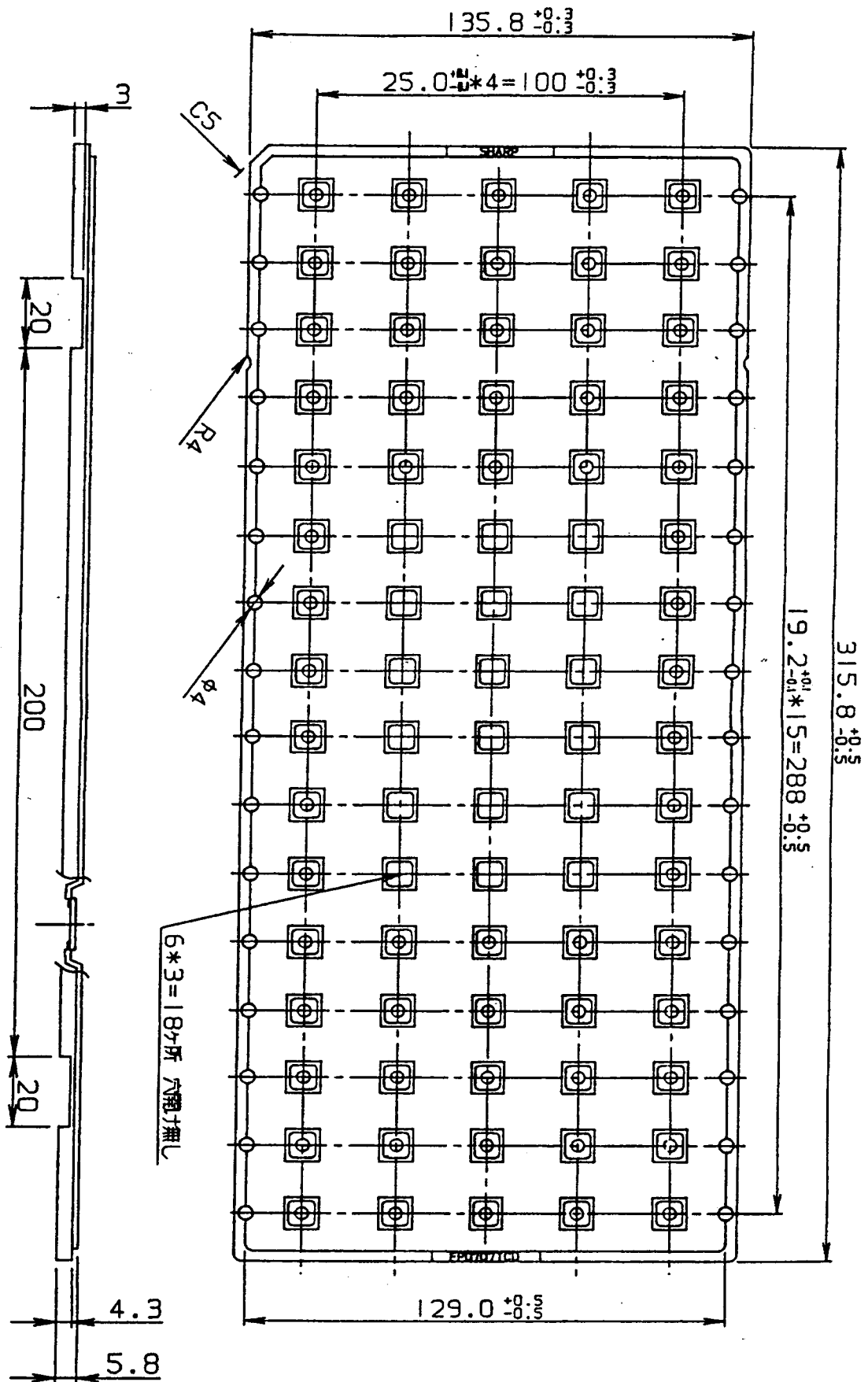

名称 NAME	FP0707TCD		備考 NOTE
DRAWING NO.	CV536	単位 UNIT	mm

CCD, sensor, imaging, area sensor, pattern recognition, timing generator, vertical driver, white balance, LSI, LZ9GG32M