

# MC14094B

## 8-Stage Shift/Store Register with Three-State Outputs

The MC14094B combines an 8-stage shift register with a data latch for each stage and a 3-state output from each latch.

Data is shifted on the positive clock transition and is shifted from the seventh stage to two serial outputs. The  $Q_5$  output data is for use in high-speed cascaded systems. The  $Q_5$  output data is shifted on the following negative clock transition for use in low-speed cascaded systems.

Data from each stage of the shift register is latched on the negative transition of the strobe input. Data propagates through the latch while strobe is high.

Outputs of the eight data latches are controlled by 3-state buffers which are placed in the high-impedance state by a logic Low on Output Enable.

### Features

- 3-State Outputs
- Capable of Driving Two Low-Power TTL Loads or One Low-Power Schottky TTL Load Over the Rated Temperature Range
- Input Diode Protection
- Data Latch
- Dual Outputs for Data Out on Both Positive and Negative Clock Transitions
- Useful for Serial-to-Parallel Data Conversion
- Pin-for-Pin Compatible with CD4094B
- Pb-Free Packages are Available\*

### MAXIMUM RATINGS (Voltages Referenced to $V_{SS}$ )

Symbol	Parameter	Value	Unit
$V_{DD}$	DC Supply Voltage Range	-0.5 to +18.0	V
$V_{in}, V_{out}$	Input or Output Voltage Range (DC or Transient)	-0.5 to $V_{DD} + 0.5$	V
$I_{in}, I_{out}$	Input or Output Current (DC or Transient) per Pin	$\pm 10$	mA
$P_D$	Power Dissipation, per Package (Note 1)	500	mW
$T_A$	Ambient Temperature Range	-55 to +125	$^{\circ}C$
$T_{stg}$	Storage Temperature Range	-65 to +150	$^{\circ}C$
$T_L$	Lead Temperature (8-Second Soldering)	260	$^{\circ}C$

1. Temperature Derating:  
Plastic "P and D/DW" Packages: - 7.0 mW/ $^{\circ}C$  From 65 $^{\circ}C$  To 125 $^{\circ}C$

This device contains protection circuitry to guard against damage due to high static voltages or electric fields. However, precautions must be taken to avoid applications of any voltage higher than maximum rated voltages to this high-impedance circuit. For proper operation,  $V_{in}$  and  $V_{out}$  should be constrained to the range  $V_{SS} \leq (V_{in} \text{ or } V_{out}) \leq V_{DD}$ .

Unused inputs must always be tied to an appropriate logic voltage level (e.g., either  $V_{SS}$  or  $V_{DD}$ ). Unused outputs must be left open.



ON Semiconductor®

<http://onsemi.com>

### MARKING DIAGRAMS

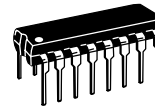

PDIP-16  
P SUFFIX  
CASE 648

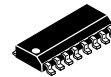
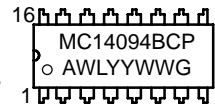

SOIC-16  
D SUFFIX  
CASE 751B

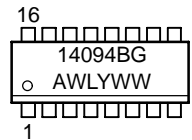

TSSOP-16  
DT SUFFIX  
CASE 948F

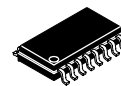
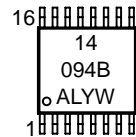

SOEIAJ-16  
F SUFFIX  
CASE 966

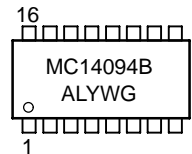

- A = Assembly Location
- WL, L = Wafer Lot
- YY, Y = Year
- WW, W = Work Week
- G = Pb-Free Indicator

### ORDERING INFORMATION

See detailed ordering and shipping information in the package dimensions section on page 2 of this data sheet.

\*For additional information on our Pb-Free strategy and soldering details, please download the ON Semiconductor Soldering and Mounting Techniques Reference Manual, SOLDERRM/D.

# MC14094B

## PIN ASSIGNMENT

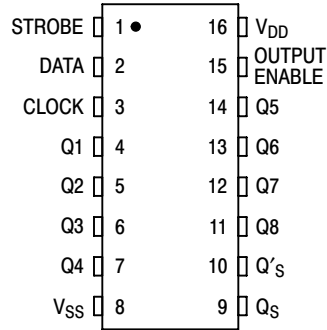

## TRUTH TABLE

Clock	Output Enable	Strobe	Data	Parallel Outputs		Serial Outputs	
				Q <sub>1</sub>	Q <sub>N</sub>	Q <sub>S</sub> *	Q' <sub>S</sub>
	0	X	X	Z	Z	Q <sub>7</sub>	No Chg.
	0	X	X	Z	Z	No Chg.	Q <sub>7</sub>
	1	0	X	No Chg.	No Chg.	Q <sub>7</sub>	No Chg.
	1	1	0	0	Q <sub>N-1</sub>	Q <sub>7</sub>	No Chg.
	1	1	1	1	Q <sub>N-1</sub>	Q <sub>7</sub>	No Chg.
	1	1	1	No Chg.	No Chg.	No Chg.	Q <sub>7</sub>

Z = High Impedance    X = Don't Care

\* At the positive clock edge, information in the 7th shift register stage is transferred to Q<sub>8</sub> and Q<sub>S</sub>.

## ORDERING INFORMATION

Device	Package	Shipping <sup>†</sup>
MC14094BCP	PDIP-16	500 Units / Rail
MC14094BCPG	PDIP-16 (Pb-Free)	500 Units / Rail
MC14094BD	SOIC-16	48 Units / Rail
MC14094BDG	SOIC-16 (Pb-Free)	48 Units / Rail
MC14094BDR2	SOIC-16	2500 Units / Tape & Reel
MC14094BDR2G	SOIC-16 (Pb-Free)	2500 Units / Tape & Reel
MC14094BDTR2	TSSOP-16*	2500 Units / Tape & Reel
MC14094BF	SOEIAJ-16	50 Units / Rail
MC14094BFG	SOEIAJ-16 (Pb-Free)	50 Units / Rail
MC14094BFEL	SOEIAJ-16	2000 Units / Tape & Reel
MC14094BFELG	SOEIAJ-16 (Pb-Free)	2000 Units / Tape & Reel

<sup>†</sup>For information on tape and reel specifications, including part orientation and tape sizes, please refer to our Tape and Reel Packaging Specifications Brochure, BRD8011/D.

\*This package is inherently Pb-Free.

# MC14094B

## ELECTRICAL CHARACTERISTICS (Voltages Referenced to $V_{SS}$ )

Characteristic	Symbol	$V_{DD}$ Vdc	- 55 °C		25 °C			125 °C		Unit	
			Min	Max	Min	Typ <sup>(2)</sup>	Max	Min	Max		
Output Voltage $V_{in} = V_{DD}$ or 0	"0" Level $V_{OL}$	5.0	-	0.05	-	0	0.05	-	0.05	Vdc	
		10	-	0.05	-	0	0.05	-	0.05		
		15	-	0.05	-	0	0.05	-	0.05		
	"1" Level $V_{in} = 0$ or $V_{DD}$	$V_{OH}$	5.0	4.95	-	4.95	5.0	-	4.95		-
			10	9.95	-	9.95	10	-	9.95		-
			15	14.95	-	14.95	15	-	14.95		-
Input Voltage $(V_O = 4.5$ or $0.5$ Vdc) $(V_O = 9.0$ or $1.0$ Vdc) $(V_O = 13.5$ or $1.5$ Vdc)	"0" Level $V_{IL}$	5.0	-	1.5	-	2.25	1.5	-	1.5	Vdc	
		10	-	3.0	-	4.50	3.0	-	3.0		
		15	-	4.0	-	6.75	4.0	-	4.0		
	"1" Level $V_{IH}$	5.0	3.5	-	3.5	2.75	-	3.5	-		
			10	7.0	-	7.0	5.50	-	7.0		-
			15	11	-	11	8.25	-	11		-
Output Drive Current $(V_{OH} = 2.5$ Vdc) $(V_{OH} = 4.6$ Vdc) $(V_{OH} = 9.5$ Vdc) $(V_{OH} = 13.5$ Vdc)	Source $I_{OH}$	5.0	-3.0	-	-2.4	-4.2	-	-1.7	-	mAdc	
		5.0	-0.64	-	-0.51	-0.88	-	-0.36	-		
		10	-1.6	-	-1.3	-2.25	-	-0.9	-		
		15	-4.2	-	-3.4	-8.8	-	-2.4	-		
	Sink $I_{OL}$	5.0	0.64	-	0.51	0.88	-	0.36	-		mAdc
			10	1.6	-	1.3	2.25	-	0.9		
15	4.2	-	3.4	8.8	-	2.4	-	-			
Input Current	$I_{in}$	15	-	$\pm 0.1$	-	$\pm 0.00001$	$\pm 0.1$	-	$\pm 1.0$	$\mu$ Adc	
Input Capacitance $(V_{in} = 0)$	$C_{in}$	-	-	-	-	5.0	7.5	-	-	pF	
Quiescent Current (Per Package)	$I_{DD}$	5.0	-	5.0	-	0.005	5.0	-	150	$\mu$ Adc	
		10	-	10	-	0.010	10	-	300		
		15	-	20	-	0.015	20	-	600		
Total Supply Current <sup>(3)</sup> <sup>(4)</sup> (Dynamic plus Quiescent, Per Package) $(C_L = 50$ pF on all outputs, all buffers switching)	$I_T$	5.0	$I_T = (4.1 \mu\text{A/kHz}) f + I_{DD}$							$\mu$ Adc	
		10	$I_T = (14 \mu\text{A/kHz}) f + I_{DD}$								
		15	$I_T = (140 \mu\text{A/kHz}) f + I_{DD}$								
3-State Output Leakage Current	$I_{TL}$	15	-	$\pm 0.1$	-	$\pm 0.0001$	$\pm 0.1$	-	$\pm 3.0$	$\mu$ A	

2. Data labelled "Typ" is not to be used for design purposes but is intended as an indication of the IC's potential performance.

3. The formulas given are for the typical characteristics only at 25 °C.

4. To calculate total supply current at loads other than 50 pF:

$$I_T(C_L) = I_T(50 \text{ pF}) + (C_L - 50) Vfk$$

where:  $I_T$  is in  $\mu$ A (per package),  $C_L$  in pF,  $V = (V_{DD} - V_{SS})$  in volts,  $f$  in kHz is input frequency, and  $k = 0.001$ .



# MC14094B

## 3-STATE TEST CIRCUIT

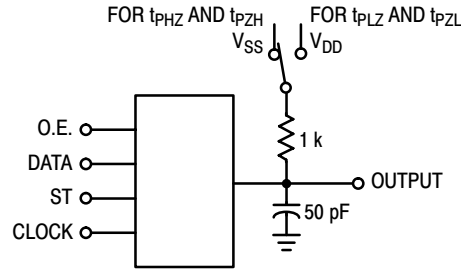

## BLOCK DIAGRAM

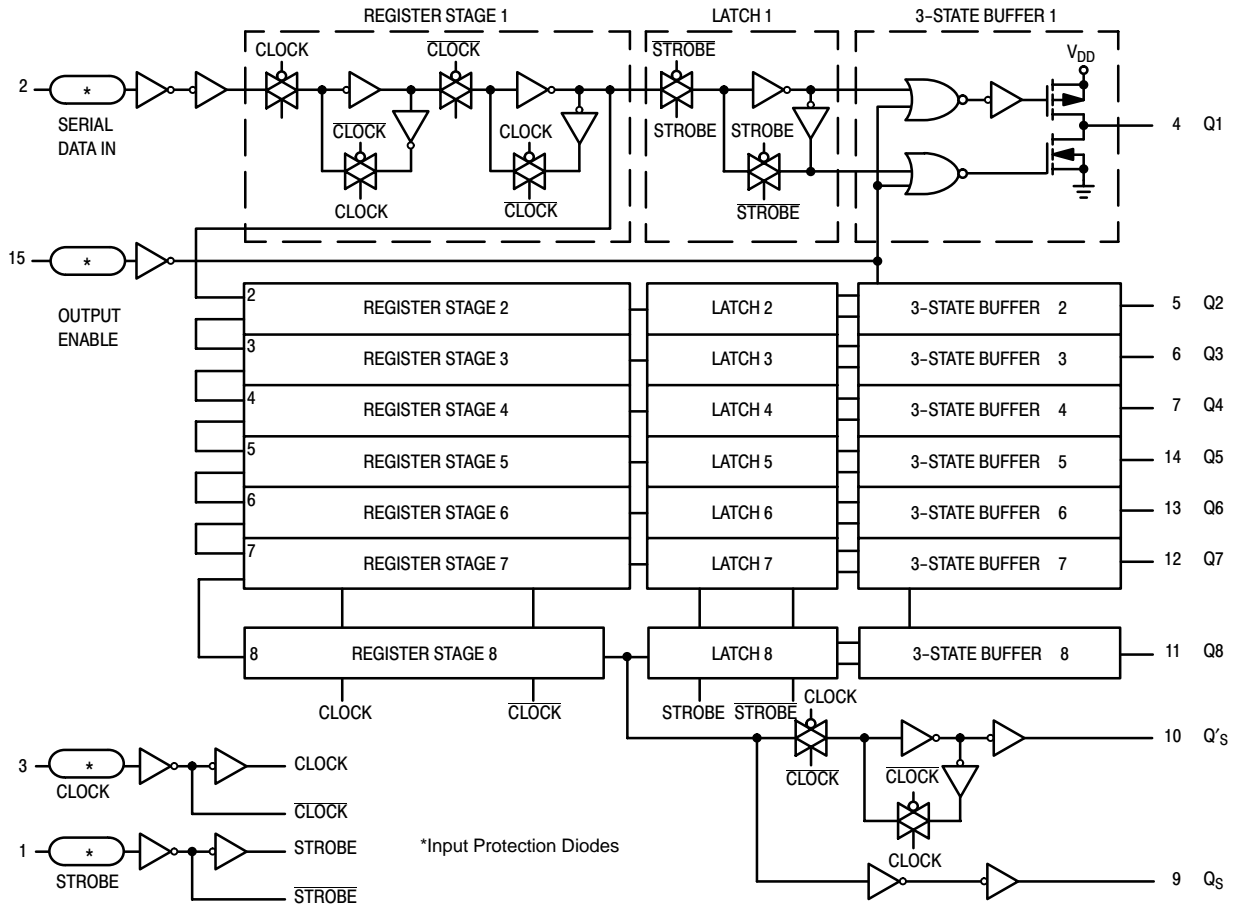

# MC14094B

## DYNAMIC TIMING DIAGRAM

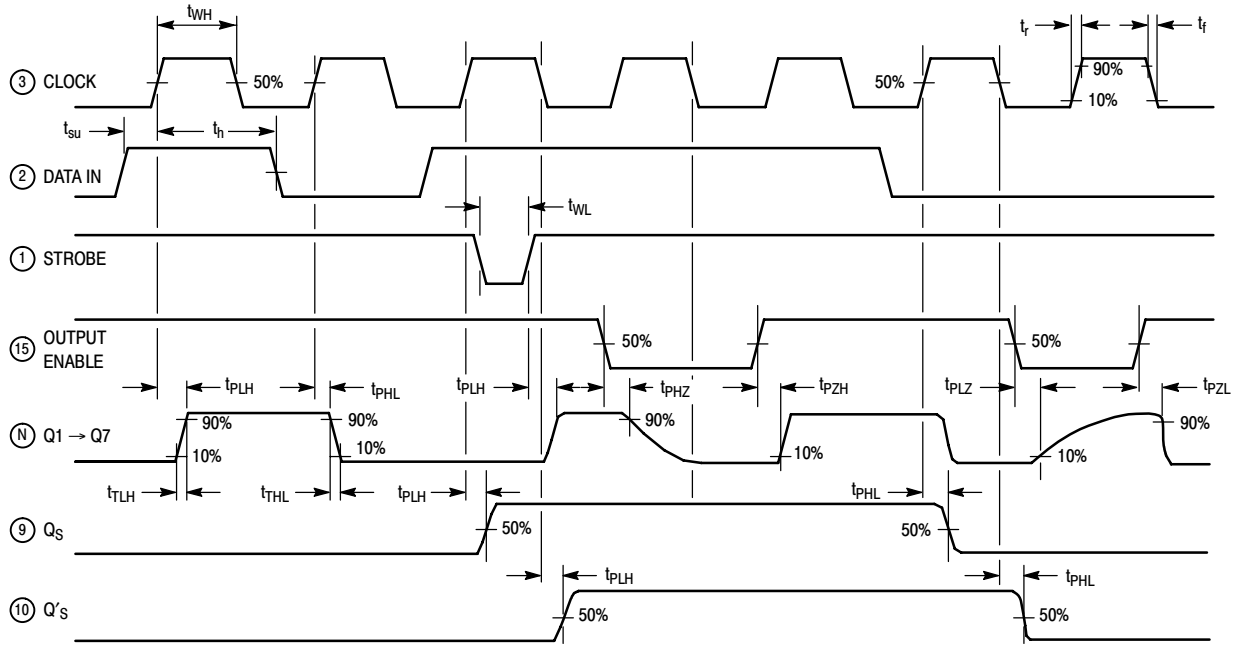

# MC14094B

## PACKAGE DIMENSIONS

PDIP-16  
P SUFFIX  
PLASTIC DIP PACKAGE  
CASE 648-08  
ISSUE T

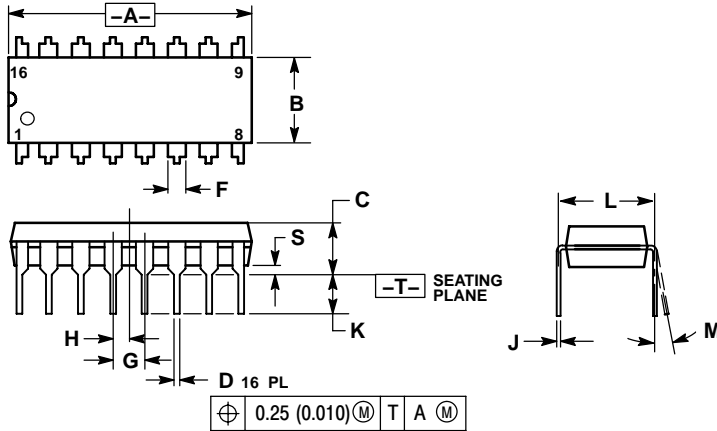

NOTES:

1. DIMENSIONING AND TOLERANCING PER ANSI Y14.5M, 1982.
2. CONTROLLING DIMENSION: INCH.
3. DIMENSION L TO CENTER OF LEADS WHEN FORMED PARALLEL.
4. DIMENSION B DOES NOT INCLUDE MOLD FLASH.
5. ROUNDED CORNERS OPTIONAL.

DIM	INCHES		MILLIMETERS	
	MIN	MAX	MIN	MAX
A	0.740	0.770	18.80	19.55
B	0.250	0.270	6.35	6.85
C	0.145	0.175	3.69	4.44
D	0.015	0.021	0.39	0.53
F	0.040	0.70	1.02	1.77
G	0.100 BSC		2.54 BSC	
H	0.050 BSC		1.27 BSC	
J	0.008	0.015	0.21	0.38
K	0.110	0.130	2.80	3.30
L	0.295	0.305	7.50	7.74
M	0°	10°	0°	10°
S	0.020	0.040	0.51	1.01

SOIC-16  
D SUFFIX  
PLASTIC SOIC PACKAGE  
CASE 751B-05  
ISSUE J

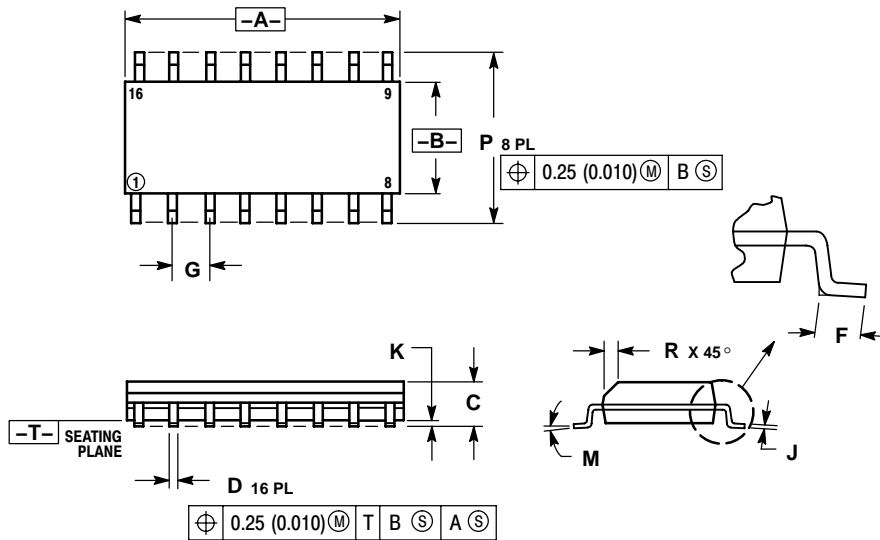

NOTES:

1. DIMENSIONING AND TOLERANCING PER ANSI Y14.5M, 1982.
2. CONTROLLING DIMENSION: MILLIMETER.
3. DIMENSIONS A AND B DO NOT INCLUDE MOLD PROTRUSION.
4. MAXIMUM MOLD PROTRUSION 0.15 (0.006) PER SIDE.
5. DIMENSION D DOES NOT INCLUDE DAMBAR PROTRUSION. ALLOWABLE DAMBAR PROTRUSION SHALL BE 0.127 (0.005) TOTAL IN EXCESS OF THE D DIMENSION AT MAXIMUM MATERIAL CONDITION.

DIM	MILLIMETERS		INCHES	
	MIN	MAX	MIN	MAX
A	9.80	10.00	0.386	0.393
B	3.80	4.00	0.150	0.157
C	1.35	1.75	0.054	0.068
D	0.35	0.49	0.014	0.019
F	0.40	1.25	0.016	0.049
G	1.27 BSC		0.050 BSC	
J	0.19	0.25	0.008	0.009
K	0.10	0.25	0.004	0.009
M	0°	7°	0°	7°
P	5.80	6.20	0.229	0.244
R	0.25	0.50	0.010	0.019

# MC14094B

## PACKAGE DIMENSIONS

TSSOP-16  
DT SUFFIX  
PLASTIC TSSOP PACKAGE  
CASE 948F-01  
ISSUE A

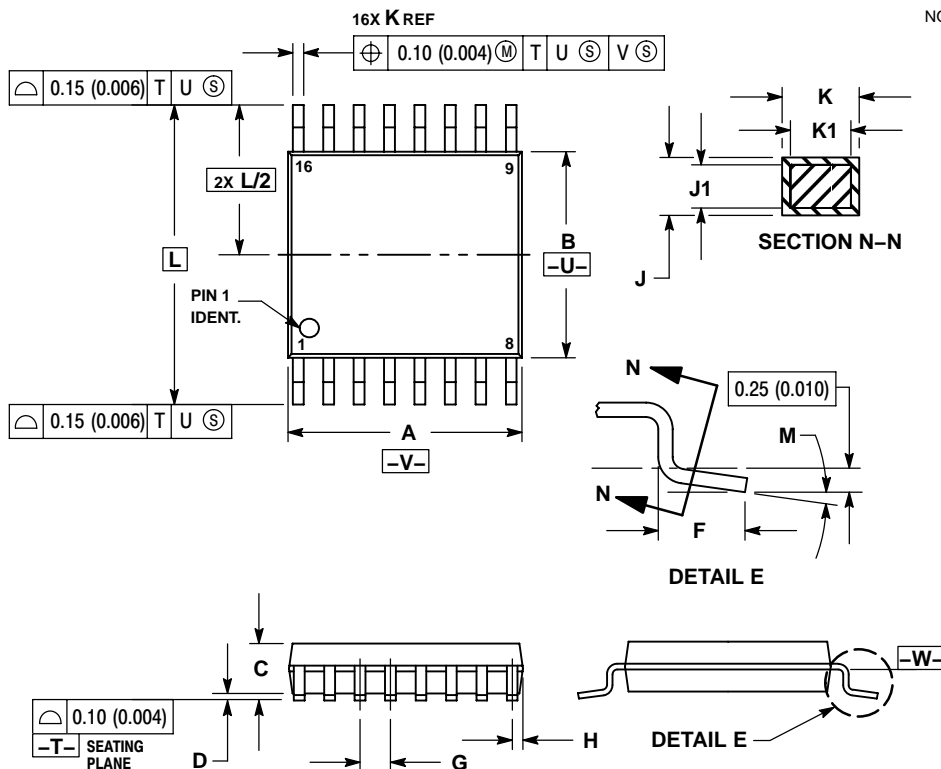

### NOTES:

1. DIMENSIONING AND TOLERANCING PER ANSI Y14.5M, 1982.
2. CONTROLLING DIMENSION: MILLIMETER.
3. DIMENSION A DOES NOT INCLUDE MOLD FLASH. PROTRUSIONS OR GATE BURRS. MOLD FLASH OR GATE BURRS SHALL NOT EXCEED 0.15 (0.006) PER SIDE.
4. DIMENSION B DOES NOT INCLUDE INTERLEAD FLASH OR PROTRUSION. INTERLEAD FLASH OR PROTRUSION SHALL NOT EXCEED 0.25 (0.010) PER SIDE.
5. DIMENSION K DOES NOT INCLUDE DAMBAR PROTRUSION. ALLOWABLE DAMBAR PROTRUSION SHALL BE 0.08 (0.003) TOTAL IN EXCESS OF THE K DIMENSION AT MAXIMUM MATERIAL CONDITION.
6. TERMINAL NUMBERS ARE SHOWN FOR REFERENCE ONLY.
7. DIMENSION A AND B ARE TO BE DETERMINED AT DATUM PLANE -W-.

DIM	MILLIMETERS		INCHES	
	MIN	MAX	MIN	MAX
A	4.90	5.10	0.193	0.200
B	4.30	4.50	0.169	0.177
C	---	1.20	---	0.047
D	0.05	0.15	0.002	0.006
F	0.50	0.75	0.020	0.030
G	0.65 BSC		0.026 BSC	
H	0.18	0.28	0.007	0.011
J	0.09	0.20	0.004	0.008
J1	0.09	0.16	0.004	0.006
K	0.19	0.30	0.007	0.012
K1	0.19	0.25	0.007	0.010
L	6.40 BSC		0.252 BSC	
M	0°	8°	0°	8°



# MC14094B

## PACKAGE DIMENSIONS

SOEIAJ-16  
 F SUFFIX  
 PLASTIC EIAJ SOIC PACKAGE  
 CASE 966-01  
 ISSUE O

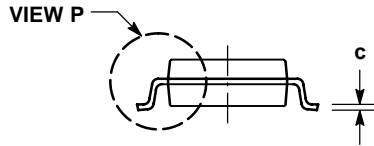
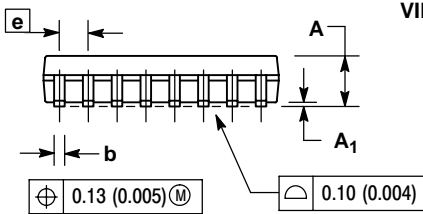
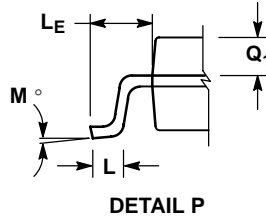
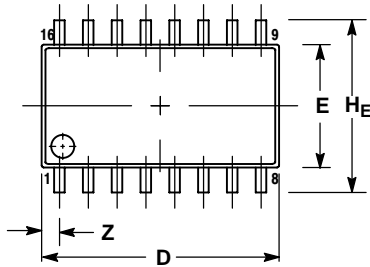

NOTES:

1. DIMENSIONING AND TOLERANCING PER ANSI Y14.5M, 1982.
2. CONTROLLING DIMENSION: MILLIMETER.
3. DIMENSIONS D AND E DO NOT INCLUDE MOLD FLASH OR PROTRUSIONS AND ARE MEASURED AT THE PARTING LINE. MOLD FLASH OR PROTRUSIONS SHALL NOT EXCEED 0.15 (0.006) PER SIDE.
4. TERMINAL NUMBERS ARE SHOWN FOR REFERENCE ONLY.
5. THE LEAD WIDTH DIMENSION (b) DOES NOT INCLUDE DAMBAR PROTRUSION. ALLOWABLE DAMBAR PROTRUSION SHALL BE 0.08 (0.003) TOTAL IN EXCESS OF THE LEAD WIDTH DIMENSION AT MAXIMUM MATERIAL CONDITION. DAMBAR CANNOT BE LOCATED ON THE LOWER RADIUS OR THE FOOT. MINIMUM SPACE BETWEEN PROTRUSIONS AND ADJACENT LEAD TO BE 0.46 (0.018).

DIM	MILLIMETERS		INCHES	
	MIN	MAX	MIN	MAX
A	---	2.05	---	0.081
A <sub>1</sub>	0.05	0.20	0.002	0.008
b	0.35	0.50	0.014	0.020
c	0.18	0.27	0.007	0.011
D	9.90	10.50	0.390	0.413
E	5.10	5.45	0.201	0.215
e	1.27 BSC		0.050 BSC	
H <sub>E</sub>	7.40	8.20	0.291	0.323
L	0.50	0.85	0.020	0.033
L <sub>E</sub>	1.10	1.50	0.043	0.059
M	0°	10°	0°	10°
Q <sub>1</sub>	0.70	0.90	0.028	0.035
Z	---	0.78	---	0.031

# MC14094B

**ON Semiconductor** and **ON** are registered trademarks of Semiconductor Components Industries, LLC (SCILLC). SCILLC reserves the right to make changes without further notice to any products herein. SCILLC makes no warranty, representation or guarantee regarding the suitability of its products for any particular purpose, nor does SCILLC assume any liability arising out of the application or use of any product or circuit, and specifically disclaims any and all liability, including without limitation special, consequential or incidental damages. "Typical" parameters which may be provided in SCILLC data sheets and/or specifications can and do vary in different applications and actual performance may vary over time. All operating parameters, including "Typicals" must be validated for each customer application by customer's technical experts. SCILLC does not convey any license under its patent rights nor the rights of others. SCILLC products are not designed, intended, or authorized for use as components in systems intended for surgical implant into the body, or other applications intended to support or sustain life, or for any other application in which the failure of the SCILLC product could create a situation where personal injury or death may occur. Should Buyer purchase or use SCILLC products for any such unintended or unauthorized application, Buyer shall indemnify and hold SCILLC and its officers, employees, subsidiaries, affiliates, and distributors harmless against all claims, costs, damages, and expenses, and reasonable attorney fees arising out of, directly or indirectly, any claim of personal injury or death associated with such unintended or unauthorized use, even if such claim alleges that SCILLC was negligent regarding the design or manufacture of the part. SCILLC is an Equal Opportunity/Affirmative Action Employer. This literature is subject to all applicable copyright laws and is not for resale in any manner.

## PUBLICATION ORDERING INFORMATION

### LITERATURE FULFILLMENT:

Literature Distribution Center for ON Semiconductor  
P.O. Box 61312, Phoenix, Arizona 85082-1312 USA  
**Phone:** 480-829-7710 or 800-344-3860 Toll Free USA/Canada  
**Fax:** 480-829-7709 or 800-344-3867 Toll Free USA/Canada  
**Email:** [orderlit@onsemi.com](mailto:orderlit@onsemi.com)

**N. American Technical Support:** 800-282-9855 Toll Free  
USA/Canada

**Japan:** ON Semiconductor, Japan Customer Focus Center  
2-9-1 Kamimeguro, Meguro-ku, Tokyo, Japan 153-0051  
**Phone:** 81-3-5773-3850

**ON Semiconductor Website:** <http://onsemi.com>

**Order Literature:** <http://www.onsemi.com/litorder>

For additional information, please contact your  
local Sales Representative.

**MC14094B/D**