



# STPS3045CT/CG/CP/CPI/CW

## POWER SCHOTTKY RECTIFIER

### MAIN PRODUCT CHARACTERISTICS

$I_F(AV)$	2 x 15 A
$V_{RRM}$	45 V
$T_j(max)$	175 °C
$V_F$	0.57 V

### FEATURES AND BENEFITS

- VERY SMALL CONDUCTION LOSSES
- NEGLIGIBLE SWITCHING LOSSES
- EXTREMELY FAST SWITCHING
- LOW THERMAL RESISTANCE
- INSULATED PACKAGE: TOP-3I  
Insulating voltage = 2500V RMS  
Capacitance = 12pF

### DESCRIPTION

Dual center tap Schottky rectifier suited for Switch-Mode Power Supply and high frequency DC to DC converters.

Packaged either in TO-220AB, D<sup>2</sup>PAK, TO-247, SOT93 or TOP-3I, this device is especially intended for use in low voltage, high frequency inverters, free wheeling and polarity protection applications.

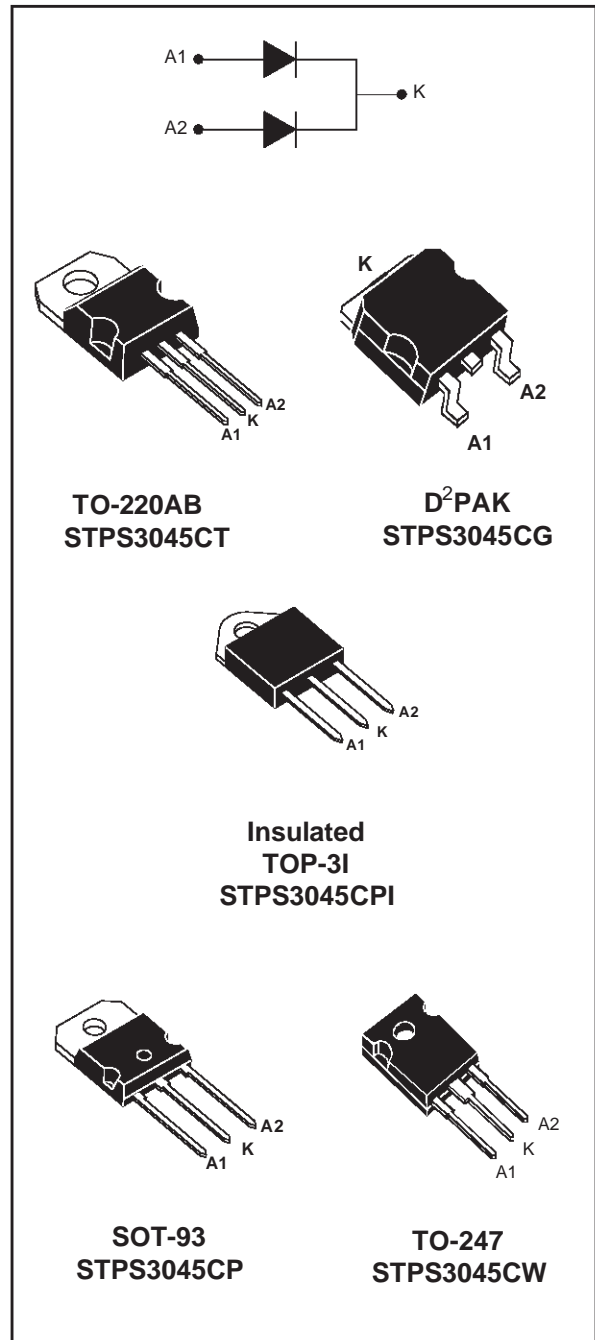

## STPS3045CT/CG/CP/CPI/CW

### ABSOLUTE RATINGS (limiting values, per diode)

Symbol	Parameter			Value	Unit	
V <sub>RRM</sub>	Repetitive peak reverse voltage			45	V	
I <sub>F(RMS)</sub>	RMS forward current			30	A	
I <sub>F(AV)</sub>	Average forward current δ = 0.5	TO-220AB D <sup>2</sup> PAK SOT-93 TO-247	T <sub>c</sub> = 155°C	Per diode Per device	15 30	A
		TOP-3I	T <sub>c</sub> = 150°C			
I <sub>FSM</sub>	Surge non repetitive forward current		tp = 10 ms sinusoidal	220	A	
I <sub>RRM</sub>	Repetitive peak reverse current		tp = 2 μs square F = 1kHz	1	A	
I <sub>RSM</sub>	Non repetitive peak reverse current		tp = 100 μs square	3	A	
T <sub>stg</sub>	Storage temperature range			-65 to +175	°C	
T <sub>j</sub>	Maximum operating junction temperature *			175	°C	
dV/dt	Critical rate of rise of reverse voltage			10000	V/μs	

\* :  $\frac{dP_{tot}}{dT_j} < \frac{1}{R_{th(j-a)}}$  thermal runaway condition for a diode on its own heatsink

### THERMAL RESISTANCES

Symbol	Parameter			Value	Unit
R <sub>th(j-c)</sub>	Junction to case	TO-220AB D <sup>2</sup> PAK	Per diode Total	1.60 0.85	°C/W
		SOT-93 TO-247	Per diode Total	1.5 0.8	
		TOP-3I	Per diode Total	2.2 1.6	
R <sub>th(c)</sub>		TO-220AB D <sup>2</sup> PAK SOT-93 TO-247	Coupling	0.10	
		TOP-3I	Coupling	1.0	

When the diodes 1 and 2 are used simultaneously:

$$\Delta T_j (\text{diode 1}) = P (\text{diode 1}) \times R_{th(j-c)} (\text{per diode}) + P (\text{diode 2}) \times R_{th(c)}$$

STATIC ELECTRICAL CHARACTERISTICS (Per diode)

Symbol	Parameter	Tests Conditions		Min.	Typ.	Max.	Unit
$I_R^*$	Reverse leakage current	$T_j = 25^\circ\text{C}$	$V_R = V_{RRM}$			200	$\mu\text{A}$
		$T_j = 125^\circ\text{C}$			11	40	mA
$V_F^*$	Forward voltage drop	$T_j = 125^\circ\text{C}$	$I_F = 15\text{ A}$		0.5	0.57	V
		$T_j = 25^\circ\text{C}$	$I_F = 30\text{ A}$			0.84	
		$T_j = 125^\circ\text{C}$	$I_F = 30\text{ A}$		0.65	0.72	

Pulse test : \*  $t_p = 380\ \mu\text{s}$ ,  $\delta < 2\%$

To evaluate the conduction losses use the following equation :  
 $P = 0.42 \times I_{F(AV)} + 0.01 I_{F(RMS)}^2$

Fig. 1: Average forward power dissipation versus average forward current (per diode).

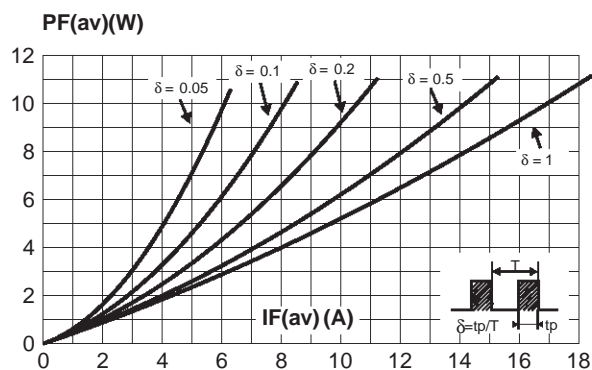
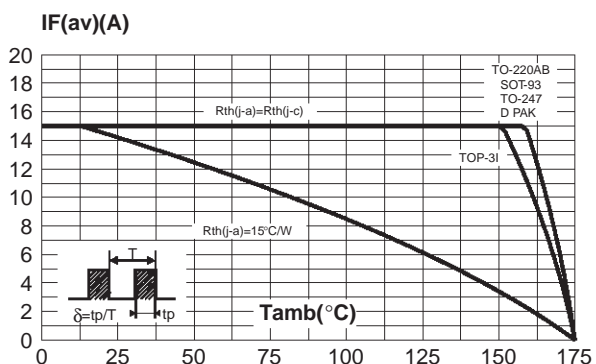
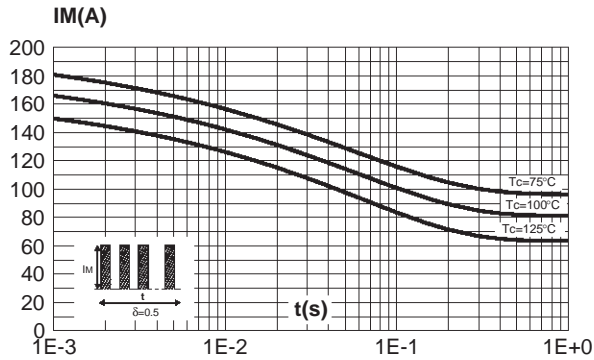

Fig. 2: Average current versus ambient temperature ( $\delta = 0.5$ , per diode).



**Fig. 3-1:** Non repetitive surge peak forward current versus overload duration (maximum values, per diode) (TO-220AB, D<sup>2</sup>PAK, SOT-93 and TO-247).



**Fig. 4:** Relative variation of thermal transient impedance junction to case versus pulse duration.

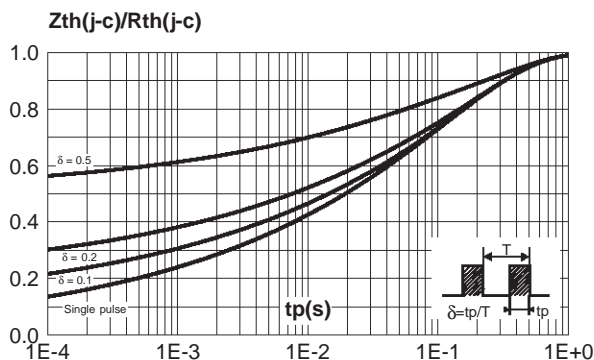

**Fig. 6:** Junction capacitance versus reverse voltage applied (typical values, per diode).

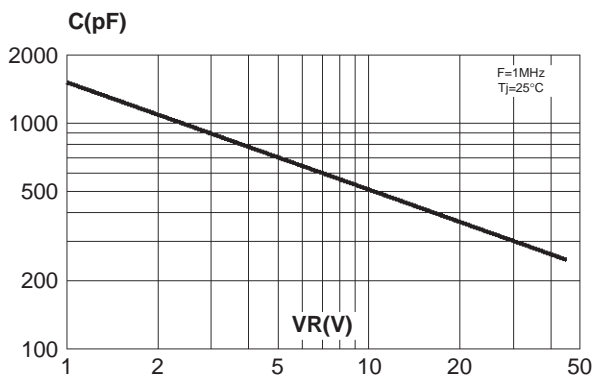

**Fig. 3-2:** Non repetitive surge peak forward current versus overload duration (maximum values, per diode) (TOP-3I).

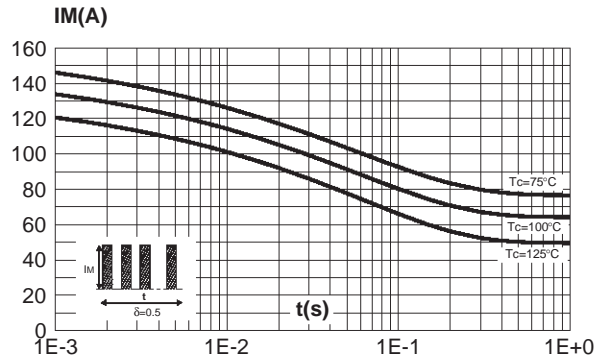

**Fig. 5:** Reverse leakage current versus reverse voltage applied (typical values, per diode).

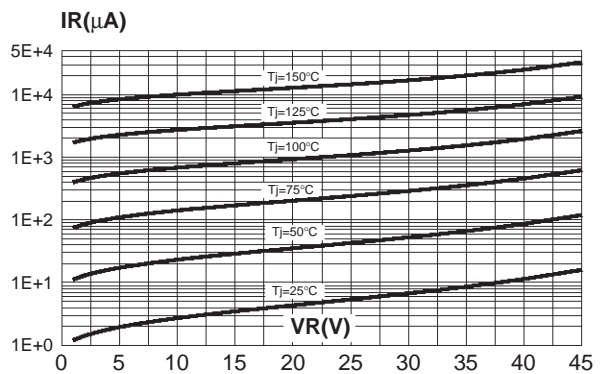

**Fig. 7:** Forward voltage drop versus forward current (maximum values, per diode).

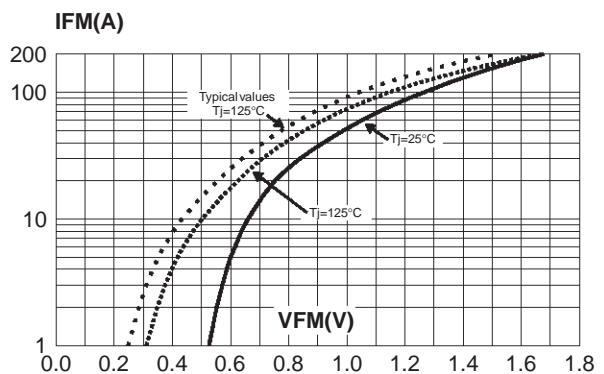

PACKAGE MECHANICAL DATA  
TO-220AB

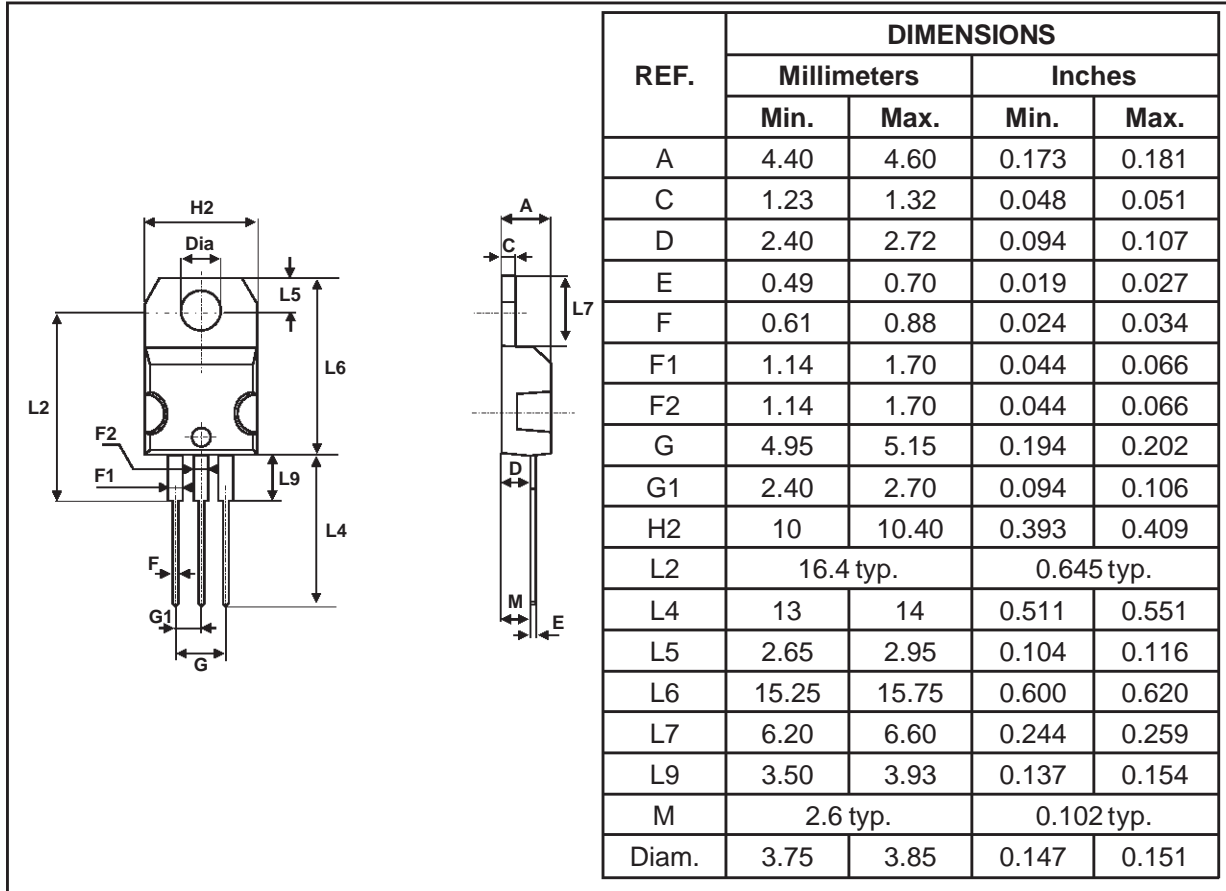

**PACKAGE MECHANICAL DATA**  
D<sup>2</sup>PAK

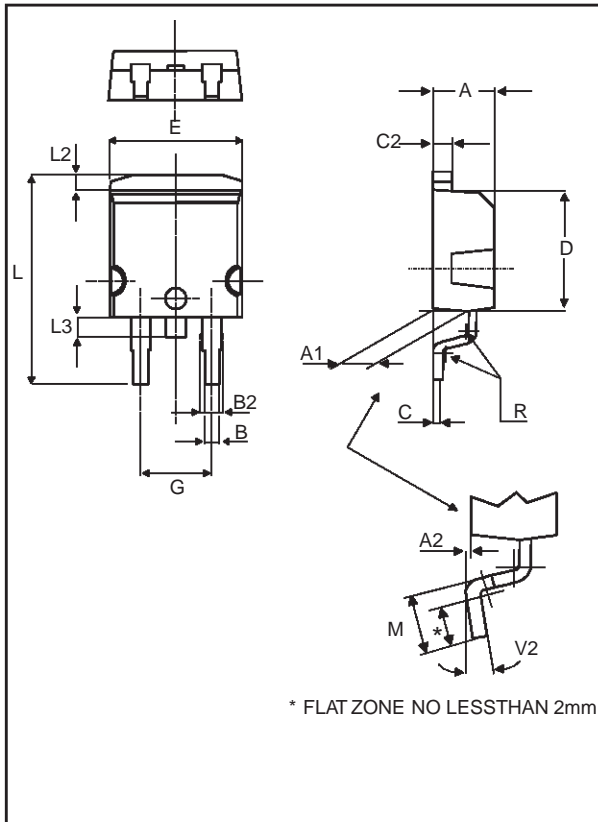

REF.	DIMENSIONS			
	Millimeters		Inches	
	Min.	Max.	Min.	Max.
A	4.40	4.60	0.173	0.181
A1	2.49	2.69	0.098	0.106
A2	0.03	0.23	0.001	0.009
B	0.70	0.93	0.027	0.037
B2	1.14	1.70	0.045	0.067
C	0.45	0.60	0.017	0.024
C2	1.23	1.36	0.048	0.054
D	8.95	9.35	0.352	0.368
E	10.00	10.40	0.393	0.409
G	4.88	5.28	0.192	0.208
L	15.00	15.85	0.590	0.624
L2	1.27	1.40	0.050	0.055
L3	1.40	1.75	0.055	0.069
M	2.40	3.20	0.094	0.126
R	0.40 typ.		0.016 typ.	
V2	0°	8°	0°	8°

**FOOTPRINT DIMENSIONS** (in millimeters)

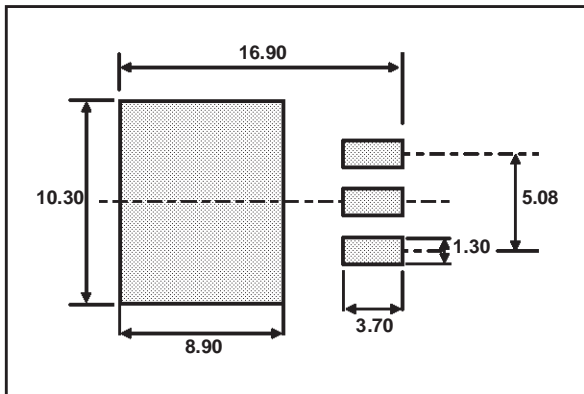

**PACKAGE MECHANICAL DATA**  
TO-247

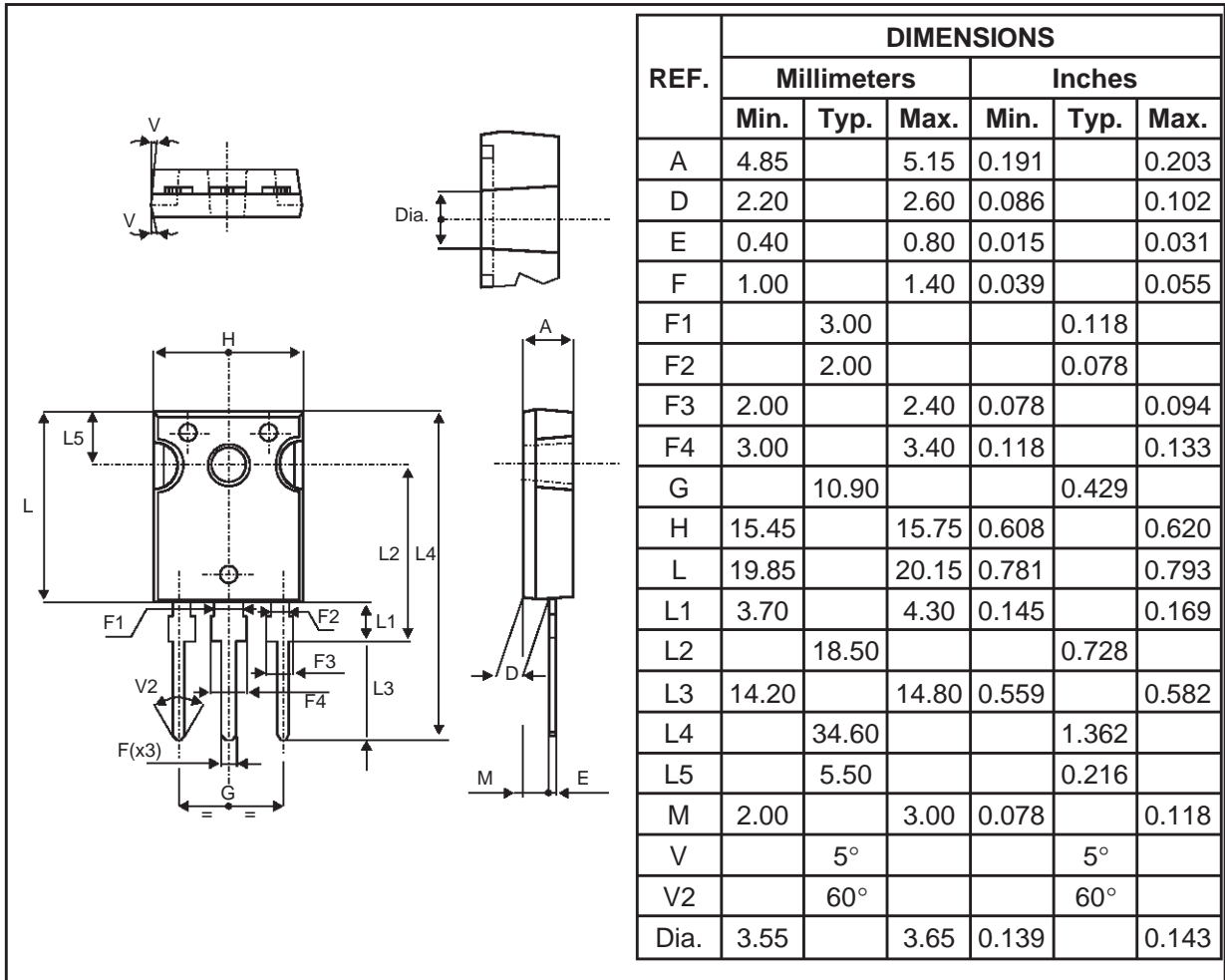

PACKAGE MECHANICAL DATA  
SOT-93

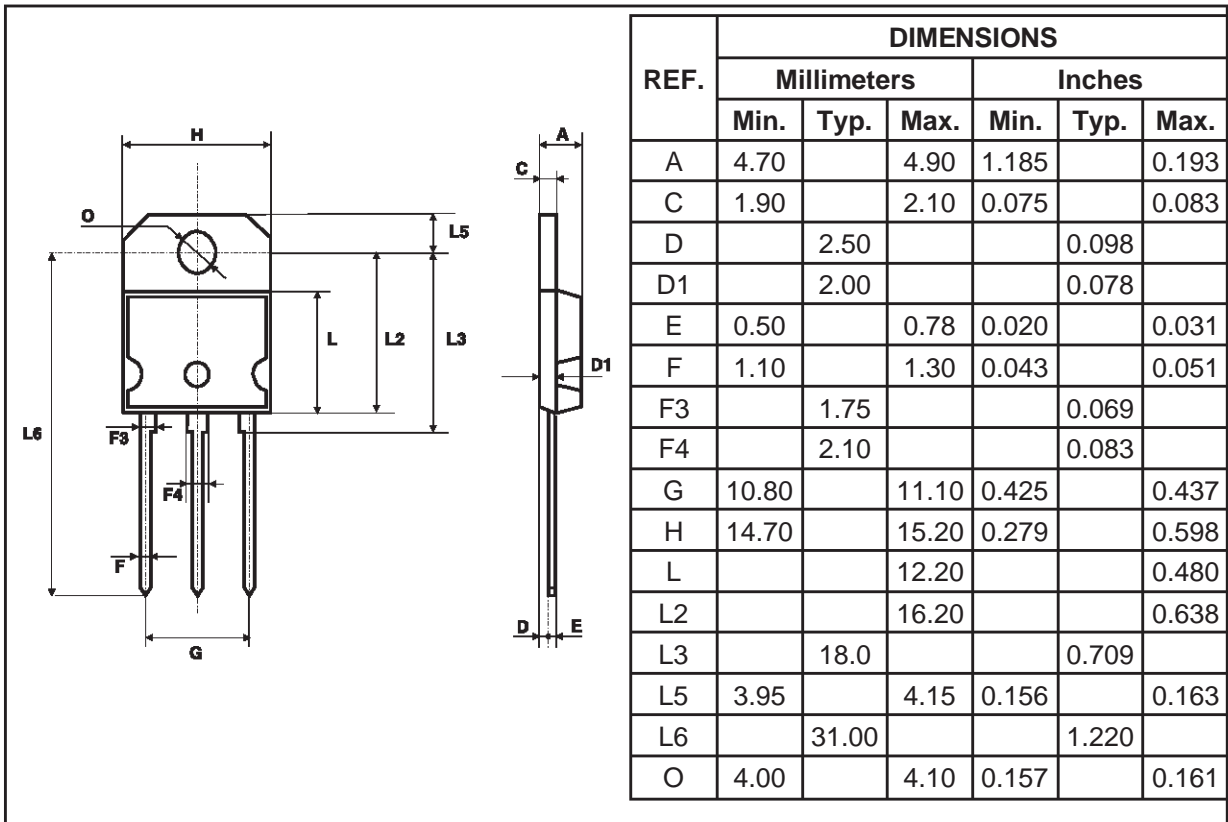



## PACKAGE MECHANICAL DATA

TOP-3I (isolated)

REF.	DIMENSIONS					
	Millimeters			Inches		
	Min.	Typ.	Max.	Min.	Typ.	Max.
A	4.4		4.6	0.173		0.181
B	1.45		1.55	0.057		0.061
C	14.35		15.60	0.565		0.614
D	0.5		0.7	0.020		0.028
E	2.7		2.9	0.106		0.114
F	15.8		16.5	0.622		0.650
G	20.4		21.1	0.815		0.831
H	15.1		15.5	0.594		0.610
J	5.4		5.65	0.213		0.222
K	3.4		3.65	0.134		0.144
L	4.08		4.17	0.161		0.164
P	1.20		1.40	0.047		0.055
R		4.60			0.181	

Type	Marking	Package	Weight	Base qty	Delivery mode
STPS3045CT	STPS3045CT	TO-220AB	2.23 g.	50	Tube
STPS3045CG	STPS3045CG	D <sup>2</sup> PAK	1.48 g.	50	Tube
STPS3045CG-TR	STPS3045CG	D <sup>2</sup> PAK	1.48 g.	1000	Tape & reel
STPS3045CP	STPS3045CP	SOT-93	3.97 g.	30	Tube
STPS3045CPI	STPS3045CPI	TOP-3I	4.46 g.	30	Tube
STPS3045CW	STPS3045CW	TO-247	4.36 g.	30	Tube

- Cooling method: by conduction (C)
- Recommended torque value (SOT-93, TOP-3I, TO-247): 0.8 N.m.
- Recommended torque value (TO-220AB): 0.55 N.m.
- Maximum torque value (SOT-93, TOP-3I, TO-247): 1.0 N.m.
- Maximum torque value (TO-220AB): 0.7 N.m.
- Epoxy meets UL94,V0

Information furnished is believed to be accurate and reliable. However, STMicroelectronics assumes no responsibility for the consequences of use of such information nor for any infringement of patents or other rights of third parties which may result from its use. No license is granted by implication or otherwise under any patent or patent rights of STMicroelectronics. Specifications mentioned in this publication are subject to change without notice. This publication supersedes and replaces all information previously supplied. STMicroelectronics products are not authorized for use as critical components in life support devices or systems without express written approval of STMicroelectronics.

The ST logo is a registered trademark of STMicroelectronics

© 1999 STMicroelectronics - Printed in Italy - All rights reserved.

STMicroelectronics GROUP OF COMPANIES

Australia - Brazil - China - Finland - France - Germany - Hong Kong - India - Italy - Japan - Malaysia  
Malta - Morocco - Singapore - Spain - Sweden - Switzerland - United Kingdom - U.S.A.

<http://www.st.com>

